

HONDA

MARINE

BF40A/50A

Owner's

Manual

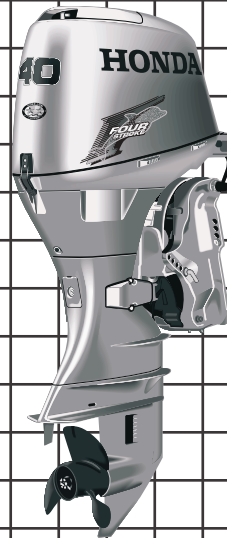

© HONDA MOTOR CO., LTD. 2000

2001

California Proposition 65 Warning

WARNING: Engine Exhaust, some of its constituents, and certain vehicle components contain or emit chemicals known to the State of California to cause cancer and birth defects or other reproductive harm.

Keep this owner's manual handy, so you can refer to it at any time. This owner's manual is considered a permanent part of the outboard motor and should remain with the outboard motor if resold.

The information and specifications included in this publication were in effect at the time of approval for printing. Honda Motor Co., Ltd. reserves the right, however, to discontinue or change specifications or design at any time without notice and without incurring any obligation whatever. No part of this publication may be reproduced without written permission.

Congratulations on your selection of a Honda outboard motor. We are certain you will be pleased with your purchase of one of the finest outboard motors on the market.

We want to help you get the best results from your new outboard motor and to operate it safely. This manual contains the information on how to do that; please read it carefully.

As you read this manual, you will find information preceded by a **NOTICE** symbol. That information is intended to help you avoid damage to your outboard motor, other property, or the environment.

We suggest you read the warranty policy to fully understand its coverage and your responsibilities of ownership. The warranty policy is a separate document that should have been given to you by your dealer.

When your outboard motor needs scheduled maintenance, keep in mind that your Honda marine dealer is specially trained in servicing Honda outboard motors. Your Honda marine dealer is dedicated to your satisfaction and will be pleased to answer your questions and concerns.

© 2000 Honda Motor Co., Ltd.
All Right Reserved

INTRODUCTION

A FEW WORDS ABOUT SAFETY

Your safety and the safety of others are very important. And using this outboard motor safely is an important responsibility.



To help you make informed decisions about safety, we have provided operating procedures and other information on labels and in this manual. This information alerts you to potential hazards that could hurt you or others.

Of course, it is not practical or possible to warn you about all the hazards associated with operating or maintaining an outboard motor. You must use your own good judgment.

You will find important safety information a variety of forms, including:

- **Safety Labels** — on the outboard motor.
- **Safety Messages** — preceded by a safety alert symbol  and one of three signal words, **DANGER**, **WARNING**, or **CAUTION**.

These signal words mean:

 DANGER	You WILL be KILLED or SERIOUSLY HURT if you don't follow instructions.
 WARNING	You CAN be KILLED or SERIOUSLY HURT if you don't follow instructions.
 CAUTION	You CAN be HURT if you don't follow instructions.

- **Safety Headings** — such as **IMPORTANT SAFETY INFORMATION**.
- **Safety Section** — such as **OUTBOARD MOTOR SAFETY**.
- **Instructions** — how to use this outboard motor correctly and safely.

This entire book is filled with important safety information — please read it carefully

TYPES OF HONDA BF40A/50A OUTBOARD MOTORS

It may be necessary to refer to this chart for reference purposes when reading this manual.

Model	Type	Shaft Length		Tiller Handle	Remote Control	Gas Assisted Tilt	Power Trim/Tilt	Tachometer	Trimmeter
		L	X						
BF40A	LH	●		●		●			
	LR	●			●	●			
	LHT	●		●			●	●	●
	LRT	●			●		●	●	●
	XRT		●		●		●	●	
BF50A	LR	●			●	●			
	LHT	●		●			●	●	●
	LRT	●			●		●	●	●
	XRT		●		●		●	●	

TYPE CODE (example)

L R T T = Power Trim/Tilt R = Remote Control R = Tiller Handle X = Extra Long Shaft L = Long Shaft

IDENTIFICATION NUMBERS

RIGHT STERN BRACKET



PRODUCT IDENTIFICATION NUMBER

Record the Product Identification Number (P.I.N.) and the Engine Serial Number for your reference. Refer to the Product Identification Number when ordering parts, and when making technical or warranty inquiries (see page 110).

STARTER MOTOR



ENGINE SERIAL NUMBER

The Product Identification Number is stamped on a plate and attached to the right stern bracket. The Engine Serial Number is stamped on the cylinder block under the starter motor which is located in the front of the engine.

Product identification number:

Engine serial number:

1. OUTBOARD MOTOR SAFETY		
IMPORTANT SAFETY INFORMATION	7	
SAFETY LABEL LOCATIONS	9	
2. COMPONENT IDENTIFICATION	10	
3. CONTROLS		
TILLER HANDLE TYPE		
Engine Start Button	13	
Shift Lever	13	
Choke Knob	13	
Throttle Grip	14	
Throttle Opening Indicator	14	
Throttle Friction Knob	14	
Engine Stop Switch	15	
Emergency Stop Switch Lanyard	15	
Oil Pressure Indicator Light	16	
Overheat Indicator Light	16	
REMOTE CONTROL TYPE		
Remote Control Lever	17	
Neutral Release Lever	18	
Ignition Switch	18	
Emergency Stop Switch Lanyard	19	
Choke/Fast Idle Lever	20	
Manual Choke Knob	20	
Oil Pressure Indicator Light/Buzzer	21	
Overheat Indicator Light/Buzzer	21	
POWER TRIM/TILT TYPE		
Power Trim/Tilt Switch	22	
Power Tilt Switch (motor pan)	23	
Trim Meter	23	
		Tachometer
		Manual Relief Valve
		GAS ASSISTED TILT TYPE
		Tilt Lever
		CONTROLS (COMMON)
		Tilt Lock Lever
		Trim Tab
		Anode Metal
		Cooling System Indicator
		Water Intakes
		Transom Angle Adjusting Rod
		Fuel Cap/Gauge/Vent Knob
		Over-Rev Limiter
		4. PRE-OPERATION CHECKS
		Engine Cover Removal/Installation
		Engine Oil
		Fuel Level
		Fuel Recommendations
		Oxygenated Fuels
		Propeller and Coner Pin
		Steering Friction Adjustment (common)
		Remote Control Friction Adjustment
		Other Checks
		• Stern Bracket
		• Tool Kit
		• Anodes
		5. STARTING THE ENGINE
		Fuel Tank and Vent Knob

CONTENTS

Fuel Line Connection	38	High Altitude Operation	73
STARTING THE ENGINE (TILLER HANDLE TYPE) ...	40	7 STOPPING THE ENGINE	
STARTING THE ENGINE (REMOTE CONTROL TYPE) ...	44	TILLER HANDLE TYPE	74
Emergency Starting	47	REMOTE CONTROL TYPE	76
Troubleshooting Starting Problems	52	8. TRANSPORTING	77
6. OPERATION		9. CLEANING AND FLUSHING	78
Break-in Procedure	53	10. MAINTENANCE	80
TILLER HANDLE TYPE		THE IMPORTANCE OF MAINTENANCE	80
Gear Shifting	54	MAINTENANCE SAFETY	80
Steering	55	EMISION CONTROL SYSTEM INFORMATION ...	81
Cruising	55	STAR LABEL	84
REMOTE CONTROL TYPE		Tool Kit and Spare Parts	86
Gear Shifting	57	MAINTENANCE SCHEDULE	87
Cruising	58	Engine Oil	89
Tilting Motor		Gear Oil	91
GAS ASSISTED TILT TYPE	59	Spark Plugs	94
POWER TRIM/TILT TYPE	62	Battery (not included)	94
POWER TRIM/TILT TYPE		Lubrication	95
Trim Meter	64	Engine Fuel Filter	96
Power Tilt Switch (Motor Pan)	65	Fuel Tank and Filter	98
Manual Relief Valve	65	Fuse Replacement	99
Tilt Lock Lever	66	Propeller	100
Trim Tab Adjustment	67	Submerged Motor	101
MOTOR PROTECTION SYSTEM		11. STORAGE/WINTERIZATION	103
Engine Oil Pressure and Overheat Warning System ...	68	12. TROUBLESHOOTING	105
Over-Rev Limiter	70	13. SPECIFICATIONS	107
Power Trim Warning System	70	14. WARRANTY SERVICE	110
Anodes	71	15. WIRING DIAGRAM	111
Shallow Water Operation	72	16. INDEX	114

1. OUTBOARD MOTOR SAFETY

IMPORTANT SAFETY INFORMATION

Honda BF40A and BF50A outboard motors are designed for use with boats that have a suitable manufacturer's power recommendation, and other uses can result in injury to the operator or damage to the outboard motor and other property.

Most accidents can be prevented if you follow all instructions in this manual and on the outboard motor. The most common hazards are discussed below, along with the best way to protect yourself and others.

Operator Responsibility

- It is the operator's responsibility to provide the necessary safeguards to protect people and property. Know how to stop the engine quickly in case of emergency. Understand the use of all controls.
- Stop the engine immediately if anyone falls overboard, and do not run the engine while the boat is near anyone in the water.
- Always stop the engine if you must leave the controls for any reason.
- Attach the emergency stop switch lanyard securely to the operator.

- Always wear a PFD (Personal Flotation Device) while on the boat.
- Familiarize yourself with all laws and regulations relating to boating and the use of outboard motors.
- Be sure that anyone who operates the outboard motor receives proper instruction.
- Be sure the outboard motor is properly mounted on the boat.
- Do not remove the engine cover while the engine is running.
- Do not attempt to modify the outboard motor.
- Do not remove any labels, covers, or safety devices; they are installed for your safety.

1. OUTBOARD MOTOR SAFETY

Refuel With Care

- ◆ Gasoline is extremely flammable, and gasoline vapor can explode. Refuel outdoors, in a well-ventilated area, with the engine stopped. Never smoke near gasoline, and keep other flames and sparks away.
- ◆ Remove any portable fuel tank from the boat for refueling. Keep the portable fuel tank away from the battery or other potential spark sources.
- ◆ Refuel carefully to avoid spilling fuel. Avoid overfilling the fuel tank.
- ◆ After refueling, tighten the filler cap securely. If any fuel is spilled, make sure the area is dry before starting the engine.

Carbon Monoxide Hazard

Exhaust gas contains poisonous carbon monoxide. Avoid inhalation of exhaust gas. Never run the engine in a closed garage or confined area.

1. OUTBOARD MOTOR SAFETY

SAFETY LABEL LOCATIONS

These labels are in the locations shown. They warn you of potential hazards that could seriously injure you. Read these labels carefully.

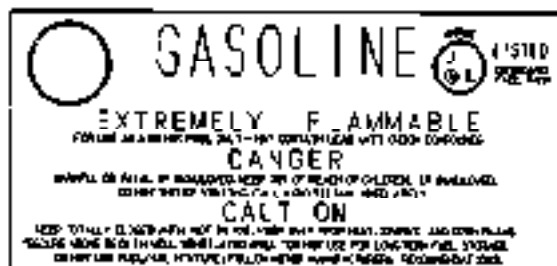
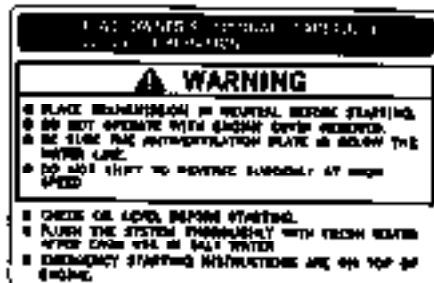

2. COMPONENT IDENTIFICATION (TILLER HANDLE TYPE)

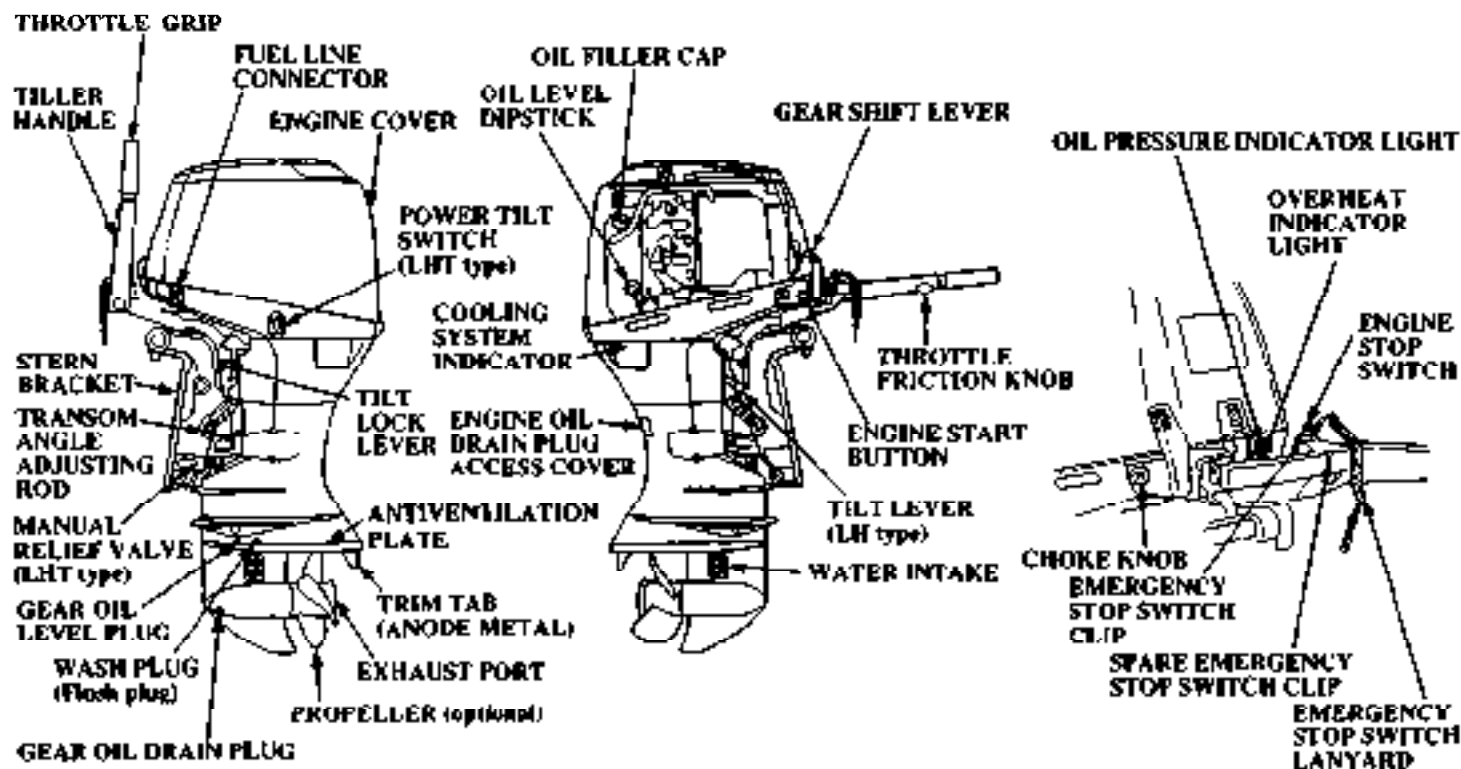

2. COMPONENT IDENTIFICATION (REMOTE CONTROL TYPE)

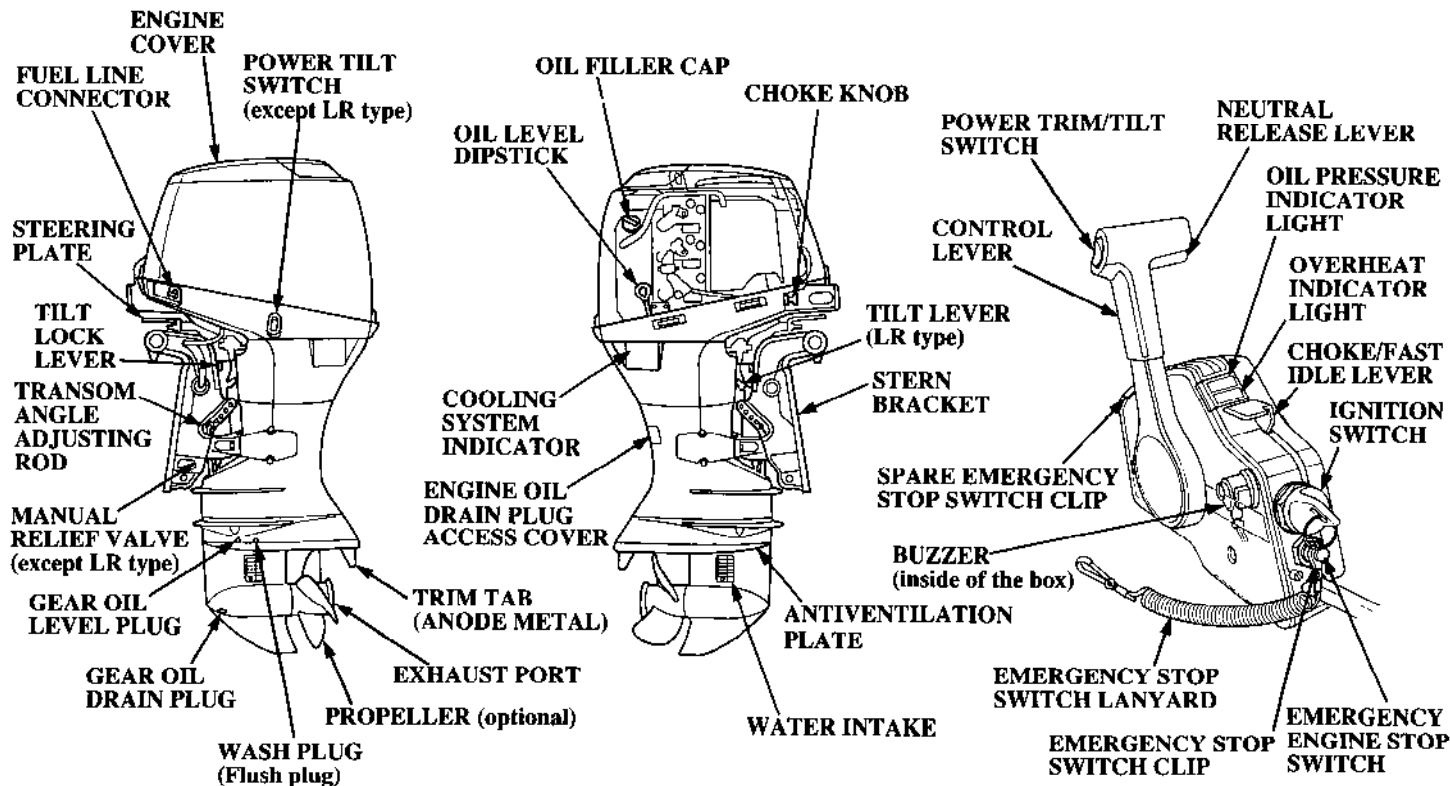

2. COMPONENT IDENTIFICATION

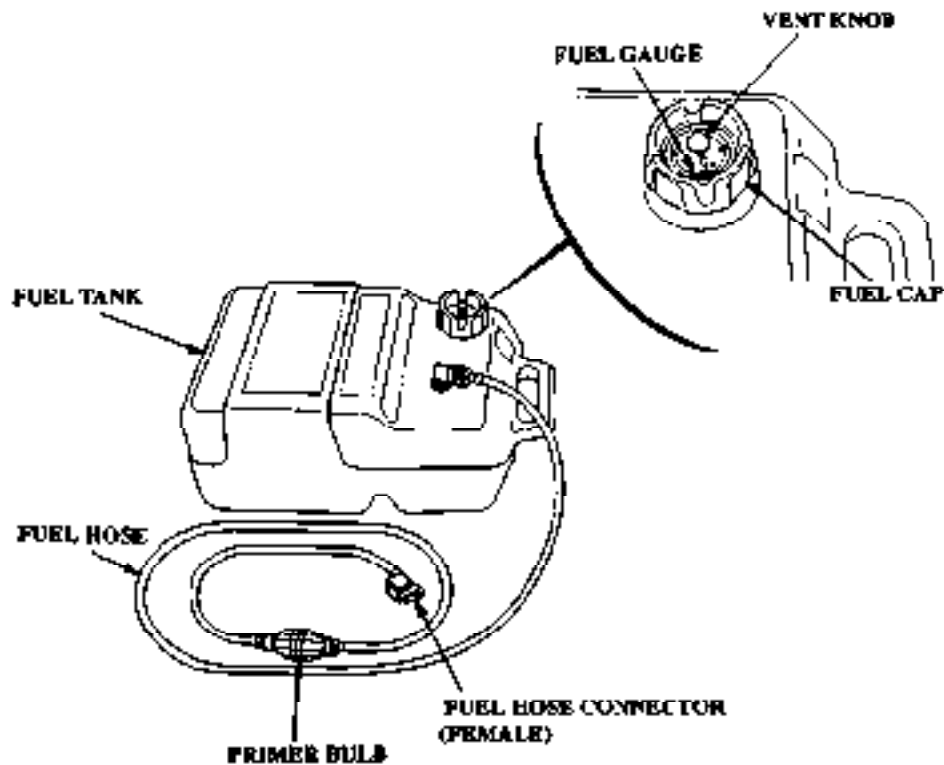

POWER TRIM/TILT TYPES



TACHOMETER



TRIM METER

3. CONTROLS (TILLER HANDLE TYPE)

Engine Start Button

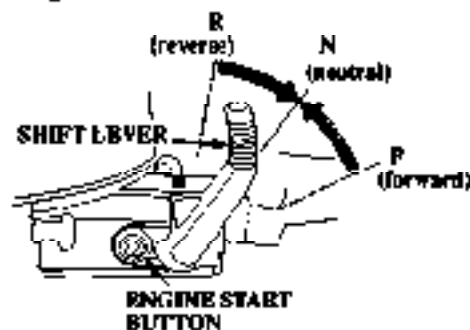

Move the gearshift lever to the N (neutral) position before starting. The engine will not start unless the gearshift lever is in the N (neutral) position.

Shift Lever

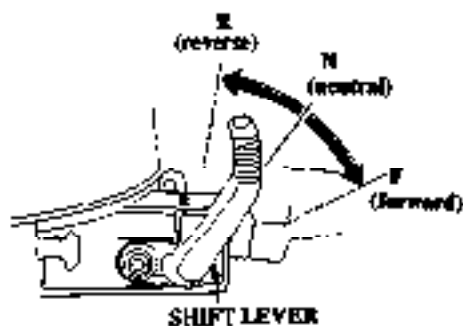

There are three gearshift lever positions.

F (forward): The boat moves forward.

N (neutral): The transmission gears are disengaged from the engine.

R (reverse): The boat reverses.

Choke Knob



When the engine is cold, pull the choke knob. A rich fuel mixture is provided to the engine by pulling the choke knob.

3. CONTROLS (TILLER HANDLE TYPE)

Throttle Grip

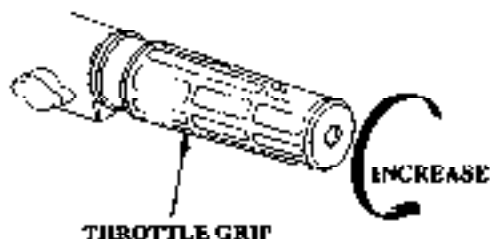

Turn the grip clockwise or counterclockwise to adjust the engine speed. Turning the grip in the direction shown by the arrow increases engine speed.

Throttle Opening Indicator

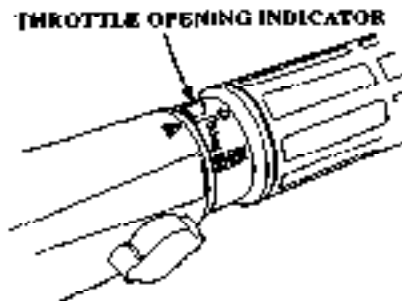

The label on the grip indicates throttle opening.

Throttle Friction Knob

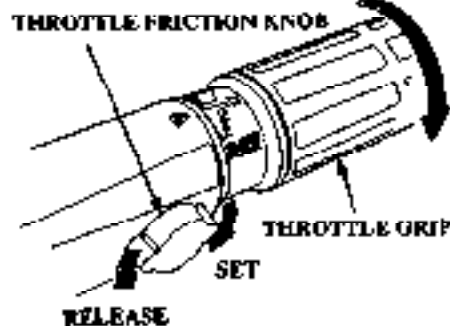

Use the throttle friction knob to set the throttle grip at a certain position while cruising. Turning the friction knob clockwise sets the throttle grip, and it is released by turning the friction knob counterclockwise.

3. CONTROLS (TILLER HANDLE TYPE)

Engine Stop Switch

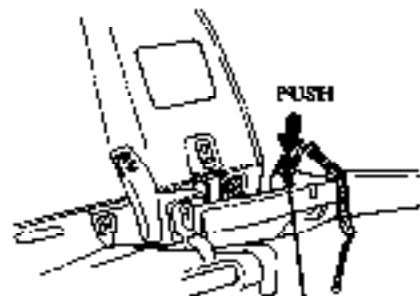

ENGINE STOP SWITCH

Push the engine stop switch to stop the engine.

Emergency Stop Switch Lanyard

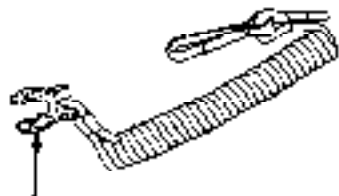

EMERGENCY STOP SWITCH CLIP

The emergency stop switch lanyard is provided to stop the engine immediately in the event the operator should fall overboard or away from the controls.

The emergency stop switch clip must be engaged with the engine stop switch or the engine will not start. When the emergency stop switch clip becomes disengaged from the engine stop switch, the engine will stop immediately.

ENGINE STOP SWITCH



EMERGENCY STOP SWITCH LANYARD

Attach the emergency stop switch lanyard securely to the operator when operating the outboard motor.

3. CONTROLS (TILLER HANDLE TYPE)

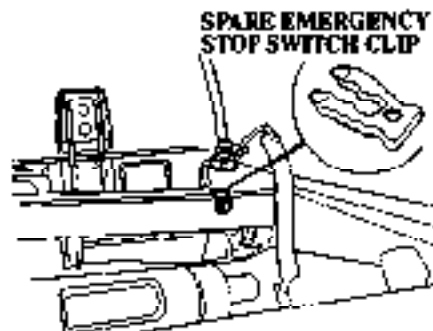

A spare emergency stop switch clip is provided near the engine stop switch.

Oil Pressure Indicator Light

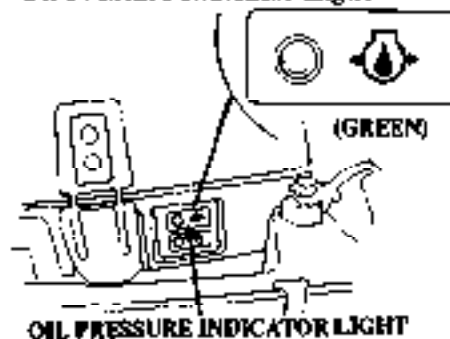

The green oil pressure indicator light is normally ON when the onboard motor is running. When the engine oil level is low or the engine lubrication system is faulty, the green oil pressure indicator light turns OFF and the engine speed decreases gradually.

Overheat Indicator Light

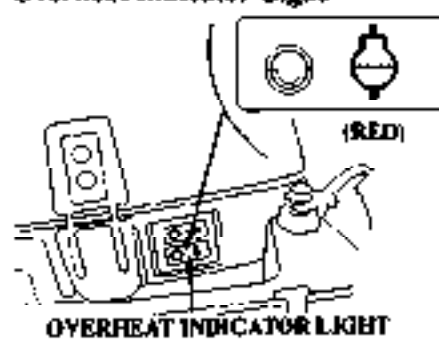

When the engine cooling system is faulty, the red overheat indicator light turns ON and the engine speed decreases gradually.

3. CONTROLS (REMOTE CONTROL TYPE)

Remote Control Lever

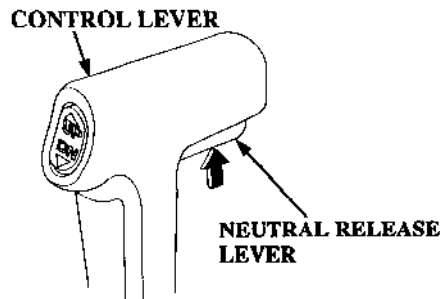

The remote control lever controls gear selection and throttle opening positions.

It is necessary to pull up the neutral release lever to operate the remote control lever.

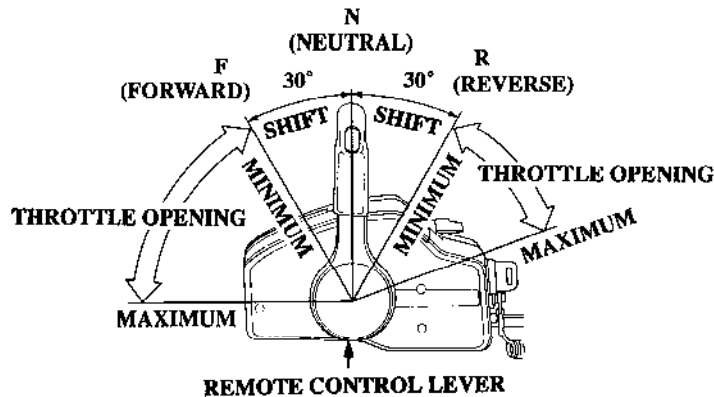

F (forward):

Moving the lever to the F position (approximately 30° from the N position) will engage the forward gear. Moving the lever beyond the F position will increase the throttle opening and the boat forward speed.

N (neutral):

The transmission gears are disengaged.

R (reverse):

Moving the lever to the R position (approximately 30° from the N position) will engage the reverse gear. Moving the lever beyond the R position will increase the throttle opening and the boat reverse speed.

3. CONTROLS (REMOTE CONTROL TYPE)

Neutral Release Lever

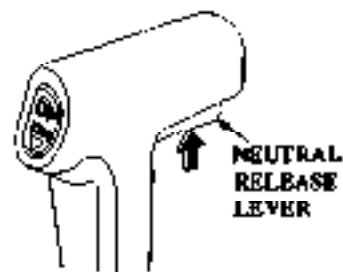

The neutral release lever is on the remote control lever to prevent an accidental gear engagement.

The remote control lever will not engage forward or reverse gear unless the neutral release lever is pulled up.

Ignition Switch

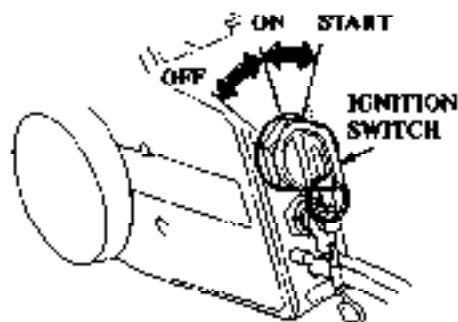

The remote control box is equipped with a key type ignition switch. Key positions:

START

To activate the starter motor and start the engine. (the remote control lever must be in the neutral position)

ON

To run the engine after starting (the battery will discharge if the key is left in this position with the engine not running).

OFF

To stop the engine (IGNITION OFF).

To prevent the battery from discharging, keep the key in the OFF position when the engine is not running.

3. CONTROLS (REMOTE CONTROL TYPE)

Emergency Stop Switch Lanyard

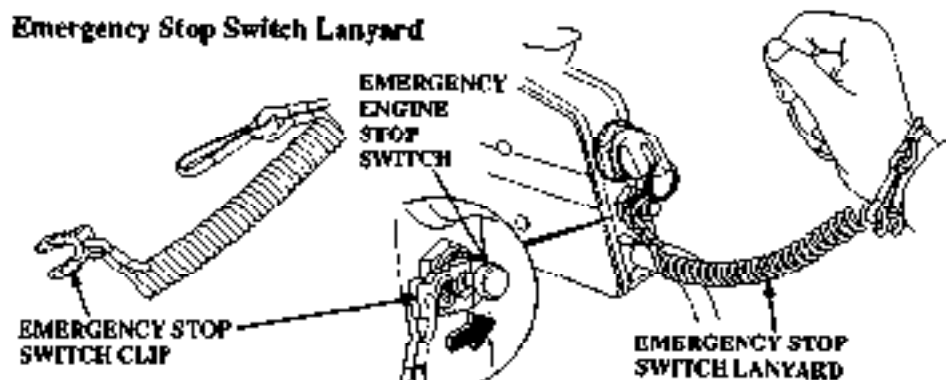

The emergency stop switch lanyard is provided to stop the engine immediately in the event the operator should fall overboard or away from the controls.

The emergency stop switch clip must be engaged with the emergency engine stop switch or the engine will not start. When the emergency stop switch clip becomes disengaged from the emergency engine stop switch the engine will stop immediately.

The emergency engine stop switch should not be used to normally stop the engine. Use the ignition switch to normally stop the engine.

Attach the emergency stop switch lanyard securely to the operator when operating the outboard motor.

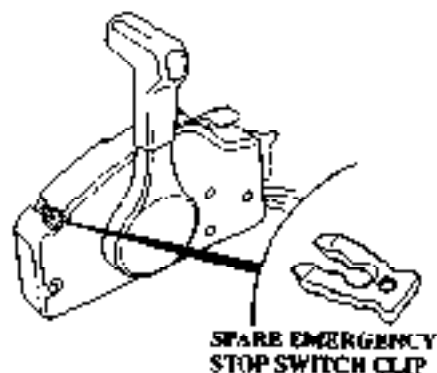

A spare emergency stop switch clip is provided on the remote control box.

3. CONTROLS (REMOTE CONTROL TYPE)

Choke/Fast Idle Lever

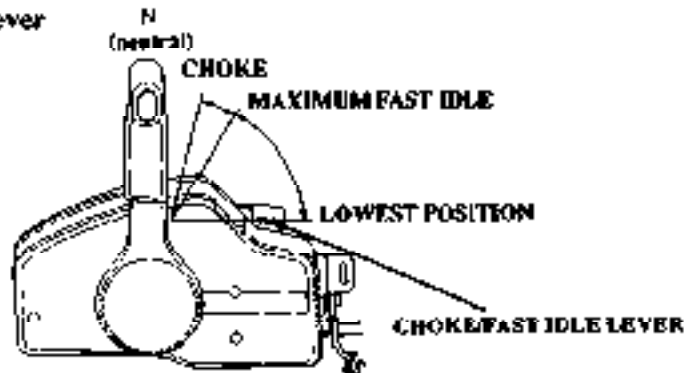

The choke/fast idle lever provides two functions:

1. Electric choke solenoid activation for easy engine start up.
2. Engine fast idle.

The choke/fast idle lever will not move unless the remote control lever is in the N (neutral) position. Conversely, the remote control lever will not move unless the choke/fast idle lever is in the lowest position.

Lift and hold the choke/fast idle lever up fully, this will provide a rich fuel mixture.

Gradually lower the choke/fast idle lever to the lowest position to disengage the choke and lower the idle speed.

Manual Choke Knob

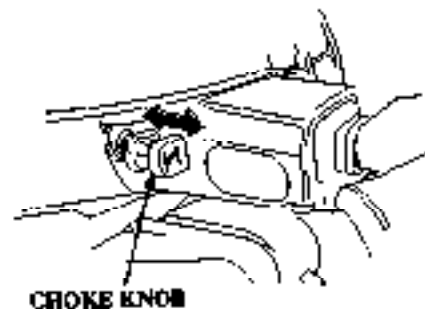

A manual choke knob is provided on the right side of the motor which can be used in the event the battery is discharged. Pull the manual choke knob, and a rich fuel mixture will be provided to the engine.

3. CONTROLS (REMOTE CONTROL TYPE)

Oil Pressure Indicator Light/Buzzer

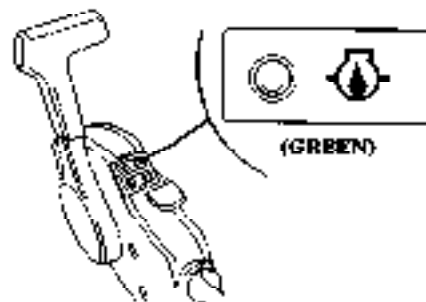

The green oil pressure indicator light turns OFF and the buzzer sounds when the oil level is low and/or the engine lubrication system is faulty. The engine speed slows down gradually.

Overheat Indicator Light/Buzzer

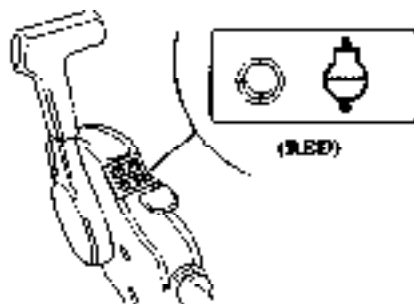

The red overheat indicator light turns ON and the buzzer sounds when the engine cooling system is faulty. The engine speed slows down gradually.

3. CONTROLS (POWER TRIM/TILT TYPE)

Power Trim/Tilt Switch

Power Trim

Press the power trim/tilt switch on the remote control lever (remote control type) to adjust the motor trim angle of 0° to 20° to maintain proper boat trim. The power trim/tilt switch located on the remote control lever (remote control type) can be operated while the boat is under way or while stopped.

By using the power trim/tilt switch the operator can change the trim angle of the motor to achieve maximum boat acceleration, speed, stability and maintain optimum fuel consumption.

Power Tilt

Press the power trim/tilt switch on the remote control lever (remote control type) to adjust the motor tilt angle of 20° to 60°. By using the power trim/tilt switch the operator can change the tilt angle of the motor for shallow water operation, beaching, launching from a trailer, or mooring.

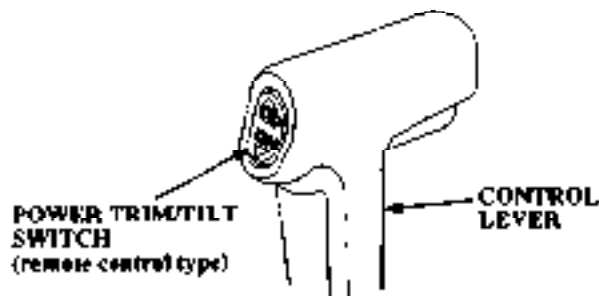

On the tiller handle type, the power trim/tilt switch is the optional part. The power trim/tilt switch is available on your authorized Honda Marine dealer.

NOTICE Excessive trim/tilt angle during operation can cause the propeller to raise out of the water and cause propeller ventilation and engine over-revving. Excessive trim/tilt angle can also damage the water pump.

3. CONTROLS (POWER TRIM/TILT TYPE)

XRTA type outboard

Power Trim

Do not trim this engine when you are using a large amount of throttle opening. If you do try to trim the engine (for example, wide open throttle), under certain conditions, propeller thrust may override the power trim hydraulics and cause the engine to return to the transom angle adjusting rod. (Full "in" position)

Power TIL

Press the power tilt switch on the remote control lever to adjust the motor tilt angle of 20° to 60°.

By using the power tilt switch the operator can change the tilt angle of the motor for shallow water operation, beaching, launching from a trailer, or mooring.

Power Tilt Switch (motor pan)



POWER TILT SWITCH

The power tilt switch located on the motor pan is a convenience switch for tilting the motor for trailering, or performing outboard maintenance. This power tilt switch should only be operated with the boat is stopped and motor off.

Trim Meter



TRIM METER

The trim meter has a range of 0° to 20° and indicates the trim angle of the outboard motor. Refer to the trim meter when using the power trim/tilt switch to achieve proper boat performance.

3. CONTROLS (POWER TRIM/TILT TYPE)

Tachometer



TACHOMETER

The tachometer shows the approximate engine speed in revolutions per minute. Refer to the tachometer when using the power trim/tilt switch to achieve proper boat and motor performance.

Manual Relief Valve

If the power trim/tilt switch will not tilt the outboard motor, the motor can be manually tilted up or down by opening the manual relief valve. To tilt the outboard motor manually, turn the manual valve under the left stern bracket no more than 1 or 2 turns counterclockwise using a screw driver. After tilting the motor, turn the manual relief valve clockwise securely. The manual relief valve must be tightened securely before operating the motor or the motor could tilt up when operating in reverse.

LEFT STERN BRACKET

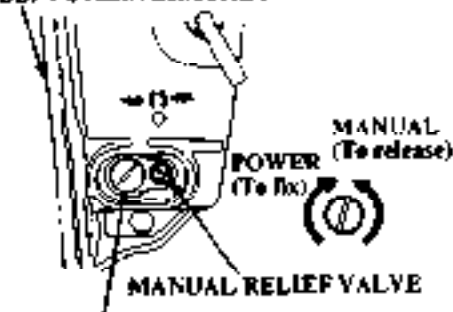

Do not turn this screw. If this screw is turned hydraulic oil will bleed out of the power trim/tilt system. Should this happen it will be necessary to consult your authorized Honda Marine dealer and have the system refilled.

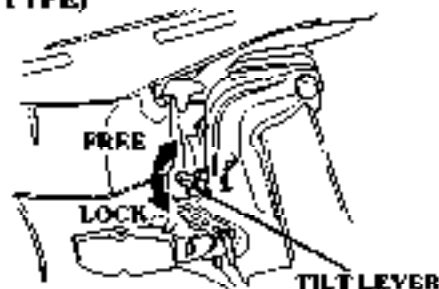
Tilt Lever (GAS ASSISTED TYPE)

Moving the tilt lever to the FREE position allows the motor to be tilted and moving the tilt lever to the LOCK position locks the motor in the desired position. Use the tilt lever to temporarily tilt the motor when the boat is operating in shallow water, or mooring in shallow water. The tilt lever must be in the LOCK position before operating the motor or the motor could tilt up when operating in reverse.

Tilt Lock Lever

Use the tilt lock lever to hold the motor in the highest tilt position when the boat is moored for a long time. Tilt the motor up as far as it will go then move the tilt lock lever into the lock position and gently lower the motor.

Trim Tab

When making a turn, if an unequal amount of effort is required to turn the steering wheel or tiller handle right or left, adjust the trim tab so that an equal amount of effort is required (refer to page 67).

3. CONTROLS (COMMON)

Distribute the load evenly in the boat and run the boat in straight course at full throttle. Slightly turn the steering wheel or tiller handle for both right and left trims to determine if an equal amount of effort is required. If adjustment is necessary loosen the tightening bolt and turn the trim tab right or left. Make small adjustments at a time and retest. Incorrect trim tab adjustment can cause adverse steering. The trim tab also functions as an anode.

Anode Metal

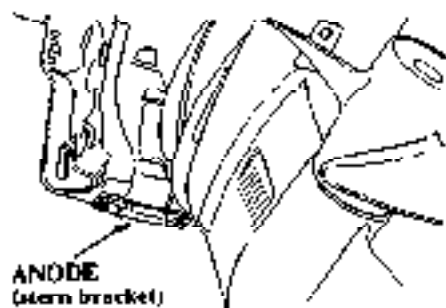
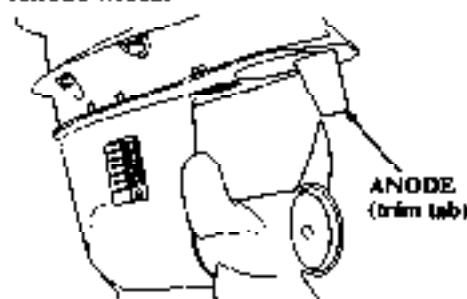

The anodes are made from a sacrificial material which helps to protect the outboard motor from corrosion.

NOTICE *Painting or coating the anodes will lead to rust and corrosion damage to the outboard motor.*

Cooling System Indicator

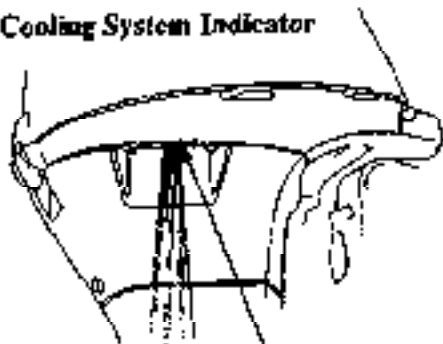

COOLING SYSTEM INDICATOR

The cooling system is monitored here to make sure cooling water is circulating through the engine.

Water Intakes

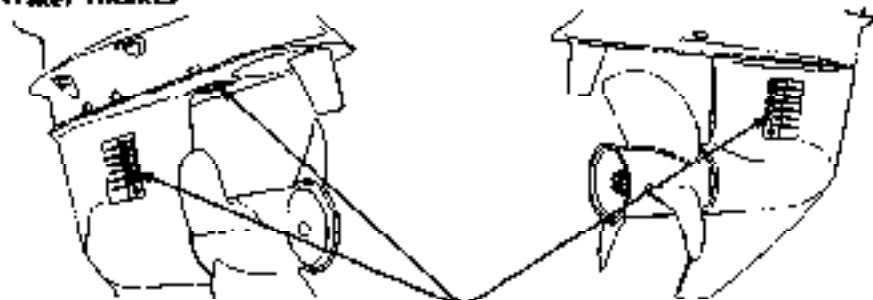

WATER INTAKES

The engine cooling water is drawn into the water pump through these water intakes

3. CONTROLS (COMMON)

Transom Angle Adjusting Rod

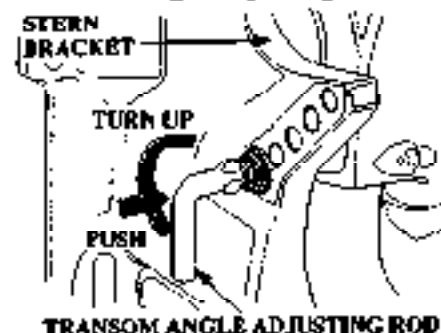

The transom angle adjusting rod is used to adjust the motor angle to achieve the correct boat trim. There are 5 adjustment holes located in the stern bracket.

Push in and turn the transom angle adjusting rod up to remove. To install insert into the proper hole and turn down to lock. After installation pull the transom angle adjusting rod outward to be sure it is locked in place. Start with the transom angle adjusting rod in the hole closest to the boat tran-

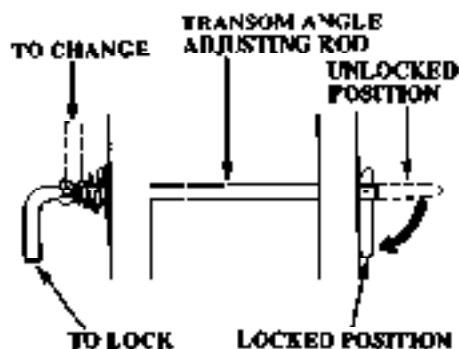

som, lower the motor and operate the boat at full speed. If the bow is excessively low stop the boat. Tilt the motor up and raise the transom angle adjusting rod one more hole away from the transom and reset. The optimum boat trim is when the boat is parallel with the water. The transom angle adjusting rod stops the motors forward movement.

The motor should never be operated with the transom angle adjusting rod removed.

Fuel Cap/Gauge/Vent Knob

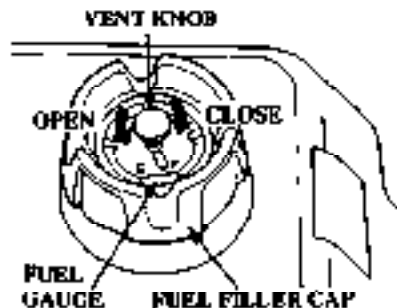

The fuel gauge is part of the fuel cap.

The fuel cap vent knob controls air entering and leaving the fuel tank. When refilling the fuel tank, turn the vent knob counterclockwise to the open position and remove the fuel cap.

Before transporting, storing or refilling the fuel tank inspect the condition of the fuel cap gasket and replace if necessary.

Before transporting or storing the fuel tank turn the vent knob fully clockwise to the closed position. Anytime the fuel tank is in the boat with the vent knob closed, disconnect the fuel hose connector from the outboard motor (refer to page 38)

WARNING: Gasoline is extremely flammable, and gasoline vapor can explode, causing serious injury or death. Do not smoke or allow flames or sparks in your working area. **KEEP OUT OF REACH OF CHILDREN.**

Over-Rev Limiter

This outboard motor is equipped with an engine over-rev limiter which limits the maximum engine rpm. This over-rev limiter protects the engine from mechanical damage.

The over-rev limiter may be activated by putting the propeller in a light load condition or propeller ventilation. When the over-rev limiter is activated the engine rpm will become unstable or erratic. Should this occur reduce the throttle opening and wait for the engine rpm to stabilize then slowly increase the throttle opening.

On the power trim/tilt type motors lower the trim angle on high speed turns to reduce the possibility of propeller ventilation.

4. PRE-OPERATION CHECKS

Engine Cover Removal/Installation

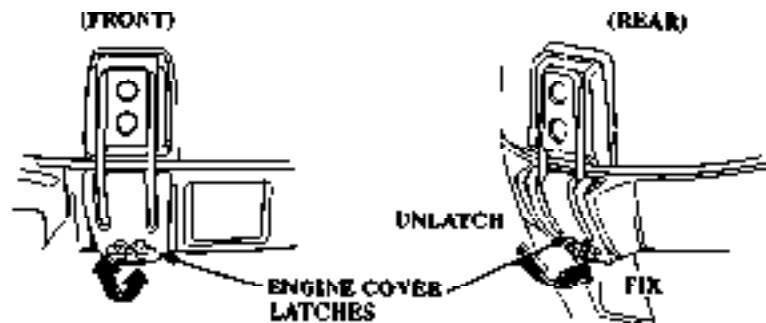

To remove, release the front and rear engine cover latches and remove the engine cover.

To install, position the engine cover over the engine and hook and lock the front and rear latches.

4. PRE-OPERATION CHECKS

Engine Oil

Engine oil is a major factor affecting engine performance and service life.

NOTICE Running the engine with insufficient oil can cause serious engine damage.

Recommended oil

Use high-detergers, premium quality 4-stroke engine oil, certified to meet or exceed U.S. automobile manufacturers' requirements for American Petroleum Institute (API) Service Classification SG, SH. Engine oils classified SG, SH will show these designations on the container.

Select the appropriate viscosity for the average temperature in your area.

SAE 5W-30 is recommended for general, all-temperature use (BF40A/50A).
API Service Grade: Use a Fuel Efficient SG, SH oil.

NOTE: This oil is usually identified by words such as: "Energy Conserving II," "Gas Saving," "Fuel Saving," etc.



Inspection

1. Position the outboard motor vertically, and remove the engine cover.
2. Remove the oil level dipstick and wipe with a clean rag.
3. Reinsert the dipstick all the way in, then pull it out and read the level. If the oil registers near or below the lower limit mark, remove the oil filler cap and fill to the upper level mark with the recommended oil.

NOTICE Do not overfill. Excessive oil can damage the engine.

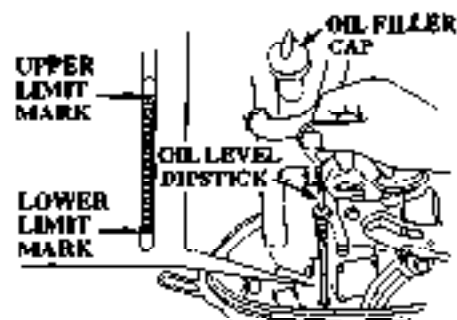

4. Reinstall the oil filler cap and tighten securely.
5. Install the engine cover and lock it securely.

When the engine oil is contaminated or discolored, replace with fresh engine oil (refer to page 89 for oil capacity, replacement interval and procedure).

4. PRE-OPERATION CHECKS

Fuel Level

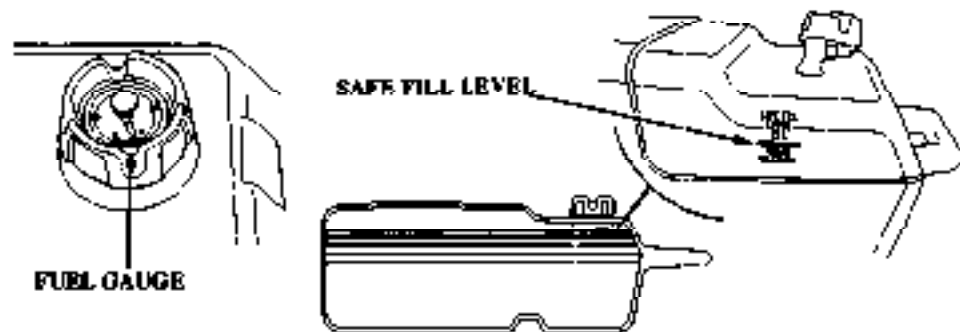

Check the fuel gauge and refill the tank to the SAFE FILL level mark if necessary.

Fuel tank capacity:
6.6 US gal (25 l, 5.5 Imp gal)

WARNING Gasoline is extremely flammable, and gasoline vapor can explode, causing serious injury or death. Do not smoke or allow flames or sparks in your working area. **KEEP OUT OF REACH OF CHILDREN.**

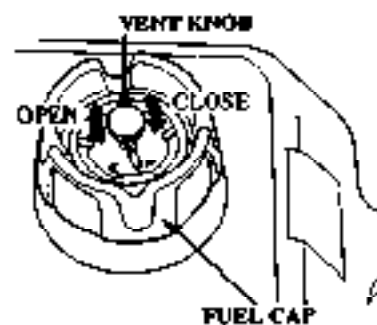

Refilling

Remove the fuel tank from the boat for refilling. Turn the vent knob counterclockwise to the open position and remove the fuel cap.

Refuel in a well-ventilated area. Fill the fuel tank up to the SAFE FILL level mark only. Inspect the condition of the fuel cap gasket and replace if necessary.

After refilling, install and tighten the fuel cap securely. Turn the vent knob clockwise to the closed position. Return the fuel tank to the boat.

Fuel Recommendations

Use unleaded gasoline with a pump octane rating of 86 or higher.

These outboard motors are certified to operate on unleaded gasoline. Unleaded gasoline produces fewer engine and spark plug deposits and extends exhaust system life.

Never use stale or contaminated gasoline or an oil/gasoline mixture. Avoid getting dirt or water in the fuel tank.

Occasionally you may hear light "spark knock" or "pinging" (metallic rapping noise) while operating under heavy loads. This is no cause for concern.

If spark knock or pinging occurs at a steady engine speed, under normal load, change brands of gasoline. If spark knock or pinging persists, see an authorized Honda Marine dealer.

[NOTICE] *Running the engine with persistent spark knock or pinging can cause engine damage.*

Running the engine with persistent spark knock or pinging is misuse, and the *Distributor's Limited Warranty* does not cover parts damage by misuse.

4. PRE-OPERATION CHECKS

Oxygenated Fuels

Some conventional gasolines are being blended with alcohol or an ether compound. These gasolines are collectively referred to as oxygenated fuels. To meet clean air standards, some areas of the United States and Canada use oxygenated fuels to help reduce emissions.

If you use an oxygenated fuel, be sure it is unleaded and meets the minimum octane rating requirement.

Before using an oxygenated fuel, try to confirm the fuel's contents. Some states/provinces require this information to be posted on the pump.

The following are the EPA approved percentages of oxygenates:

ETHANOL — (ethyl or grain alcohol) 10% by volume
You may use gasoline containing up to 10% ethanol by volume. Gasoline containing ethanol may be marketed under the name "Gasohol".

MTBE — (Methyl Tertiary Butyl Ether) 15% by volume
You may use gasoline containing up to 15% MTBE by volume.

METHANOL — (methyl or wood alcohol) 5% by volume
You may use gasoline containing up to 5% methanol by volume, as long as it also contains solvents and corrosion inhibitors to protect the fuel system. Gasoline containing more than 5% methanol by volume may cause starting and/or performance problems. It may also damage metal, rubber, and plastic parts of your fuel system.

If you notice any undesirable operating symptoms, try another service station, or switch to another brand of gasoline.

Fuel system damage or performance problems resulting from the use of an oxygenated fuel containing more than the percentages of oxygenates mentioned above are not covered under warranty.

Propeller and Cotter Pin

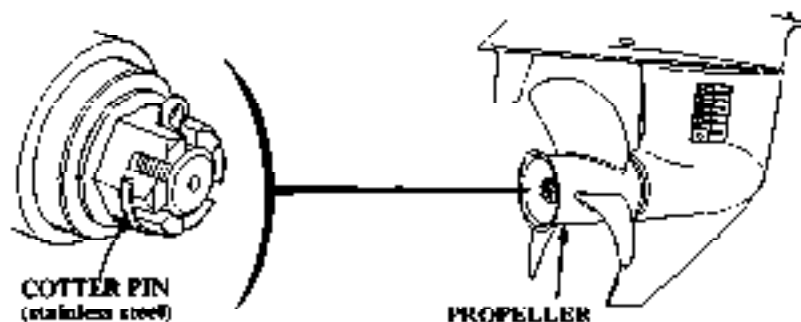

WARNING The propeller blades are thin and sharp. Careless handling of the propeller can result in injury when checking the propeller:

- Remove the clip of the emergency stop switch to prevent accidental engine starting.
- Wear heavy gloves when handling the propeller.

Propeller

Check the propeller blades for damage, wear or deformation and replace if necessary. Never operate the outboard motor with a damaged propeller.

Carrying a spare propeller, propeller nuts, and cotter pins are common practice. If the propeller is damaged and no spare propeller is available, consult an authorized Honda Marine dealer (Refer to page 100 for propeller change information)

Cotter Pin

Check the cotter pin for damage and correct installation. If the cotter pin needs replacement use only a new genuine Honda stainless steel cotter pin.

4. PRE-OPERATION CHECKS

Steering Friction Adjustment (common)

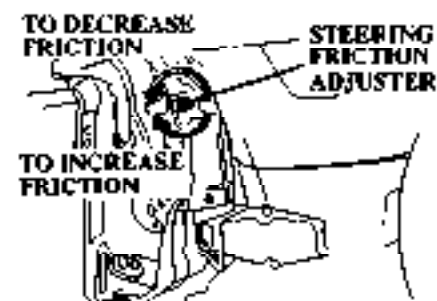

Operate the steering wheel or tiller handle right and left and check for the amount of drag felt.

Adjust the steering friction adjuster so that a slight amount of drag is felt. The steering should move smoothly and freely.

Remote Control Friction Adjustment

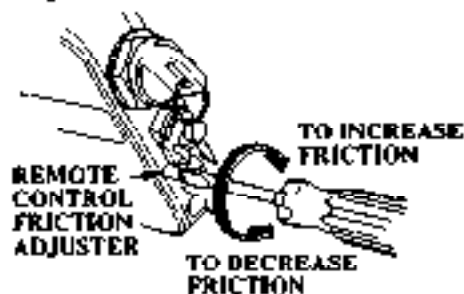

Operate the remote control lever into forward and reverse gears and check for the amount of drag felt.

Adjust the remote control friction adjuster so that a slight amount of drag is felt. The remote control lever should move smoothly and freely.

4. PRE-OPERATION CHECKS

Other Checks

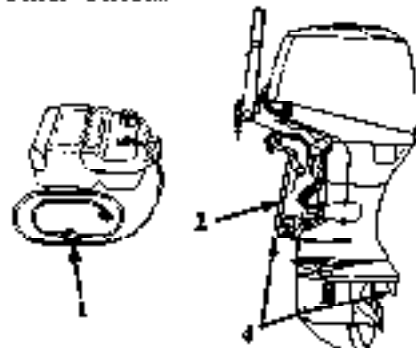

Check the following items:

1. The fuel hose for kinking, collapsing or loose connections.
2. The stern bracket for damage and mounting bolts for proper torque.
3. The tool kit contents. Compare your tool kit contents against the tool kit illustration above. Replace any missing items.
4. The anodes for damage, looseness or excessive corrosion.

The anodes help to protect the outboard motor from corrosion any time they are exposed directly to the water.

3 Tool kit

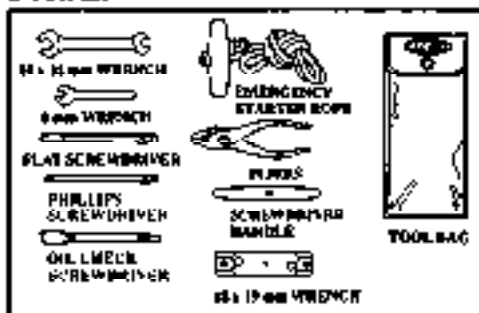

Replace anodes when they are visibly reduced in size or crumble easily.

NOTICE *Painting or coating the anodes will lead to rust and corrosion damage to the outboard motor.*

The following materials should be kept with the boat:

1. Owner's Manual.
2. Tool Kit
3. Spare engine oil, spark plugs, propeller, propeller cotter pins and nut.
4. Required information regarding boating laws and regulations.

5. STARTING THE ENGINE

Fuel Tank and Vent Knob

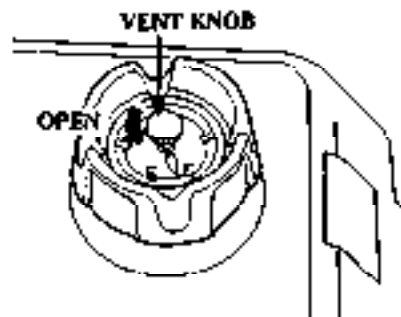

The fuel tank must be properly secured in the boat. This will protect the fuel tank from damage caused by the fuel tank shifting.

The fuel tank must be in a well ventilated area to reduce the chance of a gasoline vapor explosion. Avoid direct sunlight on the fuel tank.

Due to the fuel pump capacity, do not place the fuel tank more than 6 feet away from the motor or lower than 3 feet below the outboard end fuel hose connector.

1. Open the fuel tank vent by turning the vent knob at least 2 or 3 turns counterclockwise. Allow the air pressure inside the fuel tank to equalize with the outside air. With the vent open, air can enter the fuel tank to displace the fuel as the fuel level goes down.
2. Remove the fuel cap and inspect the condition of the fuel cap and gasket. Replace the fuel cap or gasket if they are cracked, damaged or leak fuel.

Fuel Line Connection

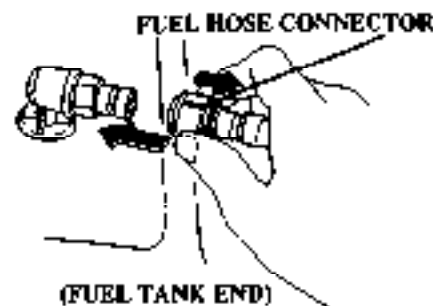

Inspect the fuel hose, and the O-ring seals in the fuel hose connectors. Replace the fuel hose, or fuel hose connectors if they are cracked, damaged or leak fuel. Be sure the fuel hose is not kinked.

1. Connect the fuel hose connector to the fuel tank. Be sure the fuel hose connector is securely snapped in place.

5. STARTING THE ENGINE

FUEL HOSE CONNECTOR

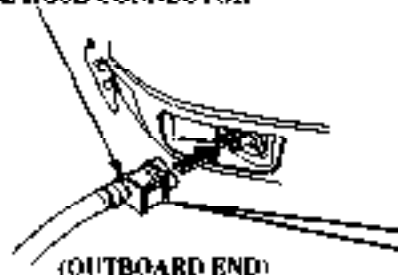

(OUTBOARD END)

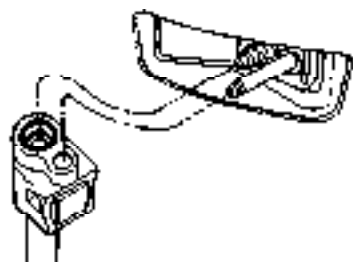

NOTICE *If the outboard end fuel hose connector is forcibly installed in the reversed direction, the fuel hose connector O-ring seal can be damaged. A damaged O-ring seal can cause a fuel leak.*

2. Connect the fuel hose connector to the outboard motor. Install the outboard end fuel hose connector with the clip toward the outside. Be sure the fuel hose connector is securely snapped in place.

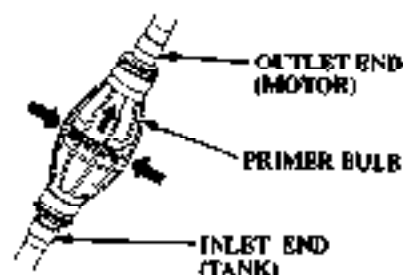

OUTLET END (MOTOR)

PRIMER BULB

INLET END (TANK)

3. Hold the primer bulb so that the outlet end is higher than the inlet end. The arrow on the primer bulb points upward. Squeeze the primer bulb several times until it feels firm, indicating that fuel has reached the carburetors. Check for fuel leaks and repair any leaks before starting the motor.

Do not squeeze the primer bulb when the motor is running because this could cause the carburetors to overflow.

5. STARTING THE ENGINE (TILLER HANDLE TYPE)

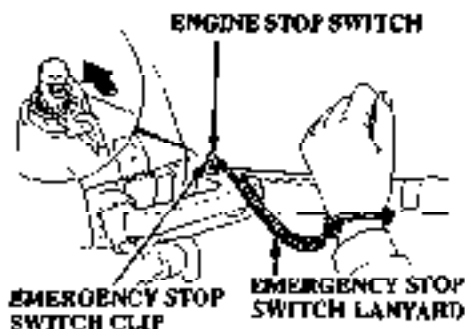

NOTICE The water intakes must be lowered into the water. Running the outboard motor out of the water will damage the water pump and overheat the engine.

1. Engage the emergency stop switch clip located at one end of the emergency stop switch lanyard with the engine stop switch. Attach the other end of the emergency stop switch lanyard securely to the operator.

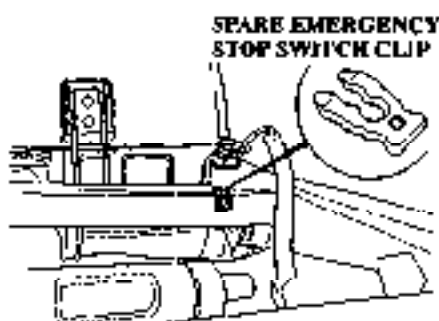

A spare emergency stop switch clip is provided near the engine stop switch.

WARNING If the operator does not attach the emergency stop switch lanyard, and is thrown from his seat or out of the boat, the out-of-control boat can seriously injure the operator, passengers, or bystanders. Always properly attach the lanyard before starting the motor.

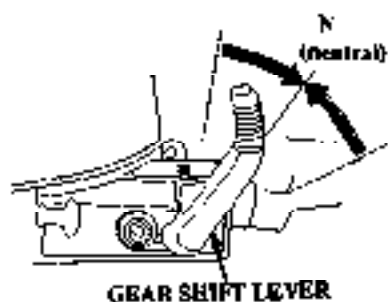

2. Move the gearshift lever to the N (neutral) position.

The engine will not start unless the gearshift lever is in the N (neutral) position.

5. STARTING THE ENGINE (TILLER HANDLE TYPE)

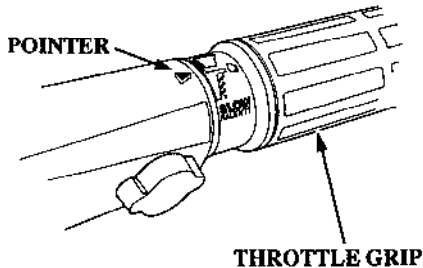

3. Align the engine start symbol "◻" on the throttle grip with the pointer "▶" on the tiller handle.

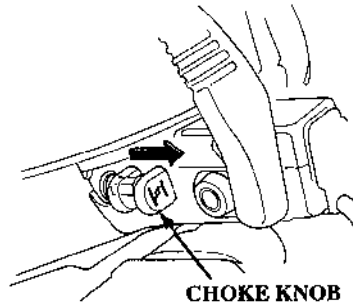

4. When the engine is cold or ambient temperature is low pull the choke knob.
5. Press the start button and start the engine. The starter motor consumes a large amount of current. Do not run it continuously for more than 5 seconds at a time. If the engine does not start within 5 seconds wait at least 10 seconds before using the starter motor again.

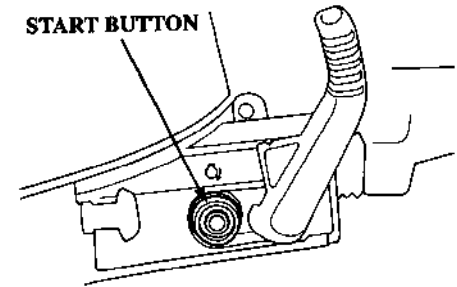

NOTICE Do not press the start button while the engine is running. This can damage the starter motor and flywheel.

5. STARTING THE ENGINE (TILLER HANDLE TYPE)

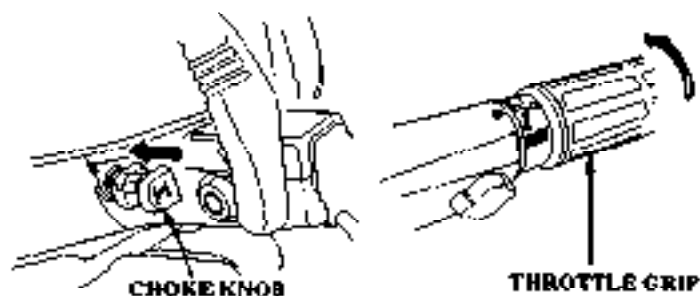

6. If it was necessary to use the choke knob to start the engine, slowly return it to its initial position. Turn the throttle grip in the SLOW direction to a position where the engine does not stall.

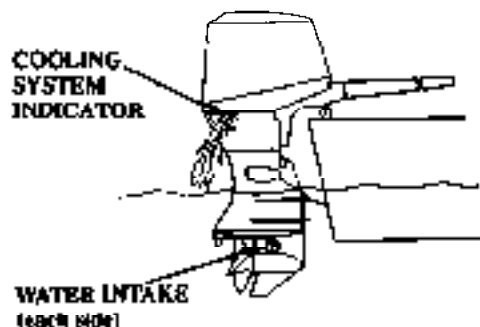

7. After the engine starts, verify water is flowing through the cooling system by monitoring the cooling system indicator. The amount of water coming out of the cooling system indicator will vary due to thermostat operation. Stop the engine if water does not come out of the cooling system indicator or if you see steam. Check the water intake screens and the cooling system indicator discharge port and if necessary remove any obstructions. If the problem continues, contact your closest authorized Honda Marine dealer.

NOTICE Running the outboard motor with an obstruction in the cooling system can damage the water pump and overheat the engine.

5. STARTING THE ENGINE (TILLER HANDLE TYPE)



NORMAL: GREEN LIGHT ON
ABNORMAL: GREEN LIGHT
BLINKING OR OFF

8. With the engine running, check to see if the green engine oil pressure indicator light turns ON. Stop the engine if the oil pressure indicator light does not turn ON. Check the engine oil level (see page 31). If the oil level is normal and the oil pressure indicator light does not turn ON, contact your closest authorized Honda Marine dealer.

9. Warm up the engine as follows:
Above 41°F (5°C) - run the engine for 2 or 3 minutes.
Below 41°F (5°C) - run the engine for at least 5 minutes at approximately 2,000 rpm.
Failure to completely warm up the engine will result in poor engine performance.

5. STARTING THE ENGINE (REMOTE CONTROL TYPE)

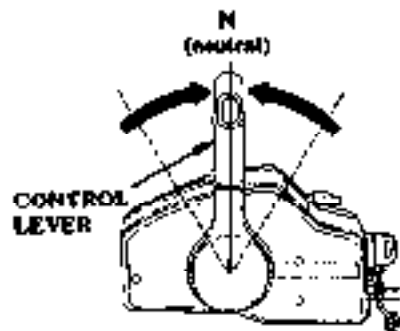
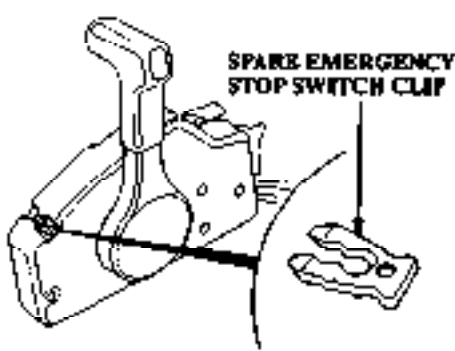
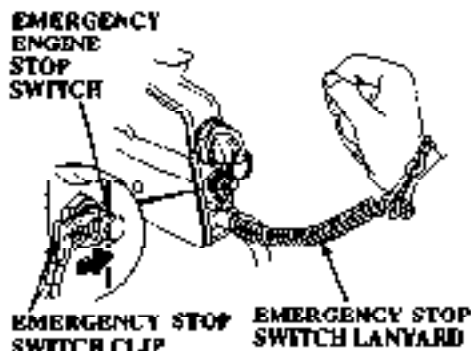

NOTICE The water intakes must be lowered into the water. Running the outboard motor out of the water will damage the water pump and overheat the engine.

1. Engage the emergency stop switch clip located at one end of the emergency stop switch lanyard with the emergency engine stop switch. Attach the other end of the emergency stop switch lanyard securely to the operator.

WARNING If the operator does not attach the emergency stop switch lanyard, and is thrown from his seat or out of the boat, the out-of-control boat can seriously injure the operator, passengers, or bystanders. Always properly attach the lanyard before starting the motor.

The engine will not start unless the emergency stop switch clip is engaged with the emergency engine stop switch.

A spare emergency stop switch clip is provided on the remote control box.

2. Move the control lever to the N (neutral) position.

The engine will not start unless the control lever is in the N (neutral) position.

5. STARTING THE ENGINE (REMOTE CONTROL TYPE)

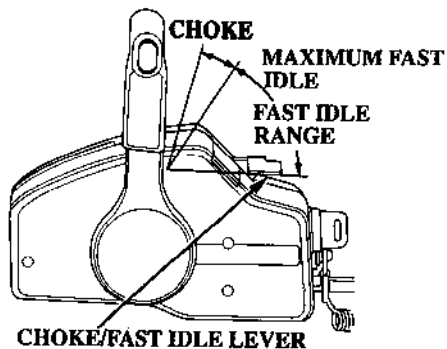

3. When the engine is cold or the ambient temperature is low, lift the choke/fast idle lever up fully. This will provide a rich fuel mixture.

When the engine is warm, it may be necessary to raise the choke/fast idle lever slightly. Hold it in this position.

The choke/fast idle lever will not move unless the control lever is in the N (neutral) position.

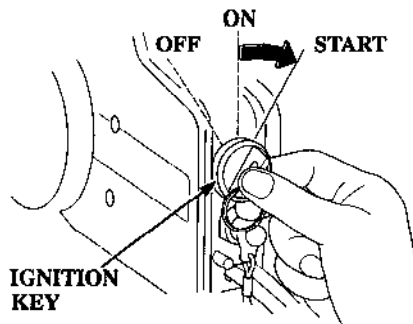

4. Holding the choke/fast idle lever in position, turn the ignition key to the START position and release the key when the engine starts. The starter motor consumes a large amount of current. Do not run it continuously for more than 5 seconds at a time. If the engine does not start within 5 seconds wait at least 10 seconds before using the starter motor again.

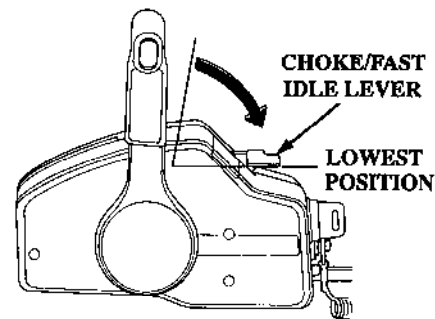

NOTICE Do not turn the ignition key to the start position while the engine is running. This can damage the starter motor and flywheel.

5. After starting the engine, return the lever slowly to the position where the engine does not stall and hold the lever in this position.

The control lever will not move unless the choke/fast idle lever is returned to the lowest position.

5. STARTING THE ENGINE (REMOTE CONTROL TYPE)

COOLING SYSTEM
INDICATOR



WATER INTAKE
(each side)

6. After the engine starts, verify water is flowing through the cooling system by monitoring the cooling system indicator. The amount of water coming out of the cooling system indicator will vary due to thermostat operation. Stop the engine if water does not come out of the cooling system indicator or if you see steam. Check the water intake screens and the cooling system indicator discharge port and if necessary remove any obstructions. If the problem continues, contact your closest authorized Honda Marine dealer.

NOTICE *Running the outboard motor with an obstruction in the cooling system can damage the water pump and overheat the engine.*

OIL PRESSURE
INDICATOR LIGHT

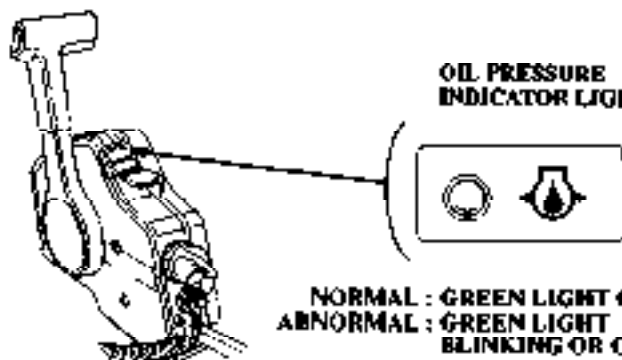

NORMAL : GREEN LIGHT ON
ABNORMAL : GREEN LIGHT
BLINKING OR OFF

7. With the engine running, check to see if the green engine oil pressure indicator light turns ON. Stop the engine if the oil pressure indicator light does not turn ON. Check the engine oil level (see page 31). If the oil level is normal and the oil pressure indicator light does not turn ON, contact your closest authorized Honda Marine dealer.
8. Warm up the engine as follows:
Above 41°F (5°C) - run the engine for 2 or 3 minutes.
Below 41°F (5°C) - run the engine for at least 5 minutes at approximately 2,000 rpm.
Failure to completely warm up the engine will result in poor engine performance.

5. STARTING THE ENGINE (EMERGENCY STARTING)

Emergency Starting

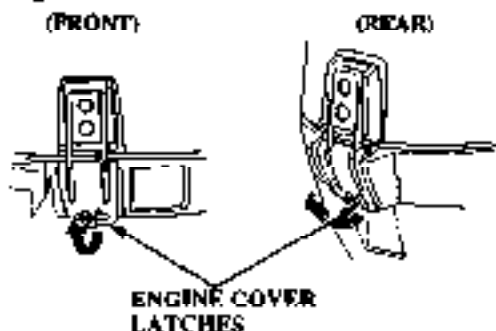

If the electric starting system will not start the engine the engine can be started by using the pull emergency rope from the tool kit.

1. Release the front and rear engine cover latches then remove the engine cover.

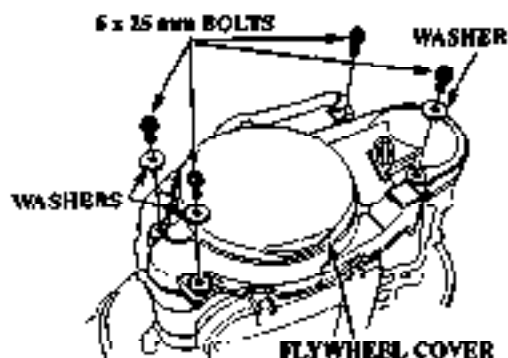

2. Remove the four 6 x 25 mm bolts and the three washers then remove the flywheel cover.

Do not lose the washers.

5. STARTING THE ENGINE (EMERGENCY STARTING)

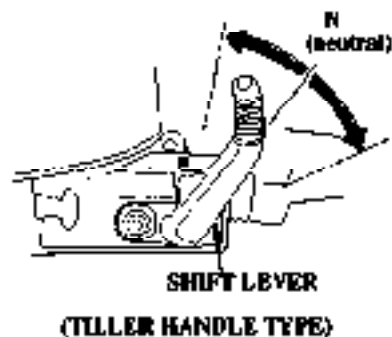

3. Depending on what type of outboard motor you have, move the shift lever or the control lever to the N (neutral) position.

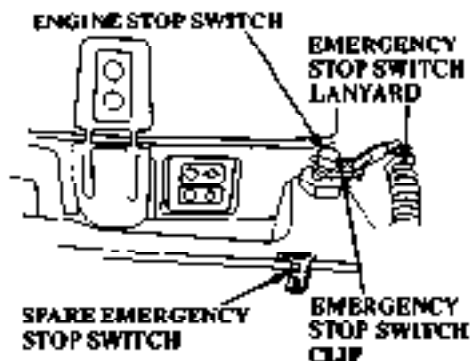
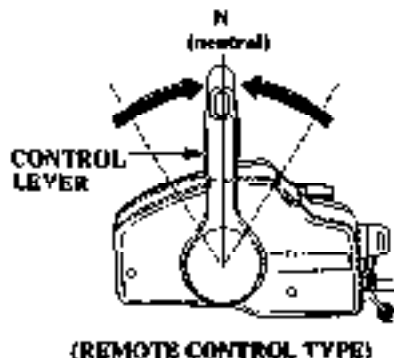

4. If your outboard motor is a tiller handle type, engage the emergency stop switch clip, located at one end of the emergency stop switch lanyard, with the engine stop switch.

A spare emergency stop switch clip is provided near the engine stop switch.

5. STARTING THE ENGINE (EMERGENCY STARTING)

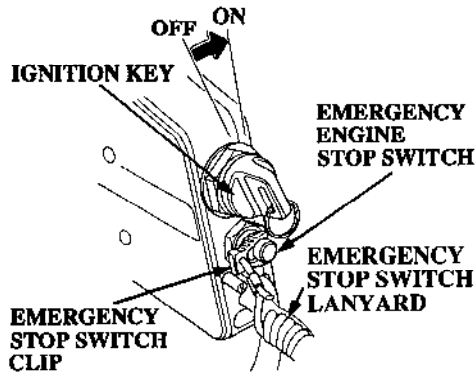

5. If your outboard motor is a remote control type, turn the ignition key to the ON position. Engage the emergency stop switch clip, located at one end of the emergency stop switch lanyard, with the emergency engine stop switch.

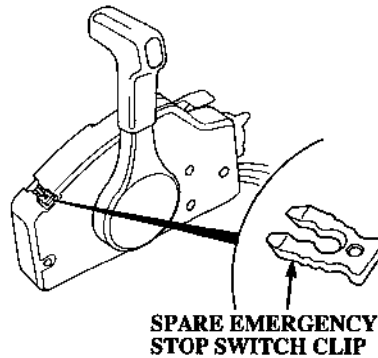

A spare emergency stop switch clip is provided on the remote control box.

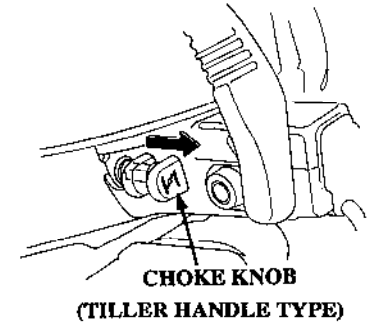

6. If the engine is cold or the ambient temperature is low, pull the manual choke knob located on the front of the outboard motor.

5. STARTING THE ENGINE (EMERGENCY STARTING)

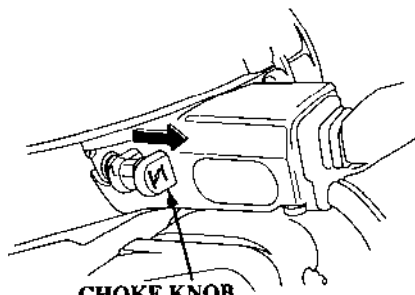

(REMOTE CONTROL TYPE)

It should only be necessary to pull the engine 1 or 2 times with the choke knob out.

ENGINE START SYMBOL

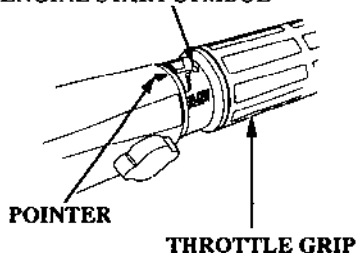

(TILLER HANDLE TYPE)

7. On the tiller handle type align the engine start symbol "△" on the throttle grip with the pointer "▶" on the tiller handle. On the remote control type lift the choke/fast idle lever. The choke/fast idle lever will stay up in the fast idle position.

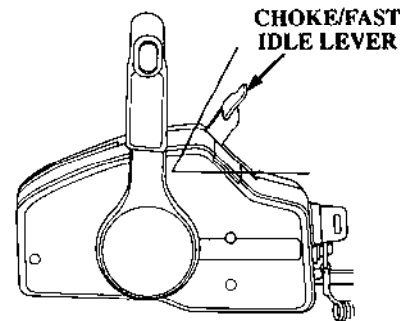

(REMOTE CONTROL TYPE)

5. STARTING THE ENGINE (EMERGENCY STARTING)

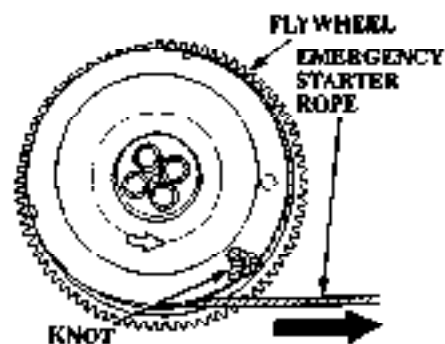

8. Set the emergency starter rope knot in the notch in the flywheel and wind the emergency starter rope counterclockwise around the flywheel.

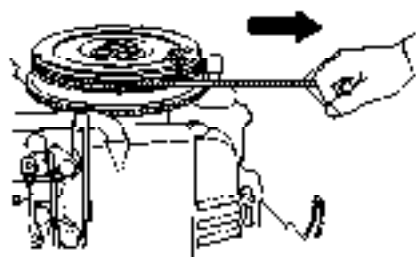

9. Pull the emergency starter rope lightly until resistance is felt, then pull briskly.

If the engine fails to start refer to Troubleshooting on page 103.

10. If it was necessary to use the manual choke knob to start the engine, slowly return it to its initial position.
11. Slowly return the throttle grip to the SLOW position or the choke/fast idle lever to the lowest position to where the engine does not stall.

WARNING: Exposed moving parts can cause injury. Use extreme care when installing the engine cover. Do not operate the outboard motor without the engine cover.

12. Leave the flywheel cover off and install the engine cover. Lock the engine cover latches. Attach the emergency stop switch lanyard securely to the operator and return to the closest boat landing. Contact your closest authorized Honda Marine dealer and have the outboard motor and the electrical system checked.

5. STARTING THE ENGINE

Troubleshooting Starting Problems

SYMPTOM	POSSIBLE CAUSE	REMEDY
Starter motor doesn't turn over.	<ol style="list-style-type: none">1. Shift lever not in neutral position.2. Blown fuse.3. Weak battery.	<ol style="list-style-type: none">1. Set shift lever in neutral position.2. Replace fuse. (refer to page 99)3. Start by using starter rope. (refer to page 47)
Starter motor turns over but engine will not start.	<ol style="list-style-type: none">1. Emergency stop switch clip is not engaged.2. Out of fuel.3. Vent knob not open.4. Primer bulb has not been squeezed.5. Engine flooded.	<ol style="list-style-type: none">1. Engage the emergency stop switch clip. (refer to page 15 and 19)2. Supply fuel. (refer to page 32)3. Open vent knob. (refer to page 38)4. Squeeze primer bulb to supply fuel. (refer to page 39)5. Clean and dry spark plug (refer to page 93)

Break-in Procedure

Break-in period 10 hours.

Break-in operation allows the moving parts to wear-in evenly and thus ensures proper performance and longer outboard motor life.

Break-in your new outboard motor as follows:

First 15 minutes:

Run the outboard motor at trolling speed. Use the minimum amount of throttle opening necessary to operate the boat at a safe trolling speed.

Next 45 minutes:

Run the outboard motor up to a maximum of 2,000 to 3,000 rpm or 10% to 30% throttle opening.

Next 60 minutes:

Run the outboard motor up to maximum of 4,000 to 5,000 rpm or 50% to 80% throttle opening. Short bursts of full throttle are acceptable but do not operate the motor continuously at full throttle.

Next 8 hours:

Avoid continuous full throttle operation (100% throttle opening). Do not run the outboard motor at full throttle for more than 5 minutes at a time.

For boats that plane easily, bring the boat up on plane then reduce the throttle opening to the specified break-in settings called out above.

6. OPERATION (TILLER HANDLE TYPE)

Gear Shifting

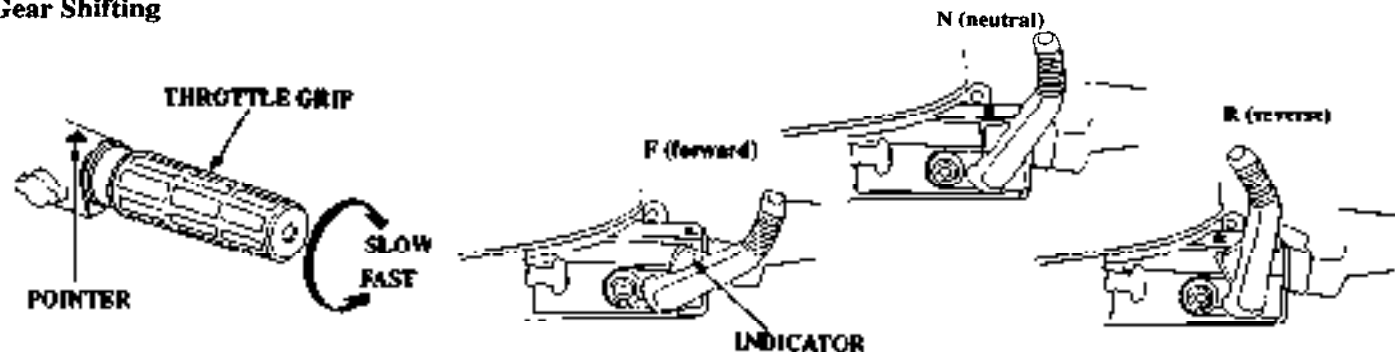

Gearshift lever has 3 positions: **FORWARD**, **NEUTRAL**, and **REVERSE**.

An indicator at the base of the gearshift lever aligns with the letters **F**, **N**, and **R** on the motor pan.

1. Align the pointer on the tiller handle with the **SLOW** position on the throttle grip to decrease engine speed.

The throttle mechanism is designed to limit the throttle grip travel when operating in the **REVERSE** or **NEUTRAL** positions. The throttle grip can only be turned to the **FAST** position when operating in forward gear.

2. On the Gas assisted type, put the tilt lever in the **LOCK** position to prevent the outboard motor from tilting up, when operating in reverse (refer to page 25).
3. Move the gearshift lever to engage the desired gear.

6. OPERATION (TILLER HANDLE TYPE)

Steering

RIGHT TURN



Move the tiller handle to the left.

LEFT TURN



Move the tiller handle to the right.

The tiller handle is moved in the opposite direction in which you want the boat to turn.

Cruising

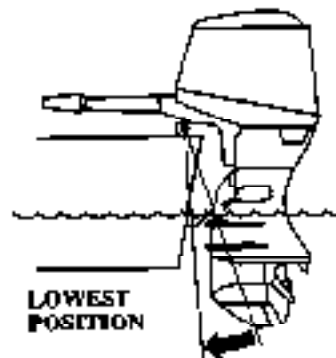

On the Power trim/tilt type, press the DN portion of the power trim/tilt switch (optional part) and tilt the motor to the lowest position.

A power trim/tilt foot switch is available from your authorized Honda dealer.

6. OPERATION (TILLER HANDLE TYPE)

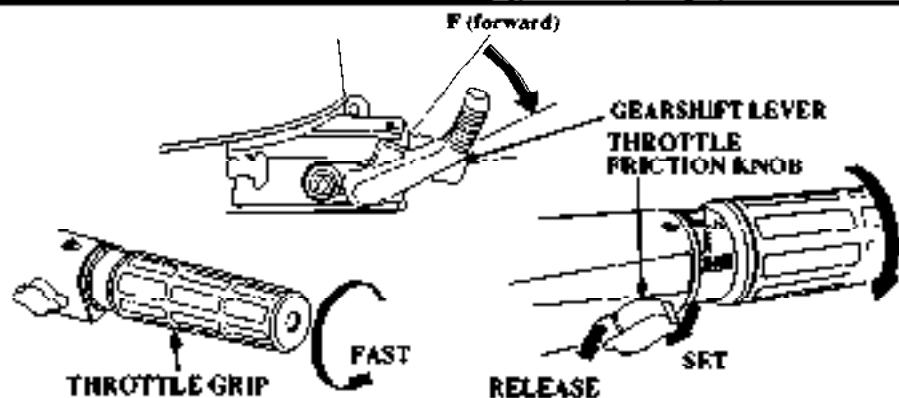

With the gearshift lever in the F (forward) position, turn the throttle grip toward the FAST mark to increase speed. For optimum fuel economy, limit throttle opening to $\frac{2}{3}$.

To set the throttle at a steady speed, turn the throttle friction knob clockwise. To release the throttle grip for manual speed control, turn the friction knob counterclockwise.

6. OPERATION (REMOTE CONTROL TYPE)

Gear Shifting

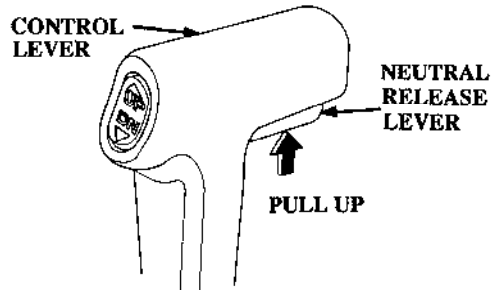

While pulling up the neutral release lever, move the control lever 30° toward F (forward) or 30° toward R (reverse) to engage the desired gear.

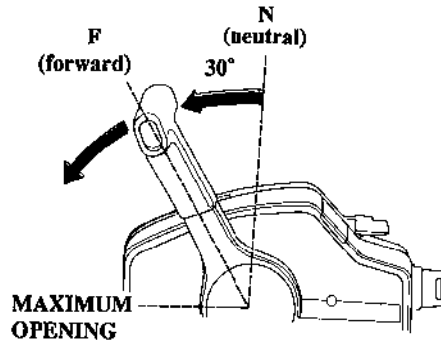

Moving the control lever further from 30° will increase throttle opening and boat speed.

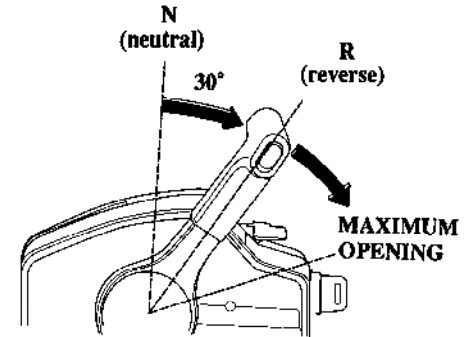

The control lever will not move unless the neutral release lever is pulled up and choke/fast idle lever is in the lowest position.

6. OPERATION (REMOTE CONTROL TYPE)

Cruising

POWER TRIM/TILT SWITCH

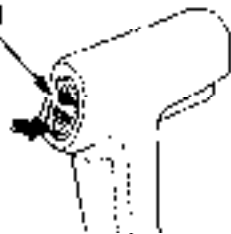

1. On the Power trim/tilt type, press the DN portion of the power trim/tilt switch and tilt the motor to the lowest position.

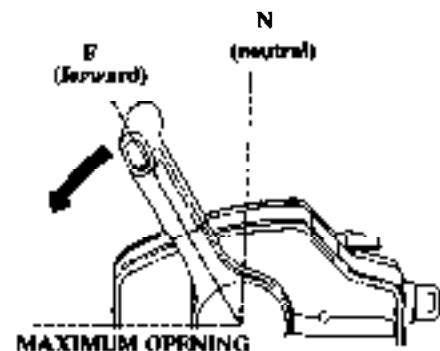
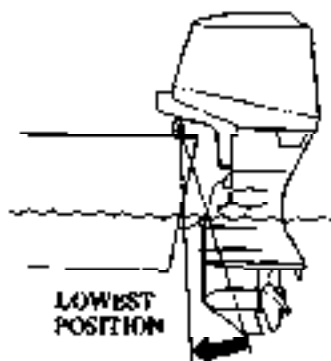

2. Move the control lever from N (neutral) 30° toward F (forward) to engage the F (forward) gear. Moving the control lever further from 30° will increase the throttle opening and boat speed.
3. For optimum fuel economy, limit throttle opening to 2/3.

6. OPERATION (GAS ASSISTED TILT TYPE)

Tilt Lever

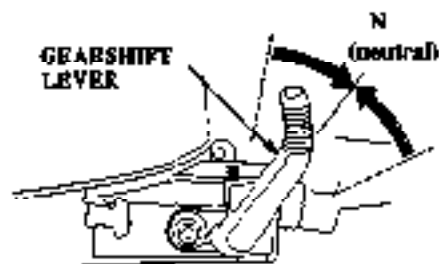

Tilt the motor up to prevent the propeller and gear case from hitting the bottom when beaching or stopping in shallow water.

1. Move the gearshift lever to the N (neutral) position and stop the engine.

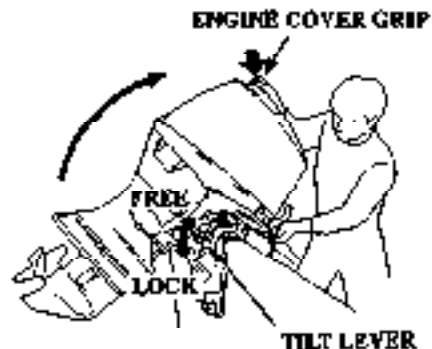
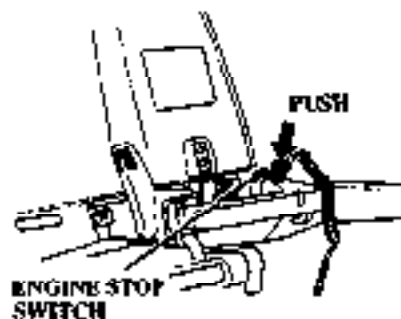

2. To tilt the motor up, move the tilt lever to the FREE position, then pull the engine cover grip and raise the motor. Do not push down on the tiller handle.

6. OPERATION (GAS ASSISTED TILT TYPE)

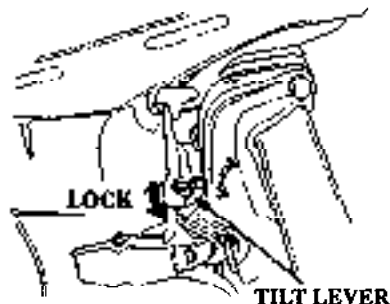

3. With the outboard motor tilted up to the desired position, move the tilt lever to the LOCK position to lock the motor.

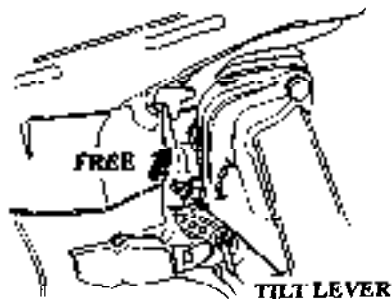

4. To lower the motor back down, move the tilt lever to the FREE position, while holding the engine cover grip, then lower the motor gently. Move the tilt lever to LOCK position.

The tilt lever must be in the LOCK position before operating the motor or the motor could tilt up when operating in reverse.

6. OPERATION (GAS ASSISTED TILT TYPE)

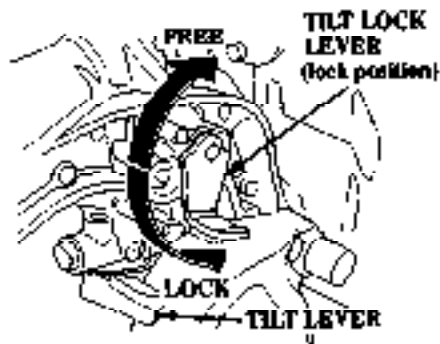

Use the tilt lock lever to hold the motor in the highest tilt position when the boat is moored for a long time.

1. Move the tilt lever to the FREE position (refer to page 60), then pull the engine cover grip and tilt the motor all the way up.
2. Move the tilt lock lever to the LOCK position and lower the outboard motor slowly.

3. Move the tilt lever to the LOCK position.
4. To lower the motor, move the tilt lever to the FREE position. Lift up on the engine cover grip and swing the tilt lock lever to the FREE position.
5. Lower the engine gently. Move the tilt lever to the LOCK position.

6. OPERATION (POWER TRIM/TILT TYPE)

XRTA type outboard (refer to page 23)

The power trim/tilt system can adjust the motor angle while cruising, or the motor tilt angle while mooring. Motor trim angle adjustment is necessary to compensate for boat load or weight distribution, water conditions, propeller or engine condition. The motor trim angle can be adjusted while accelerating or cruising to obtain the maximum boat speed, optimum boat stability, and fuel economy. Under normal conditions, the boat will achieve optimum boat performance when the motor is running at maximum rpm and the ventilation plate is level with the water.

Press either the UP or DN portion of the power trim/tilt switch and trim the motor to the best position for the cruising conditions.

The power trim/tilt system operates when the switch is pressed, and it stops when the switch is released.

POWER TRIM/TILT SWITCH
(remote control type)

Press UP to raise
bow.

Press DN to lower
bow.

CONTROL LEVER

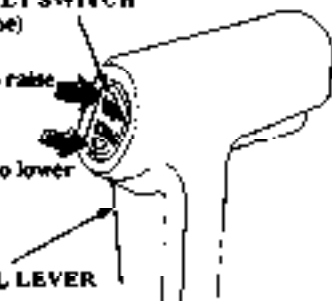

On the tiller handle type, the power trim/tilt switch is the optional part. The power trim/tilt switch is available on your authorized Honda Marine dealer.

NOTICE Excessive trim/tilt angle during operation can cause the propeller to raise out of the water and cause propeller ventilation and engine over-revving. Excessive trim/tilt angle can also damage the water pump and overheat the engine.

To trim motor up slightly, press the UP portion momentarily.
To trim motor down slightly, press the DN portion momentarily.

6. OPERATION (POWER TRIM/TILT TYPE)

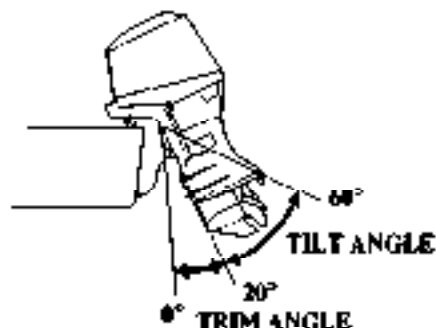

Decrease the trim angle on high speed turns to reduce the possibility of propeller ventilation.

Improper motor trim angle can result in an unstable steering condition. The power trim/tilt warning system will be activated and an intermittent buzzer sounds when the motor is trimmed excessively. (refer to page 70).

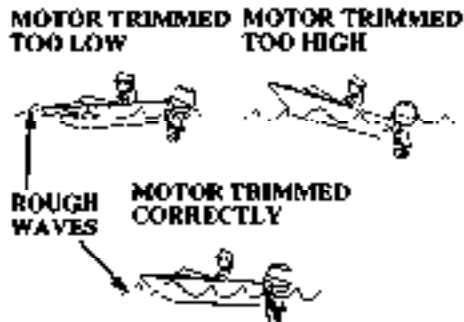

When cruising:

- (A) Into a high wind, trim the motor down slightly to level the bow and improve boat stability.
- (B) With a tail wind, trim the motor up slightly to raise the bow and improve boat stability.
- (C) Through rough waves, do not trim the motor too low or too high to avoid an unstable steering condition.

6. OPERATION (POWER TRIM/TILT TYPE)

Trim Meter

The trim meter indicates the trim angle of the motor. Refer to the trim meter, and press the UP or DN portion of the power trim/tilt switch to adjust the motor trim angle to achieve boat performance and stability.

- BOW TOO LOW DUE TO**
1. LOAD IN THE FRONT
2. MOTOR TRIMMED TOO LOW



- BOW TOO HIGH DUE TO**
1. LOAD IN THE REAR
2. MOTOR TRIMMED TOO HIGH



With the motor trimmed low the trim meter will read as shown. To raise the bow increase the motor trim angle by pressing the UP portion of the power trim/tilt switch.

With the motor trimmed high the trim meter will read as shown. To lower the bow decrease the motor trim angle by pressing the DN portion of the power trim/tilt switch.

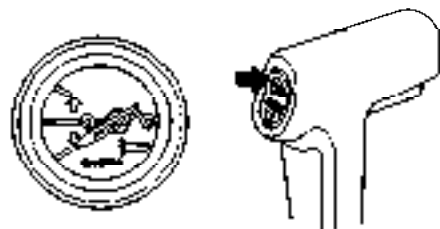

6. OPERATION (POWER TRIM/TILT TYPE)

Power Tilt Switch (Motor Pan)



POWER TILT SWITCH

The power tilt switch located on the motor pan is a convenience switch for tilting the motor for trailering, or performing outboard motor maintenance. This power tilt switch should only be operated when the boat is stopped and the motor is off.

Manual Relief Valve

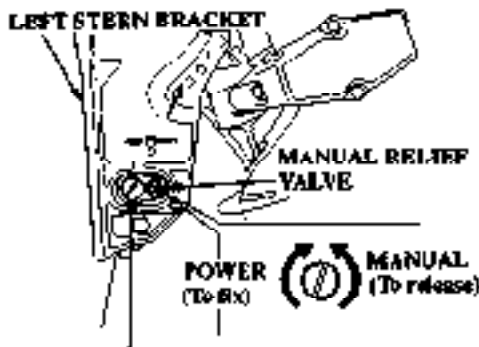

Do not turn this screw. If this screw is turned hydraulic oil will bleed out of the power trim/tilt system. Should this happen it will be necessary to contact your closest authorized Honda Marine dealer and have the system refilled.

If the power trim/tilt switch will not tilt the outboard motor, the motor can be manually tilted up or down by operating the manual relief valve. To tilt the outboard motor manually, turn the manual relief valve under the left stern bracket no more than 1 or 2 turns counterclockwise using a screw driver. After tilting the motor, turn the manual relief valve clockwise securely. The manual relief valve must be tightened securely before operating the motor or the motor could tilt up when operating in reverse.

6. OPERATION (POWER TRIM/TILT TYPE)

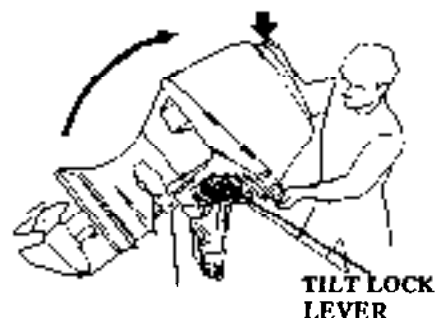

Tilt Lock Lever

Use the tilt lock lever when the boat is moored.

1. Tilt the motor up as far as it will go using the power trim/tilt switch.
2. Move the tilt lock lever to the LOCK position and lower the outboard motor until the lock lever contacts the stem bracket (refer to page 25).

It may be necessary to lift the engine cover grip slightly to swing the tilt lock lever into the LOCK position.

3. To lower the motor, tilt the motor up slightly, move the tilt lock lever to the FREE position, and lower the motor to the desired position.

Trim Tab Adjustment

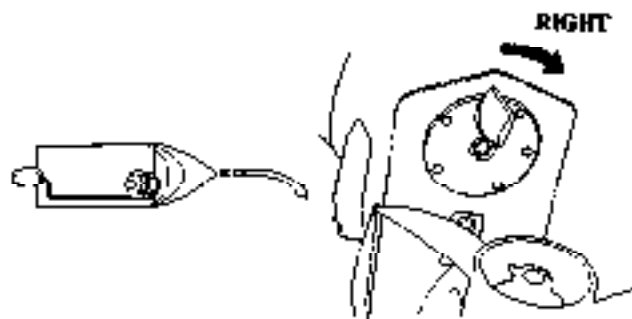
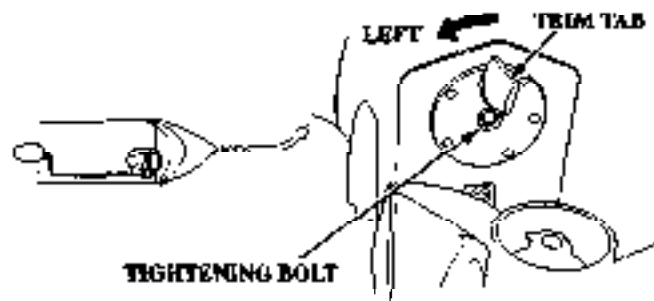

The trim tab is provided to adjust for "torque steer" which is a reaction of the propeller rotation or propeller torque. If during a high speed turn an unequal amount of effort is required to turn the boat right or left, adjust the trim tab so that an equal amount of effort is required.

Distribute the load evenly in the boat and run the boat in a straight course at full throttle. Slightly turn the steering wheel or tiller handle for both right and left turns to determine the amount of effort required.

If less effort is required to make left turns:

Loosen the trim tab tightening bolt and turn the rear end of the trim tab toward the left. Tighten the bolt securely.

If less effort is required to make right turns:

Loosen the trim tab tightening bolt and turn the rear end of the trim tab toward the right. Tighten the bolt securely.

Make small adjustments at a time and retest. Incorrect trim tab adjustment can cause adverse steering.

The trim tab also functions as a sacrificial anode.

NOTICE Painting or coating the anode will lead to rust and corrosion damage to the outboard motor.

6. OPERATION (MOTOR PROTECTION SYSTEM)

Engine Oil Pressure and Overheat Warning System

If the engine oil pressure drops and/or the engine overheats, either or both warning systems could be activated. When activated the engine speed will decrease gradually and the green oil pressure indicator light will turn OFF and the red overheat indicator light will turn ON. A continuous buzzer will sound on the remote control type. The engine speed can not be increased with a larger throttle opening until the malfunction is corrected. When the malfunction is corrected the engine speed will increase gradually.

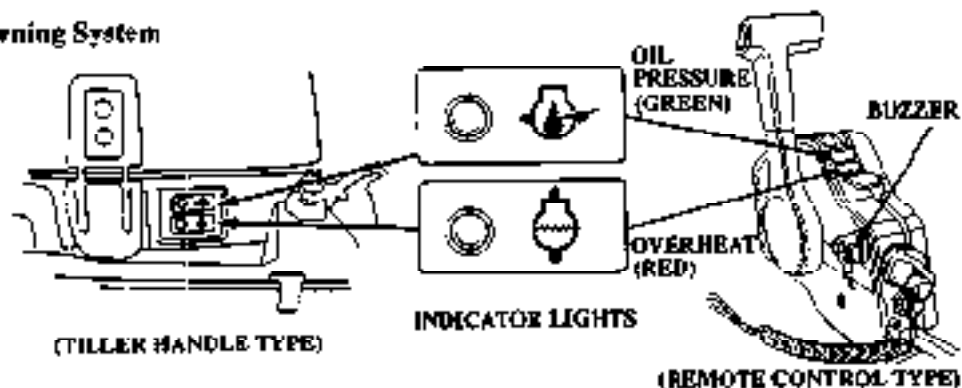

System		Indicator light		Buzzer
		Oil pressure	Overheat	Remote control type
Normal		ON	OFF	—
Abnormal	Low oil pressure	OFF	OFF	Continuous
	Overheat	ON	ON	Continuous
	Low oil pressure/overheat	OFF	ON	Continuous

6. OPERATION (MOTOR PROTECTION SYSTEM)

When the oil pressure warning system is activated:

1. Stop the engine immediately and check the engine oil level (refer to page 31)
2. If the oil is up to the recommended level, restart the engine. If the oil pressure warning system stops after 30 seconds, the system is normal.

If the throttle was closed suddenly after cruising at full throttle, the engine speed may drop below the specified idle speed. This could cause the oil pressure warning system to activate momentarily.

3. If the oil pressure warning system stays activated after 30 seconds, return to the closest boat landing and contact your closest authorized Honda Marine dealer.



COOLING SYSTEM INDICATOR

When the overheat warning system is activated:

1. Return the gearshift lever or control lever to the N (neutral) position immediately. Check to see if water is flowing out of the cooling system indicator.
2. If water is flowing out of the cooling system indicator, continue idling for 30 seconds. If the overheat warning system stops after 30 seconds the system is normal.

If the motor is turned off after running at full throttle, the engine temperature may rise above normal. If the motor is restarted, shortly after being turned off, the overheat warning system could be activated momentarily.

3. If the overheat warning system stays activated, stop the engine. Lift up the motor and check the water intakes for obstructions. If there are no obstructions at the water intakes, return to the closest boat landing and contact your closest authorized Honda Marine dealer.

6. OPERATION (MOTOR PROTECTION SYSTEM)

Over-Rev Limiter

This outboard motor is equipped with an engine over-rev limiter which activates when the engine speed increases excessively. The over-rev limiter can be activated while cruising, tilting up the motor, or when ventilation occurs during a sharp turn.

When the over-rev limiter is activated:

1. Reduce the throttle opening immediately and check the trim angle.
2. If the trim angle is correct but the over-rev limiter stays activated, stop the engine and check the condition of the outboard motor and check the propeller for damage. Correct or service as necessary.

Power Trim Warning System

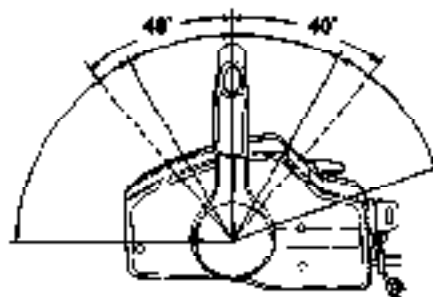

If the motor trim angle is more than 20° and the control lever is moved more than 40° forward/aftward from the N (neutral) position, an intermittent buzzer will sound and beep at one second intervals.

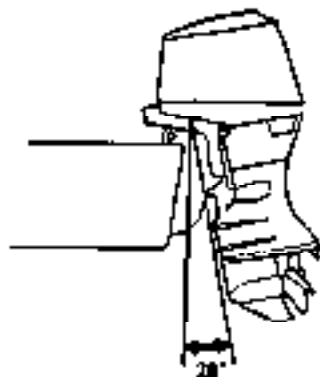

6. OPERATION (MOTOR PROTECTION SYSTEM)



When the power trim warning system is activated:

1. Immediately decrease the trim angle by pressing the DN portion of the power trim/tilt switch.
2. Immediately reduce the throttle opening to SLOW and operate the engine at low speed.

Anodes

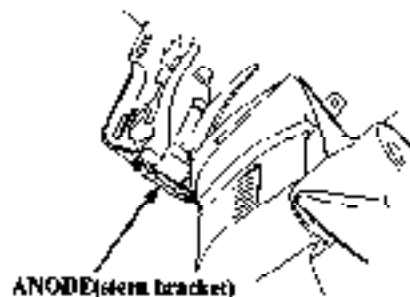
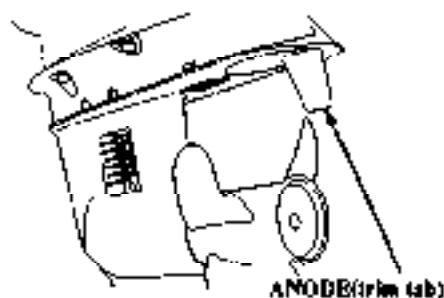

The anodes are a sacrificial material which helps to protect the outboard motor from corrosion.

NOTICE *Painting or coating the anodes will lead to rust and corrosion damage to the outboard motor*

There are also 2 small sacrificial anodes in the water passages of the engine block.

6. OPERATION

Shallow Water Operation

NOTICE Excessive trim/tilt angle during operation can cause the propeller to raise out of the water and cause propeller ventilation and engine over-revving. Excessive trim/tilt angle can also damage the water pump and overheat the engine. Water pump failure due to propeller ventilation is not covered under the Distributor's Limited Warranty.

When operating in shallow water, tilt the motor up to prevent the propeller and gear case from hitting the bottom (refer to pages 59 and 62). With the motor tilted up, operate the motor at low speed.

Monitor the cooling system indicator for water discharge. Be sure that the motor is not tilted so high that the water intakes are out of the water.

If an excessive amount of throttle is used when operating in forward gear, the motor will return to the transom angle adjusting rod.
(Gas assisted tilt type).

If the motor trim angle is more than 20° and the control lever is moved more than 40° forward/rearward from the N (neutral) position, the power trim warning system will be activated (refer to page 70).
(Power trim/tilt type).

High Altitude Operation

At high altitude, the standard carburetor air-fuel mixture will be too rich. Performance will decrease, and fuel consumption will increase. A very rich mixture will also foul the spark plugs and cause hard starting.

High altitude performance can be improved by specific modifications to the carburetors. If you always operate your outboard at altitudes above 5,000 feet (1,500 meters) have an authorized Honda Marine dealer perform this carburetor modification.

Even with carburetor modification, engine horsepower will decrease about 3.5% for each 1,000 foot (300 meter) increase in altitude. The effect of altitude on horsepower will be greater than this if no carburetor modification is made.

NOTICE *When the carburetors have been modified for high altitude operation, the air-fuel mixture will be too lean for low altitude use. Operation at altitudes below 5,000 feet (1,500 meters) with modified carburetors may cause the engine to overheat and result in serious engine damage. For use at low altitudes, have an authorized Honda Marine dealer return the carburetors to original factory specifications.*

7. STOPPING THE ENGINE (TILLER HANDLE TYPE)

Emergency Engine Stop

ENGINE STOP SWITCH



Disengage the emergency stop switch clip from the engine stop switch by pulling the emergency stop switch lanyard.

It is a good idea to stop the engine with the emergency stop switch lanyard from time to time to be sure that the switch is operating properly.

Normal Engine Stop



1. Turn the throttle grip to SLOW position and move the gearshift lever to N(neutral).



7. STOPPING THE ENGINE (TILLER HANDLE TYPE)

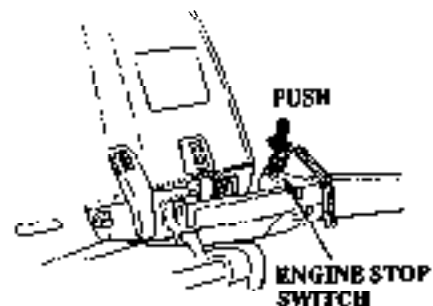

2. Push the engine stop switch until the engine stops.

7. STOPPING THE ENGINE (REMOTE CONTROL TYPE)

Emergency Engine Stop

EMERGENCY
STOP SWITCH

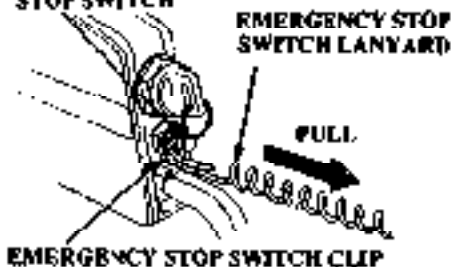

Disengage the emergency stop switch clip from the emergency engine stop switch by pulling the emergency stop switch lanyard

It is a good idea to stop the engine with the emergency stop switch lanyard from time to time to be sure that the switch is operating properly.

Normal Engine Stop

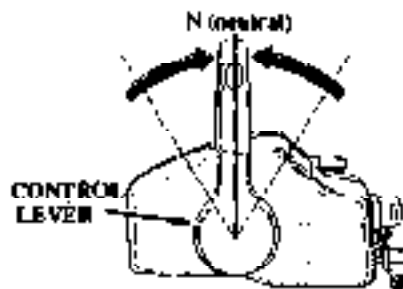

1. Move the control lever to the N (neutral) position and turn the ignition key to the OFF position.



2. When the boat is not in use, remove and store the ignition key.

Trailer

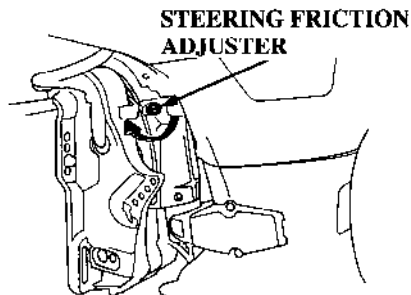

When trailering or transporting the boat with the motor attached, it is recommended that the motor remain in the normal run position. Tighten the steering friction adjuster securely to stop the motor's side to side movement.

If there is insufficient road clearance with the motor in the normal run position, then trailer the motor in the tilted position using a commercially available motor support bar (refer to your motor support bar manufacturer's instructions) or remove the motor from the boat.

Close the fuel cap vent knob (refer to page 29).

Disconnect the fuel coupling from the outboard motor (refer to page 38).

Horizontal Transport

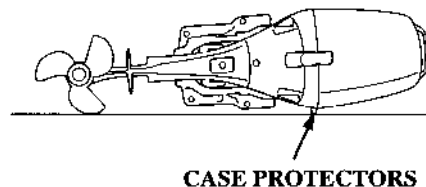

Before removing the motor from the boat, drain the carburetors. Follow the carburetor drain procedure on page 103.

Always rest the motor on the case protectors and be sure to protect it from impact and damage.

9. CLEANING AND FLUSHING



WASH PLUG (flush plug)

Thoroughly clean and flush the outboard motor with fresh water after operating in dirty or salty water.

Flush Kit (optional part)

1. Wash the outside of the outboard motor with clean, fresh water.
2. Remove the wash plug and sealing washer from the WASH plug hole in the gear case. Be sure not to remove the oil level plug from the OIL LEVEL plug hole in the gear case.

FLUSH KIT COUPLER

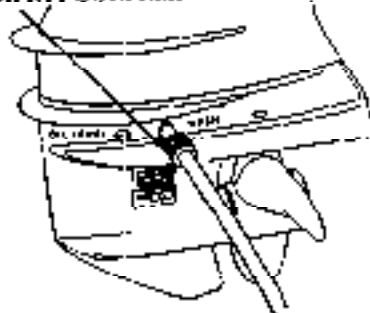

WARNING Keep children and pets away from the area, and stay clear of all moving parts during this procedure.

3. Remove the sealing washer from the wash plug and install the sealing washer on the flush kit coupler.
4. Install the flush kit coupler into the WASH plug hole and connect a fresh water hose to the flush kit coupler.

5. Move the gearshift lever or control lever to the N (neutral) position. Flush the outboard motor in the neutral position only.

6. Turn on the fresh water supply to the flush kit coupler.

NOTICE Running the outboard motor without sufficient cooling water will damage the water pump and over-heat the engine.

9. CLEANING AND FLUSHING

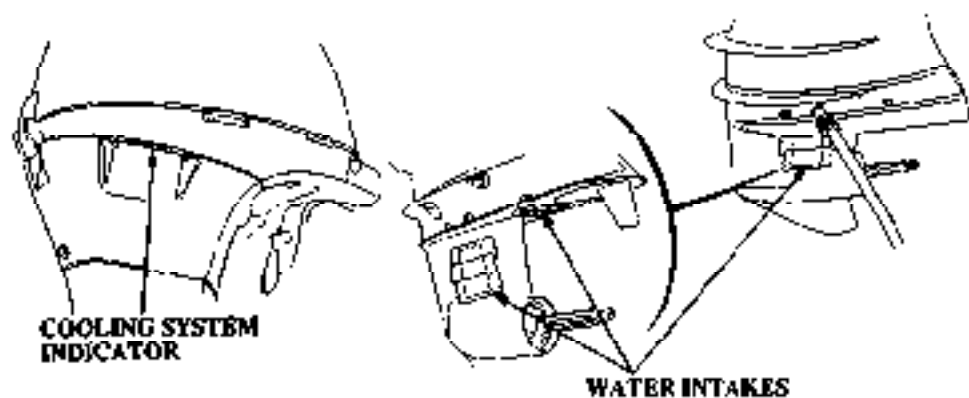

7. Start the engine. Monitor the cooling system indicator. Stop the engine if water does not come out of the cooling system indicator and check the fresh water supply. If the fresh water supply is insufficient it may be necessary to temporarily cover the three water intakes with duct tape.

8. Allow the engine to run at idle for at least 5 minutes to clean the inside of the motor.
9. Stop the motor and remove the flush kit coupler.
10. Remove the sealing washer from the flush kit coupler and install the sealing washer on the wash plug.

If tape was used to cover the three water intakes in step 7, remove the tape now.

11. Install the wash plug into the gear case securely.

10. MAINTENANCE

THE IMPORTANCE OF MAINTENANCE

Good maintenance is essential for safe, economical, and trouble-free operation. It will also help reduce pollution.

WARNING Improper maintenance, or failure to correct a problem before operation, can cause a malfunction in which you can be seriously hurt or killed.

Always follow the inspection and maintenance recommendations and schedules in this owner's manual.

To help you properly care for your outboard motor, the following pages include a maintenance schedule, routine inspection procedures, and simple maintenance procedures using basic

hand tools. Other service tasks that are more difficult, or require special tools, are best handled by professionals and are normally performed by a Honda technician or other qualified mechanic.

The maintenance schedule applies to normal operating conditions. If you operate your outboard motor under unusual conditions, consult your servicing dealer for recommendations applicable to your individual needs and use.

Maintenance, replacement, or repair of the emission control devices and systems may be performed by any marine engine repair establishment or individual, using parts that are "certified" to EPA standards.

MAINTENANCE SAFETY

Some of the most important safety precautions follow. However, we cannot warn you of every conceivable hazard that can arise in performing maintenance. Only you can decide whether or not you should perform a given task.

WARNING Failure to properly follow maintenance instructions and precautions can cause you to be seriously hurt or killed.

Always follow the procedures and precautions in this owner's manual.

Safety Precautions

- **Make sure the engine is off before you begin any maintenance or repairs.** This will eliminate several potential hazards:
 - **Carbon monoxide poisoning from engine exhaust.**
Be sure there is adequate ventilation whenever you operate the engine.
 - **Burns from hot parts.**
Let the engine cool before touching.
 - **Injury from moving parts.**
Do not run the engine unless instructed to do so.
- **Read the instructions before you begin, and make sure you have the tools and skills required.**

- **To reduce the possibility of fire or explosion, be careful when working around gasoline. Use only a nonflammable solvent, not gasoline to clean parts. Keep cigarettes, sparks, and flames away from all fuel-related parts.**

Remember that an authorized Honda Marine dealer knows your outboard motor best and is fully equipped to maintain and repair it.

To ensure the best quality and reliability, use only new, genuine Honda parts or their equivalents for repair and replacement.

EMISSION CONTROL SYSTEM INFORMATION**Source of Emissions**

The combustion process produces carbon monoxide, oxides of nitrogen, and hydrocarbons. Control of hydrocarbons and oxides of nitrogen is very important because, under certain conditions, they react to form photochemical smog when subjected to sunlight.

Honda utilizes lean carburetor settings and other systems to reduce the emissions of oxides of nitrogen and hydrocarbons.

10. MAINTENANCE

The U.S. and California Clean Air Acts

EPA and California regulations require all manufacturers to furnish written instructions describing the operation and maintenance of emission control systems.

The following instructions and procedures must be followed in order to keep the emissions from your Honda engine within the emission standards.

Tampering and Altering

Tampering with or altering the emission control system may increase emissions beyond the legal limit. Among those acts that constitute tampering are:

- Removal or alteration of any part of the intake, fuel, or exhaust systems.

- Alterations that would cause the engine to operate outside its design parameters.

Problems That May Affect Emissions

If you are aware of any of the following symptoms, have your engine inspected and repaired by your servicing dealer.

- Hard starting or stalling after starting.
- Rough idle.
- Misfiring or backfiring under load.
- Afterburning (backfiring).
- Black exhaust smoke or high fuel consumption.

Replacement Parts

The emission control systems on your Honda engine were designed, built, and certified to conform with EPA and California emission regulations. We recommend the use of genuine Honda parts whenever you have maintenance done.

These original-design replacement parts are manufactured to the same standards as the original parts, so you can be confident of their performance.

The use of replacement parts that are not of the original design and quality may impair the effectiveness of your emission control system.

A manufacturer of an aftermarket part assumes the responsibility that the part will not adversely affect emission performance.

The manufacturer or rebuilder of the part must certify that use of the part will not result in a failure of the engine to comply with emission regulations.

Maintenance

Follow the maintenance schedule on page 87. Remember that this schedule is based on the assumption that your machine will be used for its designed purpose. Sustained high-load or high-temperature operation will require more frequent service.

10. MAINTENANCE

STAR LABEL

A Star label was applied to this outboard motor in accordance with the requirements of the California Air Resources Board.

The Star Label means Cleaner Marine Engines

This engine has been certified as a:



The Symbol for Cleaner Marine Engines:

Cleaner Air and Water - for a healthier lifestyle and environment.

Better Fuel Economy - burns up to 30 - 40 percent less gas and oil than conventional carbureted two -stroke engines, saving money and resources.

Longer Emission Warranty - protects consumer for worry free operation.



**One Star
Low Emission**

The one-star label identifies engines that meet the Air Resources Board's 2001 exhaust emission standards.

Engines meeting these standards have 75% lower emissions than conventional carbureted two-stroke engines. These engines are equivalent to the U.S. EPA's 2006 standards for marine engines.



**Two Stars
Very Low Emission**

The two-star label identifies engines that meet the Air Resources Board's 2004 exhaust emission standards.

Engines meeting these standards have 20% lower emissions than One Star - Low-Emission engines.



**Three Stars
Ultra Low Emission**

The three-star label identifies engines that meet the Air Resources Board's 2008 exhaust emission standards.

Engines meeting these standards have 65% lower emissions than One Star - Low-Emission engines.

Cleaner Watercraft - Get the Facts
1-800-END-SMOG
www.arb.ca.gov

10. MAINTENANCE

Tool Kit and Spare Parts

The following tools and spare parts are supplied with the outboard motor for maintenance, adjustment, and emergency repairs.

TOOL KIT

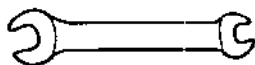

10 x 12 mm WRENCH

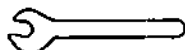

8 mm WRENCH

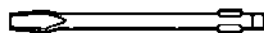

FLAT SCREWDRIVER

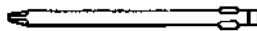

PHILLIPS SCREWDRIVER

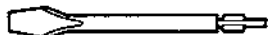

OIL CHECK SCREWDRIVER



EMERGENCY
STARTER ROPE



PLIERS



SCREWDRIVER HANDLE

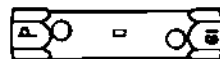

18 x 19 mm
SOCKET
WRENCH



TOOL BAG

MAINTENANCE SCHEDULE

Use only genuine HONDA parts or their equivalent for maintenance or repair.

Replacement parts which are not of equivalent quality may damage the motor.

ITEM	REGULAR SERVICE PERIOD (3)		Each use	First month or 20 hrs.	Every 6 months or 100 hrs.	Every year or 200 hrs.	Every 2 years or 400 hrs.
	Perform as every indicated month or operating hour interval, whichever comes first.						
● Engine oil	Check level		○				
	Change			○	○		
Gear case oil	Check level				○		
	Check for water contamination					○	
	Change			○			
● Engine oil filter	Change					○ (2)	
Timing belt	Check-Adjust					○ (2)	
Carburetor linkage	Check-Adjust			○ (2)	○ (2)		
● Idling speed	Check-Adjust			○ (2)	○ (2)		
● Valve clearance	Check-Adjust			○ (2)		○ (2)	
● Spark plug	Check-Adjust				○		
	Replace					○	
Propeller (power pin)	Check		○				
Anode (Trim tab)	Check		○				
Lubrication	Grease			○ (1)	○ (1)		

10. MAINTENANCE

REGULAR SERVICE PERIOD (3) Perform at every indicated month or operating hour interval, whichever comes first.		Each use	First month or 20 hrs.	Every 6 months or 100 hrs.	Every year or 200 hrs.	Every 2 years or 400 hrs.
ITEM						
●	Fuel tank and tank filter	Clean			○	
	Thermostat	Check			○ (2)	
●	Fuel filter	Check		○		
		Change				○
●	Fuel line	Check	○			
		Check (Replace if necessary)		Every 2 years (2)		
	Battery and cable	Check	○	○		
	Bolts and Nuts	Check-tightness	○ (2)	○ (2)		
●	Crank case breather tube	Check			○ (2)	

● Emission-related items

- NOTE:**
- (1) Lubricate more frequently when used in salt water.
 - (2) These items should be serviced by an authorized Honda marine dealer, unless you have the proper tools and are mechanically proficient. Refer to Honda Shop Manual for service procedures.
 - (3) For professional commercial use, log hours of operation to determine proper maintenance intervals.

Engine Oil

Engine oil is a major factor affecting engine performance and service life.

Oil check interval:

Each use.

Oil change interval:

After the first 20 hours or 1 month, then every 100 hours or 6 months. (Refer to the maintenance schedule page 87).

OIL CAPACITY:

2.1 US qt (2.0 ℓ, 1.8 Imp qt)
. . . When oil filter is not replaced

2.5 US qt (2.4 ℓ, 2.1 Imp qt)
. . . When oil filter is replaced

Recommended oil:

BF40A/50A...SAESW-30 engine oil,
API Service classification Fuel Efficient
SG, SH.

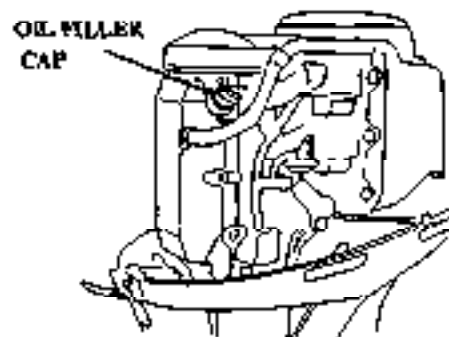

Engine Oil Replacement

Drain the oil while the engine is still warm to assure rapid and complete draining.

1. Position the outboard motor vertically, and remove the engine cover. Remove the oil filler cap.

10. MAINTENANCE

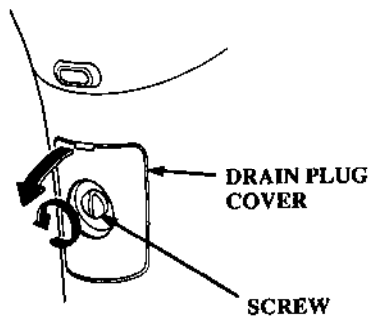

2. Loosen the drain plug cover screw using a flat blade screwdriver and remove the drain plug cover.

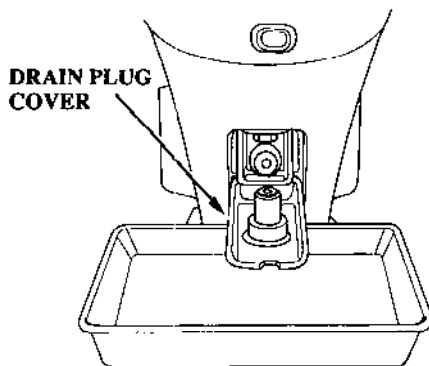

3. Place the drain plug cover as shown to use it as an oil drain guide. Place a suitable container under the guide.

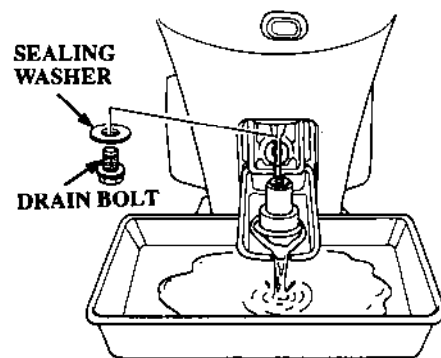

4. Remove the engine oil drain bolt and washer using a 12 mm wrench and drain the engine oil.
5. Install a new sealing washer on the drain bolt and tighten the bolt securely.
6. Reinstall the drain plug cover.

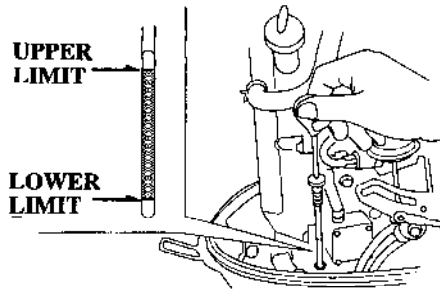

7. Refill to the upper limit mark on the oil level dipstick with the recommended oil.

NOTE: To avoid incorrect gauging of the engine oil level, inspect the oil level when the engine has cooled. The outboard motor needs to be in the vertical position.

8. Reinstall the oil filler cap.

Always wash your hands after handling used oil.

Also, please dispose of used motor oil in a manner that is compatible with the environment. We suggest you take it in a sealed container to your local service station reclamation center. Do not throw it in the trash, pour it on the ground, down a drain, or into the water.

Gear Oil

Oil check interval:

Every 100 hours or 6 months.

Oil change interval:

After the first 20 hours or 1 month, then every 200 hours or 1 year. (Refer to the maintenance schedule page 87).

OIL CAPACITY:

0.53 US qt (0.5 l, 0.44 Imp qt)

Recommended oil:

Outboard motor SAE 90 hypoid gear oil API Service Classification (GL-4 or GL-5).

10. MAINTENANCE

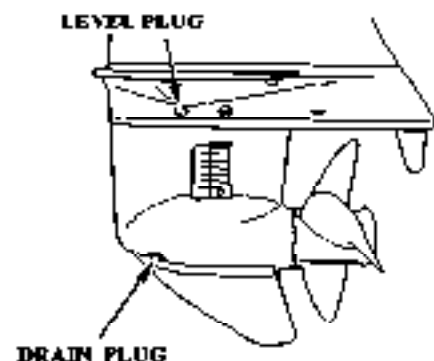

Gear Oil Level/Check

1. Position the outboard motor vertically.
2. Remove the level plug and see if oil flows out. If no oil flows out, fill through the drain plug hole until the oil starts to flow out through the level plug hole. If there is water in the oil, the water will flow out first when the drain plug is removed, or the oil will be milky colored. If the oil appears abnormal contact your closest authorized Honda Marine dealer.



A gear oil bottle is recommended to fill the gear case.

The end of the drain plug is a magnet. Remove all metal particles from the end of the drain plug before reinstalling. Do not reinstall the drain plug in the level plug hole.

3. Use new sealing washers and reinstall the level plug and drain plug securely.

Gear Oil Change

1. Position the outboard motor vertically.
2. Remove the level plug and drain plug to drain the oil. Inject oil through the drain plug hole until it starts flowing out through the level plug hole. Use new sealing washers and reinstall the level plug first and then the drain plug securely.

OIL CAPACITY:

0.55 US qt (0.5 £, 0.44 Imp qt)

Spark Plugs

To ensure proper engine operation, the spark plugs must be properly gapped and free of deposits.

Check-Adjust Interval:

Every 100 hours or 6 months.

Replace interval:

Every 200 hours or 1 year.

(Refer to the maintenance schedule page 87.)

Recommended spark plug:

DR7EA (NGK),

X22ESR-U (DENSO)

Use only the recommended spark plugs or equivalent.

NOTICE Spark plugs which have an improper heat range may cause engine damage.

1. Allow the engine to cool. The spark plugs will be hot if the engine has been running.
2. Remove the engine cover.

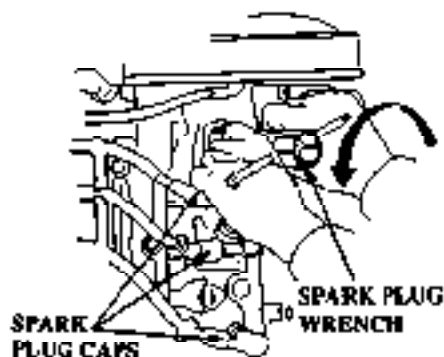

3. Disconnect the spark plug caps from the spark plugs.
4. Use the wrench and screwdriver supplied in the tool kit to remove the spark plugs.
5. Check the spark plugs. Replace the spark plugs if there is apparent wear, or if the insulators are cracked or chipped. Clean the spark plugs with a wire brush if they are to be reused.

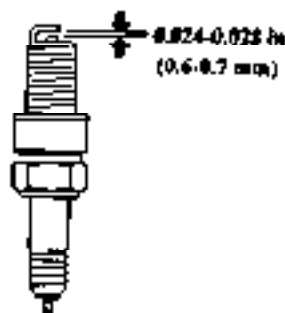

6. Measure the plug gaps with a spark plug gap gauge. The gaps should be 0.024-0.028 in (0.6-0.7 mm). Correct as necessary by carefully bending the side electrode.

10. MAINTENANCE

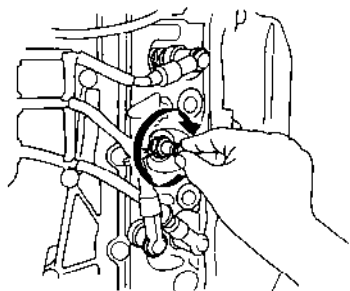

7. Thread the plugs in by hand to prevent cross threading.

8. After the spark plugs are seated, tighten with a spark plug wrench to compress the washers.

If installing new spark plugs, tighten $1/2$ turn after the spark plugs seat to compress the washers. If reinstalling used spark plugs, tighten $1/8 \sim 1/4$ turn after the spark plugs seat to compress the washers.

NOTICE *The spark plugs must be securely tightened. A loose spark plug can become very hot and may cause engine damage. Overtightening the spark plugs can damage the threads.*

Battery (not included) Minimum requirements

12V-70AH marine cranking battery.

To protect the battery from mechanical damage and to prevent the battery from falling or tipping over, the battery must be:

- Installed in the correct size corrosion-resistant battery box.
- Properly secured in the boat.
- Secured in a location free from direct sunlight and water spray.
- Secured away from the fuel tank to avoid potential sparks near the fuel tank.

1. Install the battery in the battery box.
2. Connect the positive (+) battery cable first, then connect the negative (-) battery cable. Tighten the cable nuts securely.
3. Coat the battery terminals and cable ends with marine anticorrosion grease.
4. Put the cover on the battery box and secure the battery box to the boat.

Lubrication

Lubrication interval: After the first 20 hours or 1 month, then every 100 hours or 6 months. (Refer to the maintenance schedule page 87.)

Apply marine anticorrosion grease to the following parts:

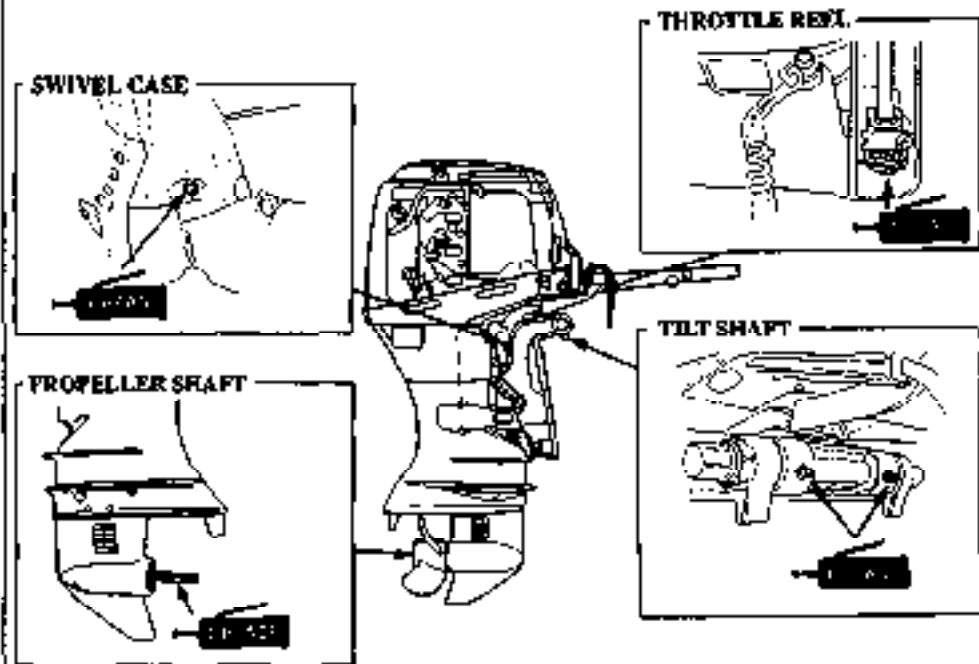

10. MAINTENANCE

Engine Fuel Filter

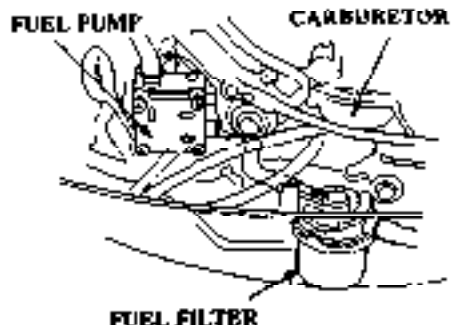

The engine fuel filter is located under the engine cover between the fuel coupling and the fuel pump. Water or sediment accumulated in the fuel filter can cause loss of power or hard starting.

Check interval:

Every 100 hours or 6 months (Refer to the maintenance schedule page 88.)

Change interval:

Every 400 hours or 2 years (Refer to the maintenance schedule page 88.)

WARNING Gasoline is extremely flammable, and gasoline vapor can explode, causing serious injury or death. Do not smoke or allow flames or sparks in your working area. **KEEP OUT OF REACH OF CHILDREN.**

Always work in a well-ventilated area. Make sure that any fuel drained from the outboard motor is stored in an approved gasoline container. Be careful not to spill any fuel when replacing the filter. Spilled fuel or fuel vapor may ignite. If any fuel is spilled, make sure the area is dry before starting the engine.

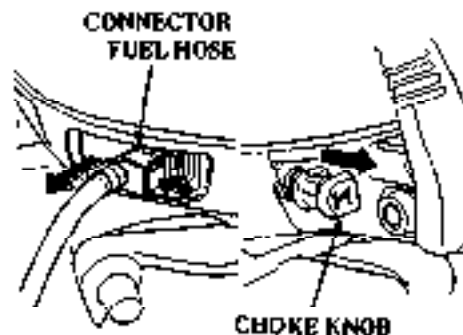

Check

1. Disconnect the fuel hose connector from the outboard motor.
2. Pull the choke knob fully and remove the engine cover.

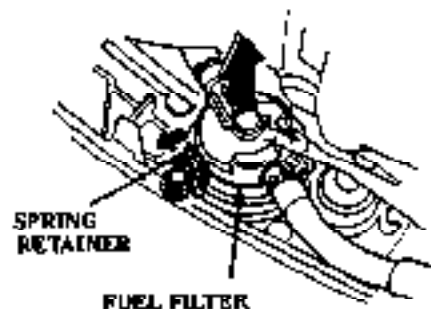

3. Pull the spring retainer toward you, and raise the fuel filter.

4. Check the fuel filter for water accumulation or sediment. If no water or sediment are found, reinstall the fuel filter properly.

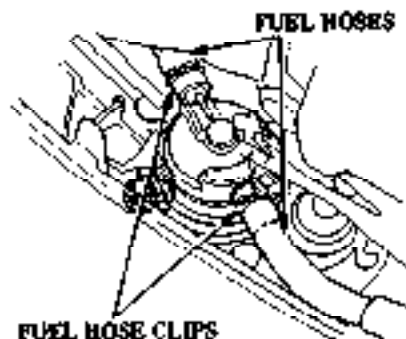

Change

1. Remove the fuel filter.

Before removing the fuel filter, to prevent fuel leakage, place fuel hose clamps on the fuel hoses at each side of the fuel filter.



2. Install the new fuel filter so the arrow on the fuel filter points toward the fuel pump.

Fuel flow will be reduced if the fuel filter is installed backward.

3. Connect the fuel hoses to the fuel filter securely with the hose clips. Remove the fuel hose clamps used to close the fuel hoses.

10. MAINTENANCE

4. Securely connect the fuel hose connector to the outboard motor (refer to page 38).
5. Prime the engine using the primer bulb (refer to page 39). Check for fuel leaks.
Repair any fuel leaks if necessary.

If loss of power or hard starting are found to be caused by excessive water or sediment accumulation in the fuel filter, inspect the fuel tank.

Clean the fuel tank and tank filter if necessary. It may be necessary to drain the fuel tank completely and refill with fresh gasoline.

Fuel Tank and Filter

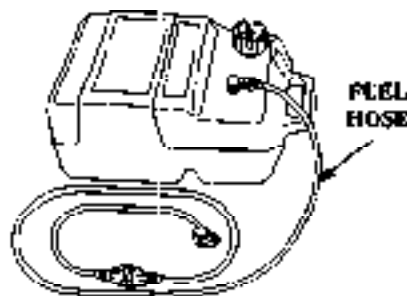

Cleaning interval:

Every 200 hours or 1 year (Refer to the maintenance schedule page 88).

Inspect the condition of the fuel cap gasket, fuel hose, and the O-ring seals in the fuel hose connectors. Replace the fuel cap gasket, hose, or fuel connectors if they are cracked, damaged or leak fuel. Be sure the fuel hose is not kinked.

Fuel Tank Cleaning

1. Disconnect the fuel hose from the fuel tank.

WARNING: Gasoline is extremely flammable, and gasoline vapor can explode, causing serious injury or death. Do not smoke or allow flames or sparks in your working area. **KEEP OUT OF REACH OF CHILDREN.**

2. Empty the gasoline from the fuel tank into an approved gasoline container. Pour in a small quantity of fresh gasoline, and clean the tank thoroughly. Drain and dispose of the gasoline properly.

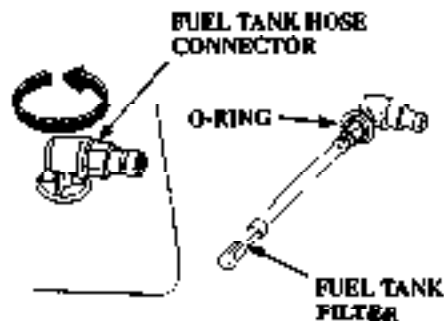

Fuel Tank Filter Cleaning/Replacement

1. Turn the fuel tank hose connector counterclockwise to remove the fuel tank filter.
2. Clean the fuel tank filter with non-flammable cleaner or solvent. Replace the fuel tank filter if necessary.
3. After cleaning or replacement, reinstall the fuel tank filter and fuel tank hose connector securely.

Fuse Replacement

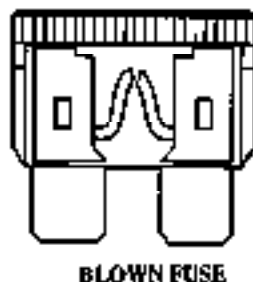

If the fuse is blown, running the engine will not charge the battery and the electric starter and power trim/tilt will not work.

FUSE RATING: 15A

Never use a fuse with a different rating from that specified. If the fuse is blown, check the cause, then replace the fuse with a spare fuse of the same rated capacity. Unless the cause is found, the fuse may blow again.

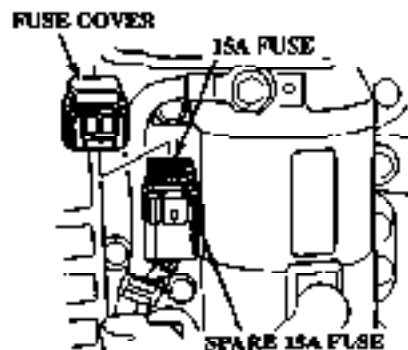

Replacement

1. Stop the engine.
2. Remove the engine cover.
3. Pull the blown fuse out of the clip.
4. Push a new 15A fuse into the clip.

A spare 15A fuse is located in the fuse holder. If the spare fuse is not available, the motor will need to be started with the pull starter rope (refer to the emergency start procedure page 47).

10. MAINTENANCE

Propeller

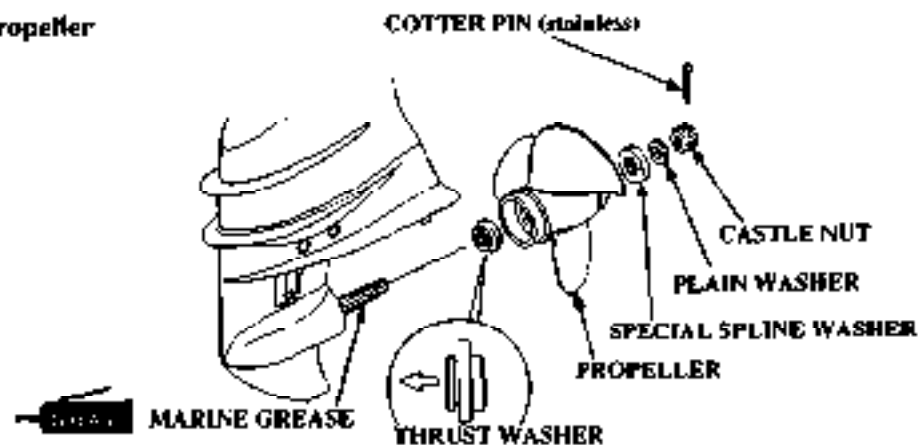

If the propeller is damaged, replace it as follows:

WARNING:

- Before replacing the propeller, remove the emergency stop switch clip to prevent accidental engine starting.
- The propeller is thin and sharp. To protect your hands, wear the heavy gloves during replacement.

Removal:

Remove the cotter pin then remove the 16 mm castle nut, 17 mm plain washer, 10 mm special spline washer, propeller and thrust washer.

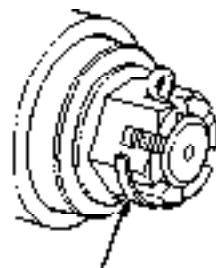

COTTER PIN (stainless)

Installation:

Install the thrust washer with the grooved side toward the gear case, then install the new propeller in the reverse sequence of removal.

Hand tighten the castle nut until the 4 mm cotter pin can be installed. If necessary, tighten the castle nut just enough to align the hole with the groove in the nut.

Use a new genuine Honda cotter pin and bend the cotter pin ends as shown.

Submerged Motor

A submerged motor must be serviced immediately after it is recovered from the water in order to minimize corrosion. Immediately take the outboard motor to the closest authorized Honda Marine dealer or if you are far from a dealership, proceed as follows:

1. Remove the engine cover, and rinse the motor with fresh water to remove salt water, sand, mud, etc.
2. Drain the carburetors (Refer to Storage page 103).
3. Disengage the emergency stop switch clip from the emergency stop switch.
4. Remove the spark plugs.

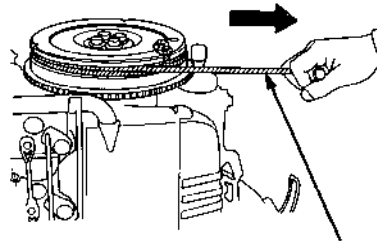

EMERGENCY STARTER ROPE

5. Remove the flywheel cover following the emergency starting procedure (refer to page 47) and remove the water from the cylinders by pulling the emergency starter rope several times. If the motor was running when it submerged, there may be mechanical damage, such as bent connecting rods. If the engine binds when rotated with the emergency starter rope, do not proceed or attempt to run the motor until it has been repaired.

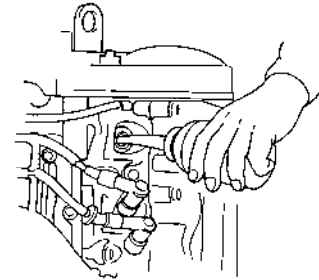

6. Change the engine oil (refer to page 89).
7. Put a teaspoon of engine oil into each spark plug hole to lubricate the inside of the cylinders. Then rotate the engine several times, using the emergency starter rope. Reinstall the spark plugs.

NOTICE *Running the outboard motor without sufficient cooling water will damage the water pump and overheat the engine.*

10. MAINTENANCE

8. Engage the emergency stop switch clip with the emergency stop switch and attempt to start the engine (be sure the water level is at least 2 inches above the anti-ventilation plate).
- If the engine fails to start, remove the spark plugs, clean and dry the electrodes, then re-install the spark plugs and attempt to start the engine again.
 - If the engine starts, and no mechanical damage is evident, continue to run the engine for a 1/2 hour or longer.
 - If there was water in the engine crankcase, or the used engine oil showed signs of water contamination, then a second engine oil change should be performed after running the engine for a 1/2 hour.
9. Take the outboard motor to your closest authorized Honda Marine dealer for inspection and service as soon as possible.

11. STORAGE/WINTERIZATION

For longer service life of the outboard motor, have your outboard motor serviced by an authorized Honda Marine dealer before storage.

If you are unable to take the motor to your dealer, proceed as follows.

Draining the Carburetors

Be careful not to spill gasoline. Spilled gasoline or gasoline vapor may ignite. If any gasoline is spilled, make sure the area is dry before storing or transporting the motor. Do not smoke or allow flames or sparks where gasoline is drained or stored.

⚠️ WARNING Gasoline is extremely flammable, and gasoline vapor can explode, causing serious injury or death. Do not smoke or allow flames or sparks in your working area, **KEEP OUT OF REACH OF CHILDREN.**

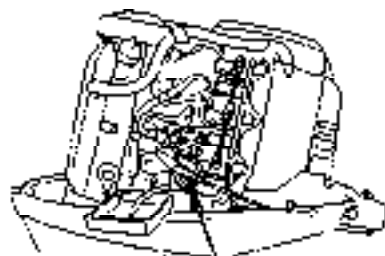

DRAIN SCREW

1. Disconnect the fuel hose connector.
2. Pull the #3 carburetor drain hose outside of the motor pan.
3. Loosen the drain screw of the #3 carburetor and drain the carburetor. Catch the draining gasoline in an approved gasoline container.
4. Drain the #1 and #2 carburetors in the same manner using the #3 carburetor drain hose.

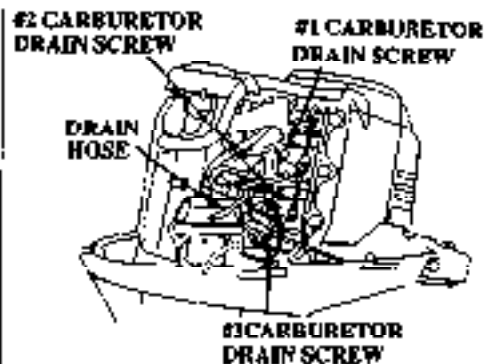

5. After thoroughly draining the carburetors, tighten the drain screws securely.
6. Reinstall the drain hose back on the #3 carburetor.

11. STORAGE/WINTERIZATION

Fuel Tank

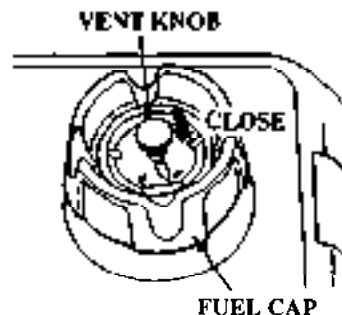

1. Close the fuel cap vent knob.
2. Disconnect the fuel coupling from the outboard motor (refer to page 38).

Outboard Motor Position

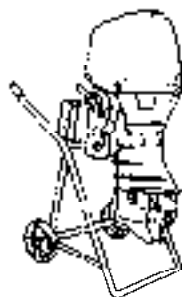

Transport and store the motor either vertically or horizontally, as shown above. Store the outboard motor in a well-ventilated area free from direct sunlight and humidity.

Vertical transport or storage:
Attach the stern bracket to stand



CASE PROTECTORS

Horizontal transport or storage:
Rest the motor on the case protectors.

NOTICE *Improper transport or storage can damage the motor or cause oil leakage.*

(1) Engine does not start.

Fuel

• Fuel is not fed to carburetor.

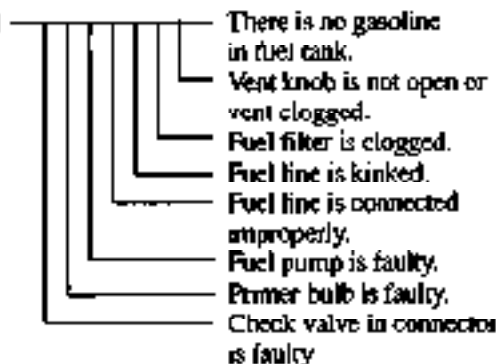

• Fuel is fed to carburetor.

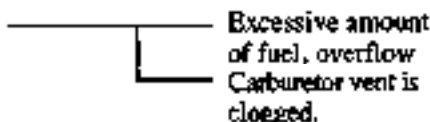

Electrical

• Sparks across spark plug gap

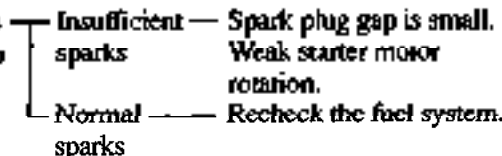

• No sparks across spark plug gap

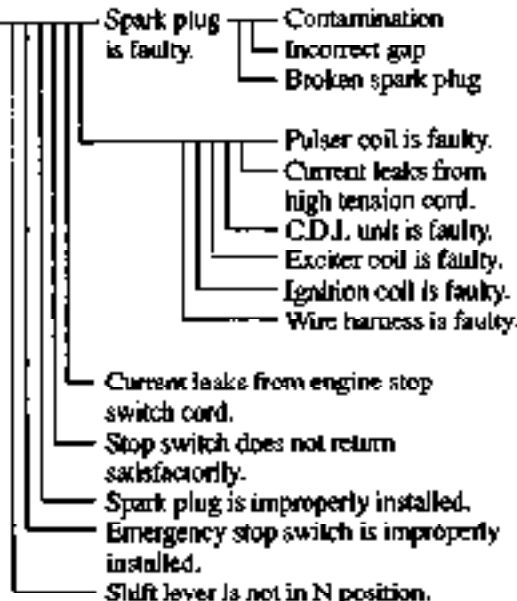

12. TROUBLESHOOTING

(2) Engine starts but immediately stops. Engine sometimes stops while cruising.

Fuel

- No gasoline in fuel tank.
- There is gasoline in fuel tank.

- Water is mixed with gasoline
- Vent knob is not open or vent is clogged.
- Fuel filter is clogged.
- Air screw is open too wide.
- Idling speed is too slow.
- Carburetor vent is clogged.
- Fuel pump is faulty.
- Air in fuel pump.
- Air enters through fuel line connector.
- Air enters through primer bulb.

Engine overheats

- Normal sparking

- Water intake screens are clogged.
- Spark plug is not of specified rating.
- Water pump is faulty.
- Thermostat is clogged.
- Thermostat is faulty.
- Water tube or passage is clogged.
- Exhaust gas is entering cooling system.

13. SPECIFICATIONS

MODEL	BF40A				
Description Code	BAYS				
Type	H	R	HT	RT	
Overall length	28.6 in (725 mm)	27.0 in (685 mm)	28.6 in (725 mm)	27.0 in (685 mm)	
Overall width	14.6 in (370 mm)				
Overall height	L	53.6 in (1,360 mm)			
	X	57.5 in (1,460 mm)			
Transom height	L	20.5 in (520 mm)			
	X	24.5 in (622 mm)			
Weight	L	201 lb (91 kg)	198 lb (90 kg)	205 lb (93 kg)	203 lb (92 kg)
	X	—			212 lb (96 kg)
Rated power	40 PS (29.4 kW)				
Full throttle range	5,000 – 6,000 rpm				
Engine type	4 stroke OHC in-line 3 cylinder				
Displacement	49.3 cu-in (808 cm ³)				
Spark plug gap	0.024 – 0.028 in (0.6 – 0.7 mm)				

Starter system	Electric starter
Ignition system	C.D.I
Lubrication system	Trochoid pump pressure lubrication
Specified oil	Engine: API standard (Fuel Efficient SG, SH) SAE 5W-30
	Gear case: API standard (GL-4/5) SAE 90 outboard motor gear oil
Oil capacity	Engine: 2.5 US qt (2.4 ℓ, 2.1 Imp qt) Gear case: 0.53 US qt (0.5 ℓ, 0.44 Imp qt)
D.C. output	12 V—10 A
Cooling system	Water cooling with thermostat
Exhaust system	Thru-hub
Spark plugs	DR7EA (NGK), X22ESR-U (DENSO)
Fuel pump	Diaphragm type
Fuel	Automotive gasoline (86 pump octane)
Tank capacity	6.6 US gal (25 ℓ, 5.5 Imp gal)
Gear change	Forward—Neutral—Reverse (dog type)
Steering angle	37.5° right and left
Transom angle	5 stages (11.5°, 15.5°, 19.5°, 23.5°, 27.5°)

13. SPECIFICATIONS

MODEL	BF30A		
Description Code	BAZS		
Type	R	HT	RT
Overall length	27.0 in (685 mm)	28.6 in (725 mm)	27.0 in (685 mm)
Overall width	14.6 in (370 mm)		
Overall height	L	53.6 in (1,360 mm)	
	X	57.5 in (1,460 mm)	
Transom height	L	20.5 in (520 mm)	
	X	24.5 in (622 mm)	
Weight	L	198 lb (90 kg)	205 lb (93 kg)
	X	212 lb (96 kg)	
Rated power	50 PS (36.8 kW)		
Full throttle range	5,500 - 6,000 rpm		
Engine type	4 stroke OHC in-line 3 cylinder		
Displacement	49.3 cu in (808 cm ³)		
Spark plug gap	0.024 - 0.028 in (0.6 - 0.7 mm)		

Starter system	Electric starter
Ignition system	C.D.I
Lubrication system	Trochoid pump pressure lubrication
Specified oil	Engine: API standard (Fuel Efficient SG, SH) SAE 5W-30 Gear case: API standard (GL-4/5) SAE 90 outboard motor gear oil
Oil capacity	Engine: 2.5 US qt (2.4 l, 2.1 imp qt) Gear case: 0.53 US qt (0.5 l, 0.44 imp qt)
D.C. output	12 V—10 A
Cooling system	Water cooling with thermostat
Exhaust system	Thru-hub
Spark plugs	DR7EA (NGK), X22BSR-U (DENSO)
Fuel pump	Diaphragm type
Fuel	Automotive gasoline (86 pump octane)
Tank capacity	6.6 US gal (25 l, 5.5 imp gal)
Gear change	Forward—Neutral—Reverse (dog type)
Steering angle	37.5° right and left
Transom angle	5 stages (11.5°, 15.5°, 19.5°, 23.5°, 27.5°)

13. SPECIFICATIONS

BF40A&BF50A Tuneup

Spark plug gap	0.024 – 0.028 in (0.6 – 0.7 mm)	See page 93.
Idle speed	950 ± 50 rpm	See shop manual.
Valve clearance (cold)	Intake: 0.15 ± 0.02 mm Exhaust: 0.23 ± 0.02 mm	See shop manual.
Other specifications	No other adjustments needed.	

14. WARRANTY SERVICE

Warranty Service Information

Serviceing dealership personnel are trained professionals. They should be able to answer any question you may have. If you encounter a problem that your dealer does not solve to your satisfaction, please discuss it with the dealership's management.

The Service Manager or General Manager can help. Almost all problems are solved in this way.

If you are dissatisfied with the decision made by the dealership's management, contact the Honda Marine Customer Relations Office. You can write:

American Honda Motor Co., Inc.
Marine Division
Customer Relations Office
4900 Marconi Drive
Alpharetta, Georgia 30005-8847
Or telephone: (770) 497-6400

When you write or call, please give us this information:

- Model and serial numbers (see page 4).
- Name of the dealer who sold the outboard motor to you.
- Name and address of the dealer who services your outboard motor.
- Date of purchase.
- Your name, address, and telephone number.
- A detailed description of the problem.

15. WIRING DIAGRAM

TILLER HANDLE TYPE

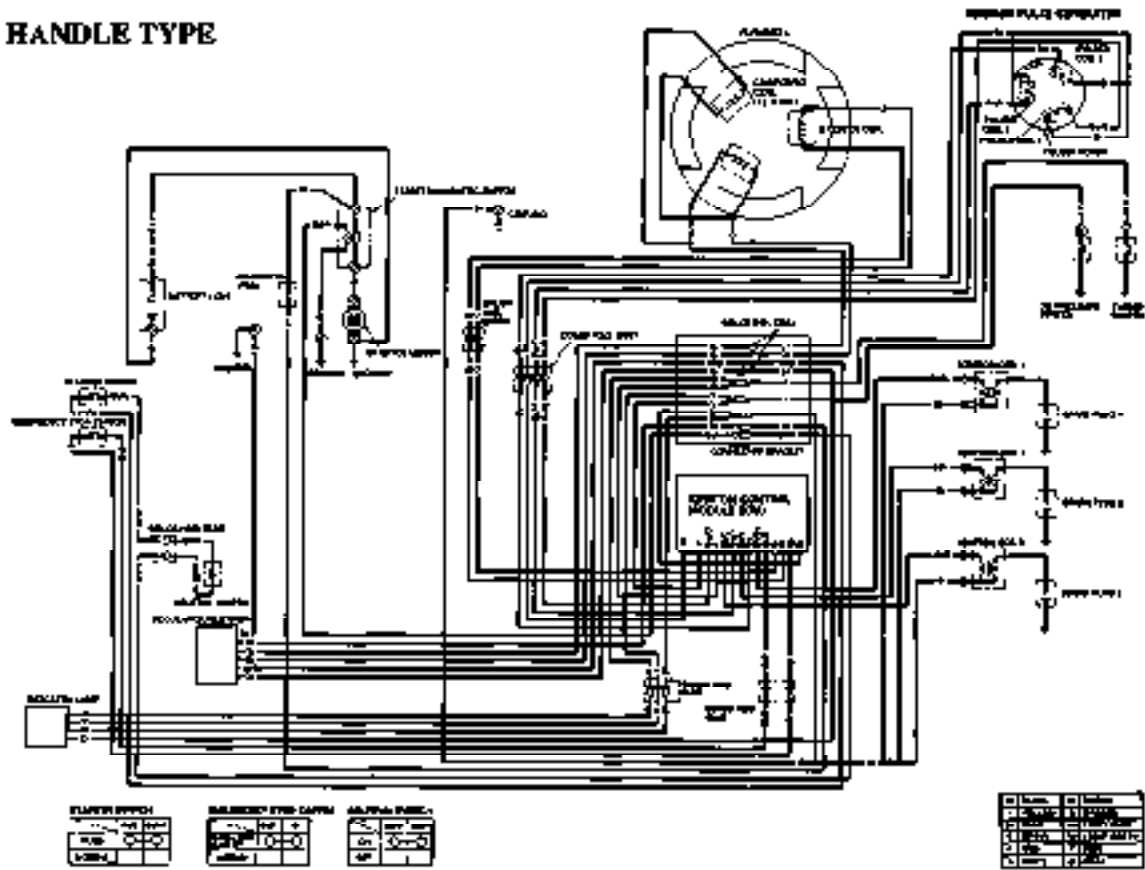

15. WIRING DIAGRAM

REMOTE CONTROL TYPE

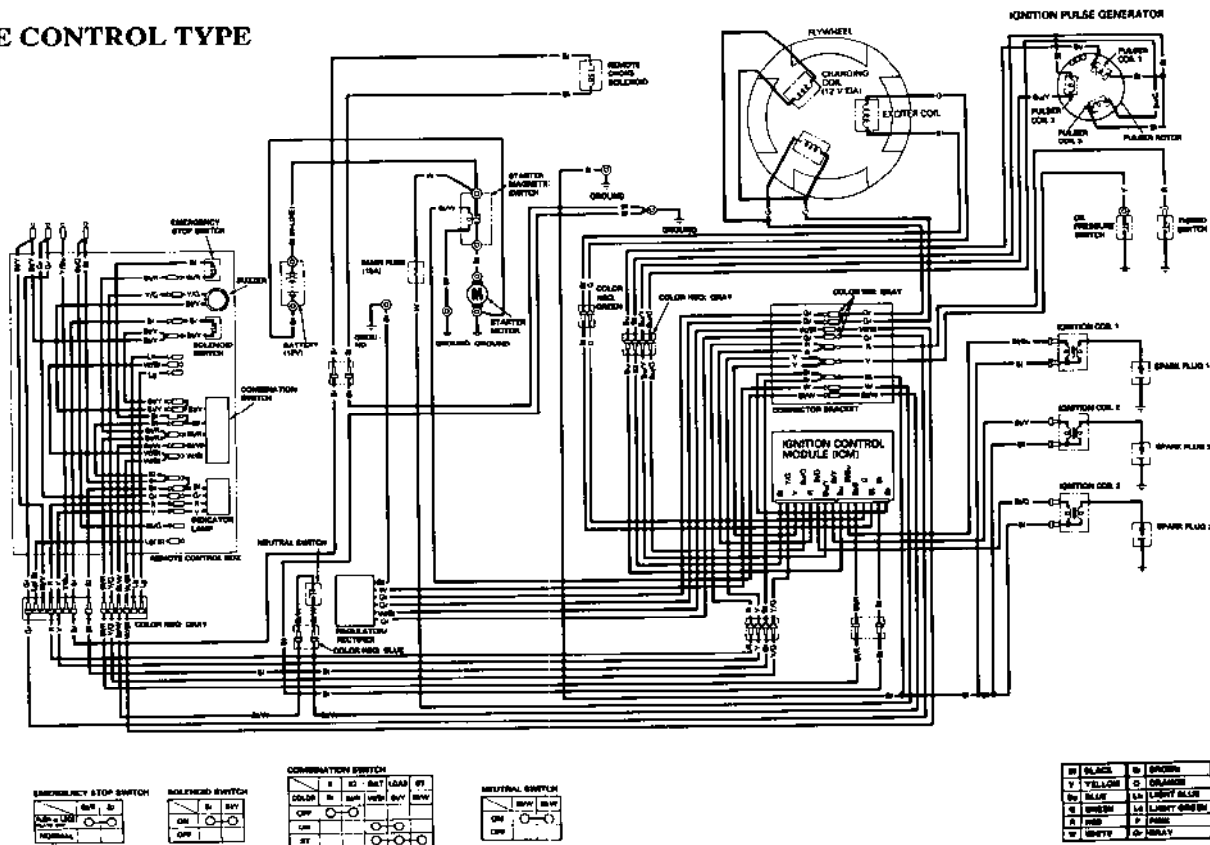

15. WIRING DIAGRAM

REMOTE CONTROL,
POWER TRIM/TILT
TYPE

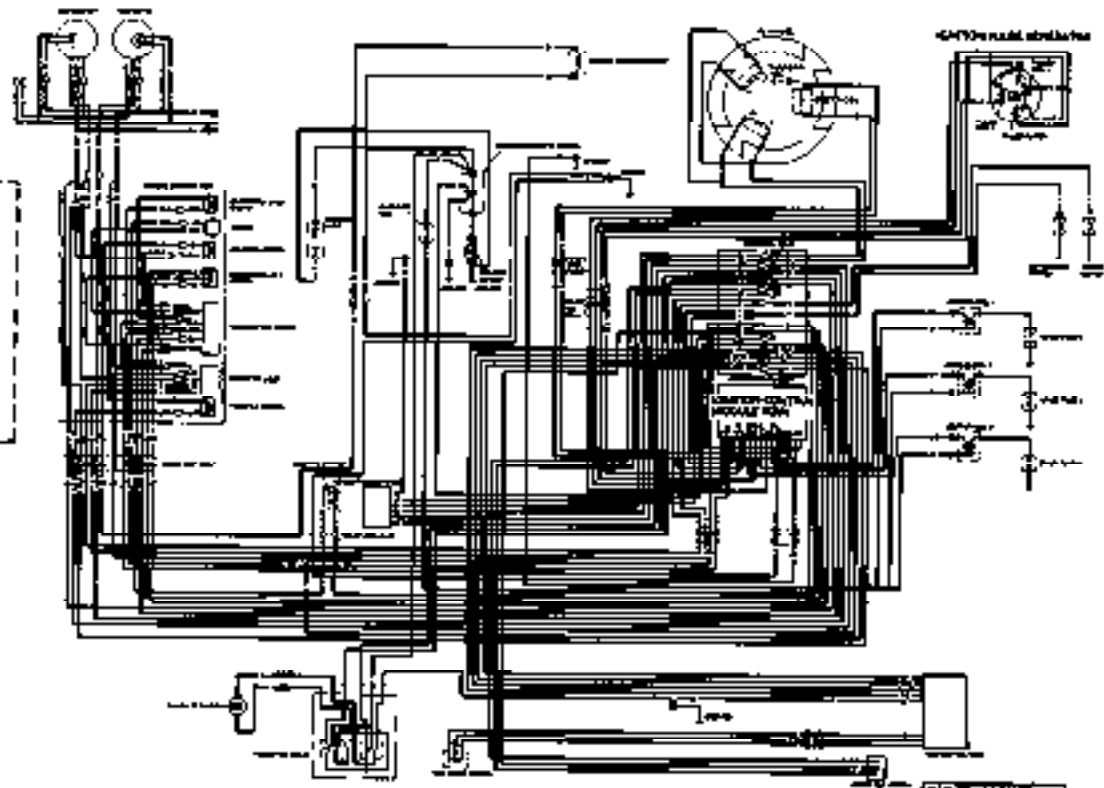
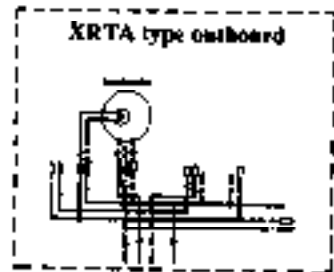

16. INDEX

Anode Metal	26	Over-Rev Limiter	29
PRE-OPERATION CHECK	37	Start Button	13
MOTOR PROTECTION SYSTEM	71	Stop Switch	15
Battery (not included)	94	Fuel	
Break-in Procedure	53	Cup/Gauge/Vent/Knob	29
Choke Knob	13	Level	32
Choke/Fast Idle Lever	20	Line Connection	38
CLEANING AND FLUSHING	78	Tank and Filter	98
COMPONENT IDENTIFICATION	10	Tank and Vent Knob	38
CONTROLS		Fuel Recommendations	33
COMMON	25	Fuse Replacement	99
GAS ASSISTED TILT TYPE	25	Clear Oil	91
TILLER HANDLE TYPE	13	Gear Shifting	
REMOTE CONTROL TYPE	17	TILLER HANDLE TYPE	54
POWER TRIM/TILT TYPE	22	REMOTE CONTROL TYPE	57
Cooling System Indicator	27	High Altitude Operation	73
Cruising		Ignition Switch	18
TILLER HANDLE TYPE	53	Lubrication	95
REMOTE CONTROL TYPE	58	MAINTENANCE	80
Emergency Starting	47	EMISSION CONTROL SYSTEM INFORMATION	81
Emergency Stop Switch Lanyard		MAINTENANCE SAFETY	80
TILLER HANDLE TYPE	15	SCHEDULE	82
REMOTE CONTROL TYPE	19	THE IMPORTANCE OF MAINTENANCE	80
Engine Cover Removal/Installation	30	Manual	
Engine Fuel Filter	96	Choke Knob	20
Engine		Relief Valve	
Oil		CONTROLS	24
Level Check	31	OPERATION	65
Change	89	MOTOR PROTECTION SYSTEM	68
Pressure and Overheat Warning System	68		

Neutral Release Lever	18	Steering	55
Oil Pressure Indicator Light	16	Friction Adjustment (common)	36
Oil Pressure Indicator Light/Buzzer	21	Stein bracket	
Other Checks	37	PRE-OPERATION CHECK	37
OUTBOARD MOTOR SAFETY		STOPPING THE ENGINE	
IMPORTANT SAFETY INFORMATION	7	REMOTE CONTROL TYPE	76
SAFETY LABEL LOCATIONS	9	TILLER HANDLE TYPE	74
Over-Rev Limiter	70	STORAGE/WINTERIZATION	105
Overheat Indicator Light	16	Submerged Motor	101
Overheat Indicator Light/Buzzer	21	Tachometer	24
Oxygenated Fuels	34	Throttle	
Power Tilt Switch (Motor Pan)		Friction Knob	14
CONTROLS	23	Grip	14
OPERATION	65	Opening Indicator	14
Power Trim Warning System	70	Tilt Lever	25
Power Trim Tilt Switch	22	Tilt Lock Lever	
PRE-OPERATION CHECKS	30	CONTROLS	25
Propeller	100	OPERATION	56
Cutter Pin	35	Tilting motor	
Remote Control		GAS ASSISTED TILT TYPE	59
Friction Adjustment	36	POWER TRIM/TILT TYPE	62
Lever	17	Tool Kit	37
Shallow Water Operation	72	Tool Kit and Spare Parts	86
Shift Lever	13	Transom Angle Adjusting Rod	28
Spark Plug	93	TRANSPORTING	77
SPECIFICATIONS	107	Trim Meter	
STARTING THE ENGINE		Controls	23
REMOTE CONTROL TYPE	44	Operation	64
TILLER HANDLE TYPE	40	Trim Tab	25

16. INDEX

Trim Tab Adjustment	67
TROUBLESHOOTING	105
Starting Problems	52
WARRANTY SERVICE	110
Water Intakes	27
WIRING DIAGRAM	111

<https://www.boat-manuals.com/>

31ZW4604
00X31-ZW4-6040



CC 30.2002.06
PRINTED IN U.S.A