

NISSAN
MARINE

OUTBOARD MOTOR

NSF4C/5C/6C

OWNER'S OPERATING MANUAL

ENOM00001-0



READ THIS MANUAL BEFORE USING THE OUTBOARD MOTOR. FAILURE TO FOLLOW THE INSTRUCTIONS AND SAFETY PRECAUTIONS IN THIS MANUAL CAN RESULT IN SERIOUS INJURY OR DEATH. KEEP THIS MANUAL IN A SAFE LOCATION FOR FUTURE REFERENCE.

Copyright © 2009-2012 Nissan Marine Co., Ltd. All rights reserved. No part of this manual may be reproduced or transmitted in any form or by any means without the express written permission of Nissan Marine Co., Ltd.

<https://www.boat-manuals.com/>

YOUR NISSAN MARINE OUTBOARD MOTOR

ENOM00002-0

OWNER REGISTRATION AND IDENTIFICATION

Upon purchasing this product, be sure that the WARRANTY CARD is correctly and completely filled out and mailed to the addressee noted there on. This WARRANTY CARD identifies you as the legal owner of the product and serves as your warranty registration.

TO THE EXTENT PERMITTED BY APPLICABLE LAW, YOUR OUTBOARD MOTOR WILL NOT BE COVERED BY THE APPLICABLE LIMITED WARRANTY, IF THIS PROCEDURE IS NOT FOLLOWED.

ENOM00003-0

PRE-DELIVERY CHECK

Be sure that the product has been checked by an authorized NISSAN MARINE dealer before you take delivery.

ENOM00004-0

Limited Warranty

Please refer to the NISSAN MARINE outboard motor Limited warranty provided to you with this product, the terms and conditions of which, as amended from time to time, are incorporated by reference into the manual.

ENOM00005-0

Serial Number

In the space below, please record the outboard motor's serial number (indicated both on the lower motor cover and on the cylinder block). The serial number will be needed in the event of theft or to quickly identifying the outboard motor type.

Serial Number:

ENOM00006-0

To You, Our Customer

Thank you for selecting a NISSAN MARINE outboard motor. You are now the proud owner of an excellent outboard motor that will service you for many years to come.

This manual should be read in its entirety and the inspection and maintenance procedures described later in this manual should be followed carefully. Should a problem arise with the outboard motor, please follow the troubleshooting procedures listed at the end of this manual. If the problem persists, contact an authorized NISSAN MARINE service shop or dealer.

We hope you will enjoy your outboard motor and wish you good luck in your boating adventures.

NISSAN MARINE

CONTENTS

GENERAL SAFETY INFORMATION	8
1. SPECIFICATIONS	10
2. NAMES OF PARTS	11
3. LOCATIONS OF WARNING LABELS	12
4. INSTALLATION	15
1. Mounting the outboard motor on boat	15
2. Installing the remote control devices	16
5. PRE-OPERATING PREPARATIONS	17
1. Recommended gasoline types	17
2. Low permeation fuel hose requirement	18
EQUIPPED FOR UNITED STATES AND CANADA MODEL	
3. EPA pressurized fuel tank requirements	19
EQUIPPED FOR UNITED STATES AND CANADA MODEL	
4. EPA approval Primer valve/hose assembly	19
EQUIPPED FOR UNITED STATES AND CANADA MODEL	
5. Recommended engine oil	20
6. Altitude adjustment kit requirement	20
7. Break-In	21
8. Engine oil warning lamp	22
9. ESG (A device preventing over revolution)	22
6. ENGINE OPERATION	23
Before starting	23
1. Filling the fuel	23
2. Feeding the fuel	26
3. Starting	28
4. Warming up the engine	31
5. Forward and reverse	31
6. Stopping	33
7. Trim angle	33
8. Tilt up, tilt down and shallow water operation	35
9. Shallow water operation	36
7. REMOVING AND CARRYING THE OUTBOARD MOTOR	38
1. Removing the outboard motor	38
2. Carrying the outboard motor	38
3. Storing the outboard motor	38
8. TRAILERING	39
9. ADJUSTMENT	40
1. Steering friction	40
2. Throttle grip	40
10. INSPECTION AND MAINTENANCE	41
1. Daily Inspection	42
2. Periodic inspection	47
3. Off-season storage	51

4. Pre-season check	52
5. Motor submerged in water.	52
6. Cold weather precautions	53
7. Checking after striking underwater object.	53
11. TROUBLESHOOTING	54
12. TOOL KIT AND SPARE PARTS	56
13. OPTIONAL ACCESSORIES	57
14. PROPELLER TABLE	58

INDEX

GENERAL SAFETY INFORMATION

1. SPECIFICATIONS

.....

2. NAMES OF PARTS

.....

3. LOCATIONS OF WARNING LABELS

.....

4. INSTALLATION

.....

5. PRE-OPERATING PREPARATIONS

.....

6. ENGINE OPERATION

.....

7. REMOVING AND CARRYING THE OUTBOARD MOTOR

.....

8. TRAILERING

.....

9. ADJUSTMENT

.....

10. INSPECTION AND MAINTENANCE

.....

11. TROUBLESHOOTING

.....

12. TOOL KIT AND SPARE PARTS

.....

13. OPTIONAL ACCESSORIES

.....

14. PROPELLER TABLE

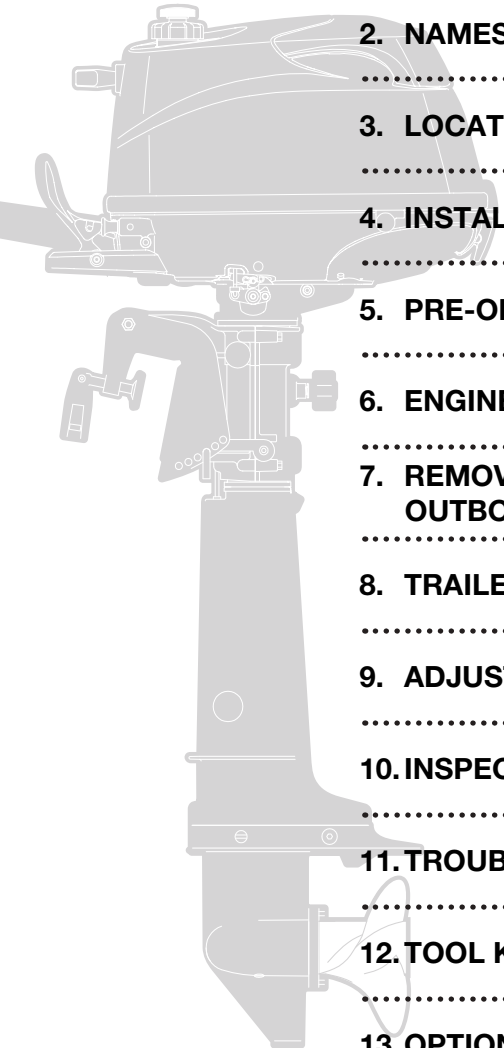

GENERAL SAFETY INFORMATION

ENOM00007-0

NOTICE: DANGER/WARNING/CAUTION/Note

Before installing, operating or otherwise handling your outboard motor, be sure to thoroughly read and understand this Owner's Manual and carefully follow all of the instructions. Of particular importance is information preceded by the words "DANGER," "WARNING," "CAUTION," and "Note." Always pay special attention to such information to ensure safe operation of the outboard motor at all times.

ENOW00001-0

DANGER

Failure to observe will result in severe personal injury or death, and possibly property damage.

ENOW00002-0

WARNING

Failure to observe could result in severe personal injury or death, or property damage.

ENOW00003-0

CAUTION

Failure to observe could result in personal injury or property damage.

ENON00001-0

Note

This instruction provides special information to facilitate the use or maintenance of the outboard motor or to clarify important points.

ENOM00008-0

EMERGENCY STOP SWITCH

The Emergency Stop Switch will stall the outboard motor when the stop switch tether is pulled off. This stop switch tether can be attached to the operator of the outboard motor to minimize or prevent injuries from the propeller in case the operator falls overboard. We highly recommend use of the Emergency Stop Switch tether.

ENOW00004-0

WARNING

Accidental activation of the Emergency Stop Switch (such as the tether being pulled out in heavy seas) could cause passengers to lose their balance and even fall overboard, or it could result in loss of power in heavy seas, strong currents, or high winds. Loss of control while mooring is another potential hazard.

To minimize accidental activation of the Emergency Stop Switch, the 500 mm (20 inch.) stop switch tether is coiled and can extended to a full 1300 mm (51 inch.).

ENOM00009-0

SAFE OPERATION OF BOAT

As the operator/driver of the boat, you are responsible for the safety of those aboard and those in other boats around yours, and for following local boating regulations. You should be thoroughly knowledgeable on how to correctly operate the boat, outboard motor, and accessories. To learn about the correct operation and maintenance of the outboard motor, please read through this manual carefully.

It is very difficult for a person standing or floating in the water to take evasive action should he or she see a power boat heading in his/her direction, even at a slow speed. Therefore, when your boat is in the immediate vicinity of people in the water, the outboard motor should be shifted to neutral and shut off.

ENOW00005-0



WARNING

SERIOUS INJURY IS LIKELY IF A PERSON IN THE WATER MAKES CONTACT WITH A MOVING BOAT, GEAR HOUSING, PROPELLER, OR ANY SOLID DEVICE RIGIDLY ATTACHED TO A BOAT OR GEAR HOUSING.

ENOM00010-0

SERVICING, REPLACEMENT PARTS & LUBRICANTS

We recommend that only an authorized service shop perform service or maintenance on this outboard motor. Be sure to use genuine parts, genuine lubricants, or recommended lubricants.

ENOM00011-0

MAINTENANCE

As the owner of this outboard motor, you should be acquainted with correct maintenance procedures. It is the operator's responsibility to perform all safety checks and to ensure that all lubrication and maintenance instructions are complied with for safe operation. Please comply with all instructions concerning lubrication and maintenance. You should take the engine to an authorized dealer or service shop for periodic inspection at the prescribed intervals.

Correct periodic maintenance and proper care of this outboard motor will reduce the chance of problems and limit overall operating expenses.

ENOM00012-0

MOUNTING

Outboard motor mounting must be performed by trained service person(s) using lift or hoist with sufficient capacity.

SPECIFICATIONS

EENOM00401-0

MF

Item	MODEL	4C(D) 5C(D) M6C(D) (Dual Tank)	5C(S) 6C(S) (Separate Tank)
Overall Length	mm (in)	783 (30.8)	
Overall Width	mm (in)	343 (13.5)	
Overall Height S-L-UL	mm (in)	Except for USA and Canada model 1053 (41.5) 1180 (46.5) 1307 (51.5)	1039 (40.9) 1166 (45.9)
		For USA and Canada model 1067 (42.0) 1194 (47.0) 1321 (52.0)	1293 (50.9)
Transom Height S-L-UL	mm (in)	435 (17.1) 562 (22.1)	689 (27.1)
Weight	S kg (lb)	26.1 (57.5)	25.6 (56.4)
	L kg (lb)	26.6 (58.6)	26.1 (57.5)
	UL kg (lb)	27.1 (59.8)	26.6 (58.6)
Output	kW (ps)	4C : 2.9 (4) 5C : 3.7 (5) 6C : 4.4 (6)	
Max. Operating Range	rpm	4C & 5C : 4500–5500	6C : 5000–6000
Idle Speed in Forward Gear	rpm	1100	
Idle Speed in Neutral Gear	rpm	1300	
Engine Type		4-Stroke	
Number of Cylinder		1	
Bore × Stroke	mm (in)	59 × 45 (2.32 × 1.77)	
Piston Displacement	mL (Cu in)	123 (7.5)	
Exhaust System		Through hub exhaust	
Cooling System		Water cooling	
Engine Lubrication		Trochoid pump	
Starting System		Manual starter	
Ignition System		Ignitor	
Spark Plug		NGK DCPR6E	
Trim Position		6	
Engine Oil	mL (fl.oz.)	API SF, SG, SH or SJ FCW 10W-30/40, Approx. 450 (15.2)	
Gear Oil	mL (fl.oz.)	Genuine Gear Oil or API GL5, SAE #80-90, Approx. 195	
Fuel		Unleaded regular gasoline : Pump posted 87 Octane (research octane rating of 91)	
Fuel Tank Capacity	L (US gal)	*1.15 (0.30) Integral	12 (3.17) Separate
Gear Reduction Ratio		2.15 (13 : 28)	
Emission Control System		EM (Engine modification)	
Operator Sound Pressure (ICOMIA 39/94) dB (A)		81.6	
Hand Vibration Level (ICOMIA 38/94) m/sec ²		7.2	

*In case of dual fuel tank system, use it together with 12 L separate tank.

Remark: Specifications subject to change without notice.

■ NAMES OF PARTS

ENOM00402-0

4C, 5C, 6C

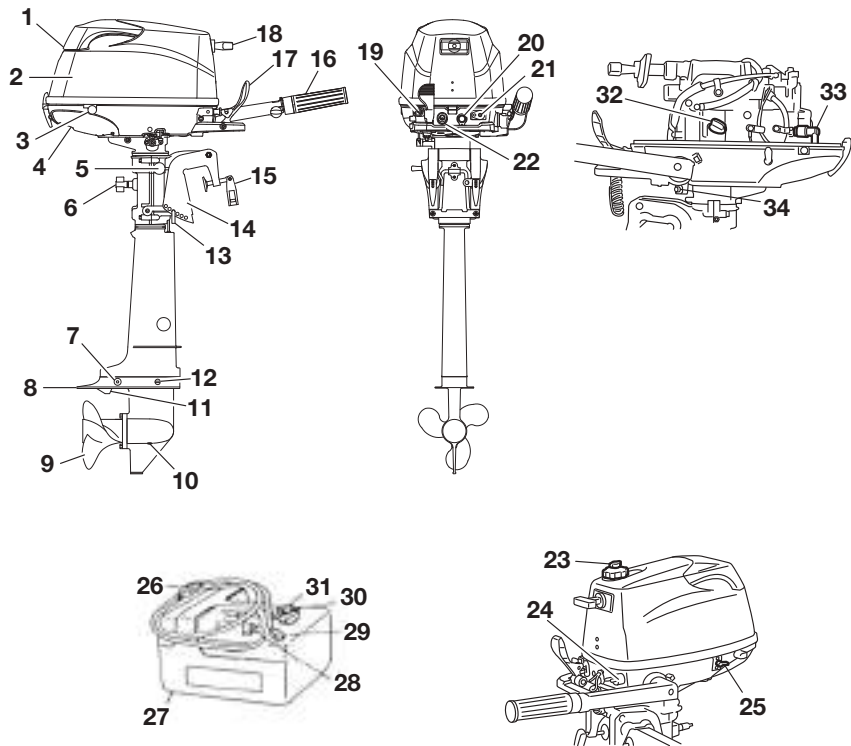

ENOF00401-0

- | | | |
|-----------------------------|-------------------|---------------------------|
| 1 Tilt Handle | 13 Thrust Rod | 25 Fuel Cock |
| 2 Top Cowl | 14 Clamp Bracket | 26 Primer Bulb |
| 3 Bottom Cowl | 15 Clamp Screw | 27 Fuel Tank |
| 4 Cooling Water Check Port | 16 Throttle Grip | 28 Fuel Pick up Elbow |
| 5 Tilt Lever | 17 Shift Lever | 29 Fuel Connector |
| 6 Steering Adjustment Screw | 18 Starter Handle | 30 Air Vent Screw |
| 7 Anode | 19 Choke Knob | 31 Fuel Tank Cap |
| 8 Anti Ventilation Plate | 20 Stop Switch | 32 Engine Oil Cap |
| 9 Propeller | 21 Fuel Connector | 33 Spark Plug |
| 10 Oil Plug (Lower) (Fill) | 22 Warning Lamp | 34 Engine Oil Drain Screw |
| 11 Water Inlet | 23 Air Vent Screw | |
| 12 Oil Plug (Upper) (Level) | 24 Fuel Connector | |

LOCATIONS OF WARNING LABELS

ENOM00403-0

Locations of warning labels

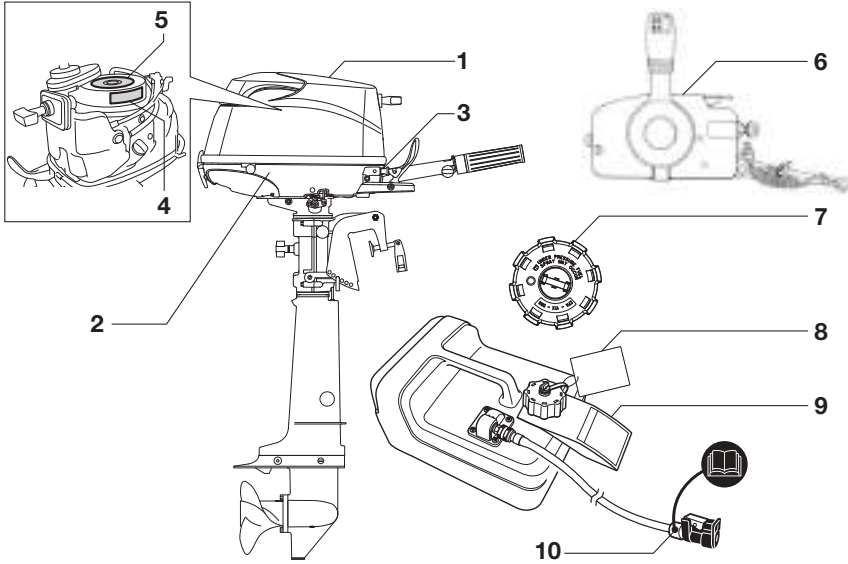

ENOF00402-0

1. Warning label regarding owner's manual, top cowl, engine stop switch, engine oil level and unleaded gasoline.
2. Warning label on position of outboard motor when setting down.

WARNING 警告

- Read owner's manual very carefully before operating this motor. Give special attention to safety cautions.
- Lire très soigneusement le livret d'entretien avant de démarrer ce moteur. Faire très attention aux mesures de sécurité.
- Bedienungsanleitung vor der Inbetriebnahme sorgfältig lesen. Beachten Sie besonders die Sicherheitsvorschriften!
- ご使用前に必ず取扱説明書をお読み下さい。

- Never remove or replace the motor cover while the engine is running.
- Ne jamais déposez ou remettre le capot du moteur quand le moteur tourne.
- Während des Betriebs niemals die Motorhaube entfernen!
- エンジン運転中はモーターカバーを外さないで下さい。

- Be sure to connect the emergency stop line to your wrist.
- Assurez-vous que le cordon de sécurité soit bien attaché à votre poignet.
- Versichern Sie sich, dass die Notstopleine an Ihrem Handgelenk befestigt ist.
- 運転者落水時暴走の危険あり
・運転中はエンジンストップスイッチコードを身体の一部に必ずつけて下さい。

- Check oil level before starting.
- Ölstand vor dem Motorstart überprüfen.
- Vérifier le niveau d'huile avant de démarrer.
- 始動前に必ずエンジンオイル量確認。

- Unleaded fuel only.
- Nur unverbleitetes Benzin verwenden.
- Essence sans plomb uniquement.
- 無鉛ガソリンを使用して下さい。

ENOF00005-0



ENOF00006-0

3. Warning label regarding oil pressure (See page 22).



ENOF00131-0

4. Only for EU model
Warning label regarding emergency starting (See page 29).



ENOF00128-0

5. Warning label regarding rotating parts, electrical shock and high temperature.

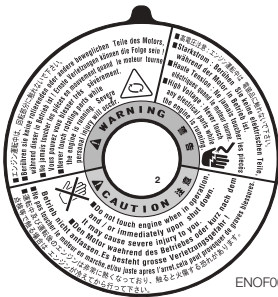

ENOF00129-0

6. Warning label on engine stop switch.



ENOF00008-0

7. Only for USA and CANADA models
Warning regarding fuel tank cap
(See pages 19, 23–28).

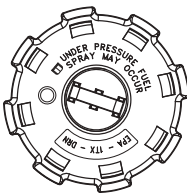

ENOF00012-0

8. Only for USA and CANADA models
Warning regarding combination of fuel tank and primer bulb ass'y.

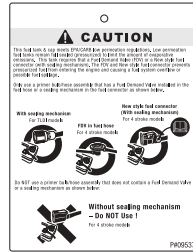

ENOF00010-0

9. Only for USA and CANADA models
When opening or closing fuel tank cap, be sure to observe warning note on fuelling.

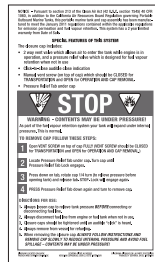

ENOF00011-0

10. Only for USA and CANADA models
Warning regarding fuel connector
(See pages 19, 23–28).

ENOM00023-0

Symbols

Individual symbol marks means as described below.

Warning/ Caution



ENOF000114-0

Read manual thoroughly



ENOF00115-0

Check oil level

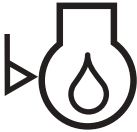

ENOF00116-0

Use unleaded gasoline only



ENOF00117-0

Lay as indicated



ENOF00118-0

Flammable - Keep Fire Away



ENOF00119-0

Gear shift lever operation direction, dual direction



ENOF00122-0

Engine start/Engine cranking



ENOF00123-0

Warning, rotating object



ENOF00249-0

Warning, high voltage



ENOF00204-0

Warning, high temperature



ENOF00205-0

INSTALLATION

ENOM00024-0

1. Mounting the outboard motor on boat

ENOW00006-0

WARNING

Most boats are rated and certified in terms of their maximum allowable horsepower, as shown on the boat's certification plate. Do not equip your boat with an outboard motor that exceeds this limit. If in doubt, contact your dealer.

Do not operate the outboard motor until it has been securely mounted on the boat in accordance with the instructions below.

ENOM00025-0

Position ... Above keel line

Set engine at center of boat.

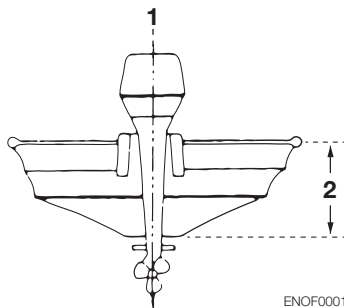

ENOF00014-0

1. Center of boat
2. Boat transom

ENOM00404-0

Transom matching

Be sure that the anti ventilation plate of the outboard motor is below the water surface when running with the throttle wide open. If the above condition cannot be met due to the shape of the bottom of your boat, please consult your authorized dealer.

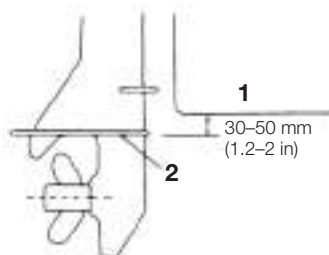

ENOF00410-0

1. Bottom of hull
2. Anti ventilation plate

ENOW00007-0

CAUTION

- Before beginning the running test, check that the boat with maximum capacity loading floats on the water in a proper attitude. Check the position of water surface on the driveshaft housing. If the water surface is near the bottom cowling, in high waves, water may enter the engine cylinders.
- Incorrect outboard motor mounting height or existence of underwater object(s), such as hull bottom design, bottom surface conditions or underwater accessories, can cause water spray possibly reaching the engine through an opening of the bottom cowling during cruising. Exposing the engine to such conditions for extended periods can lead to severe engine damage.

1. To attach the outboard motor to the boat, tighten the clamp screws by turning their handles.

Secure the outboard motor with a rope to prevent loss overboard.

ENON00002-0

Note

A rope is not included in the standard accessories.



ENOF00411-0

1. Option

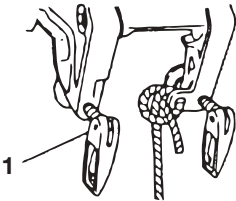

ENOF00412-0

1. Clamp screw

ENON00401-0

Note

It is recommended to install upper mounting bolts with bolt head at inside surface of transom. Bolts with threaded end at inside surface of transom can cause personal injury.

ENOW00009-0

! WARNING

- Mounting the outboard motor without following this manual can lead to unsafe conditions such as poor maneuverability, lack of control or fire.
- Loose clamp screws and/or mounting bolts can lead to the release or displacement of the outboard motor, possibly resulting in lost of control and/or serious personal injury. Be sure that fasteners are tightened to the specified torque (30 Nm (3.0 kgf) 13 ft-lb). Check the fasteners for tightness from time to time.

- Be sure to use outboard mounting fasteners included in the outboard motor package or their equivalents in terms of size, material, quality and strength. Tighten fasteners to the specified torque (30 Nm (3.0 kgf) 13 ft-lb). Test cruise to check if fasteners are tightened securely.
- Outboard motor mounting must be performed by trained service person(s) using lift or hoist with sufficient capacity.

ENOM00405-0

2. Installing the remote control devices

It is recommended that you consult with your authorized dealer for installation and adjustment of the remote control device.

ENOW00010-0

! WARNING

When using other than Nissan Marine's genuine remote control box, **DO NOT** select the one without neutral safety switch that prevents in-gear start. Use of remote control box without neutral safety switch can allow start of engine with gear at other than neutral shift, potentially leading passengers to falling or causing passenger to be thrown overboard.

PRE-OPERATING PREPARATIONS

ENOM00016-0

DANGER

Consult an authorized dealer for details on handling gasoline, if necessary.

Gasoline and its vapors are very flammable and can be explosive.

When carrying a fuel tank containing gasoline:

- Close the air vent screw of fuel tank cap, or gasoline vapor will be emitted through the air vent screw, creating a fire hazard.
- Do not smoke.

When or before refueling:

- Stop the engine, and do not start the engine during refueling.
- Do not smoke.
- Be careful not to overfill fuel tank. Wipe up any spilled gasoline immediately.

When or before cleaning the gasoline tank:

- Dismount fuel tank from the boat.
- Place the fuel tank away from every source of ignition, such as sparks or open flames.
- Do the work outdoors or in a well ventilated area.
- Wipe off gasoline well immediately if spilt.

After cleaning gasoline tank:

- Wipe off gasoline well immediately if spilt.
- If the fuel tank is disassembled for cleaning, reassemble carefully. Imperfect assembly may cause a fuel leak, possibly leading to fire or explosion.
- Dispose aged or contaminated gasoline in accordance with local regulations.

ENOM00030-0

1. Recommended gasoline types

ENOM00017-0

CAUTION

Use of improper gasoline can damage your engine. Engine damage resulting from the use of improper gasoline is considered misuse of the engine, and damage caused thereby will not be covered under the limited warranty.

ENOM00031-0

FUEL RATING

NISSAN MARINE engines will operate satisfactorily when using a major brand of unleaded gasoline meeting the following specifications:

USA and Canada — having a posted pump Octane Rating of 87 (R+M)/2 minimum. Premium gasoline (92 [R+M]/2 Octane) is also acceptable. Do not use leaded gasoline.

Outside USA and Canada — Use unleaded gasoline with declared octane rating of 90 RON or over. Use of premium gasoline of 98 RON is also allowed. Use of name-brand leaded gasoline may be allowed only if unleaded gasoline is not available.

ENOM00406-0

GASOLINES CONTAINING ALCOHOL

The fuel system components on your NISSAN MARINE engine will withstand up to 10% alcohol content in the gasoline. But if the gasoline in your area contains either methanol (methyl alcohol) or ethanol (ethyl alcohol), you should be aware of certain

adverse effects that can occur. These adverse effects are more severe with methanol. Increasing the percentage of alcohol in the fuel can also worsen these adverse effects. Some of these adverse effects are caused because the alcohol in the gasoline can absorb moisture from the air, resulting in a separation of the water/alcohol from the gasoline in the fuel tank.

These may cause increased:

- Corrosion of metal parts
- Deterioration of rubber or plastic parts
- Fuel permeation through rubber fuel lines
- Starting and operating difficulties

ENOW00018-0

 **WARNING**

Fuel leakage can cause fire or explosion, potentially leading to severe injury or loss of life. Every fuel system part should be checked periodically, and especially after long term storage, for fuel leak, change of hardness of rubber, expansion and/or corrosion of metals. In case any indication of fuel leakage or degradation of fuel part is found, replace relevant part immediately before continuing operation.

If the use of gasoline containing alcohol is inevitable, or presence of alcohol is suspected in the gasoline, it is recommended to add a filter that has water separating capability, and check the fuel system for leaks and mechanical parts for corrosion and abnormal wear more frequently.

And, in case any of such abnormality is found, discontinue the use of such gasoline and contact our dealer immediately.

Damages resulting from the use of gasolines that contain alcohol are not covered under the limited warranty.

Fuel tank capacity:

12 liters (3.17 U.S. gal)

Fuel Tank: When using a fixed fuel tank in place of genuine fuel tank, it is recommended to select a one with a structure facilitating interior cleaning.

ENOW00019-0

 **WARNING**

Do not fill the fuel tank over capacity. The rise of gasoline temperature may cause gasoline to expand which, if overfilled, may leak through air vent screw when it is open. Leaking gasoline is a dangerous fire hazard.

ENOW00020-0

 **CAUTION**

When operating a NISSAN MARINE engine on gasoline containing alcohol, storage of gasoline in the fuel tank for long periods should be avoided. Long periods of storage, common to boats, create unique problems. In cars, alcohol blend fuels normally are consumed before they can absorb enough moisture to cause trouble, but boats often sit idle long enough for phase separation to take place. In addition, internal corrosion may take place during storage if alcohol has washed protective oil films from internal components.

ENOM00033-0

2. Low permeation fuel hose requirement

EQUIPPED FOR UNITED STATES AND CANADA MODEL

Required for outboards manufactured for sale, sold, or offered for sale in the United States

- NISSAN MARINE engine has used fuel hoses for The Environmental Protection Agency (EPA) requires from January 1, 2011.

ENOM00407-0

3. EPA pressurized fuel tank requirements

EQUIPPED FOR UNITED STATES AND CANADA MODEL

The Environmental Protection Agency (EPA) required portable fuel tank (after January 1, 2011) for use with outboard engines to remain fully sealed (pressurized) up to 34.4 kPa (5.0 psi). And integral fuel tank (after August 1, 2011) is also required to remain fully sealed up to 7 kPa (1.0 psi). These tanks may contain the following:

- An air inlet that opens to allow air to enter as the fuel is drawn out of the tank.
- An air outlet that opens (vents) to the atmosphere if pressure exceeds 34.4 kPa (5.0 psi) or 7 kPa (1.0 psi). A hissing noise may be heard as the tank vents to the atmosphere. This is normal.
- When installing the fuel tank cap, turn the cap to the right until you hear two clicks. This signals that the fuel cap is fully seated. A built-in device prevents overtightening.
- The fuel tank has a manual vent screw which should be closed for transportation and full open for operation and cap removal.

Since sealed fuel tanks are not openly vented, they will expand and contract as the fuel expands and contracts during

heating and cooling cycles of the outside air. This is normal.

*Please refer to See pages 23–28 when using this fuel tank.

ENOM00408-0

4. EPA approval Primer valve/hose assembly

EQUIPPED FOR UNITED STATES AND CANADA MODEL

NISSAN MARINE adopts Primer bulb/hose assembly approved by the Environment Protection Agency (EPA).

Please use the EPA approved primer bulb/hose assembly with the identification mark on the fuel connector.



ENOF00413-0

ENOW00021-0

CAUTION

Be sure to use EPA approved tank and EPA approved primer bulb/hose assembly as a set. Confirm shapes of EPA approved tank and regular tank.

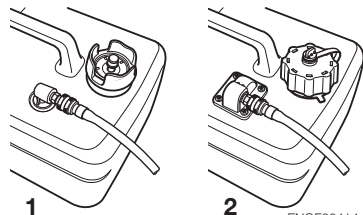

ENOF00414-0

1. Except for U.S. model (regular tank)
2. For U.S. and Canada model (EPA approved tank)

ENOM00037-0

5. Recommended engine oil

Use only high quality 4-stroke engine oil to insure performance and prolonged engine life.

Use NMMA FC-W certified 4-stroke engine oil below.

10W-30: is recommended for use in all temperature.

25W-40: may be used at temperatures above 4°C (40°F).

You can also use oils that carry the API rating of SF, SG, SH, SJ, SL, or SM. Select the appropriate viscosity, based on atmospheric temperature, from the chart below.

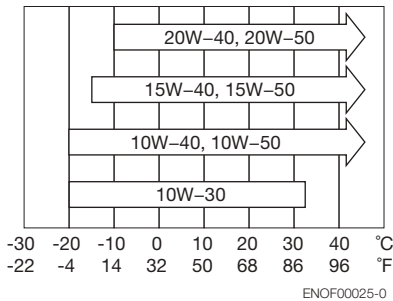

ENOW00022-0

CAUTION

The engine oil is drained for shipping from the factory. Be sure to fill the engine to the proper level before starting engine. (To properly fill the engine with oil follow the instructions in section 10 of this manual)

ENON00007-0

Note

Use of engine oils that do not meet these requirements will result in reduced engine life, and other engine problems.

ENOM00440-0

6. Altitude adjustment kit requirement

For U.S.A. market only

High altitude:

When engine operates at high altitude engine may need to have a high altitude kit installed. Otherwise, operating the engine at high altitude may increase its emissions and decrease fuel efficiency and performance. Please see "LIMITED WARRANTY INFORMATION" for more detail.

ENOM00038-0

7. Break-In

Your new outboard motor and lower unit require break-in for the moving components according to the conditions described in the following time table.

ENOW00023-0



Operating the outboard motor without break-in can shorten service life of the product.

If any abnormality is experienced during the break-in:

- **Discontinue the operation immediately.**
- **Have the dealer check the product and take proper action(s) if necessary.**

	1-10 min	10 min - 2 hrs	2-3 hrs	3-10 hrs	After 10 hrs
Throttle Position	Idle	Less than 1/2 throttle	Less than 3/4 throttle	3/4 throttle	Full throttle available
Speed		Approx. 3000 rpm max	Full throttle run allowed for 1 min every 10 min	Approx. 4000 rpm. Full throttle run allowed for 2 min every 10 min	

ENON00008-0

Note

Proper break-in allows outboard motor to deliver it full performance for longer service life.

ENOW00024-0



Do not operate the outboard motor in closed area or area with no forced ventilation.

Exhaust gas emitted by this outboard motor contains carbon monoxide that will cause death if inhaled continuously. Inhaling the gas initially causes symptoms such as feeling of sickness, drowsiness and headache.

During operation of the outboard motor:

- **Keep peripheral area well ventilated.**
- **Always attempt to stay on the windward side of emission.**

ENOM00409-0

8. Engine oil warning lamp

Oil pressure is required to lubricate internal engine parts.

When the warning lamp (Red) is off, it indicates that oil pressure is present.

Remark: When engine is first started, the red light will turn on for several seconds to confirm that it is working and then turn off.

ENOW00402-0



Never run the engine if the warning lamp is on or blinking on and off.

When the warning lamp is on or blinking on and off, as an additional alert of the low oil pressure condition.

*Stop the engine immediately and check the engine oil level.

If the oil level is lower than the appropriate level: Replenish engine oil.

If the oil level is within the appropriate level: Consult with your dealer.

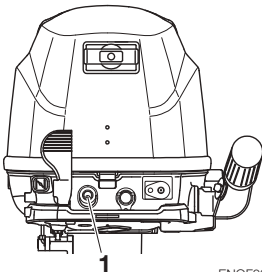

ENOF00415-0

1. Warning Lamp

ENOM00410-0

9. ESG (A device preventing over revolution)

ESG is a device to prevent over revolution of the engine (more than approximately 6250 rpm).

If you sense that the ESG is activated return to shore at a reduced speed (rpm). Possible causes of ESG activation are: Worn, broken, bent propeller. Slipping propeller rubber, Making sharp turns at high speeds.

ENON00202-0

Note

If the engine speed drops frequently after restarting the engine, please contact your dealer.

ENGINE OPERATION

ENOM00042-0

Before starting

ENOW00022-0

CAUTION

The engine oil is drained for shipping from the factory. Be sure to fill the engine to the proper level before starting engine. (To properly fill the engine with oil follow the instructions in section 10 of this manual)

ENOW00027-0

CAUTION

Before starting engine for the first time after reassembling engine or off-season storage, disconnect stop switch lock and pull the starter handle completely out approximately 10 times in order to prime the oil pump.

ENOM00411-0

1. Filling the fuel

ENOW00028-0

DANGER

Consult an authorized dealer for details on handling gasoline, if necessary. Gasoline and its vapors are very flammable and can be explosive.

When carrying a fuel tank containing gasoline:

- Close the fuel tank cap and air vent screw of fuel tank cap, or gasoline vapor will be emitted through the air vent screw, creating a fire hazard.
- Do not smoke.

When or before refueling:

- Stop the engine, and do not start the engine during refueling.
- Do not smoke.
- Be careful not to overfill fuel tank. Wipe up any spilled gasoline immediately.

When or before cleaning the gasoline tank:

- Dismount fuel tank from the boat.
- Place the fuel tank away from every source of ignition, such as sparks or open flames.
- Do the work outdoors or in a well ventilated area.
- Wipe off gasoline well immediately if spilt.

After cleaning gasoline tank:

- Wipe off gasoline well immediately if spilt.
- If the fuel tank is disassembled for cleaning, reassemble carefully. Imperfect assembly may cause a fuel leak, possibly leading to fire or explosion.
- Dispose aged or contaminated gasoline in accordance with local regulations.

ENOW00029-0

! WARNING

When opening fuel tank cap, be sure to follow the procedure described below. Fuel could blast out through the fuel tank cap in case the cap is loosened by using another procedure when internal pressure of fuel tank is raised by heat from sources such as engine or sun light.

Except for USA and Canada model

1. When using integral tank

Before opening fuel tank cap, turn air vent screw two times counterclockwise to release air pressure in the fuel tank.

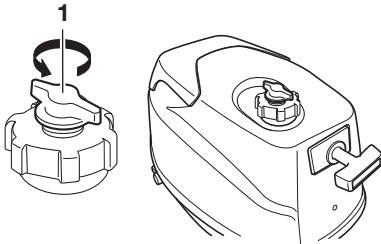

ENOF00416-0

1. Two turns the air vent screw

When using separate tank

Full open the air vent screw on the tank cap and release internal pressure.

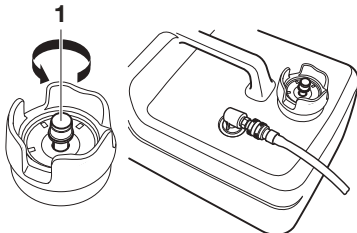

ENOF00417-0

1. Full open the air vent screw
2. Open the fuel tank cap slowly.
3. **When using integral tank**
Remove top cowl and fill the fuel not to over the full mark.

When using separate tank

Fill the fuel carefully not to over flow.

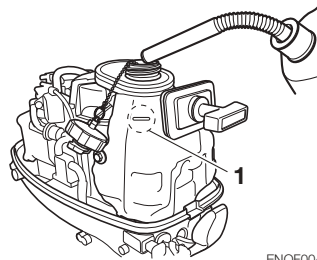

ENOF00418-0

1. Full mark

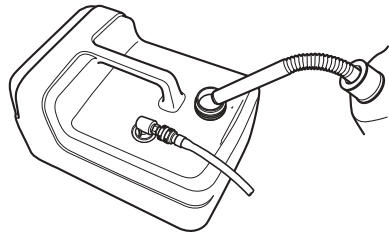

ENOF00419-0

4. After filling the tank, close the tank cap.

For USA and Canada model

1. Full open the air vent screw on the tank cap and release internal pressure.

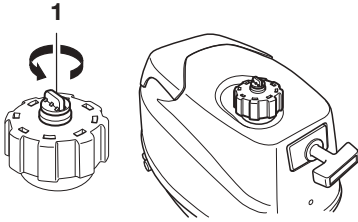

ENOF00420-0

1. Full open air vent screw

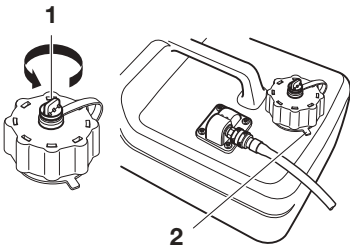

ENOF00421-0

1. Full open air vent screw
2. Tab lock

2. When using integral tank

Open the fuel tank cap slowly.

When using separate tank

Loosen the tank cap until it contacts the tab lock and release internal pressure completely. After that, press down the tab lock and open the tank cap.

3. When using integral tank

Remove top cowl and fill the fuel not to over the full mark.

When using separate tank

Fill the fuel carefully not to over flow.

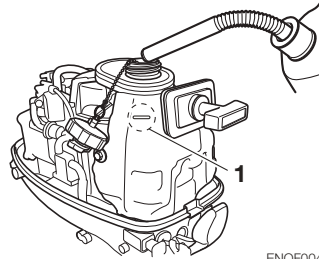

ENOF00418-0

1. Full mark

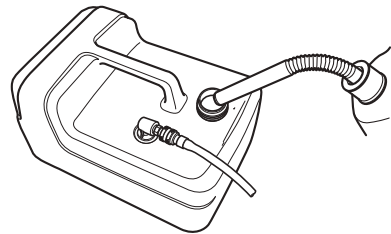

ENOF00419-0

4. After filling the tank, close the tank cap until two clicks sound is heard.

ENOM00412-0

2. Feeding the fuel

Except for USA and Canada model

1. When using integral tank

Loosen the air vent screw on the tank cap by two turns.

When using separate tank

Full open the air vent screw on the tank cap.

ENOW00403-0

CAUTION

When separate tank is used for dual tank model, be sure to open air vent of integral tank as well as air vent of separate tank. If air vent of integral tank that contains fuel is closed, swelling of air in the tank by heat from engine can cause increase of internal pressure of the tank dangerously.

2. Open the fuel tank cap slowly and release internal pressure completely.
3. Set fuel cock lever to which you would like to use.

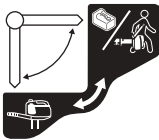

ENOF00422-0

ENOW00404-0

CAUTION

When using integral tank, disconnect fuel connector.

4. If you use a separate tank, connect the fuel connector to the engine and squeeze primer bulb until it becomes stiff to feed fuel to carburetor. Direct arrow mark upward when priming.

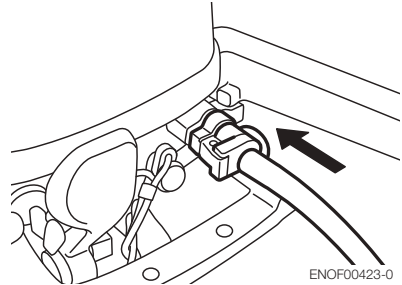

ENOF00423-0

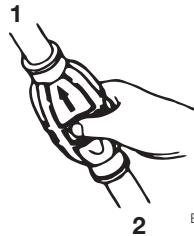

ENOF00032-0

1. Engine side
2. Fuel tank side

Do not squeeze primer bulb while engine running or when the outboard motor is tilted up. Otherwise, fuel could overflow.

For USA and Canada model

1. Full open the air vent screw on the tank cap.

ENOW00405-0

CAUTION

When separate tank is used for dual tank model, be sure to open air vent of integral tank as well as air vent of separate tank. If air vent of integral tank that contains fuel is closed, swelling of air in the tank by heat

from engine can cause increase of internal pressure of the tank dangerously.

2. When using integral tank

Open the fuel tank cap slowly and release internal pressure completely. After that, close the fuel tank cap.

When using separate tank

Loosen the tank cap until contacts the tab lock and release internal pressure completely. After that, close the fuel tank cap.

3. Set fuel cock lever to which you would like to use.

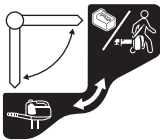

ENOF00425-0

ENOW00406-0

CAUTION

When using integral tank, disconnect fuel connector.

4. If you use a separate tank, connect the fuel connector to the engine and squeeze primer bulb until it becomes stiff to feed fuel to carburetor. Direct arrow mark upward when priming.

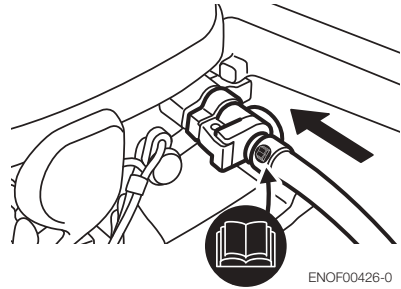

ENOF00426-0



ENOF00032-0

1. Engine side
2. Fuel tank side

Do not squeeze primer bulb while engine running or when the outboard motor is tilted up. Otherwise, fuel could overflow.

ENOW00030-0

CAUTION

When using EPA approval fuel tank, only use a primer bulb/hose assembly that has a Fuel Demand Valve installed in the fuel hose or a sealing mechanism in the fuel connector as shown below.

(FDV and fuel connector that has an sealing mechanism prevent pressurized fuel from entering the engine and causing a fuel system overflow or possible fuel spillage.)

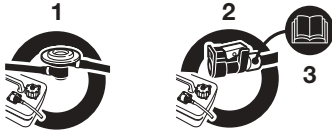

ENOF00035-0

1. FDV in fuel hose
2. Sealing mechanism in fuel connector
3. Identification

Do NOT use a primer bulb/hose assembly that does not contain a Fuel Demand Valve or a sealing mechanism as shown below: otherwise overflow the fuel system or fuel spillage may occur.



ENOF00036-0

ENOM00413-0

3. Starting

1. Place the shift lever in the neutral position.

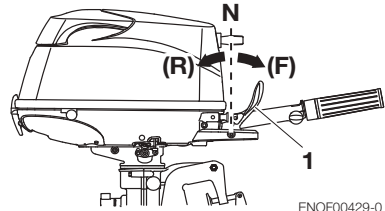

ENOF00429-0

1. Shift lever
2. Attach the stop switch tether to a secure place on your arm or clothing. And then, install the lock plate into the engine stop switch.

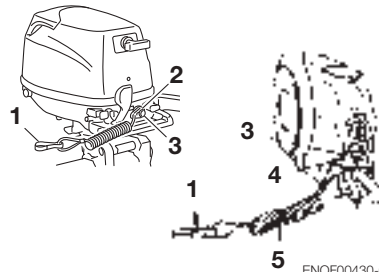

ENOF00430-0

1. Hook
2. Stop switch lock
3. Stop switch
4. Lock
5. Lanyard cord

ENOW00201-0

⚠ WARNING

Accidental activation of the Emergency Stop Switch (such as the tether being pulled out in heavy seas) could cause passengers to lose their balance and even fall overboard, or it could result in loss of power in heavy seas, strong currents, or

high winds. Loss of control while mooring is another potential hazard.

To minimize accidental activation of the Emergency Stop Switch, the 500 mm (20 inch.) stop switch tether is coiled and can extended to a full 1300 mm (51 inch.).

3. Set the throttle grip to slow position.

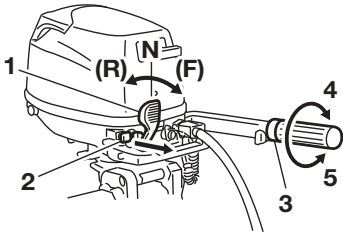

ENOF00431-0

1. Shift lever
2. Choke knob
3. Throttle grip
4. SLOW
5. HIGH

4. Pull the choke knob out. (Pulling the choke knob is not necessary when the engine is warm. If the engine is warm, open the throttle grip until the triangular mark.)

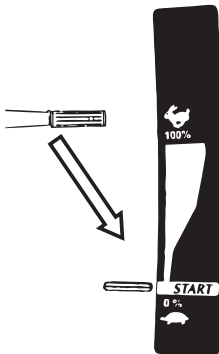

ENOF00039-0

5. Gently pull the starter handle until you feel slight resistance (engagement) and strongly pull the handle without a rest.

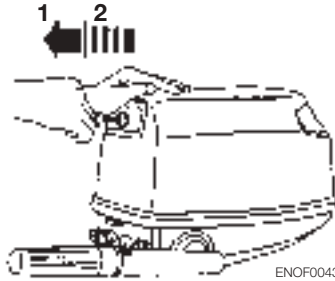

ENOF00432-0

1. Quickly
2. Slowly

6. When the motor starts, push the choke knob back. (in the case the choke knob is used.)

ENON00203-0

Note

When warming up the engine in cold weather, set the choke knob to half opened position if necessary.

ENON00204-0

Note

In-gear starting of engine will move the boat immediately, potentially leading to falling down or causing passenger(s) to be thrown overboard.

ENOM00414-0

If the recoil starter fails to operate

1. Remove the top cowl.
2. Disconnect the rink of the starter lock rod.

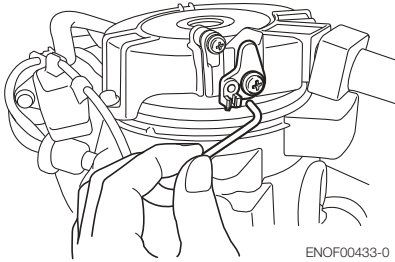

3. Remove the bolts (5pcs) and remove the recoil starter.

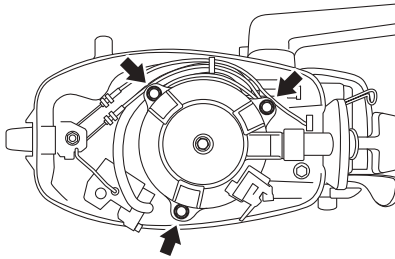

4. Insert the knotted end of the starter rope into the notch in the flywheel and wind the rope around the flywheel several turns clockwise.

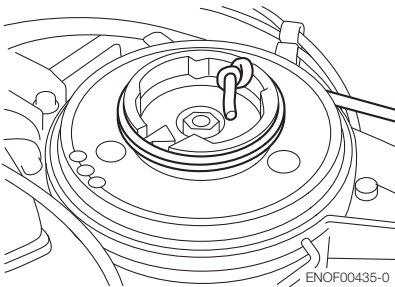

5. Tie a loop in the another end of the emergency starter rope and attach socket wrench that is included in the tool kit.

6. Confirm that the shift lever is at neutral position.
7. Pull the choke knob out when the engine is cold.
8. Pull the starter handle slowly until you feel engagement, keep pulling till you feel less resistance. Then pull it quickly.

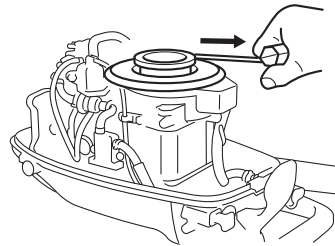

ENOW00099-0

! WARNING

When the emergency starter rope is used for starting engine;

- **Start in gear protection does not work. Be sure to shift is at neutral position. Otherwise the engine will move the boat immediately and cause personal injury.**
- **Be careful that your clothes or other items do not get caught in the rotating engine parts.**
- **To prevent accident and injury by rotating parts, do not re-attach the recoil starter after the engine has been started.**
- **Do not pull starter rope if any bystander is behind. The action can injure the bystander.**
- **Attach engine stop switch lanyard to clothing or any part of body like arm before starting engine.**
- **Be careful not to remove engine stop switch lanyard from engine accidentally while boat is running. Sudden stop of engine can cause loss of steering control. It can also cause loss of boat speed, possibly leading the crew(s) and or**

objects on the boat to be thrown forward due to inertial force.

- Do not touch electrical components such as ignition coils, spark plug cables or spark plug caps when starting engine or while engine is in operation. Touching any of these parts can cause electrical shock.

ENOM00043-0

4. Warming up the engine

Warm the engine at low engine speeds for about three minutes. This allows the lubricating oil to circulate to all parts of the engine. Operating the engine without warm up shortens the engine's life.

Be sure to check that cooling water is coming out of the cooling water check port during warm up.

ENOW00035-0

! CAUTION

If the engine is operated without water discharging from the check port, the engine may over heat.

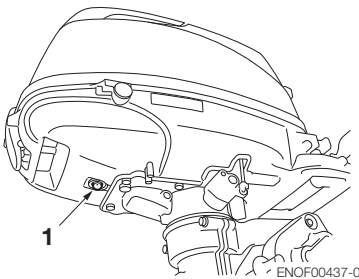

1. Cooling water check port

ENOW00036-0

! CAUTION

Be sure to stop engine immediately if cooling water check port is not discharging water, and check if cooling water intake is blocked. Operating engine could lead to overheating potentially leading to engine damage. Consult an authorized dealer if the cause cannot be found.

ENOM00415-0

Engine speeds

Idling speed after warming up.

Remark: In case of cold engine starting, idling speed is increased about 300 rpm for several minutes.

Clutch in (In gear)	Clutch off (Out of gear)
1100 rpm	1300 rpm

ENOM00416-0

Propeller selection

Propeller must be selected that will allow the engine to reach recommended rpm when cruising at wide-open throttle.

Wide-open throttle rpm range	
4, 5	6
4500–5500 rpm	5000–6000 rpm

Genuine propellers are listed on PROPELLER TABLE of this manual.

ENOM00046-0

5. Forward and reverse

ENOW00037-0

! WARNING

Before shifting into forward or reverse, make sure that boat is properly moored and outboard motor can be steered fully to

the right and left. Make sure that no swimmer(s) is ahead or astern of the boat.

ENOW00038-0

WARNING

- Attach other end of emergency stop switch tether to the operator's clothing or arm and keep it attached during cruising.
- Do not attach the tether to a part of clothing that can be torn easily when pulled.
- Arrange the tether so that will not be caught by any object when pulled.
- Be careful not to pull the tether accidentally during cruising. Unintentional stop of engine can cause loss of control of outboard motor. Rapid loss of engine power can lead to falling down or causing passenger(s) to be thrown overboard.

ENON00012-0

Note

Do not increase engine speed unnecessarily in reverse.

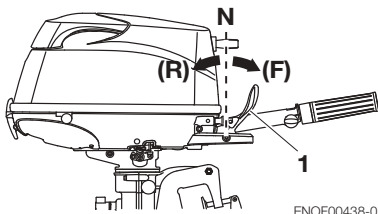

ENOF00438-0

1. Shift lever

ENOW00039-0

WARNING

Severe damage, and personal injury, may occur if shifting at high engine speed. Engine must be in the slow idle position before shifting is attempted.

ENOM00417-0

Forward

Turn the throttle grip to reduce engine speed. When the engine reaches trolling (or idling) speed, quickly pull the shift lever to the Forward position.

ENOM00418-0

Reverse

Reduce engine speed, when the engine reaches trolling (or idling) speed, quickly push the shift lever to the Reverse position.

ENOW00040-0

WARNING

Before shifting, make sure that no swimmer(s) or obstacle(s) is ahead or astern of the boat.

ENOW00041-0

CAUTION

Be sure to warm up engine well before starting cruise. Operating cold engine may cause damage to your motor.

ENON00013-0

Note

Idle speed may be higher during warming up of engine. If shifted to Forward or Reverse during warming up, it may be difficult to shift back to neutral. In such case, stop engine, shift to neutral, and restart engine to warm up.

ENON00014-0

Note

Frequent shifting to forward or reverse can accelerate wear or degradation of parts. In such case, replace gear oil earlier than the period specified.

ENOM00419-0

6. Stopping

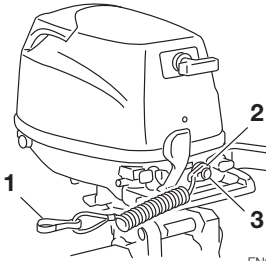

ENOF00439-0

1. Hock
2. Stop switch lock
3. Stop switch

1. Turn the throttle grip to the slow position.
2. Put the shift lever in the Neutral position.
Run the engine for 2-3 minutes at idling speed if it has been running at full speed.
3. Push the stop switch to stop the engine or release the stop switch lock.

ENOW00042-0

⚠ WARNING

- Do not shift into Reverse during planing, or control will be lost leading to serious personal injury, boat may swamp, and/or hull may be damaged.
- Do not shift into Reverse during cruising, or control may be lost, falling down or causing passenger(s) to be thrown overboard. Leading to serious personal injury, and steering system and/or shifting mechanism may be damaged.

ENOM00402-0

Notes

- After stopping the engine, close the air vent screw on the tank cap.
- Disconnect the fuel connector of the engine or the fuel tank.

ENOM00050-0

7. Trim angle

The trim angle of the outboard motor can be adjusted to suit the transom angle of the hull, and load conditions. Choose an appropriate trim angle that will allow the anti-ventilation plate to run parallel to the water surface during operation.

ENOM00420-0

Proper trim angle

The position of the thrust rod (or preset knob) is correct if the hull is horizontal during operation.

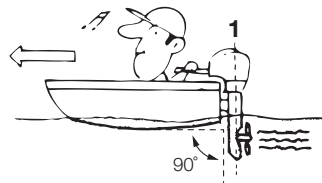

ENOF00051-0

1. Perpendicular to the water surface

ENOM00421-0

Improper trim angle

Set the thrust rod (or preset knob) lower if the bow of the boat rises above horizontal.



ENOF00052-0

Remark: Thrust rod is for MF and EF, and preset knob is for EP.

ENOW00043-0

WARNING

- Do not put hand or finger in between outboard motor body and clamp bracket when adjusting trim angle to prevent injury in case the outboard motor body falls.
- Unsuitable trim position can cause loss of control of boat.
When testing a trim position, run boat slow initially to see if it can be controlled safely.

ENOW00204-0

WARNING

Excessive trim up or down may lead to unstable boat operation, potentially causing the steering difficulty that leads to accident during cruising.

- Do not cruise at high speed if improper trim position is suspected. Stop the boat and readjust trim angle before continuing cruise.

ENOM00422-0

Improper trim angle

Set the thrust rod (or preset knob) higher if the bow of the boat is below horizontal.



ENOF00053-0

1. Stop the engine.
2. Shift the outboard into neutral.
3. Raise the engine to the tilt up position.
4. Change the thrust rod position.
5. Gently lower the outboard.

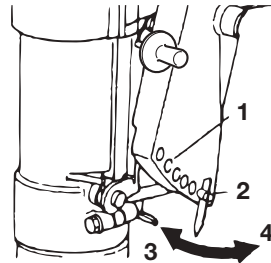

ENOF00440-0

1. Trim angle adjustment hole
2. Thrust rod
3. Higher
4. Lower

ENOW00043-0

WARNING

- Do not put hand or finger in between outboard motor body and clamp bracket when adjusting trim angle to prevent injury in case the outboard motor body falls.
- Unsuitable trim position can cause loss of control of boat.
When testing a trim position, run boat slow initially to see if it can be controlled safely.

ENOW00204-0

⚠ WARNING

Excessive trim up or down may lead to unstable boat operation, potentially causing the steering difficulty that leads to accident during cruising.

- Do not cruise at high speed if improper trim position is suspected. Stop the boat and readjust trim angle before continuing cruise.

ENON00403-0

Note

Stop the engine before adjusting trim angle.

ENOM00060-0

8. Tilt up, tilt down and shallow water operation

ENOW00048-0

⚠ WARNING

When tilting up or down, be careful not to place your hand between the swivel bracket and the stern bracket. Be sure to tilt the outboard motor down slowly.

ENON00018-0

Note

Stop the engine before tilting up.

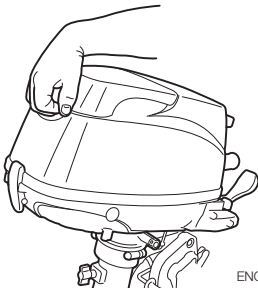

ENOF00441-0

ENOM00423-0

Tilt up

With the shift lever in Forward, fully tilt the motor up toward you by holding the tilt handle provided at the rear of the top cowl. Then slightly lower the motor for locking in the up position.

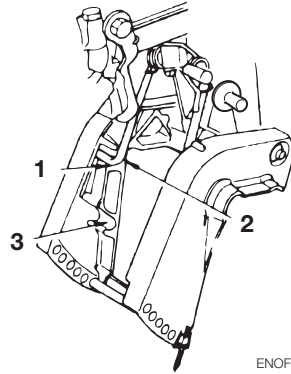

ENOF00442-0

1. Tilt up position
2. Tilt stopper
3. Shallow water running position

ENOM00424-0

Tilt down

Slightly tilt the motor up, and pull the tilt lever toward you to release the tilt-lock. Then lower the motor slowly.

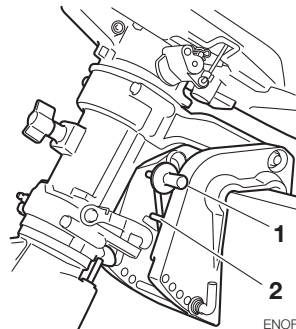

ENOF00443-0

1. Tilt lever
2. Tilt stopper

ENOW00049-0

WARNING

- Do not put hand or finger in between outboard motor body and clamp bracket when adjusting trim angle to prevent injury in case the outboard motor body falls.
- When tilting up outboard motor with fuel joint for over a few minutes, be sure to disconnect fuel hose or close fuel cock, or fuel may leak, potentially catching fire.

ENOW00050-0

CAUTION

Do not tilt up outboard motor during operation, or engine may be damaged from overheating due to lack of sufficient cooling water.

ENOM00425-0

9. Shallow water operation

ENOW00051-0

WARNING

During shallow water operation, be careful not to place your hand between the swivel bracket and the stern bracket.

Be sure to tilt the outboard motor down slowly.

ENON00019-0

Note

Slow down to trolling speed, and shift into neutral before setting outboard motor to shallow water drive position.

ENOW00052-0

WARNING

- Run at lowest possible speed when using shallow water drive.

- Tilt lock is disabled when in shallow water drive position.
- When driving shallow water, be careful not to strike outboard motor against sea bottom, or propeller may be pushed out of water, resulting in loss of control.

ENOW00053-0

CAUTION

While in shallow water drive position, do not operate the outboard motor in Reverse. Operate the outboard motor at slow speed and keep the cooling water intake submerged.

ENOM00426-0

Shallow water running position

With the shift lever in Forward, tilt the motor up slowly, to approximately 40°, then lower the motor it will automatically set in the shallow water operation angle.

ENOM00427-0

Tilt down from shallow water running position

Tilt the motor up, approximately 15°, and pull the tilt lever toward you then lower the motor slowly to the normal running position.

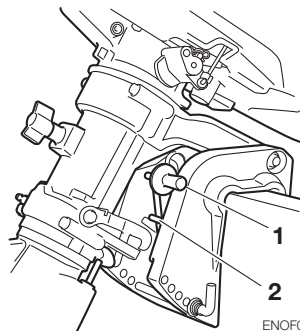

ENOF00443-0

1. Tilt lever
2. Tilt stopper

ENOW00055-0

**WARNING**

Do not tilt up or down outboard motor when swimmer(s) or passenger is near to prevent them from being caught between outboard motor body and clamp bracket in case the outboard motor body falls.

ENOW00056-0

**WARNING**

When tilting up outboard motor with fuel joint for over a few minutes, be sure to disconnect fuel hose or close fuel cock, or fuel may leak, potentially catching fire.

ENOW00057-0

**CAUTION**

Do not tilt up outboard motor while engine operates, or no cooling water may be fed, leading to engine seizure due to overheating.

REMOVING AND CARRYING THE OUTBOARD MOTOR

ENOM00070-0

1. Removing the outboard motor

1. Stop the engine.
2. Disconnect the fuel connector, the remote control cables and the battery cords from the outboard motor.
3. Remove the outboard motor from boat and completely drain the water from the gear case.

ENOW00064-0

CAUTION

Engine may be hot immediately after operating and could cause burns if touched. Allow engine to cool down before attempting to carry the outboard.

ENOM00071-0

2. Carrying the outboard motor

Keep the outboard motor in a vertical position when carrying.

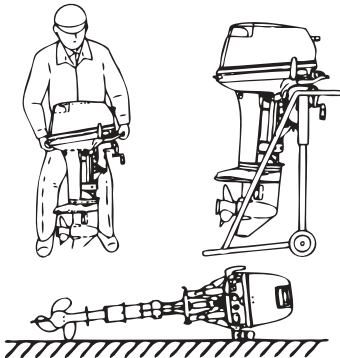

ENOF00071-0

ENOW00065-0

WARNING

- Close air vent screw of fuel tank and fuel cock before carrying or storing outboard motor and fuel tank, or fuel may leak, potentially catching fire.
- Do not give a shock to an outboard motor during transportation. It becomes a cause of breakage.

ENOM00072-0

3. Storing the outboard motor

Outboard motor should be stored in a vertical position.

ENON00021-0

Note

If the outboard motor must be laid down be sure the tiller handle faces down as shown in the drawing above.

Elevate power unit 2 inches to 4 inches if traveling to avoid oil spillage.

ENOW00066-0

CAUTION

Do not carry or store outboard motor in any of positions described below. Otherwise, engine damage or property damage could result from leaking oil.

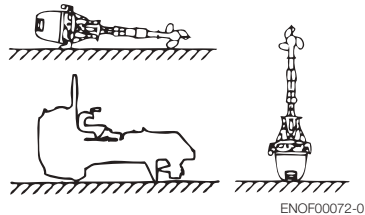

ENOF00072-0

TRAILERING

ENOW00067-0

⚠ WARNING

Do not go under outboard motor tilted up even if it is supported by support bar, or accidental fall of outboard motor could lead to severe personal injury.

ENOW00068-0

⚠ WARNING

Close air vent screw of fuel tank and fuel cock before carrying or storing outboard motor and fuel tank, or fuel may leak, potentially catching fire.

ENOW00069-0

⚠ WARNING

When taking outboard motor from package or removing outboard motor from the boat, never release the lock lever. If the lock lever is released, it will very easy for the clamp bracket to spring up to the tilting direction because it is not fixed.

ENOW00071-0

⚠ CAUTION

The tilt support device supplied on your outboard motor is not intended for towing. It is intended to support the outboard motor while the boat is docked, beached, etc.

ENOW00072-0

⚠ CAUTION

When trailering the outboard motor should be in a vertical (normal running) position, fully down. Trailering in the tilted position may cause damage to the outboard motor, boat, etc.

If trailering with outboard motor fully down is not available (the gear case skeg is too close to the road in a vertical position), fix the outboard motor securely using a device

(like a transom saver bar) in the tilted position.

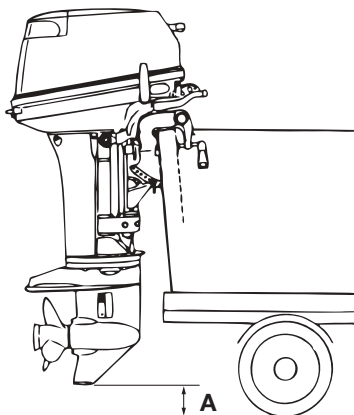

ENOF00074-0

A. Ground clearance should be provided sufficiently.

ENOW00073-0

⚠ WARNING

Please disconnect fuel connector except when operating engine. Fuel leakage is a fire or explosion hazard, which can cause serious injury or death.

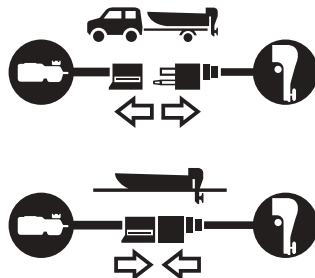

ENOF00075-0

ADJUSTMENT

ENOM00227-0

1. Steering friction

The steering friction can be adjusted in accordance with your preference by turning the steering adjustment screw.

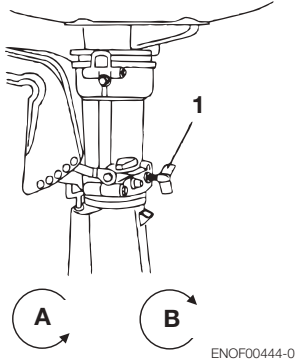

ENOF00444-0

- 1. Steering adjustment screw
- A. Lighter
- B. Heavier

ENON00221-0

Note

The steering adjustment screw is used to adjust the friction load of the steering, but not to fix the steering. Excess tightening of the adjustment screw may cause damage to the swivel bracket.

ENOM00074-0

2. Throttle grip

Friction adjustment of the throttle grip can be made with the throttle adjustment screw.

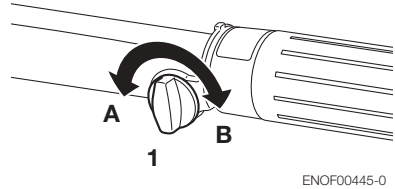

ENOF00445-0

- 1. Throttle adjustment screw
- A. Lighter
- B. Heavier

ENOW00074-0

WARNING

Do not overtighten the throttle grip or remote control tensioner or it could result in difficulty of movement resulting in the loss of control causing an accident and could lead to severe injury.

INSPECTION AND MAINTENANCE

ENOM00077-0

Care of your outboard motor

To keep your outboard motor in the best operating condition, it is very important that you perform daily and periodic maintenance as suggested in the maintenance schedules that follow.

ENOW00077-0



CAUTION

- **Your personal safety and that of your passengers depends on how well you maintain your outboard motor. Carefully observe all of the inspection and maintenance procedures described in this section.**
- **The maintenance intervals shown in the checklist apply to an outboard motor in normal use. If you use your outboard motor under severe conditions such as frequent full-throttle operation, frequent operation in brackish water, or for commercial use, maintenance should be performed at shorter intervals. If in doubt, consult your dealer for advice.**
- **We strongly recommend that you use only genuine replacement parts on your outboard motor. Damage to your outboard motor arising from the use of other than genuine parts is not covered under the warranty.**

ENOM00078-0

EPA Emissions Regulations

EPA (United States Environmental Protection Agency) has emission regulations regulating air pollution from new outboard motors. All new outboard motors manufactured by us are certified to EPA as conforming to the requirements of the regulations. This certification depends upon factory standards. Therefore, factory specifications must be followed when servicing emission related controls, or making adjustments. **Maintenance, replacement, or repair of the emission control devices and systems may be performed by any marine SI (Spark Ignition) engine repair establishment or individual.**

ENOM00428-0

1. Daily Inspection

Perform the following checks before and after use.

ENOM00078-0

 **WARNING**

Do not use outboard motor if any abnormality is found during pre-operation check or it could result in severe damage to the motor or severe personal injury.

Item	Points to Check	Remedy
Fuel System	<ul style="list-style-type: none"> • Check the amount of fuel in the tank. • Check for debris or water in the fuel filters. • Check the rubber hoses for fuel leakage. 	Replenish Clean or replace Replace
Fuel Tank and Cap	<ul style="list-style-type: none"> • Check for crack, leakage, damage in the fuel tank and cap. • Check for crack, damage in the gasket and tether. • Check for leakage at full close. • Check for ratchet performance. 	Replace Replace Replace Replace
Engine Oil	<ul style="list-style-type: none"> • Check the oil level. 	Fill to the upper level mark on dipstick
Electrical Equipment	<ul style="list-style-type: none"> • Check that the main switch functions normally. • Check that the battery electrolyte level and specific gravity are normal. • Check for loose connections on the battery terminal. • Check that the stop switch functions normally and make sure the lock plate is there. • Check cords for loose connections and damage. • Check the spark plugs for dirt, wear and carbon build-up. 	Replace Replenish or recharge Retighten Remedy or replace Correct or replace Clean or replace
Throttle System	<ul style="list-style-type: none"> • Check carburetor linkage is working normally when turning the throttle grip. 	Correct
Recoil Starter	<ul style="list-style-type: none"> • Check the rope for wear and chafing. • Check the ratchet engagement. 	Replace Correct or replace
Clutch and Propeller System	<ul style="list-style-type: none"> • Check that clutch engages correctly when operating the shift lever. • Visually Check propeller for bent or damaged blades. • Check the propeller nut is tightened and the split pin is present. 	Adjust Replace
Installation of Motor	<ul style="list-style-type: none"> • Check all the bolts attaching the motor to the boat. • Check the thrust rod installation. 	Tighten
Cooling Water	<ul style="list-style-type: none"> • Check that cooling water is discharged from the cooling water check port after the engine has started. 	Repair
Tools and Spares	<ul style="list-style-type: none"> • Check that there are tools and spare parts for replacing spark plugs, the propeller, etc. • Check that you have the spare rope. 	
Steering Devices	<ul style="list-style-type: none"> • Check the operation of the steering handle. 	Repair
Other parts	<ul style="list-style-type: none"> • Check if the anode is securely installed. • Check the anode for corrosion and deformation. 	Repair if necessary Replace

ENOM00080-0

Maintaining engine oil

If the engine oil is low, the life of the engine will be shortened significantly.

ENOM00429-0

Checking oil level

1. Stop the engine and set it in a vertical position.
2. Remove the top cowl.
3. Remove the oil filter cap.
4. Wipe oil on the oil dipstick with a clean rag.
5. Screw in the dipstick into the oil filter mouth (screw in completely).
6. Take out the dipstick and check the oil level.
7. Reset the dipstick in to the oil filter mouth.

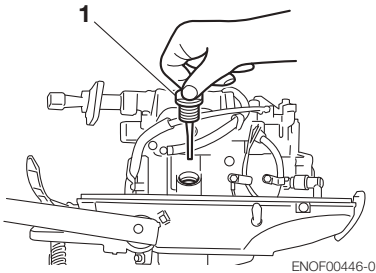

1. Oil filler cap (Dipstick)

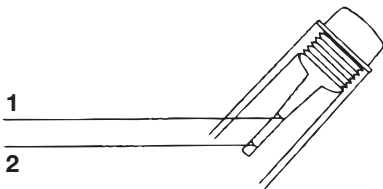

ENOF00447-0

1. Upper lever 450 mL
2. Lower lever 350 mL

ENON00024-0

Note

The oil level should be checked when the engine is cold.

ENON00025-0

Note

Consult with an authorized dealer if the engine oil is milky color, or appears contaminated.

ENOM00082-0

Replenishing engine oil

If the oil level is low, or at lowest mark, add recommended oil to the upper dipstick mark.

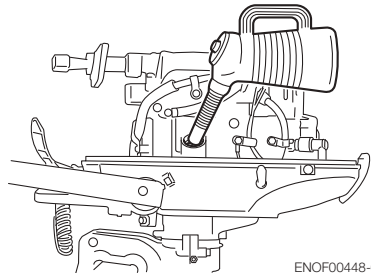

ENOW00079-0

CAUTION

- Do not add engine oil of brand and grade other than existing one. In case engine oil of other brand or grade is added, drain all oil and ask dealer for treatment.
- In case other than engine oil such as gasoline is put in the oil chamber, empty the chamber and ask dealer for treatment.
- When replenishing engine oil, be careful not to allow entry of foreign matters such as dust and water into oil chamber.
- Wipe off engine oil well immediately if spilled.

- Do not replenish engine oil over upper limit. If overfilled, remove oil to upper limit. If engine oil is over the upper limit, it can leak potentially leading to engine damage.

ENOM00083-0

Washing outboard motor

If outboard motor is used in salt water, brackish water or water with a high acidic level, use fresh water to remove salt, chemicals or mud from exterior and cooling water passage after every cruising or before storing outboard motor for long time. Before flushing, remove the propeller and the forward thrust holder.

ENOW00080-0

CAUTION

Keep cooling water passage free of clogs, or lack of cooling water flow could lead to engine overheating, potentially resulting in engine trouble.

ENON00026-0

Note

It is recommended to check chemical properties of water on which your outboard motor is regularly used.

ENOW00081-0

WARNING

Do not start engine without removing propeller, or accidentally turning propeller could cause personal injury.

ENOW00082-0

WARNING

Never start or operate the engine indoors or in any space which is not well ventilated. Exhaust gas contains carbon monoxide, a

colorless and odorless gas which can be fatal if inhaled for any length of time.

ENOM00430-0

Use flushing attachment.

1. Remove propeller (refer to Propeller Replacement). Remove the water plug from the motor, and screw in the flushing attachment.
2. Attach a water hose to the flushing attachment. Turn on the water and adjust the flow. (Be sure to seal the water inlet, located in the gear case, with tape.)
3. Start the engine and run it at idle speed in neutral shift position.
4. Check for a steady stream of water flowing out of the water pump indicator hole. Continue flushing the outboard motor for 3 to 5 minutes, carefully monitoring water supply at all times.
5. Stop the engine, turn off the water, and remove the flushing attachment and tape. Reinstall the propeller.

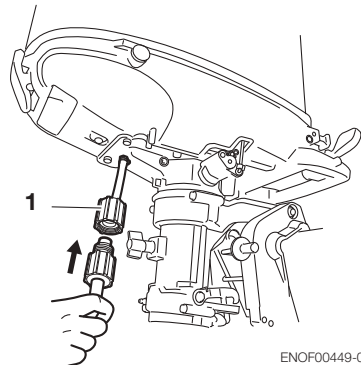

ENOF00449-0

1. Flushing attachment (option)

ENOW00083-0

CAUTION**Keep engine at idle speed during flushing.**

ENOM00086-0

Replacing the propeller

A worn-out or bent propeller will lower the motor's performance, and cause engine trouble.

Before removing the propeller, remove the spark plug caps from the spark plugs to protect against personal injury.

ENOW00084-0

WARNING

Do not begin propeller removal and installation procedure with spark plug caps attached, shift in forward or reverse, main switch at other than "OFF", engine stop cord attached to the switch, and starter key attached, or engine could accidentally start leading to serious personal injury. Disconnect battery cable if possible.

1. Remove the split pin, propeller nut and washer.
2. Remove the propeller and thrust holder.
3. Apply genuine grease to the propeller shaft before installing a new propeller.
4. Install the thrust holder, propeller, washer and propeller nut onto the shaft.
5. Install a new split pin into the nut hole and bend it.

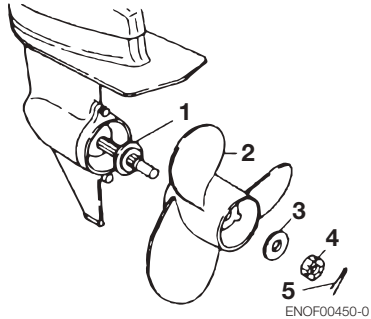

1. Propeller shaft holder
2. Propeller
3. Washer
4. Nut
5. Split pin

ENOW00085-0

WARNING

Do not hold propeller with hand(s) when loosening or tightening propeller nut. Put a piece of wood block between propeller blade and anti-ventilation plate to hold propeller.

ENOW00086-0

CAUTION

- Do not install propeller without thrust holder, or propeller boss could be damaged.
- Do not reuse split pin.
- After installing split pin, spread the pin apart to prevent it from falling out which could lead to the propeller coming off during operation.

ENOM00087-0

Replacing the spark plugs

ENOW00087-0

WARNING

- Do not reuse spark plug with damaged insulation, or sparks can leak through

crack, potentially leading to electric shock, explosion and/or fire.

- **Do not touch spark plugs immediately after stopping engine as they will be hot and could cause severe burns if touched. Allow motor to cool down first.**

If the spark plug(s) is fouled, has carbon build up, or is worn, it should be replaced. When reusing spark plugs, remove dirt from the electrodes and adjust spark gap to specification.

ENON00027-0

Note

When inspecting the plug, always clean the gasket surface and use a new gasket. Wipe off any dirt from the threads and screw in the spark plug to the correct torque.

1. Stop the engine.
2. Remove the top cowl.
3. Remove the spark plug caps.
4. Remove the spark plugs by turning it counter-clockwise, using a 5/8" socket wrench and handle.
5. Attach spark plug and tighten to specified torque.

Use spark plug NGK DCPR-6E.

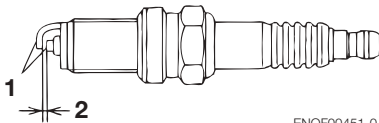

ENOF00451-0

1. Electrode
2. Spark gap (0.8–0.9 mm, 0.031–0.035 in)

ENON00028-0

Note

- **Spark plug torque:
18.0 Nm (13.3 ft-lb) [1.84 kgf-m]**

If a torque-wrench is not available when you are fitting a spark plug, a good estimate of the correct torque is 1/4 to 1/2 a turn past

finger-tight. Have the spark plug adjusted to the correct torque as soon as possible with a torque-wrench.

ENOM00088-0

Replacing the anode

A sacrificial anode protects the outboard motor from galvanic corrosion. Anode is located on the gear case and the cylinder. When the anode is eroded more than 2/3, replace it.

ENON00029-0

Notes

- Never grease or paint the anode.
- At each inspection re-tighten the anode attaching bolt. As it is likely to be subjected to electrolytic corrosion.

ENOM00431-0

2. Periodic inspection

It is important to inspect and maintain your outboard motor regularly. At each interval on the chart below, be sure to perform the indicated servicing. Maintenance intervals should be determined according to the number of hours or number of months, whichever comes first.

Description		Inspection intervals				Inspection procedure	Remarks
		First 20 hours of 1 month	Every 50 hours of 3 months	Every 100 hours of 6 months	Every 200 hours of 1 year		
Fuel System	Carburetor ^{*1}			●	●	Strip, Clean, and adjust.	
	Fuel filter	●	●	●	●	Check and clean or Replace if necessary.	Entire cartridge
	Piping/Hoses ^{*2}	●	●	●	●	Check and clean or Replace if necessary.	
	Fuel tank ^{*2}	●		●	●	Clean	
	Fuel tank cap ^{*2}	●	●	●	●	Check and clean or Replace if necessary.	
	Fuel pump ^{*1}	●	●	●	●	Check and clean or Replace if necessary.	Disassemble and check each 300 hours.
Ignition	Spark plug	●		●	●	Check gaps. Remove carbon deposits or Replace if necessary.	0.8–0.9 mm (0.031–0.035 in)
	Ignition timing ^{*1}	●		●	●	Check timing.	
Starting System	Starter rope	●	●	●	●	Check for wear or chafing.	
Engine	Engine oil	Replace ●		Replace ●	Replace ●	Replace if necessary.	
	Valve Clearance ^{*1}	●		●	●	Check & adjust.	IN: 0.06–0.14 mm (0.0024–0.0055 in) EX: 0.11–0.19 mm (0.0043–0.0075 in)
	Thermostat ^{*1}			●	●	Check and Replace if necessary.	
Lower Unit	Propeller	●	●	●	●	Check for bent blades, damage, wear.	
	Gear oil	Replace ●	●	Replace ●	Replace ●	Change or replenish-oil and check for water leaks.	195 mL (6.6 fl.oz)
	Water pump ^{*1}		●	●	●	Check for wear or damage.	Replace impeller every 12 months.
Warning System ^{*1}			●	●	●	Check function.	
Bolts and Nuts		●	●	●	●	Retighten	
Sliding and Rotating Parts. Grease Nipples		●	●	●	●	Apply and pump in grease.	
Outer Equipment		●	●	●	●	Check for corrosion.	
Anode			●	●	●	Check for corrosion and deformation.	Replace if necessary.

*1: Have this handled by your dealer.

*2: In USA, you have to use EPA approved part (See pages 18–19).

ENON00030-0

Note

Your outboard motor should receive careful, and complete inspection at 300 hours. This is the best time for major maintenance procedures to be carried out.

ENOM00432-0

Replacing engine oil

Engine oil mixed with dust or water will dramatically shorten the life of the engine.

To change engine oil:

1. Stop the engine and set it in a vertical position.
2. Remove the top cowl and oil filler cap. Allow it to cool.
3. Put a oil drain pan under the oil drain screw.
4. Remove the oil drain screw and completely drain oil from the engine.
5. Tighten the oil drain screw.
6. Fill the engine through filler port with recommended oil (see chart below) to the upper dipstick mark.
7. Tighten the oil filler cap.

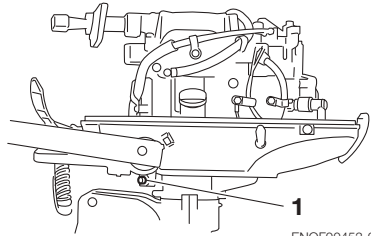

ENOF00453-0

1. Oil drain screw

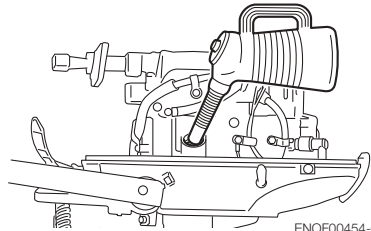

ENOF00454-0

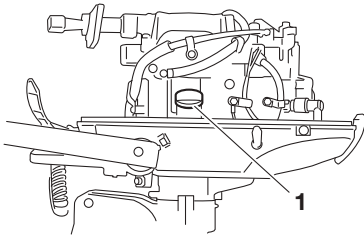

ENOF00452-0

1. Oil filler cap (Dipstick)

Use only high quality 4-stroke engine oil to insure performance and prolonged engine life.

Use oils that carry the API rating of SF, SG, SH, or SJ. Select the appropriate viscosity, based on atmospheric temperature, from the chart below.

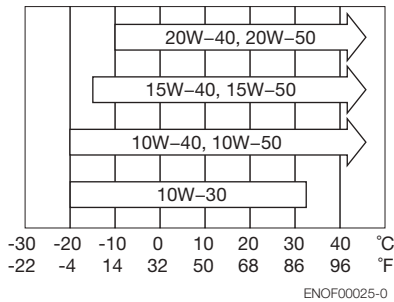

You can also use NMMA FC-W certified 4-stroke outboard oil below.

10W-30: is recommended for use in all temperature.

25W-40: may be used at temperatures above 4°C (40°F).

ENOW00090-0

CAUTION

Use of engine oils that do not meet these requirements will result in reduced engine life, and other engine problems.

ENOW00091-0

CAUTION

You may be injured due to high engine temperatures if you fill engine oil just after stopping. Changing engine oil should be done after the engine has been cooled.

ENOW00092-0

CAUTION

- Do not overfill engine oil, or engine oil could leak and/or engine could be damaged. If engine oil level is over upper limit marks of oil gauge, drain oil to level lower than upper limit.
- Be sure that outboard motor is in upright and level position when checking or changing oil.

- Stop engine immediately if low oil pressure warning lamp is lit or oil leak is found, or engine could be severely damaged. Consult dealer.

ENON00031-0

Notes

- If any amount of water is found in engine oil, making it milky white, consult dealer.
- If engine oil is contaminated with fuel, emitting strong fuel smell, consult dealer.
- Some oil dilution is normal if engine is idled or trolled for long periods, especially in cooler water temperatures.

ENOM00093-0

Cleaning the fuel filters and the fuel tank

Fuel filters are provided inside the fuel tank and engine.

ENOM00093-0

WARNING

Gasoline and its vapors are very flammable and can be explosive.

- Do not start this procedure while engine is operating or hot even after stopping it.
- Place fuel filter away from every source of ignition such as sparks or open flames.
- Wipe off gasoline well immediately if spilled.
- Install fuel filter with all related parts in place, or fuel leak could occur, leading to catching fire or explosion.
- Check fuel system regularly for leakage.
- Contact authorized dealer for fuel system services. Services by unqualified person could lead to engine damage.

ENOM00433-0

Fuel filter (for engine)

Replace the filter provided inside of engine cover if there is water or dirt inside.

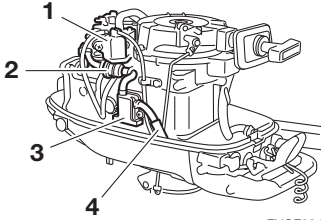

ENOF00455-0

- 1. Carburetor
- 2. Fuel filter
- 3. Fuel pump
- 4. Fuel pipe

ENOM00434-0

Fuel filter (for fuel tank)

Loosen the fuel pickup elbow shown at left, remove it and clean the fuel filter.

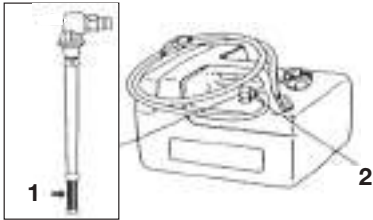

ENOF00456-0

- 1. Filter
- 2. Fuel pick up elbow

ENOM00097-0

Fuel tank

Water or dirt in the fuel tank will cause engine performance problems. Check and clean the tank at specified times or after the outboard motor has been stored for a long period of time (over three months).

ENOM00098-0

Replacing gear oil

ENOW00094-0

! WARNING

- Be sure that outboard motor is secured to transom or service stand, or accidental drop or fall of outboard motor could lead to severe personal injury.
- Be sure to lock outboard motor if it is tilted up, or accidental fall of outboard motor could lead to severe personal injury.
- Do not go under outboard motor tilted up and locked, or accidental fall of outboard motor could lead to severe personal injury.

1. Remove the oil plugs (upper and lower), and completely drain the gear oil into a pan.

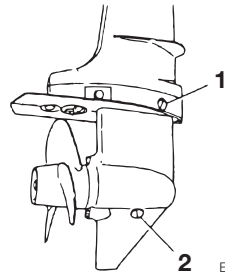

ENOF00463-0

- 1. Oil plug hole (Upper)
 - 2. Oil plug (Lower)
2. Insert the oil tube nozzle into the lower oil plug hole, and fill with gear oil by squeezing the oil tube until oil flows out of the upper plug hole.

ENOW00095-0

! CAUTION

Do not reuse oil plug gasket. Always use new gasket and tighten oil plug properly to prevent entry of water into lower unit.

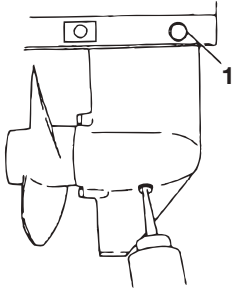

ENOF00457-0

1. Oil plug (Upper)
3. Install the upper oil plug, and then remove oil tube nozzle and install the lower oil plug.

ENON00032-0

Note

If water in the oil, giving it a milky colored appearance. Contact your dealer.

ENON00404-0

Note

Use genuine gear oil or the recommended one (API GL-5: SAE #80 to #90).
Required volume: approx. 195 mL.

ENOM00100-0

3. Off-season storage

Before you put your outboard motor in storage, it is a good opportunity to have it serviced and prepared by your dealer.

ENOW00096-0

CAUTION

Before servicing the motor for storage:

- Remove the battery cables.
- Remove the spark plug caps from the spark plugs.
- Do not run the motor out of the water.

ENOM00435-0

Engine

1. Wash the engine exterior and flush the cooling water system thoroughly with fresh water. Drain the water completely.
Wipe off any surface water with an oily rag.
2. Use a dry cloth to completely wipe off water and salt from the electrical components.
3. Drain all fuel from the fuel hoses, fuel pump, and carburetor, and clean these parts.
Keep in mind that if gasoline is kept in the carburetor for a long time, gum and varnish will develop, causing the float valve to stick, restricting the fuel flow.
4. Remove the spark plugs and spray storage oil (available from an authorized dealer) into the combustion chamber through the spark plug holes while slowly turning the motor over using the recoil starter.
5. Change the engine oil.
6. Change the gear oil in the gear case.
7. Apply grease to the propeller shaft.
8. Apply grease to all sliding parts, joints, nuts, and bolts.
9. Stand the outboard motor up vertically in a dry place.

ENOW00097-0

WARNING

Be sure to use cloth to remove fuel remaining in the cowl and dispose of it in accordance with local fire prevention and environment protection regulations.

ENOM00104-0

4. Pre-season check

1. Check that the shift and throttle function properly.
(Be sure to turn the propeller shaft when checking the shift function or else the shift linkage may be damaged.)

ENON00034-0

Notes

The following steps must be taken when first using the engine after winter storage.

1. Fill the fuel tank completely.
2. Warm up the engine for 3 minutes in the "NEUTRAL" position.
3. Run the engine for 5 minutes at the slowest speed.
4. Run the engine for 10 minutes at half speed.

In steps 2 and 3 above, the oil used for storage inside the engine will be flushed out to assure optimum performance.

2. Check the electrolyte level, and measure the voltage and specific gravity of the battery.

Specific Gravity at 20°C	Terminal Voltage (V)	Charge Condition
1.120	10.5	Fully discharged
1.160	11.1	1/4 charged
1.210	11.7	1/2 charged
1.250	12.0	3/4 charged
1.280	13.2	Fully charged

3. Check that the battery is secure and the battery cables are properly installed.

ENOM00105-0

5. Motor submerged in water

After taking your outboard motor out of the water, immediately take it to your dealer.

The following are the emergency measures to be taken for a submerged outboard motor, if you can not take it your dealer right away.

1. Wash the outboard motor with fresh water to remove salt or dirt.
2. Remove the engine oil drain screw and completely drain water and oil from the engine.
3. Remove the spark plugs, and completely drain the water from the engine by pulling the recoil starter several times.

Replace oil filter and oil to the correct level.

The oil and filter may need to be changed again after running a short period to get all moisture completely out of the crankcase.

4. Inject a sufficient amount of engine oil through the spark plug holes.

Pull the recoil starter several times to circulate the oil throughout the outboard motor.

ENOW00098-0



CAUTION

Do not attempt to start submerged outboard motor immediately after it is recovered, or engine could be severely damaged.

ENOM00106-0

6. Cold weather precautions

If you moor your boat in cold weather at temperatures below 0°C (32°F), there is the danger of water freezing in the cooling water pump, which may damage the pump, impeller, etc. To avoid this problem, submerge the lower half of the outboard motor into the water.

ENOM00107-0

7. Checking after striking underwater object

Striking the sea bottom or an underwater object may severely damage the outboard motor. Immediately bring the outboard motor to the dealer and ask for the following checks.

1. Looseness or damage of power unit installation bolts, gear case and extension case bolts, propeller shaft housing bolts, propeller or propeller shaft upper and lower mount rubber bolts, and/or mount bracket bolts.

Ask an authorized dealer to tighten any loose bolts and nuts, and to replace damaged parts.

2. Damage to mount rubber, the tilt stopper, thrust rod, gears and clutch, and/or propeller.

Ask an authorized dealer to replace damaged or defective parts.

TROUBLESHOOTING

ENOM00436-0

If you encounter a problem, consult the check list below to determine the cause and to take the proper action.

An authorized dealer will always be happy to provide any assistance and information.

	Engine failing to start	Engine starting but stopping soon	Poor idling	Poor acceleration	Engine speed abnormally high	Engine speed abnormally low	Boat speed low	Overheating of engine	Warning lamp ON	Possible cause
FUEL SYSTEM	•	•								Empty fuel tank
	•	•	•	•		•	•	•		Incorrect connection of fuel system
	•	•	•	•		•	•	•		Air entering fuel line
	•	•	•	•		•	•	•		Deformed or damaged fuel hose
	•	•	•	•		•	•	•		Closed air vent on fuel tank
	•	•	•	•		•	•	•		Clogged fuel filter, fuel pump, or carburetor
			•	•		•	•	•		Use of improper engine oil
	•	•	•	•			•	•		Use of improper gasoline
	•	•	•	•						Excessive supply of fuel
ELECTRICAL SYSTEM	•	•	•	•		•	•	•		Poor carburetor adjustment
	•	•	•	•		•	•			Spark plug other than specified
	•	•	•	•		•	•			Dirt, soot, etc. on spark plug
	•									No Spark or weak spark
	•									Short circuit of engine stop switch
	•		•	•			•	•		Ignition timing incorrect
	•									Lock plate not fitted
COMPRESSION & OIL SYSTEM		•	•	•		•	•			Disconnection of wire or loose ground connection
			•							Low compression
				•			•			Carbon deposits in the combustion chamber
								•		Incorrect valve clearance
								•	Low oil pressure/level	

		Engine failing to start	Engine starting but stopping soon	Poor idling	Poor acceleration	Engine speed abnormally high	Engine speed abnormally low	Boat speed low	Overheating of engine	Warning lamp ON	Possible cause
ENGINE OIL SYSTEM							●		●	●	Low oil level
									●	●	Use of improper oil
							●		●	●	Oil deterioration
							●		●	●	Clogged oil strainer
							●		●	●	Faulty oil pump
OTHERS	●			●	●		●	●			Incorrect adjustment of throttle link
								●	●		Insufficient cooling water flow, clogged or defective pump
				●				●	●		Faulty thermostat
					●	●		●	●		Cavitation or ventilation
					●	●	●	●	●		Incorrect propeller selection
				●	●	●	●	●	●		Damaged or bent propeller
					●	●		●	●		Improper thrust rod position
					●	●	●	●	●		Unbalanced load on boat
				●	●	●	●	●		Transom too high or too low	

TOOL KIT AND SPARE PARTS

ENOM00437-0

	Items	Quantity	Remark
Service tools	Tool bag	1	
	Pliers	1	
	Socket wrench	1	10 × 13 mm
	Socket wrench	1	16 mm
	Socket wrench handle	1	
	Screwdrivers	1	Cross-and straight-point
	Screwdriver handle	1	
Spare parts	Emergency starter rope	1	1000 mm
	Spark plug	1	NGK: DCPR6E
	Split pin	1	
Parts Packaged with Engine	Fuel tank	1	12 L
	Primer bulb	1 set	

OPTIONAL ACCESSORIES

ENOM00439-0

Fuel tank & Primer Bulb Ass'y (12 L)

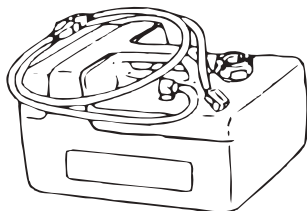

ENOF00458-0

Fuel filter kit

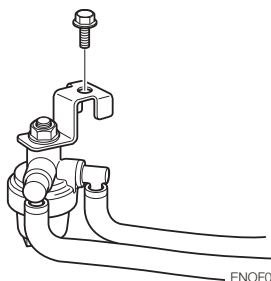

ENOF00461-0

Propeller



ENOF00459-0

Touch-up paint (300 mL)



ENOF00105-0

Genuine engine oil (450 mL)



ENOF00106-0

Flushing attachment

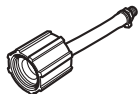

ENOF00460-0

Remote control box

Various kinds of fitting parts are available.
Please consult with your dealer.

Genuine gear oil (500 mL)

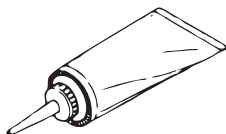

ENOF00104-0

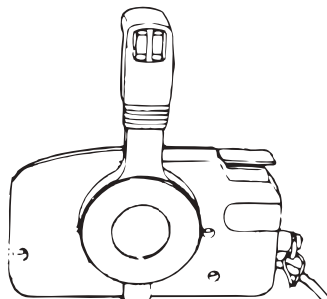

ENOF00462-0

PROPELLER TABLE

ENOM00438-0

Use a genuine propeller.

A propeller must be selected so that the engine rpm measured at wide open throttle while cruising is within the recommended range.

4: 4500–5500 rpm

5: 4500–5500 rpm

6: 5000–6000 rpm

	Propeller Mark	Propeller Size (Diameter × pitch)		Standard propeller on the model		
		inch	mm	4	5	6
Light boats	9	7.9 × 9.0	200 × 229			
	8	7.8 × 8.0	198 × 203		S, L, UL	S, L
	7	7.8 × 7.0	198 × 178	S, L, UL		*UL
Heavy boats	6	7.9 × 6.0	200 × 152			

S: Short shaft

L: Long shaft

UL: Extra long shaft

*: SP

NISSAN MARINE CO., LTD