

NISSAN OUTBOARD MOTOR

4-stroke

NSF 9.9B2

NSF 15B2

NSF 18B2

OWNER'S OPERATING MANUAL

<https://www.boat-manuals.com/nissan/>

No. 405N1107L 5

Copyright © 2007 Nissan Marine Co. Ltd. All rights reserved. No part of this manual may be reproduced or transmitted in any form or by any means without the express written permission of Nissan Marine Co., Ltd.

<https://www.boat-manuals.com/nissan/>

YOUR NISSAN OUTBOARD MOTOR

OWNER REGISTRATION AND IDENTIFICATION

Upon purchasing this product, be sure your dealer* fills out the WARRANTY CARD correctly, completely and mails it to the distributor. This card identifies you as the legal owner of the product and serves as your warranty registration. If this procedure is not followed, your outboard motor will not be covered by warranty.

* In this manual "dealer" always means an authorized NISSAN Dealer.

PRE-DELIVERY CHECK

Be sure that the product has been checked by the dealer before delivery.

Limited Warranty

This NISSAN product is fully guaranteed against defective materials and workmanship for the period from the date of purchase, provided that the purchase has been registered in accordance with the above.

The limited warranty will not apply to the normal wear and tear of parts, adjustments, tune-ups, or to any damage caused by, but not limited to:

- 1) Use or operation NOT conforming to the instructions described in this owner's manual.
- 2) Participation in or preparation for racing or other competitive activities.
- 3) Water entering the engine.
- 4) Damage from accidents, collisions, contact with foreign materials, or submersion.
- 5) Growth of marine organisms on motor surfaces.
- 6) Any other careless use or operation.
- 7) Normal deterioration.

The limited warranty does not cover maintenance items. The following items are a few examples not covered by the limited warranty:

Spark plugs, Anode, Trim-tab, Propeller, Fuel filter, Oil filter, Carbon brush, Starter rope, Shear-pin, Split-pin, Bolt nut washer, Wire cable, Rubber goods: water pump impeller, oil seal, "O" ring, fuel hose primer bulb, vinyl tube etc.

The limited warranty will become void if the product has been altered, modified, or repaired by anyone other than a company or service firm authorized by NISSAN.

The limited warranty will cover only your NISSAN product and will not cover the boat the product is mounted on, the trailer, equipment, or accessories associated with the product.

Serial Number

In the space below, please record the engine's serial number (indicated both on the lower motor cover and on the cylinder block). This number will come in handy in the event of theft or to help in quickly identifying the product type.

Serial Number: _____

To You, Our Customer:

Thank you for selecting a NISSAN product. You are now the proud owner of an excellent outboard engine that will service you for many years to come.

We would like to point out that carefree usage can only be assured on condition that this manual is read through in its entirety and the maintenance routines described later in this manual are followed carefully. Should difficulty arise with the engine, please follow the troubleshooting procedures listed at the end of this manual. If the problem persists, contact an authorized NISSAN service shop or your dealer.

We hope you will get much enjoyment from this product and wish you good luck in your boating adventures.

NISSAN MARINE

NOTICE: DANGER/WARNING/CAUTION/Note

Before operating your outboard motor, be sure to thoroughly read and understand this Owner's Manual and follow all of the instructions shown. Of particular importance is information preceded by the words "DANGER," "WARNING," "CAUTION," and "Note." Always pay special attention to such information to ensure safe and trouble-free operation at all times.

▲ DANGER

Failure to observe will result in severe personal injury or death.

▲ WARNING

Failure to observe could result in severe personal injury or death.

▲ CAUTION

Failure to observe could result in personal injury, or product or property damage.

Note:

This instruction provides special information to facilitate the use or maintenance of the outboard or to clarify important points.

EMERGENCY STOP SWITCH

The Emergency stop switch will stall the engine when the stop switch tether is pulled out. This line can be attached to the body of the operator, effectively preventing injuries from the propeller in case boater falls overboard.

We highly recommend use of the Emergency stop switch line. However, we would also like to point out the drawbacks of the switch. Accidental activation of the switch (such as the line being pulled out in heavy seas) could cause passengers to lose their balance and even fall overboard, or it could result in loss of power in heavy seas, strong currents, or high winds. Loss of control while mooring is another potential hazard.

To prevent such hazardous situations, the 500 mm (20 inch.) line is coiled and can be extended to a full 1,300 mm (51 inch.)

WARNINGS

As the operator/driver of the boat, you are responsible for the safety of those aboard and those in other crafts around yours, and for following local boating regulations. Therefore you should possess thorough knowledge of correct operation of the boat, engine, and accessories. To learn about the correct operation and maintenance of the engine, please read through this manual carefully.

It is very difficult for a person standing or floating in the water to take evasive action should he or she see a power boat heading in his/her direction, even at a slow speed. Therefore, when your boat is in the immediate vicinity of people in the water, the engine should be shifted to neutral and shut off.

SERIOUS INJURY IS LIKELY IF A PERSON IN THE WATER MAKES CONTACT WITH A MOVING BOAT GEAR HOUSING, PROPELLER, OR ANY SOLID DEVICE RIGIDLY ATTACHED TO A BOAT OR GEAR HOUSING.

It is the operator's responsibility to perform all safety checks and to ensure that all lubrication and maintenance instructions are complied with for safe operation. It is also the operator's responsibility to return the unit to the local dealer for periodic inspection.

Correct periodic maintenance and proper use of this outboard engine will lessen the chance of problems and keep overall operating expenses at a minimum.

SERVICING, REPLACEMENT PARTS & LUBRICANTS

Only at an authorized NISSAN service shop perform service or maintenance on this product. Be sure to use genuine parts, genuine lubricants, or recommended lubricants.

MAINTENANCE

As the owner of this outboard engine, you must be acquainted with correct maintenance procedures. Please comply with all instructions concerning lubrication and maintenance, and you should return the engine to the dealer, or service shop, for periodic inspection at the prescribed intervals.

Troublefree operation cannot be expected unless the engine receives adequate periodic maintenance. If proper maintenance is performed, it is not likely that a costly repair will ever be required.

USE OF SERVICE SHOP

We recommend that you use only authorized dealers to carry out all of your maintenance and repair needs.

CONTENTS

	Page
1. SPECIFICATIONS	1
2. NAMES OF PARTS	2
3. INSTALLATION	3
1. MOUNTING THE ENGINE ON BOAT	3
2. INSTALLING THE REMOTE CONTROL DEVICES	4
3. INSTALLING THE BATTERY	7
4. PRE-OPERATING PREPARATIONS	8
1. GASOLINE AND ENGINE OIL	8
2. BREAK-IN	10
3. ENGINE OIL WARNING LAMP	10
4. ESG	11
5. ENGINE OPERATION	12
1. STARTING	12
2. WARMING UP THE ENGINE	16
3. FORWARD AND REVERSE	17
4. STOPPING	19
5. TRIM ANGLE	20
6. TILT UP, TILT DOWN	21
7. SHALLOW WATER OPERATION	22
6. REMOVING AND CARRYING THE MOTOR	23
1. REMOVING THE MOTOR	23
2. CARRYING THE MOTOR	23
3. STORING THE MOTOR	23
7. TRAILERING	24
8. ADJUSTMENT	25
9. INSPECTION AND MAINTENANCE	26
1. DAILY INSPECTION	27
2. PERIODIC INSPECTION	32
3. OFF-SEASON STORAGE	37
4. PRE-SEASON CHECK	38
5. MOTOR SUBMERGED IN WATER	39
6. COLD WEATHER PRECAUTIONS	39
7. CHECKING AFTER STRIKING UNDERWATER OBJECT	39
10. TROUBLESHOOTING	40
11. TOOL KIT AND SPARE PARTS	43
12. OPTIONAL ACCESSORIES	44
13. PROPELLER TABLE	45
14. WIRING DIAGRAMS	46

1. SPECIFICATIONS

Item	MODEL	9.9B2 MF	9.9B2 EF	9.9B2 EP
		15B2 MF	15B2 EF	15B2 EP
		18B2 MF	18B2 EF	18B2 EP
Overall Length,	mm (in)	980 (38.6)		650 (25.6)
Overall Width,	mm (in)	365 (14.4)		345 (13.6)
Overall Height,	S • L mm (in)	1,063 (41.9) • 1,212 (47.7)		
Transom Height,	S • L mm (in)	413 (16.3) • 562 (22.1)		
Weight,	S Kg (lb)	51.5 (114)	55 (121)	53.5 (118)
	L Kg (lb)	52.5 (116)	56 (124)	54.5 (120)
Output,	kW (Hp)	9.9B2 : 7.3 (9.9)	15B2 : 11.0 (15)	18B2 : 13.2 (18)
Max. Operating Range,	rpm	9.9B2 : 4,500	15B2 : 5,000	18B2 : 5,500
Engine Type		4-Stroke		
Number of Cylinders		2		
Bore and Stroke,	mm (in)	59.0 × 60.0 (2.32 × 2.36)		
Piston Displacement,	ml. (Cu in)	328 (20.01)		
Exhaust System		Through hub exhaust		
Cooling System		Water cooling		
Engine Lubrication		Trochoid pump		
Starting System		Manual	Electric starter motor *	
Ignition System		Flywheel Magneto C.D. ignition		
Spark Plugs		NGK DCPR6E		
Trim Stages		6 Position		
Engine Oil		API SF or SG or SH or SJ SAE 10W 30/40, Approx. 1,000ml.		
Gear Oil		Genuine Gear Oil or API GL5, SAE #80- 90, Approx. 370ml.		
Fuel Tank Capacity,	L (US gal)	12 (3.17)		
Gear Reduction Ratio		2.15 (13 - 28)		

* - with manual

2. NAME OF PARTS

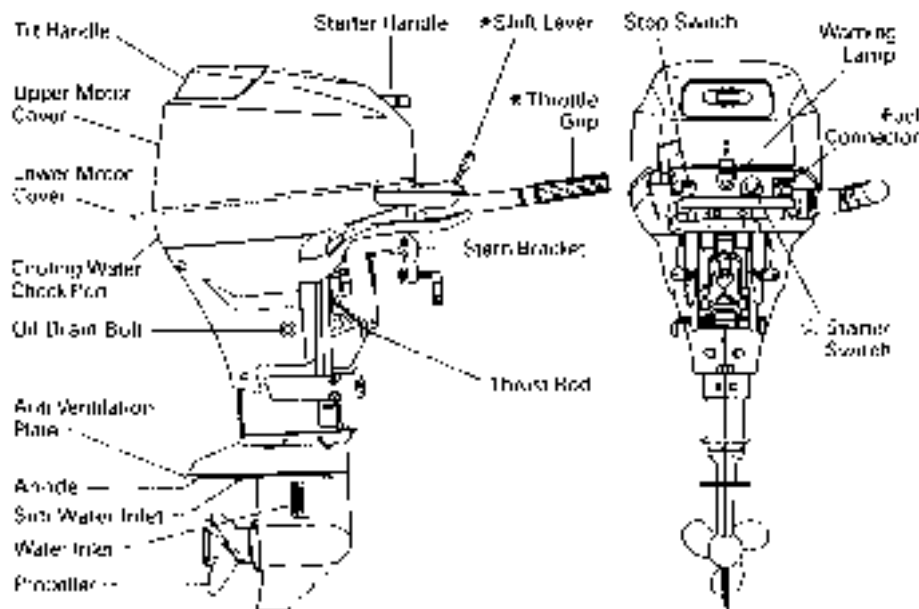

* MF and EF type only
 ○ EF type only.

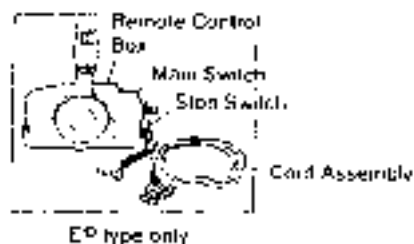
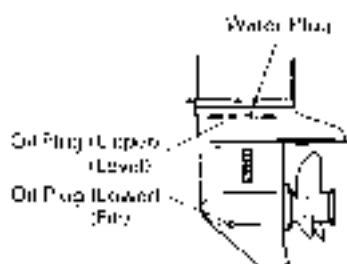

3. INSTALLATION

▲ WARNING

Most boats are rated and certified in terms of their maximum allowable horsepower, and this is shown on the boat's certification plate. Do not equip your boat with an outboard that exceeds this limit. If in doubt, contact your dealer.

Do not operate the engine unit until it has been securely mounted on the boat in accordance with the instructions below.

3-1. Mounting the engine on boat

(1) Position . . . above keel line

● Set engine at center of boat.

(Fig. 1)

Center of Boat

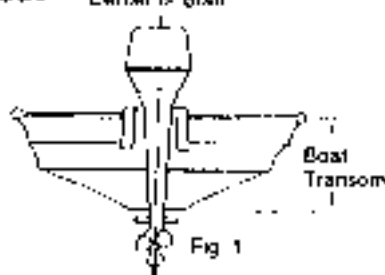

Fig. 1

(2) Transom matching

Be sure that the anti-ventilation plate of the outboard is below the water surface when running with the throttle wide open. (Fig. 2)

If the above condition cannot be met due to the shape of the bottom of your boat, please consult your dealer.

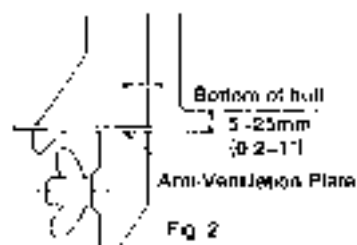

Fig. 2

(3) To attach the engine to the boat, tighten the clamp screws by turning their handles.

Also, tighten the bolts. Secure with a rope, to prevent loss overboard (Fig. 3)

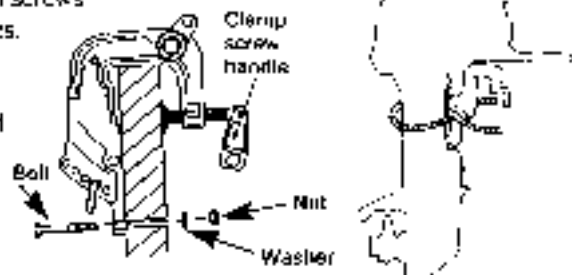

Fig. 3

3-2. Installing the remote control devices

It is recommended to consult with your dealer for installation and adjustment of the remote control device.

(1) Installation of the Remote Control Cables (Box side)

Follow the instruction manual provided with the remote control box.

(2) Installation of the Remote Control Box on your boat

Follow the instruction manual provided with the remote control box.

(3) Installing of the Remote Control Cable (engine side) and the Control Assembly (Wiring Harness)

(D) Fitting of connecting parts to cables

Screw the top of the remote control cable into the cable joint up to approx. 10 mm (0.39 inch), then lock them with a lock nut. Here, apply grease to the hole of the cable joint.

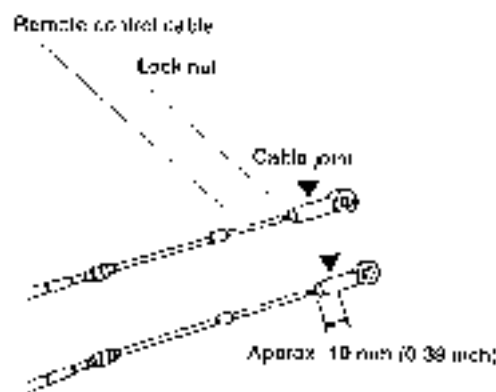

2) Fitting of Remote Control Cable to Engine

Note:

Put the control lever on the Neutral position and the Neutral warm-up lever in the fully closed position.

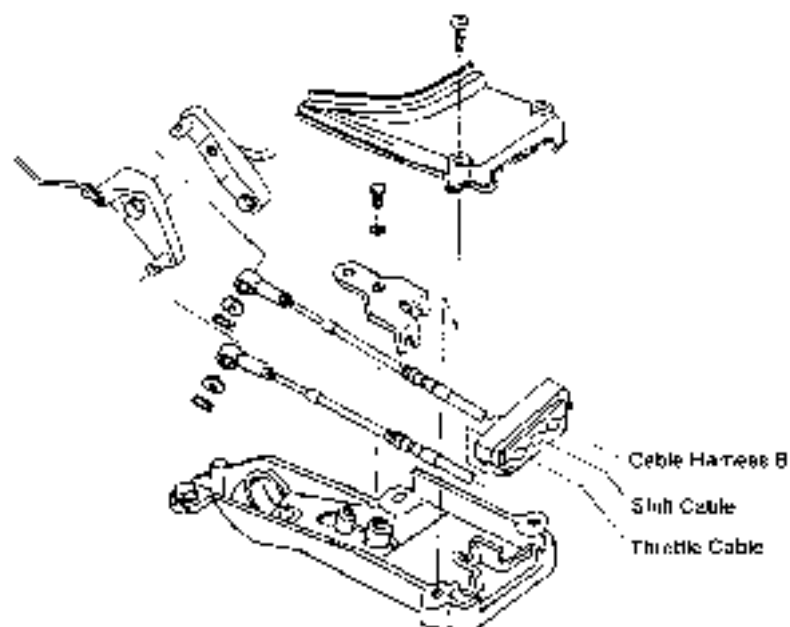

Note:

Confirm whether the engine side shift is in gear when shifting the control lever of the Remote Control Box to its first position in Forward or Reverse (about 3/2 ") and whether the throttle of the carburetor is fully open when shifting the lever further.

Confirm whether the carburetor's throttle is fully closed when the control lever is shifted to the Neutral position

(3) Connecting the Cord assembly (Wiring Harness)

Connect cable harness B to cable harness A

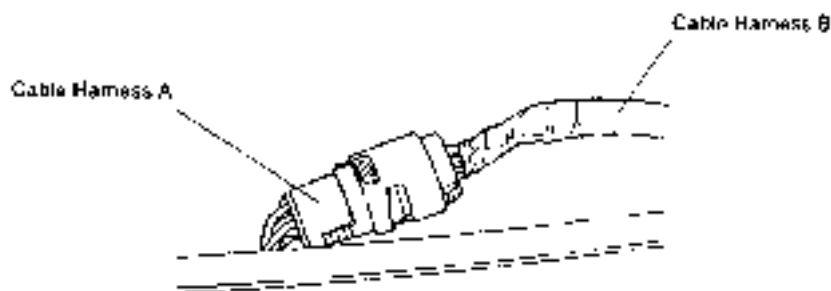

3-3. Installing the battery

- (1) Place the battery box in a convenient position away from possible spray damage. Securely fasten both the box and battery so they do not shake loose.

Recommended battery : 12V, 70AH

A WARNING

Hydrogen gas is generated when a battery is charged. Therefore, keep the battery well ventilated during charging.

Electric sparks, cigarette smoking and other sources of fire must be avoided in the charging area to prevent explosion of the battery.

* The battery fluid (electrolyte) contains sulfuric acid.

If any electrolyte is spilled on the skin, clothes, etc., wash with copious amounts of water and consult a doctor. Always use safety glasses and rubber gloves when handling the battery.

Remark: Further to notice on the label of your battery.

Notes:

- (1) Make sure that the battery leads do not get stuck between the motor and boat when turning, etc.
- (2) The starter motor may fail to operate if the leads are incorrectly connected.
- (3) Be sure to correctly connect the (+) and (-) leads. If not, the charging system will be damaged.
- (4) Do not disconnect the battery leads from battery while the engine is operating, the electrical parts could be damaged.
- (5) Always use a fully charged battery

- (2) Connect the positive lead (+) to the positive terminal (+) of the battery, and then connect the negative lead (-). When disconnecting the battery always remove the negative lead (-) first. After connecting the positive terminal (+), securely place a cap on it to prevent short circuits.

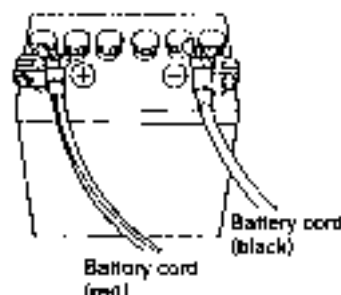

4. PRE-OPERATING PREPARATIONS

4-1. Gasoline and engine oil

▲ DANGER

Gasoline vapors are present, an errant spark could cause an explosion or fire.

- Do not smoke near gasoline.
- Do not overfill gasoline tank.
If any gasoline is spilled, wipe it up immediately.
- Stop the engine before filling gasoline tank

● Required Gasoline types

Unleaded, minimum pump posted 87 octane gasoline is recommended (Octane is based on posted rating)
(91 based on the research octane rating method)

Note:

Use of low-quality gasoline results in a short engine life as well as starting difficulties and other engine problems.

Note:

- (1) Gasoline containing alcohol (methanol (methyl), or ethanol (ethyl)), acetone or benzene, may cause:
 - Wear and damage to bearings, cams, piston(s), piston rings
 - Corrosion of metal parts.
 - Deterioration of rubber parts and plastic parts.
 - Starting, idling, and other engine performance problems.
- (2) Do not use gasoline that contains more than 10% ethanol or more than 5% methanol.
- (3) Damages resulting from the use of gasolines that contain alcohol are not covered under the limited warranty

● Engine Oil

Use only high quality 4-stroke engine oil to insure performance and prolonged engine life.

Use only oils that carry the API rating of SF, SG, SH or SJ. Select the appropriate viscosity, based on atmospheric temperature, from the chart below.

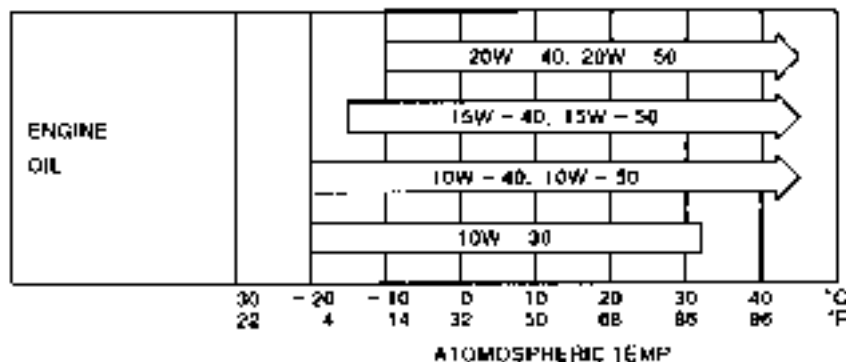

Note:

Use of engine oils that do not meet these requirements will result in reduced engine life, and other engine problems.

⚠ CAUTION

The engine oil is drained for shipping from the factory. Be sure to fill the engine to the proper level before starting engine. (To properly fill the engine with oil follow the instructions in section 9 of this manual.)

4-2. Break-In

Break-in period 10 hours

Note:

You must break-in the engine by operating it for 10 hours according to the chart below.

Time	0	10 min.	2 hrs.	3 hrs.	10 hrs. -
Method of operation	Idling or trolling	Throttle open less than 1/2 of the way (about 3,000 rpm)	Throttle open less than 3/4 of the way (about 4,000 rpm)	Throttle open 3/4 of the way (about 4,000 rpm)	Normal operating
Conditions	Cruising at no more than minimum speed		A full-throttle run is allowed for 1 min. every 10 min.	A full-throttle run is allowed for 2 min. every 10 min.	

4-3. Engine oil warning lamp

Oil pressure is required to lubricate internal engine parts.

When the warning lamp (Red) is off, it indicates that oil pressure is present.

Remark: When engine is first started, the red light will turn on for several seconds to confirm that it is working and then turn off.

▲ CAUTION

Never run the engine if the warning lamp is on or blinking on and off.

When the warning lamp is on or blinking on and off, as an additional alert of the low oil pressure condition, the engine will run rough and not exceed 2,000 rpm.



-
- * Stop the engine immediately and check the engine oil level.
If the oil level is lower than the appropriate level: Replenish engine oil.
If the oil level is within the appropriate level: Consult with your dealer.

4-4. ESG (A device preventing over revolution)

ESG is a device to prevent over revolution of the engine (more than approximately 6,250 rpm).

If you sense that the ESG is activated return to shore at a reduced speed (rpm).

Possible causes of ESG activation are: Worn, broken, bent propeller. Slipping propeller rubber. Making sharp turns at high speeds.

Note:

If the engine speed drops frequently after restarting the engine, please contact your service shop.

5. ENGINE OPERATION

Before starting

Before starting engine for the first time, after re-assembled engine and off-season storage, disconnect stop switch lock and pull the starter handle completely out approximately 10 times. This will help in priming of the oil pump.

5-1. Starting

▲ WARNING

Be sure to connect the emergency tethered stop hook to your waist or clothing.

The engine will shut down when the switch lock becomes disconnected from the engine.

Note:

The engine will not start unless the switch lock has been properly connected into the emergency stop switch.

Note:

Do not operate the engine with gear case out of water. Severe personal injury, or engine damage will result.

① Loosen the air vent screw on the tank cap.

② Attach the fuel connector to the engine connector.
The arrow mark on the primer bulb should be facing the engine.

③ Feed fuel to the carburetor by squeezing the primer bulb until it is firm.

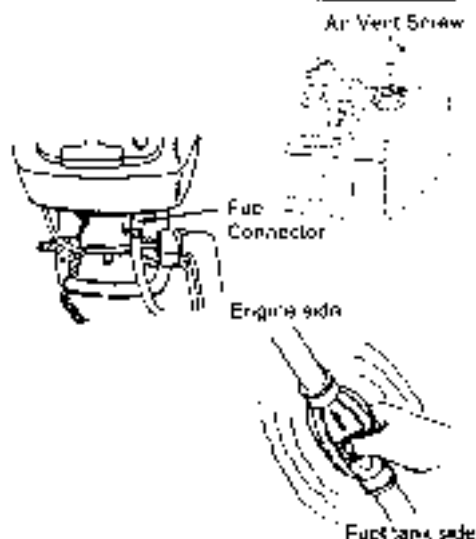

- ④ Be sure to install the stop switch lock to the stop switch.

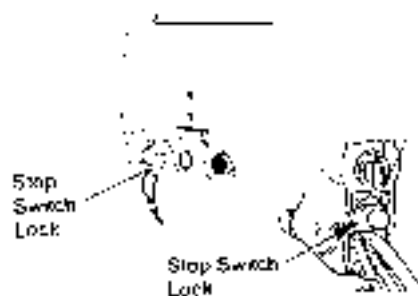

MF and EF type

- ⑤ Place the shift lever in the Neutral position.

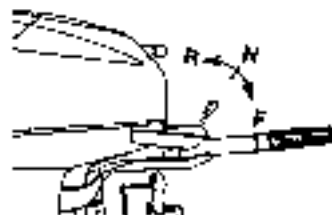

Be sure that the shift is in neutral when starting the engine.
This model is provided with start in gear protection.

▲ CAUTION

If the motor starts in gear, do not use it. Contact your authorized dealer.

- ⑥ Set the throttle grip to "START" position.

Note.

When the engine is warm, set the throttle grip to "RE-START" position.



MF type

Engine is equipped with a compressor release mechanism

- ① Pull the starter handle slowly until you feel engagement. keep pulling till you feel less resistance. Then pull it quickly. Repeat if necessary until started.

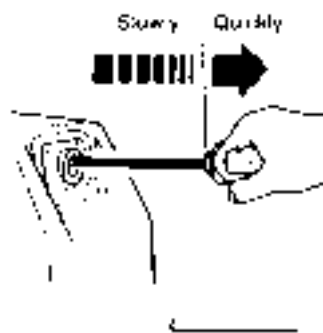

EF type

- ⑦ Push the starter switch button.
- ⑧ Release the button when the engine has started.



EP type

- ⑤ Insert the main switch key.
- ⑥ Set the control lever in the Neutral position. Do not raise the Neutral warm-up lever when starting the engine.
- ⑦ Turn the main switch key to START position.
- ⑧ Release the key when the engine has started. The key returns to the original position automatically.

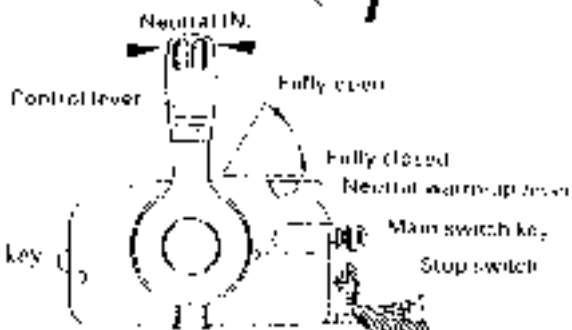

Note:

The neutral warm-up lever can not be raised when the control lever shift is in **Forward** or **Reverse**

If the recoil starter fails to operate

- Remove the upper motor cover and the recoil starter. Wrap a rope around the starter pulley then pull quickly to start.
- Use a 10 mm socket wrench as a rope handle.

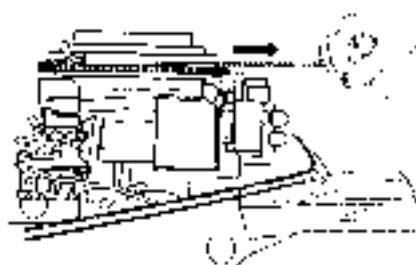

▲ CAUTION

Be careful that your clothes or other items do not get caught in the rotating engine parts.

To prevent accident and injury, do not re-attach the recoil starter after the engine has been started using the emergency starter rope. Be sure to put the upper motor cover back on.

Immediately contact an authorized service shop when reaching shore.

5-2. Warming up the engine

Warm the engine at low engine speeds for about three minutes. This allows the lubricating oil to circulate to all parts of the engine. Operating the engine without warm up shortens the engine's life.

Be sure to check that cooling water is coming out of the cooling water check port during warm up.

▲ CAUTION

If the engine is operated without water discharging from the check port, the engine may over heat.



● Engine speeds

Idling speed after warming up.

Clutch in (In gear)	Clutch off (Out of gear)
900 rpm	1,000 rpm

PROPELLER SELECTION

Propeller must be selected that will allow the engine to reach recommended rpm when cruising at wide open throttle.

Wide-open throttle rpm range	
9.9	15.18
4,500-5,500 rpm	5,000-6,000 rpm

Genuine propellers are listed on PROPELLER TABLE of this manual

5-3. Forward and reverse

CAUTION

Severe damage, and personal injury, may occur if shifting at high engine speed.

Engine must be in the slow idle position before shifting is attempted.

Note:

Do not increase engine speed unnecessarily in reverse.

MF and EF type



(1) Forward

Turn the throttle grip to reduce engine speed. When the engine reaches trolling (or idling) speed, quickly pull the shift lever to the Forward position.

(2) Reverse

Reduce engine speed, when the engine reaches trolling (or idling) speed, quickly push the shift lever to the Reverse position.

EP type

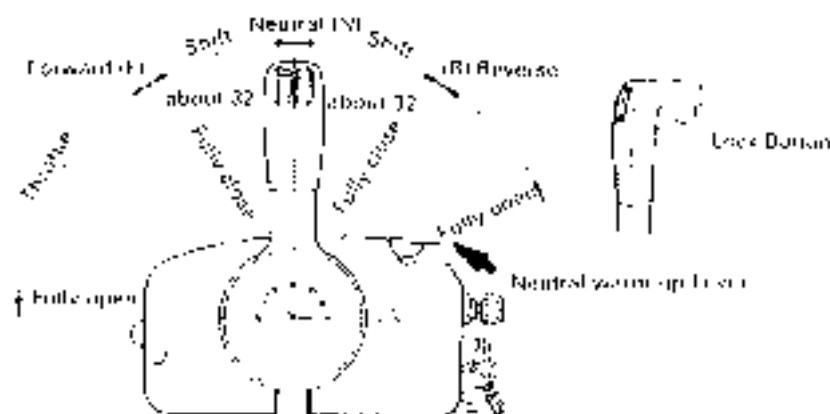

(1) Forward

Quickly push the control lever to the Forward (F) position at 32° where the gear is connected while lifting up on the lock button located at the bottom of the control lever grip. Further shifting will open the throttle.

(2) Reverse

Quickly pull the control lever to the Reverse (R) position at 32° where the gear is connected, while lifting up on the lock button located at the bottom of the control lever grip. Further shifting will open the throttle.

Note:

The control Lever is inoperative unless the Neutral Warm up Lever is in the fully closed position.

Note:

Reduce the engine speed when the Control Lever is in Neutral and do not increase the engine speed unnecessarily.

5-4. Stopping MF and EF type

- ① Turn the throttle grip to the slow position.
- ② Put the shift lever in the Neutral position.
Run the engine for 2 - 3 minutes at idling speed if it has been running at full speed.
- ③ Push the stop switch to stop the engine or release the stop switch lock.

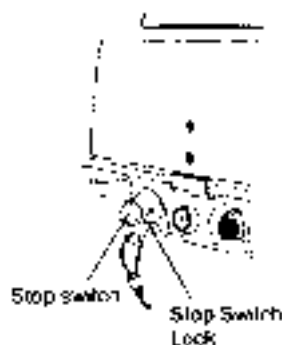

EP type

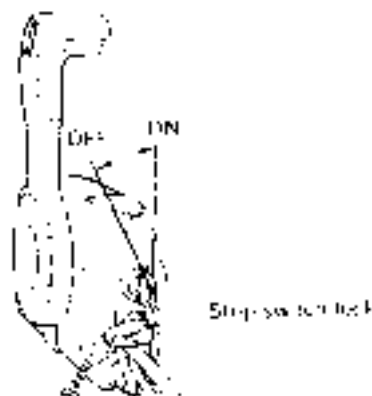

- ① Put the shift lever in the Neutral position and run the engine for 2 - 3 minutes at idling speed if it has been running at full speed.
- ② Turn the main switch key to the OFF position.

Note:

- After stopping the engine, close the air vent screw on the tank cap.
- Disconnect the fuel connector of the engine or the fuel tank.
- Disconnect the battery cord of the EF or EP type engine, if the engine will not be used for more than 3 days.

5-5. Trim angle

The trim angle of the outboard motor can be adjusted to suit the trim angle of the hull, and load conditions. Choose an appropriate trim angle that will allow the anti-ventilation plate to run parallel to the water surface during operation.

● Proper trim angle

The position of the thrust rod is correct if the hull is horizontal during operation (Fig. 1)



● Improper trim angle

Set the thrust rod lower if the bow of the boat rises above horizontal (Fig. 2)



● Improper trim angle

Set the thrust rod higher if the bow of the boat is below horizontal (Fig. 3)

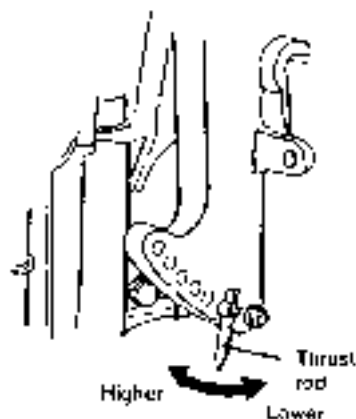

5-6. Tilt up, tilt down

▲ WARNING

When tilting up or down, be careful not to place your hand between the swivel bracket and the stern bracket.
Be sure to tilt the outboard down slowly.

Note:

Stop the engine before tilting up.

(1) Tilt up

Push the reverse lock lever down until it stops. (This is the tilt up position). Now, tilt the engine all the way up until it is locked in place.



(2) Tilt down

Pull the reverse lock lever upward until it stops. (This is the tilt down position.) Now, lift up the engine slightly, and then allow gravity to lower it for you.



Tilt Up

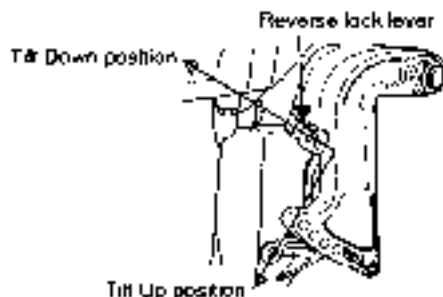

Tilt Down

5-7. Shallow water operation

▲ WARNING

During shallow water operation, be careful not to place your hand between the swivel bracket and the stern bracket.
Be sure to tilt the outboard down slowly.

Note:

Slow down to trolling speed, and shift into Neutral or Forward before shallow water operation.

11) Shallow water running position

Put the reverse lock lever in the tilt up position, and tilt up the engine to put the engine in the shallow water running position.

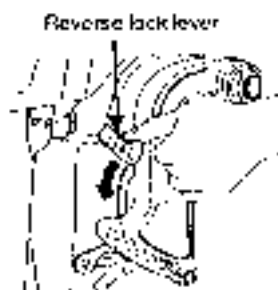

12) Return to normal running position

Put the reverse lock lever in the tilt down position, slightly tilt up the engine, and then put it down.

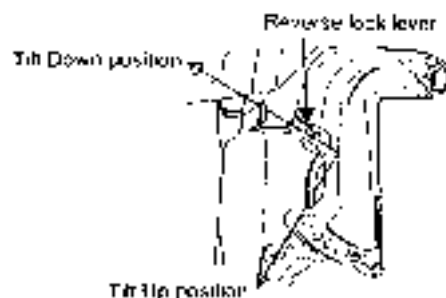

▲ CAUTION

While in shallow water drive position, do not operate the outboard in reverse. Operate the outboard at slow speed and keep the cooling water intake submerged.

6. REMOVING AND CARRYING THE MOTOR

6-1. Removing the motor

- ① Stop the engine
- ② Disconnect the fuel connector, the remote control cables and the battery cords from the motor.
- ③ Remove the motor from boat and completely drain the water from the gear case

6-2. Carrying the motor

Keep the motor in a vertical position when carrying



6-3. Storing the motor

Motor should be stored in a vertical position

Note:

If the engine must be laid down be sure the tiller handle faces down as shown in the drawing above

▲ CAUTION

Never carry, or store, the engine in the positions shown below.

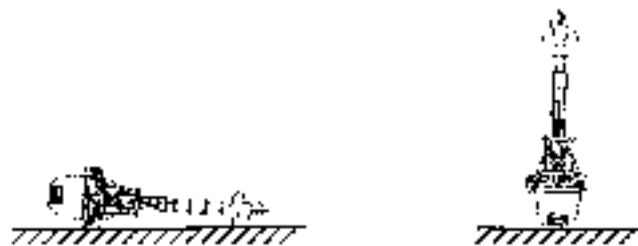

7. TRAILERING

▲ CAUTION

When trailering the engine should be in a vertical (normal running) position, fully down. Trailering in the tilted position may cause damage to the motor, boat, etc.

If trailering with engine fully down is not available (the gear case skeg is too close to the road in a vertical position), fix the motor securely using a device (like a transom sever bar) in the tilted position.



▲ CAUTION

The tilt support device supplied on your outboard is not intended for lowering. It is intended to support the engine while the boat is docked, beached, etc.

8. ADJUSTMENT

8-1. Steering friction

Adjust this lever to achieve the desired steering friction (drag) on the tiller handle. Move lever towards (a) to tighten friction and move lever towards (b) to loosen friction.

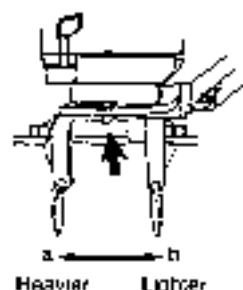

A WARNING

Avoid possible serious injury or death from loss of boat control. Maintain sufficient steering friction to prevent the outboard from steering into a full turn if the tiller handle is released.

8-2. Throttle grip

Friction adjustment of the throttle grip can be made with the throttle adjustment screw.

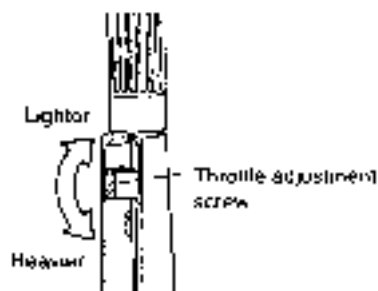

9. INSPECTION AND MAINTENANCE

Care of your outboard motor

To keep your motor in the best operating condition, it is very important that you perform daily and periodic maintenance as suggested in the maintenance schedules that follow.

▲ CAUTION

- Your personal safety and that of your passengers depends on how well you maintain your outboard motor. Carefully observe all of the inspection and maintenance procedures described in this section.
- The maintenance intervals shown in the checklist apply to an outboard motor in normal use. If you use your outboard motor under severe conditions such as frequent full-throttle operation, frequent operation in brackish water, or for commercial use, maintenance should be performed at shorter intervals. If in doubt, consult your dealer for advice.
- We strongly recommend that you use only genuine replacement parts on your outboard motor. Damage to your outboard arising from the use of other than genuine parts is not covered under the warranty.

EPA Emissions Regulations

EPA (United States Environmental Protection Agency) has emission regulations and controlling air pollution from new outboard motors. All new motors manufactured by us are certified to EPA as conforming to the requirements of the regulations. This certification depends upon factory standards. Therefore, factory specifications must be followed when servicing emission related controls, or making adjustments. **Maintenance, replacement, or repair of the emission control devices and systems may be performed by any marine SI (Spark Ignition) engine repair establishment or individual.**

9-1. Daily Inspection

Perform the following checks before and after use.

Item	Points to Check	Action
Fuel System	<ul style="list-style-type: none">● Check the amount of fuel in the tank.● Check for debris or water in the fuel filters.● Check the rubber hoses for fuel leakage	Replenish Clean or Replace Replace
Engine Oil	<ul style="list-style-type: none">● Check the oil level	Fill to the upper level mark on dipstick
Electrical Equipment	<ul style="list-style-type: none">● Check that the main switch functions normally.● Check that the battery electrolyte level and specific gravity are normal.● Check for loose connections on the battery terminal● Check that the lanyard stop switch functions normally and make sure the lock plate is there● Check cords for loose connections and damage.● Check the spark plugs for dirt wear and carbon build-up	Replace Replenish or recharge Retighten Remedy or replace Correct or replace Clean or replace
Throttle System	<ul style="list-style-type: none">● Check carburetor linkage is working normally when turning the throttle grip.	Correct
Recoil Starter	<ul style="list-style-type: none">● Check the rope for wear and chafing● Check the ratchet engagement	Replace Correct or replace
Clutch and Propeller System	<ul style="list-style-type: none">● Check that the clutch engages correctly when operating the shift lever.● Visually check the propeller for bent or damaged blades.● Check that the propeller nut is tightened	Adjust Replace
Installation of Motor	<ul style="list-style-type: none">● Check all the bolts attaching the motor to the boat.● Check the thrust rod installation	Tighten
Cooling Water	<ul style="list-style-type: none">● Check that cooling water is discharged from the cooling water check port after the engine has started	Repair
Tools and Spares	<ul style="list-style-type: none">● Check that there are tools and spare parts for replacing spark plugs, the propeller, etc.● Check that you have the spare rope.	
Steering Device	<ul style="list-style-type: none">● Check the operation of the steering handle	Repair
Other parts	<ul style="list-style-type: none">● Check if the anode is securely installed.● Check the anode for corrosion and deformation.	Repair if necessary Replace

A. Maintaining engine oil

If the engine oil is low, the life of the engine will be shortened significantly.

Checking oil level

- ① Stop the engine and set it in a vertical position.
- ② Remove the upper motor cover.
- ③ Remove the dipstick.
- ④ Wipe oil off the oil dipstick with a clean rag.
- ⑤ Put in the dipstick.
- ⑥ Take out the dipstick and check the oil level.
- ⑦ Replace the dipstick.

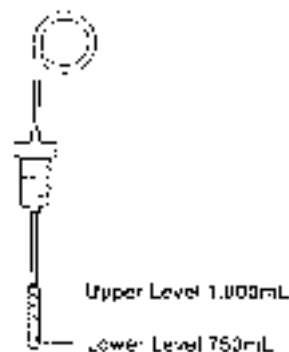

Note:

Consult with your dealer if the engine oil is milky color, or appears contaminated.

Replenishing engine oil:

If the oil level is low, or at lowest mark, add recommended oil to the upper dipstick mark.

▲ CAUTION

- When adding engine oil, use the same brand and same grade oil.
- Be careful not to mix dust and water when adding the engine oil.
- If the oil overflows, wipe it up with rag.

B. Washing

After operating the motor in sea water or polluted water, or if it will be stored for a long period, wash all enclosures and the water cooling system with fresh water.

▲ WARNING

Before flushing, remove the propeller and the forward thrust holder.

▲ WARNING

Never start or operate the engine indoors or in any space which is not well ventilated. Exhaust gas contains carbon monoxide, a colorless and odorless gas which can be fatal if inhaled for any length of time.

Use a flushing attachment.

- ① Remove propeller (refer to Propeller Replacement). Remove the water plug from the motor and screw in the flushing attachment.
- ② Attach a water hose to the flushing attachment. Turn on the water and adjust the flow. (Be sure to seal the water strainer and sub water strainer, located in the gear case, with tape.)
- ③ Start the engine and run it at idle speed in neutral shift position.
- ④ Check for a steady stream of water flowing out of the water pump indicator hole. Continue flushing the outboard for 3 to 5 minutes, carefully monitoring water supply at all times.
- ⑤ Stop the engine, turn off the water, and remove the flushing attachment. Reinstall the propeller.

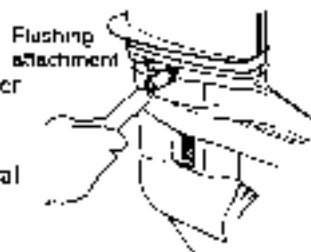

C. Replacing the propeller

A worn-out or bent propeller will lower the motor's performance, and cause engine trouble.

⚠ CAUTION

Before removing the propeller, remove the spark plug caps from the spark plugs to protect against personal injury.

- ① Remove the split pin, propeller nut and washer.
- ② Remove the propeller and thrust holder.
- ③ Apply genuine grease to the propeller shaft before installing a new propeller.
- ④ Install the thrust holder, propeller, washer and propeller nut onto the shaft.
- ⑤ Install a new split pin into the nut hole and bend it.

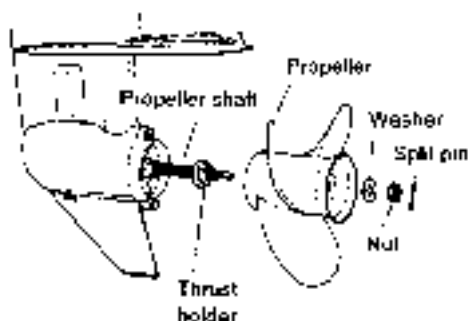

D. Replacing the spark plugs

If the spark plug(s) is fouled, has carbon build up or is worn, it should be replaced.

- ① Stop the engine.
- ② Remove the upper motor cover.
- ③ Remove the spark plug caps.
- ④ Remove the spark plugs by turning it counter-clockwise, using a 16 mm socket wrench and handle.

Use spark plug NGK DCPR-6E

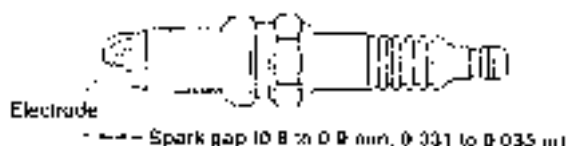

E. Replacing the anode

A sacrificial anode protects the outboard from the galvanic corrosion. Anode is located on the gear case and the exhaust cover. When the anode is corroded more than 2/3, replace it.

Note.

- Never grease or paint the anode.
- At each inspection re-tighten the anode attaching bolt. As it is likely to be subjected to electrolytic corrosion.

9-2. Periodic Inspection

It is important to inspect and maintain your outboard motor regularly. At each interval on the chart below, be sure to perform the indicated servicing. Maintenance intervals should be determined according to the number of hours or number of months, whichever comes first.

Item		Servicing Interval			Action	Remarks
		First 20 hours or 1 month	Every 50 hours or 3 months	Every 100 hours or 6 months		
Fuel System	*Carburetor			○	Service, clean, and adjust.	
	Fuel lines	○	○	○	Check and clean or replace.	
	Piping	○	○	○	Check and replace.	
	Fuel tank	○		○	Clean.	
Ignition	Spark plug	○		○	Check gaps. Remove carbon deposits or replace.	
	*Ignition timing	○		○	Adjust timing.	
Starting System	Starter rope	-	○	○	Check for wear or chafing.	
	*Starter motor			○	Check for salt deposits and the battery cable condition.	
	Battery	○	○	○	Check installation, load capacity, gravity.	
Engine	Engine oil & Oil filter	○		○	Change.	
	Valve Clearance	○		○	Check & adjust.	
	*Timing belt			○	Check and replace if necessary.	
	Propeller	○	○	○	Check for bent blades, damage, wear.	
Lower Unit	Gear oil	Change ○	○	Change ○	Change or replenish oil and check for water leaks.	
	*Water pump		○	○	Check for wear or damage.	Replace impeller every 12 months.
Bolt and Nuts		○	○	○	Tighten.	
Sliding and Rotating Parts: Grease nipples		○	○	○	Apply and pump in grease.	
Cover Equipment		○	○	○	Check for corrosion.	
Anode			○	○	Check for corrosion and deformation.	Replace.

* Have this checked by your dealer.

Note:

Your outboard motor should receive careful, and complete inspection at 300 hours. This is the best time for major maintenance procedures to be carried out.

A. Changing engine oil

Engine oil mixed with dust or water will dramatically shorten the life of the engine.

To change engine oil:

- ① Stop the engine and set it in a tilted position.
- ② Remove the upper motor cover and oil filler cap. Allow it to cool.
- ③ Turn the steering on the outboard so that the drain hole is facing downward.
- ④ Put a oil drain pan under the oil drain screw.
- ⑤ Remove the oil drain screw and completely drain oil from the engine.
- ⑥ Tighten the oil drain screw.
- ⑦ Reset the engine in a vertical position.
- ⑧ Fill the engine through filler port with recommended oil (see chart below) to the upper dipstick mark.
- ⑨ Tighten the oil filler cap.

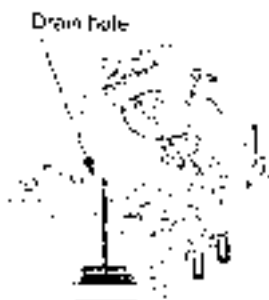

Note!

Recommended engine oil:

4 stroke engine oil

Use SAE 10W-30, 40 or rated SF, 5G, 5H or SJ

Use the proper viscosity oil from the chart below. This chart is based on the atmospheric temperature where the engine will be used.

Oil capacity 1.000 mL

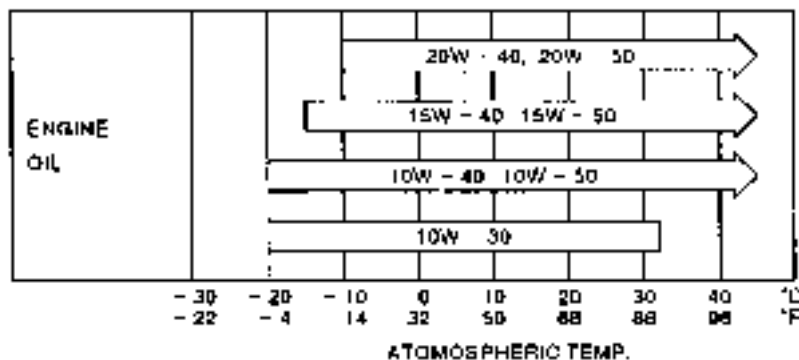

⚠ CAUTION

You may be injured due to high engine temperatures if you fill engine oil just after stopping. Changing engine oil should be done after the engine has been cooled.

Note:

- If water in the oil, giving it a milky colored appearance. Contact your dealer.
- If oil contaminated with fuel (will smell strongly of fuel). Contact your dealer.

B. Changing oil filter

- ① Drain oil from the engine.
- ② Place a rag or towel below the oil filter to absorb any spilled oil.
- ③ Unscrew old filter by turning the filter to the left.
- ④ Clean the mounting base. Apply Film of clean oil to filter gasket. Do not use grease. Screw new filter on until gasket contacts base then tighten $3/4$ to 1 turn.



Oil filter



Oil filter wrench

C. Cleaning the fuel filters and the fuel tank

Fuel filters are provided inside the fuel tank and engine

① Engine filter

Replace the filter provided inside of engine cover if there is water or dirt inside.



② Fuel tank filter

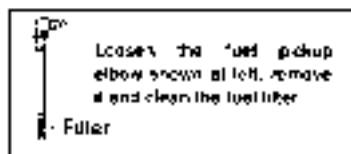

③ Fuel tank

Water or dirt in the fuel tank will cause engine performance problems. Check and clean the tank at specified times or after the motor has been stored for a long period of time (over three months).

D. Changing gear oil

- 1) Remove the oil plugs (upper and lower), and completely drain the gear oil into a pan.

Note:

- If water in the oil, giving it a milky colored appearance. Contact your dealer.



- 2) Insert the oil tube nozzle into the lower oil plug hole and fill with gear oil by squeezing the oil tube until oil flows out of the upper plug hole.



- 3) Install the upper oil plug and then remove oil tube nozzle and install the lower oil plug.



Note:

Use genuine gear oil or the recommended one (API GL-5; SAE #80 to #90).

Required volume: approx. 370 mL.

9-3. Off-season storage

Before you put your outboard motor in storage, it is a good opportunity to have it serviced and prepared by your dealer.

⚠ CAUTION

Before servicing the motor for storage:

- Remove the battery cables.
- Remove the spark plug caps from the spark plugs.
- Do not run the motor out of the water.

A. Engine

- ① Wash the engine exterior and flush the cooling water system thoroughly with fresh water. Drain the water completely.
Wipe off any surface water with an oily rag.
- ② Use a dry cloth to completely wipe off water and salt from the electrical components.
- ③ Drain all fuel from the fuel hoses, fuel pump, and carburetor, and clean these parts.
Keep in mind that if gasoline is kept in the carburetor for a long time, gum and varnish will develop, causing the float valve to stick, restricting the jets.
- ④ Remove the spark plugs and spray storage oil (available from your authorized dealer) into the combustion chamber through the spark plug holes while slowly turning the motor over using the recoil starter.
- ⑤ Change the engine oil.
- ⑥ Change the gear oil in the gear case.
- ⑦ Apply grease to the propeller shaft.
- ⑧ Apply grease to all sliding parts, joints, nuts, and bolts.
- ⑨ Stand the engine up vertically in a dry place.

B. Battery

- ① Disconnect the battery cables.
- ② Wipe off any chemical deposits, dirt, or grease.
- ③ Apply grease to the battery terminals.
- ④ Charge the battery completely before storing it for the winter.
- ⑤ Recharge the battery once a month to prevent it from discharging and the electrolyte from deteriorating.
- ⑥ Store the battery in a dry place.

C. Electric Starter Motor

Coat the pinion gears and the shaft of the electric starter motor with grease.

9-4. Pre-season check

① Check that the shift and throttle function properly.

(Be sure to turn the propeller shaft when checking the shift function or else the shift linkage may be damaged.)

Note:

The following steps must be taken when first using the engine after winter storage.

1. Fill the fuel tank completely with 12 liters.
2. Warm up the engine for 3 minutes in the "NEUTRAL" position.
3. Run the engine for 5 minutes at the slowest speed.
4. Run the engine for 10 minutes at half speed.

In Steps 2 and 3 above, the oil used for storage inside the engine will be flushed out to assure optimum performance.

② Check the electrolyte level, and measure the voltage and specific gravity of the battery.

Specific Gravity at 20 °C	Terminal Voltage (V)	Charge Condition
1.120	10.5	Fully discharged
1.160	11.1	1/4 charged
1.210	11.7	1/2 charged
1.250	12.0	3/4 charged
1.280	13.2	Fully charged

③ Check that the battery is secure and the battery cables are properly installed.

9-5. Motor submerged in water

After taking your motor out of the water, immediately take it to your dealer.

The following are the emergency measures to be taken for a submerged outboard, if you can not take it to your dealer right away.

- 1) Wash the motor with fresh water to remove salt or dirt.
- 2) Remove the engine oil drain screw and completely drain water and oil from the engine.
- 3) Remove the spark plugs, and completely drain the water from the engine by pulling the recoil starter several times.
- 4) Inject a sufficient amount of engine oil through the spark plug holes. Pull the recoil starter several times to circulate the oil throughout the motor.

9-6. Cold weather precautions

If you moor your boat in cold weather at temperatures below 0 °C (32 ° F), there is the danger of water freezing in the cooling water pump, which may damage the pump, impeller, etc. To avoid this problem, submerge the lower half of the engine into the water.

9-7. Checking after striking underwater object

Striking the sea bottom or an underwater object may severely damage the outboard. Immediately bring the outboard to the dealer and ask for the following checks:

- (1) Looseness or damage of power unit installation bolts, gear case and extension case bolts, propeller shaft housing bolts, upper and lower mount rubber bolts, and/or mount bracket bolts.

Ask the dealer to tighten any loose bolts and nuts, and to replace damaged parts.

- (2) Damage to mount rubber, the tilt stopper, thrust rod, gears and clutch, and/or propeller.

Ask the dealer to replace damaged or defective parts.

10. TROUBLESHOOTING

If you encounter a problem, consult the check list below to determine the cause and to take the proper action.

Your dealer will always be happy to provide any assistance and information.

	Engine failing to start	Engine starting but stopping soon	Poor idling	Poor acceleration	Engine speed abnormally high	Engine speed abnormally low	Boat speed low	Overheating of engine	Possible cause
FUEL SYSTEM	•	•							Empty fuel tank
	•	•	•	•		•	•	•	Incorrect connection of fuel system
	•	•	•	•		•	•	•	Air entering fuel line
	•	•	•	•		•	•	•	Deformed or damaged fuel hose
	•	•	•	•		•	•	•	Closed air vent on fuel tank
	•	•	•	•		•	•	•	Clogged fuel filter, fuel pump, or carburetor
			•	•		•	•	•	Use of improper engine oil
	•	•	•	•			•	•	Use of improper gasoline
	•			•					Excessive supply of fuel
	•	•	•	•		•	•	•	Poor carburetor adjustment
	•	•	•	•		•	•	•	Spark plug other than specified
	•	•	•	•		•	•		Wet, soot etc. on spark plug

	Engine failing to start	Engine starting but stopping soon	Poor idling	Poor acceleration	Engine speed abnormally high	Engine speed abnormally low	Boat speed low	Overheating of engine	Possible cause
ELECTRIC SYSTEMS	•	•	•	•		•	•		No spark or weak spark
	•								Short circuit of engine stop switch
	•		•	•		•	•		Ignition timing incorrect
	•								Lock plate not timed
	•								Disconnection of wire or loose ground connection
	•								Blown 20 Amp fuse in the starting circuit
	•								Not shifted to neutral position
	•								Weak battery or battery connections are loose or corroded
	•								Ignition key switch failure
	•								Wiring or electrical connection faulty
	•								Starter motor or starter solenoid failure
COMPRESSION SYSTEMS		•	•	•		•	•		Low compression
			•					•	Carbon deposits in the combustion chamber
				•			•		Incorrect valve clearance
								•	Low oil pressure level

	Engine failing to start	Engine starting but stopping soon	Poor idling	Poor acceleration	Engine speed abnormally high	Engine speed abnormally low	Engine speed low	Overheating of engine	Possible cause
OTHERS	•		•	•		•			Incorrect adjustment of throttle link
						•	•		Insufficient cooling water flow clogged or defective pump
			•				•		Faulty thermostat
				•	•		•		Cavitation or ventilation
				•	•	•	•		Incorrect propeller selection
			•	•	•	•	•		Damaged and bent propeller
				•	•		•		Improper thrust red position
				•	•	•	•		Unbalanced load on boat
			•	•	•	•		Transom too high or too low	

11. TOOL KIT AND SPARE PARTS

The following is a list of the tools and spare parts provided with the motor.

Items		Quantity	Dimensions	
Service tools	Tool bag	1		
	Pliers	1		
	Socket wrench	1	10 x 13 mm	
	Socket wrench	1	16 mm	
	Socket wrench handle	1		
	Screwdrivers	1	Cross- and straight-point	
	Screwdriver handle	1		
Spare parts	Starter rope	1	1,000 mm	
	Spark plug	1	NGK DCPR6E	
	Split pin	1		
Parts Packaged with Engine	Fuel tank	1		12L
	Primer bulb	1 set		
	Remote control box	1 set		EP only
	Remote control attachment	1 set		EP only

12. OPTIONAL ACCESSORIES

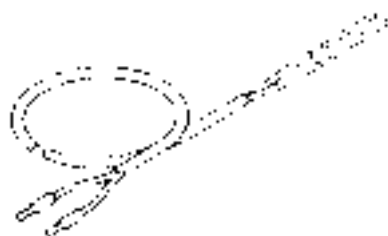

Extension cord for night lights are available on the market.



Genuine grease
(250g)



Genuine gear oil
(500ml)



Touch up paint
(300ml)



Flushing attachment

13. PROPELLER TABLE

Use a genuine propeller.

A propeller must be selected so that the engine rpm measured at wide open throttle while cruising is within the recommended range.

9.9 4,500 to 5,500 rpm

15 5,000 to 6,000 rpm

18 5,000 to 6,000 rpm

	Propeller Mark	Propeller Size Diameter × pitch	Standard propeller on the model		
			9.9	15	18
Light boats	10	9.2 × 9.8 inch		S	S
		234 × 250 mm			
	9	9.2 × 9.1 inch	S	L	L
		234 × 231 mm			
	8.5	8.2 × 8.8 inch	L		
		234 × 224 mm			
	8	8.2 × 7.8 inch			
		234 × 199 mm			
	7	8.2 × 6.9 inch			
		234 × 174 mm			
6	8.2 × 6.1 inch				
	234 × 155 mm				

S (Short), L (long) : Transom height

14. WIRING DIAGRAM

MF type



Note: Including optional parts in the diagram.

EF type

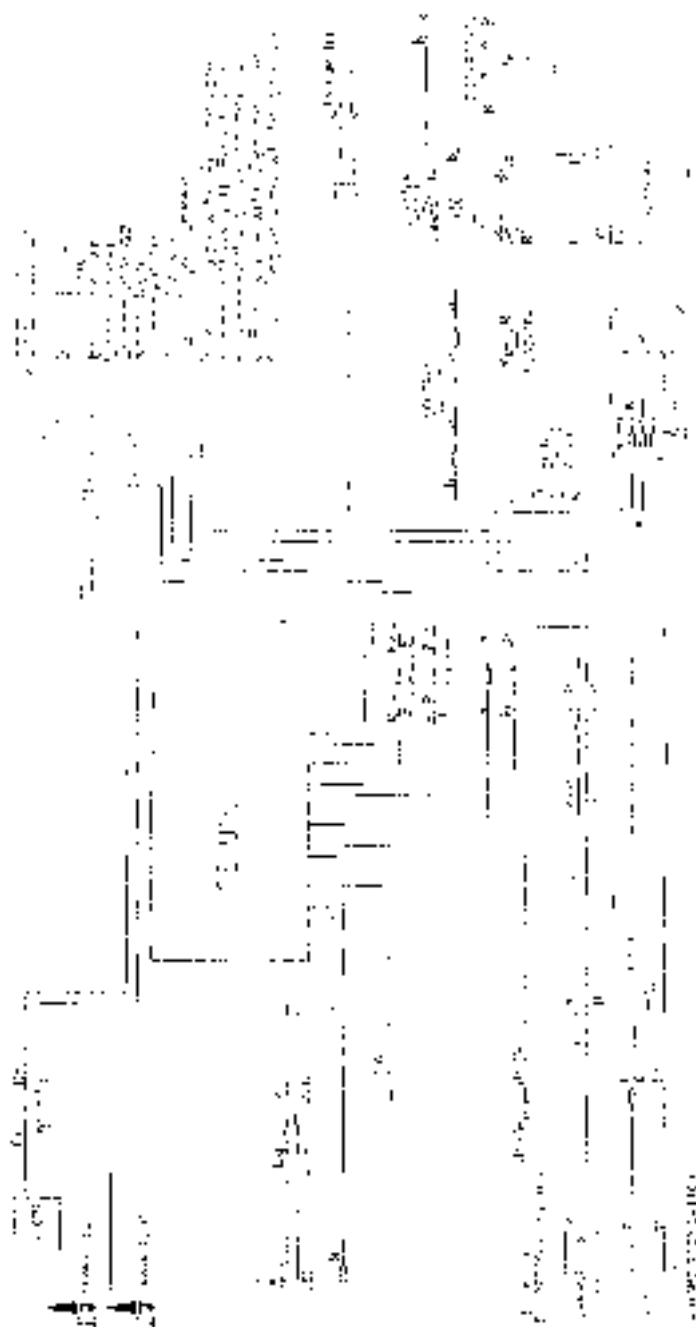

Note: Including optional parts in the diagram

EP type



Note: Including optional parts in the diagram.

NISSAN