



Environmentally friendly technology

## OPERATOR'S MANUAL

### PROPANE POWERED OUTBOARD MARINE ENGINE



## 9.9 HP MODELS:

- LP9.9 S
- LP9.9 L
- LP9.9 ES
- LP9.9 EL
- LP9.9 ERS
- LP9.9 ERL

CAUTION: BEFORE OPERATING THIS PRODUCT, READ AND FOLLOW ALL SAFETY RULES AND OPERATING INSTRUCTIONS.

### TABLE OF CONTENTS

Important Manual Information.....	1
General Information.....	2
Installation.....	7
Operation.....	8
Maintenance.....	13
Troubleshooting.....	21
Specifications.....	24
Warranty.....	25

### FOR SERVICE

Call 1-866-941-LEHR (5347)



#### WARNING:

THIS PRODUCT CONTAINS CHEMICALS KNOWN TO THE STATE OF CALIFORNIA TO CAUSE CANCER, BIRTH DEFECTS OR OTHER REPRODUCTIVE HARM.

# UNDERSTANDING PROPANE

## SAFETY WARNINGS FOR PROPANE UNITS

**NOTE:** Use propane only in tanks specifically designed and approved for this unit. Propane is a combustible gas, it is colorless and thus invisible to the naked eye. Propane has a harmless odorant added so that it is possible to smell it. The user should be familiar with the smell of propane (smells like sulfur or rotten eggs). If at any time the smell of propane is identified, turn off the engine. If the leak persists, remove the propane tank. Never attempt to operate a unit that has a suspected leak. Always remove the propane tank from any unit that has a suspected leak.

## CARBON MONOXIDE HAZARD

Burning propane makes Carbon Monoxide (CO). CO is invisible, has no smell and can kill you. Operating your outboard engine in an enclosed area can be dangerous.

1. Use only in well ventilated areas. If you experience headache, drowsiness, or nausea, turn unit off and get fresh air quickly.
2. Never use where people are sleeping.
3. Follow unit instructions for proper use.

## HANDLING & STORAGE OF PROPANE TANKS

1. Keep out of reach of children.
2. Never expose to heat, sparks, or flame.
3. Never store in direct sunlight.
4. Never store at temperatures above 120 degrees F° (49° C).
5. Never store in living spaces.
6. Always use tank until it is completely empty.
7. Never store in luggage or take on trains or aircraft.
8. To discard, contact local refuse hauler or recycle center.
9. Never put in fire or incinerator. Do not puncture.

## NOTE: FIRE/EXPLOSION HAZARD

Propane tanks contain enough gas to cause serious fire, explosion, and burns. To reduce chance of leak, fire, or explosion, take the following precautions:

## BEFORE USE

1. Check tank and hose seals. Never use with damaged or missing seals. Clean tank if dirt or rust particles are in valve area.
2. Attach tanks outdoors away from pilot lights, flames, sparks or other ignition sources. These sources can ignite leaking gas.
4. Hand tighten only. Never use tools to tighten. Over tightening can damage seals.
5. Check for leaks. Put soapy water on connections. Look for bubbles. Listen for hiss of escaping gas. Feel for extreme cold. Smell for rotten egg odor. Do not use if leaking.
6. Read and follow operation instructions.

## DURING USE

Never use near pilot lights, flames, sparks, or other ignition sources. They can ignite leaking gas.

## AFTER USE

1. Turn engine off and let cool.
2. Detach tank when not in use.
3. Detach outdoors away from pilot lights, flames, sparks, or other ignition sources, they can ignite leaking gas.
4. Replace valve and connector caps to keep them clean.

## IN CASE OF FIRE

1. Leave area quickly and call for help.
2. Let the tank burn out.



### WARNING:

PROPANE IS HIGHLY FLAMMABLE, AND ITS VAPORS CAN EXPLODE IF IGNITED.

# IMPORTANT MANUAL INFORMATION

## TO THE OWNER

Congratulations for purchasing a LEHR propane outboard motor. Thank you for taking the initiative to reduce pollution in our water, air and environment, by changing to an environmentally friendly fuel source for your outboard motor. This operator's manual explains information needed for proper operation, maintenance, and care of your LEHR propane outboard engine. Understanding and following these instructions will help you get the most trouble free use from your LEHR propane outboard. If you have any questions about operation or maintenance of your outboard motor please contact LEHR at 1-866-941-LEHR (5347).

## READ THE OPERATOR'S MANUAL BEFORE OPERATING YOUR LEHR PROPANE OUTBOARD MOTOR

- Read this manual completely and understand the operating procedures before operating the outboard motor.
- Read all manuals supplied with your boat.
- Read all labels on the outboard motor and the boat.
- If you need any additional information, contact your LEHR dealer or call 1-866-941-LEHR (5347).



 WARNING

## WARNING SYMBOLS

Warning symbols indicate: ATTENTION! YOUR SAFETY IS INVOLVED! Failure to follow WARNING instructions could result in severe injury or death to the machine operator, a bystander, or a person inspecting or repairing the outboard motor.

## NOTE

A "NOTE" provides information to make procedures easier or clearer. To ensure long product life, LEHR recommends that you use the product and perform the specified periodic inspections and maintenance by correctly following the instructions in the operator's manual. Note that if you do not follow these instructions, not only may the product malfunction, but the warranty will also be voided.

This product is covered under one or more of the following U.S. Patents:  
7424886 B1, 7631636 B2, 7730868 B2, 7690347 B2, 7739996 B2, 7874275 B1, 7854219 B2, 7735464 B2.  
Other Patents Pending.

## GENERAL INFORMATION

- Before mounting or operating the outboard motor, completely read the operator's manual and labels. Reading them will give you a good understanding of the motor and its operation.
- Before operating the boat, read any owner's or operator's manuals supplied with it and all labels. Be sure you understand all items from the boat manual as well as this engine manual before operating.
- Do not over power the boat with this outboard motor. Overpowering the boat could result in damage to the boat and injury to all occupants. The rated power of the outboard should be equal to or less than the rated horsepower capacity of the boat. If the rated horsepower capacity of the boat is unknown, consult the dealer or boat manufacturer.
- Do not attempt to modify the outboard. Modifications could make the motor unsafe to use and will void the warranty. Incorrect propeller selection and incorrect use may not only cause engine damage, but also adversely affect fuel consumption. Consult your dealer for correct use.
- Never operate after drinking alcohol or taking drugs. About 50% of all boating fatalities involve intoxication.
- Have an approved personal flotation device (PFD) on board for every occupant. It is a good idea to wear a PFD whenever boating. Children and non-swimmers should always wear PFD's, and every one should wear PFD's when there are potentially hazardous boating conditions.
- Propane is highly flammable, and its vapors are flammable and explosive. Handle and store propane carefully. Make sure there are no fumes or leaking fuel before starting the engine.
- This product emits exhaust gases which contain carbon monoxide, a colorless, odorless gas which may cause brain damage or death when inhaled. Symptoms include nausea, dizziness, and drowsiness. Keep cockpit and cabin areas well ventilated. Avoid blocking exhaust outlets.
- Check throttle, shift, and steering for proper operation before starting the engine.
- Attach the engine stop switch lanyard cord to a secure place on your clothing, or your arm or leg while operating. If you accidentally leave the helm, the cord will pull from the switch, stopping the engine.
- Know the marine laws and regulations where you will be boating and obey them.
- Know about the weather forecast. Check weather before boating. Avoid boating in hazardous weather.
- Tell some one where you are going. Leave a Float Plan with a responsible person. Be sure to cancel the Float Plan when you return.
- Be aware, alert, and use good judgment when boating. Know your abilities, and be familiar with how your boat handles under the different boating conditions you may encounter. Operate within your limits, and the limits of your boat. Always operate at safe speeds, and watch carefully for obstacles and other traffic.
- Always watch carefully for swimmers.
- Stay away from swimming areas.
- When a swimmer is in the water near you shift into neutral and shut off the engine.
- Do not illegally discard empty containers used to replace or replenish oil. For the correct processing of empty containers, consult the dealer where you purchased the oil.
- When replacing oils used to lubricate the product (engine or gear oil), be sure to wipe away any spilled oil. Never pour oil without using a funnel or similar device. If necessary, verify the necessary replacement procedure with the dealer.
- Never illegally discard (dump) propane tanks. Consult your local city recycling center on discarding empty propane tanks.

# GENERAL INFORMATION

## BASIC COMPONENTS

NOTE: All components may not be exactly as shown, also may not be included as standard equipment on all models.

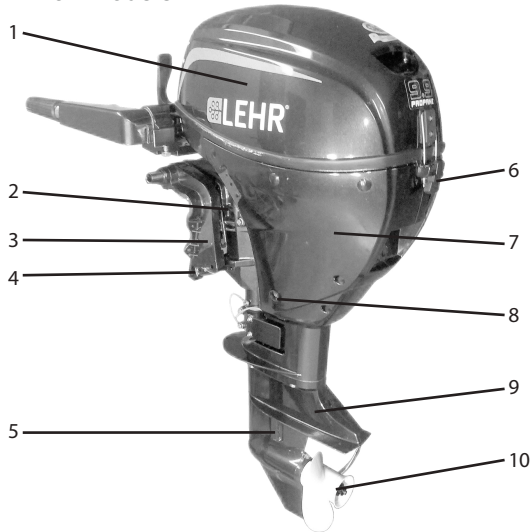

1. TOP COWLING
2. SWIVEL BRACKET
3. CLAMP BRACKET
4. TRIM ROD
5. COOLANT WATER INTAKE
6. TOP COWLING LOCK LEVER
7. LOWER COWLING
8. OIL OUTLET
9. LOWER UNIT HOUSING
10. PROPELLER



11. COOLANT WATER PILOT HOLE
12. TILT LOCK LEVER
13. PULL START HANDLE
14. GEAR SHIFT LEVER
15. TILLER HANDLE
16. ENGINE STOP BUTTON
17. LOW OIL PRESSURE WARNING LIGHT
18. PROPANE CONNECTOR
19. ENGINE RESTRAINT CABLE MOUNT
20. TRANSOM CLAMP HANDLE

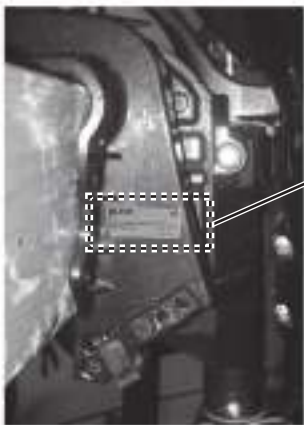

SERIAL NUMBER

LP9.9S12A1234

MODEL	YEAR	MONTH	SEQUENCE PER MONTH
	EX: 12 = 2012	EX: A = JANUARY B = FEBRUARY C = MARCH	

The outboard motor serial number is stamped on the label attached to the clamp bracket. Record your outboard motor serial number, you will need it when ordering spare parts from your LEHR dealer or for reference if your outboard motor is stolen.



EMISSIONS LABEL



- WARNING LABELS:
- DETACH FUEL LINE WHEN NOT IN USE
  - USE ONLY PROPANE MOTOR FUEL
  - FIRE HAZARD

# GENERAL INFORMATION

## PROPANE TANK

Use of a LEHR Liquid Draw propane tank is recommended. A DOT approved propane tank may be used, however extended use at high RPM may result slowed engine performance. Connect the tank to the remote propane connector with the provided high pressure propane hose.

NOTE: Do not use a hose assembly that includes a pressure regulator.



LEHR LIQUID DRAW PROPANE TANK

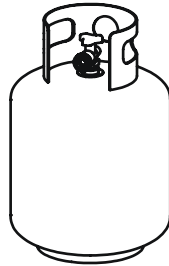

STANDARD 20 lb. PROPANE TANK



HIGH PRESSURE PROPANE HOSE

## TILLER HANDLE

To change direction while operating your boat, move the tiller handle to the left or right as necessary.

TILLER HANDLE



## GEAR SHIFT LEVER

Your outboard has three gear shift positions to provide operation: Forward(F), Neutral(N), and Reverse(R). Reduce throttle speed to idle speed before shifting. Always shift outboard into gear with a quick motion.

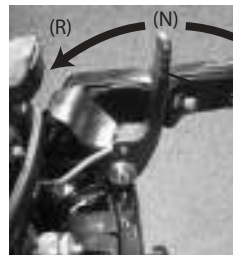

GEAR SHIFT LEVER

## THROTTLE GRIP

The throttle grip is on the tiller handle. Turn the grip counterclockwise to increase speed and clockwise to decrease speed.



THROTTLE GRIP

## THROTTLE FRICTION ADJUSTER

A friction device provides adjustable resistance to movement of the throttle grip or the remote control lever, and can be set according to operator preference. To increase resistance, turn the adjuster clockwise. To decrease resistance, turn the adjuster counterclockwise.



THROTTLE FRICTION ADJUSTER

# GENERAL INFORMATION

**⚠ WARNING:** Do not overtighten the throttle friction adjuster. If there is too much resistance, it could be difficult to move throttle lever or grip, which could result in an accident. When constant speed is desired, tighten the adjuster just enough to maintain the desired throttle setting.

## ENGINE STOP SWITCH

The stop switch lock must be attached to the engine stop switch for the engine to run. The hook should be attached to a secure place on the operators clothing, or arm or leg. Should the operator fall over board or leave the helm, the hook will pull out the stop switch lock, stopping ignition to the engine. This will prevent the boat from running away under power.

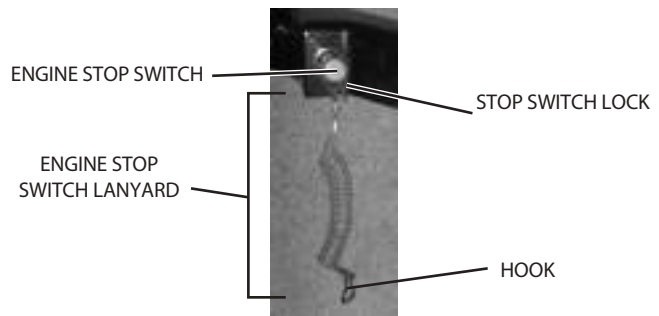

**⚠ WARNING:** Attach the engine stop switch hook to a secure place on your clothing, or your arm or leg while operating. Do not attach the hook to clothing that could tear loose. Do not route the lanyard where it could become entangled, preventing it from functioning. Avoid accidentally pulling the lanyard during normal operation. Loss of engine power means the loss of most steering control. Also, without engine power, the boat could slow rapidly. This could cause people and objects in the boat to be thrown forward.

**NOTE:** The engine cannot be started with the stop switch lock removed.

## ENGINE STOP BUTTON

To stop the engine, push and hold the engine stop switch button or pull the lanyard out from the switch.

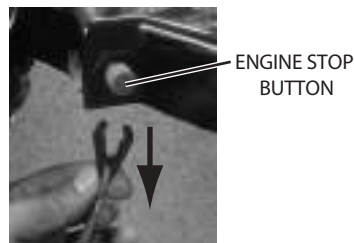

## MANUAL STARTER HANDLE

To start the engine, first gently pull the handle out until resistance is felt. From that position, then pull the handle straight out quickly to crank the engine.

**NOTE:** If the shift lever is not in the neutral position the starter rope will be locked and cannot be pulled

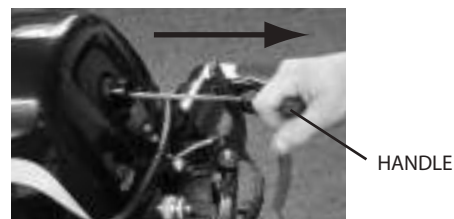

## STEERING FRICTION ADJUSTER

A friction device provides adjustable resistance to the steering mechanism, and can be set according to operator preference. An adjusting screw or bolt is located on the swivel bracket.

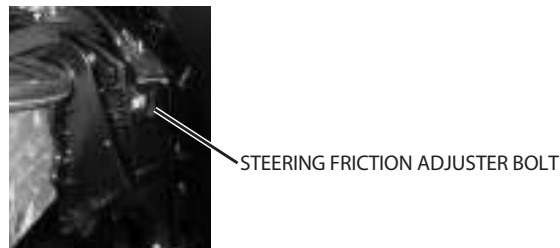

To increase resistance, turn the adjuster bolt clockwise. To decrease resistance, turn the adjuster bolt counterclockwise.

**⚠ WARNING:** Do not overtighten the friction adjuster. If there is too much resistance, it could be difficult to steer, which could result in an accident.

# GENERAL INFORMATION

## TRIM ROD

The position of the trim rod determines the angle of the outboard motor in relation to the transom.

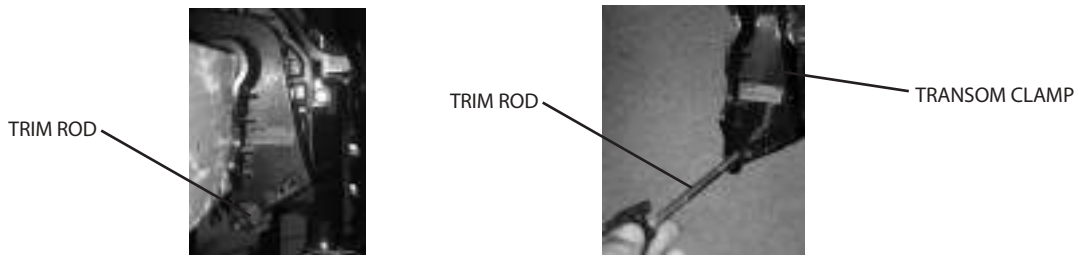

## TILT LOCK MECHANISM

The tilt support lock keeps the outboard motor in the tilted up position. If the outboard engine needs to be tilted up out of the water or to get the propeller higher than the bottom of the boat, unlock the tilt lock mechanism as shown and tilt the engine upwards. Once the engine is all the way up, the tilt lock mechanism will engage and lock the engine in the up position. To release the lock to lower the engine pull up on the rear carrying handle to lift the engine up as far as it will go. While the engine is all the way up, turn the lock lever to the lock position to disengage it while lowering the engine.



**⚠ WARNING:** Do not use the tilt support bar when trailering the boat. The outboard motor could shake loose from the tilt support and fall. If the motor cannot be trailered in the normal running position, use an additional support device to secure it in the tilt position.

## TOP COVER LOCK LEVER

Pull the lock lever upwards from the bottom and unhook from the top cover. Then lift the cover from the rear and remove from the front hook. When installing the cover, make sure the front hook is securely inserted in its slot, then lock the rear lever into place. Check to be sure the rubber seal fits properly on the lower cowling. Then lock the cover by moving the lever downward.



## CARRYING HANDLES

Carrying handles are provided on the front and rear of the outboard motor. The handles enable you to carry the outboard motor easily with two hands.





## INSTALLATION

Incorrect engine height or obstructions to smooth water flow in front of the propeller can cause propeller cavitation while the boat is cruising. Cavitation occurs when the engine speeds up momentarily and suddenly slows as the propeller engages the water. Severe engine damage may result if the motor is operated continuously while cavitating. During water testing check the buoyancy of the boat, at rest, with its maximum load. Check that the static water level on the exhaust housing is low enough to prevent water entry into the power head, when water rises due to waves when the outboard is not running.

## MOUNTING THE OUTBOARD MOTOR

- Overpowering a boat could cause severe instability. Do not install an outboard motor with more horsepower than the maximum rating on the capacity plate of the boat. If the boat does not have a capacity plate, consult the boat manufacturer.
- This section is intended as reference only. It is not possible to provide complete instructions for every possible boat and motor combination. Proper mounting depends in part on experience and the specific boat and motor combination. Improper mounting of the outboard motor could result in hazardous conditions, or poor handling, loss of control, or boat damage.
- Your dealer or other person experienced in proper outboard motor mountings should show you how to mount your motor. Mount the outboard motor on the center line (keel line) of the boat, and ensure that the boat itself is well balanced. Otherwise the boat will be hard to steer. For boats without a keel or which are asymmetrical, consult your dealer.

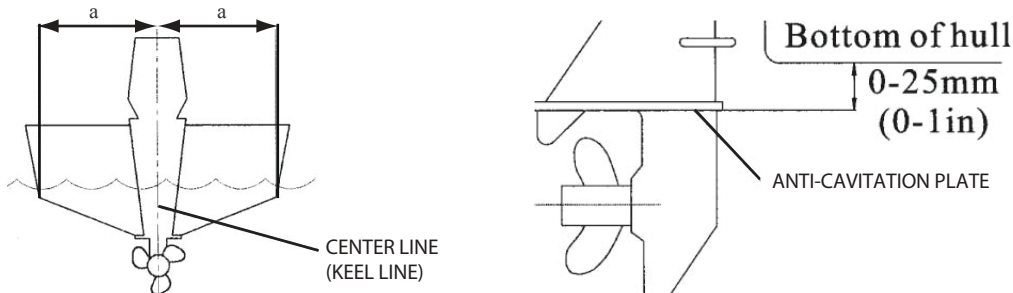

## MOUNTING HEIGHT

To run your boat at best efficiency, the water resistance (drag) of the boat and outboard motor must be made as little as possible. The mounting height of the outboard motor greatly affects the water resistance. If the mounting height is too high, cavitation tends to occur, thus reducing the propulsion, and if the propeller tips cut the air, the engine speed will rise abnormally and cause the engine to over heat. If the mounting height is too low, the water resistance will increase and thereby reduce engine efficiency. Mount the outboard motor so that the anti-cavitation plate is between the bottom of the boat and a level 25mm (1 in.) below it.

The optimum mounting height of the outboard motor is affected by the boat and motor combination and the desired use. Test runs at different heights can help determine the optimum mounting height. Consult your boat manufacturer for further information on determining the proper mounting height.

## CLAMPING THE OUTBOARD MOTOR

1. Place the outboard motor on the transom so that it is positioned as close to the center as possible. Tighten the transom clamp screws evenly and securely. Occasionally check the clamp screws for tightness during operation of the outboard motor because they could become loose due to engine vibration.

**⚠ WARNING:** Loose clamp screws could allow the outboard motor to fall off or move on the transom. This could cause loss of control and serious injury. Make sure the transom screws are tightened securely. Occasionally check the screws for tightness during operation.

2. If an engine restraint cable or chain attachment is equipped on your boat, the cable or chain should be used. Attach one end of the engine restraint cable attachment to the engine clamp and the other to a secure mounting point on the boat. Otherwise the engine could be completely lost if it accidentally falls off the transom.



ATTACH ONE END OF THE RESTRAINT CABLE THROUGH THIS CLAMP MOUNT AND ONE END SECURELY ON THE BOAT

# OPERATION

## PRE-OPERATION CHECKS

**⚠WARNING:** If anything in the pre-operation check is not working properly, have it inspected and repaired before operating the outboard motor. Failure to do so could result in an accident.

## CONTROLS

- Check throttle, shift, and steering for proper operation before starting the engine.
- The controls should work smoothly, without binding or unusual free play.
- Look for loose or damaged connections.
- Check operation of the starter and stop switches when the outboard motor is in the water.
- If the engine has not been used in some time, rev it in neutral to be sure it returns to idle before putting it in gear.

## ENGINE

- Check the engine and engine mounting.
- Look for loose or damaged fasteners.
- Check the propeller for damage.

## CHECKING THE ENGINE OIL LEVEL

1. Put the outboard motor in an upright position (not tilted).
2. Insert the oil dipstick all the way in. Pull it out and check the oil level using the oil dipstick to be sure the level falls between the upper and lower marks. Fill with oil if it is below the lower mark, or drain to the specified level if it is above the upper mark.



Recommended engine oil:  
Use a quality 4-stroke motor oil.

Engine oil type:  
10W-30

Engine oil quantity:  
0.80 US qt (0.8L)

**⚠WARNING: ALL ENGINES ARE SHIPPED FROM THE FACTORY WITHOUT ENGINE OIL. ADD OIL BEFORE STARTING ENGINE.**

## FUEL

- Use a LEHR Liquid Draw propane tank or any DOT approved propane tank.
- Check to be sure you have plenty of fuel for your trip.
- Make sure there are no fuel leaks or propane fumes.

## REFUELING INSTRUCTIONS

**⚠WARNING: PROPANE AND ITS VAPORS ARE HIGHLY FLAMMABLE AND EXPLOSIVE!**

- Stop engine before refueling.
- Do not smoke when refueling, and keep away from sparks, flames, or other sources of ignition.
- Refuel in a well-ventilated area.
- Refuel portable fuel tanks off the boat.
- Have your propane tanks refilled or exchanged at a certified propane refueling or exchange center.

## USE THE CORRECT PROPANE TANK

NOTE: Use of a LEHR Liquid Draw tank is recommended.

A standard U.S. 20 lb. DOT approved propane tank may be used, however extended use at high R.P.M. may result in slowed engine performance.

## CONNECTING THE PROPANE TANK

1. Make sure the engine is off and the propane tank is closed.
2. Unscrew the brass connector plug from the propane connector on the engine.



3. Connect the high pressure propane hose to the propane connector by turning the connector on the hose clockwise.



4. Connect the propane hose to the propane tank. The threads that connect to the propane tank are left hand turn.
5. Open the valve on the tank slowly. Opening the valve too quickly could cause the sudden surge of propane to activate a safety flow limiting device within the tank.

NOTE: Use only a high pressure propane hose. Do not use a hose with a regulator attached.

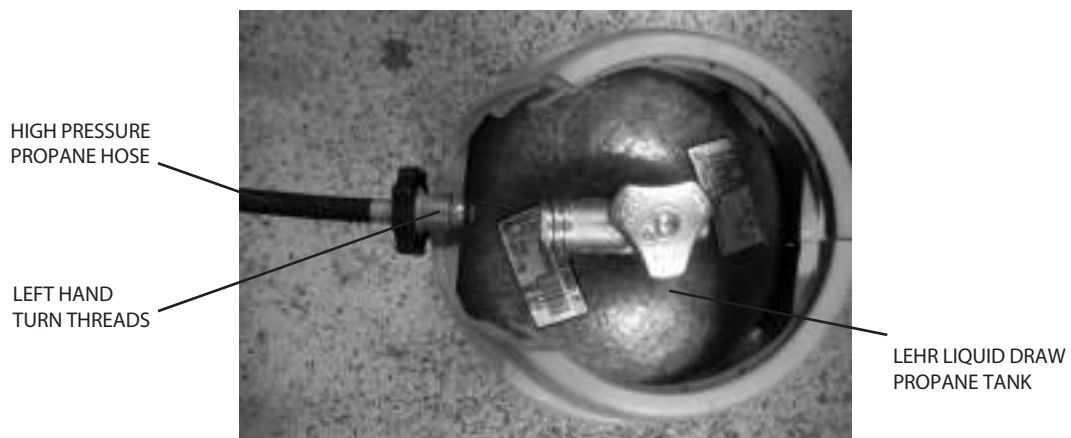

NOTE: When a new hose from a propane tank is being used, it may take a few seconds for the propane to flow to reach the engine. The engine may start and then die, or not start immediately. A few extra pulls of the starter are usually sufficient for the flow to reach the engine.

# OPERATION

## STARTING THE ENGINE

1. Place the gear shift lever in neutral. The engine is equipped with a lockout which will prevent the staterope from being pulled if the engine is engaged in forward or reverse. If your engine is electric start, it will not start if it is engaged in forward or reverse.

**⚠WARNING:** Keep hands, hair, and clothing away from rotating parts while the engine is running. Do not touch or remove electrical parts when starting or during operation.

2. Attach the stop switch lanyard to a secure place on your clothing, or your arm or leg. Then install the stop switch lock on the other end of the lanyard into the engine stop switch.
- Do not attach the lanyard to clothing that could tear loose. Do not route the lanyard where it could become entangled, preventing it from functioning.
  - Avoid accidentally pulling the lanyard during normal operation. Loss of engine power means the loss of most steering control. Also, without engine power, the boat could slow rapidly. This could cause people and objects in the boat to be thrown forward.

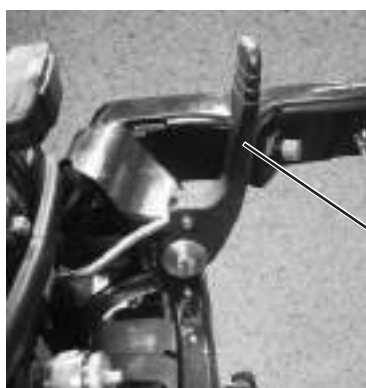

STOP SWITCH LANYARD  
STOP SWITCH LOCK  
ENGINE STOP SWITCH  
GEAR SHIFT LEVER  
(N) NEUTRAL POSITION



3. Place the throttle grip in the "START" position. If the engine is cold, set the position about 1/8 to 1/4 of a turn faster than the "start" or Idle position.
4. Pull the manual starter handle slowly until you feel resistance. Then give a strong pull straight out to start the engine. Repeat if necessary.



START POSITION

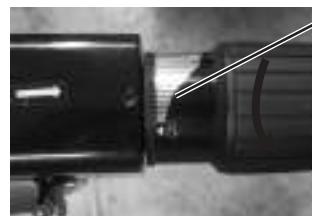

1/8 TO 1/4 THROTTLE

5. After the engine starts, slowly return the manual starter handle to the original position before releasing it.
6. Slowly return the throttle grip to the fully closed position.

**NOTE:** If the engine fails to start after 4 or 5 tries, open the throttle a small amount more (between 1/4 - 1/3 throttle) and try again. Also if the engine is warm and fails to start, open the throttle a small amount and try to start the engine again. If the weather is below 45 degrees F, open the throttle to 1/4 - 1/2 to start cold.

## ELECTRIC START MODELS

Place the gear shift lever in neutral. The engine is equipped with a neutral safety switch, which will prevent the starter to engage if the engine is in gear. Place the throttle in the start position. Press the start button and release after the engine is running.

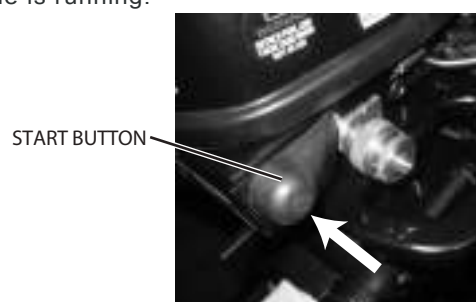

START BUTTON

## WARMING UP ENGINE

1. Warm up the engine by operating at 1/2 throttle or less for the first 4 minutes. Failure to do so may cause the engine to stall in cold weather, and will shorten engine life.
2. Check for a steady flow of water from the cooling water pilot hole.

NOTE: A continuous flow of water from the cooling water pilot hole shows that the water pump is pumping water through the cooling passages. If water is not flowing out of the hole at all times while the engine is running, over heating and serious damage could occur. Stop the engine and check whether the cooling water inlet on the lower case or the cooling water pilot hole is blocked. Consult your dealer if the problem cannot be located and corrected.

COOLING WATER  
PILOT HOLE



## SHIFTING

- ⚠ **WARNING:** Before shifting, make sure no swimmers are in the water near your boat.
  1. Place the throttle in the slowest position.
  2. Move the gear shift lever quickly to the desired gear from neutral to forward or reverse.
- ⚠ **WARNING:** When operating your outboard engine in reverse, go slowly. Do not attempt to open the throttle more than half throttle in reverse. Otherwise your boat can become unstable which can result in loss of control or a possible accident.

## STOPPING ENGINE

1. Push and hold the engine stop button until the engine completely stops.
2. After the engine has stopped disconnect or close the valve on the propane tank.

## ADJUSTING BOAT TRIM

- ⚠ **WARNING:** Stop the engine before adjusting the trim angle. Use care to avoid being pinched when removing the trim rod. Use caution when trying a trim position for the first time. Increase speed gradually and watch for any signs of instability or control problems. Improper trim angle can cause loss of control.

- Tilt the engine up slightly.
- Reposition the rod inside the desired hole.
- To raise the bow ("trim-out"), move the trim rod away from the transom.
- To lower the bow ("trim-in"), move the trim rod closer to the transom.
- Test the boat with the trim set to different angles to find the position that works best for your boat and operating conditions.

TRIM ROD



NOTE: The outboard motor trim angle can be changed approximately 4 degrees by shifting the trim rod one hole.

# OPERATION

When the boat is on plane, a bow-up attitude results in less drag, greater stability and efficiency. This is generally when the keel line of the boat is up about 3 to 5 degrees. With the bow up, the bow of the boat may have a greater tendency to steer to one side or the other. Compensate for this as you steer. The trim tab can also be adjusted to help to help offset this effect. When the bow is down, it is easier to accelerate from a standing start onto plane.

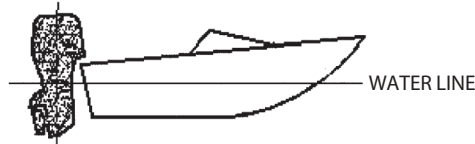

## BOW UP

Too much trim-out puts the bow of the boat too high in the water. Performance and economy are decreased because the hull of the boat is pushing the water and there is more drag. Excessive trim-out can also cause the propeller to ventilate, which reduces performance further, and the boat may "porpoise" (hop in the water) which could throw the operator and passengers overboard.

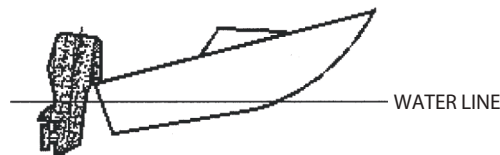

## BOW DOWN

Too much trim-in causes the boat to "plow" through the water, decreasing fuel economy and making it hard to increase speed. Operating with excessive trim-in at higher speeds also makes the boat unstable. Resistance at the bow is greatly increased, heightening the danger of "bow steering" and making operation difficult and dangerous.

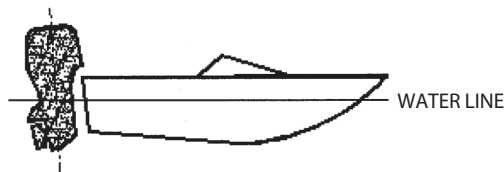

NOTE: Depending on the type of boat, the outboard motor trim angle may have little effect on the trim of the boat when operating.

## TILTING UP AND DOWN

If the engine will be stopped for some time and the boat is moored in shallows, the outboard motor should be tilted up to protect the propeller and casing from damage from collision with obstructions, and also to reduce salt corrosion.

- ⚠ WARNING:** Before tilting the outboard motor, follow the procedure under "Stopping Engine" in this section. Never tilt the outboard motor while the engine is running. Sever damage from overheating can result. Do not tilt the engine by pushing the tiller handle alone because this could break the handle. Hold from the rear of the top cover to help tilt the engine up and down. Keep the power unit higher than the propeller at all times otherwise water could run into the cylinder and cause damage. The outboard motor cannot be tilted while in reverse.

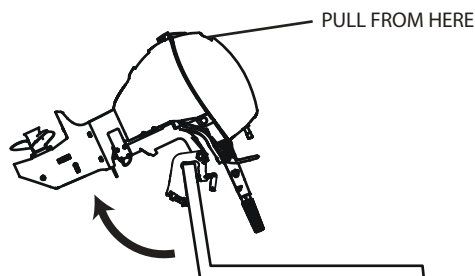

- ⚠ WARNING:** Be sure all people are clear of the outboard motor when tilting up and down, also be careful not to pinch any body parts between the drive unit and engine bracket.

Follow the procedures in "Tilt Lock Mechanism" on pg 6 for tilting the engine up and down instructions.

## TRANSPORTING AND STORING THE OUTBOARD MOTOR

**⚠ WARNING:** Leaking fuel is a fire hazard. When transporting or storing the outboard motor, disconnect the propane connector to prevent the possibility of fuel from leaking. Use care when transporting the fuel tank whether in boat or car.

Never get under the lower unit while it is tilted, even if a motor support bar is used. Severe injury could occur if the outboard motor accidentally falls.

Do not use the tilt support lever when trailering the boat. The outboard motor could shake loose from the tilt support and fall. If the motor can not be trailered in the normal running position, use an additional support device to secure it in the tilt position.

The outboard motor should be trailered and stored in the normal running position. If there is insufficient road clearance in this position, then trailer the outboard motor in the tilt position using a motor support device such as a transom saver bar.

When transporting or storing the outboard motor while removed from a boat, keep the outboard motor in the attitudes shown.

**⚠ WARNING:** This engine weighs at least 88.7 lbs. (40 Kg). Use a hoist or an extra person to help when ever possible when lifting and moving the engine is required.

STORE IN THE UPRIGHT POSITION

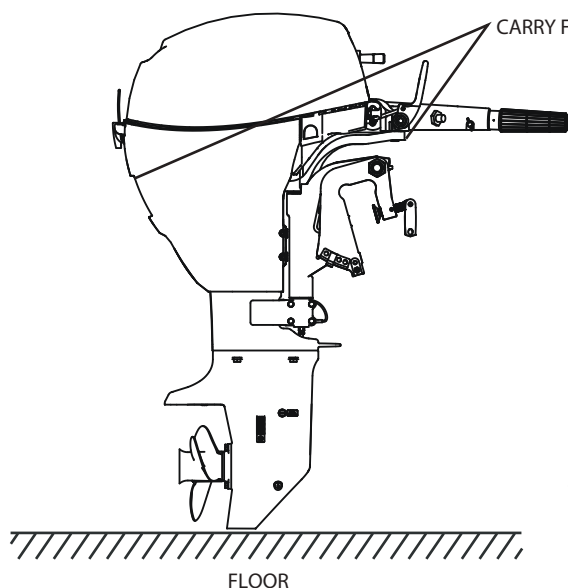

STORE WITH THE TILLER SIDE DOWN

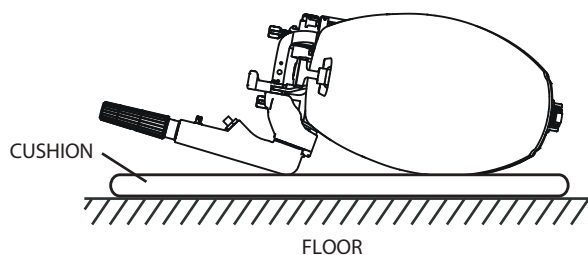

## STORING THE OUTBOARD MOTOR

**NOTE:** Place a towel or something similar under the outboard motor to protect it from damage.

When storing your outboard motor for prolonged periods of time (2 months or longer), several important procedures must be performed to prevent excessive damage.

**NOTE:** Cooling system flushing is essential to prevent the cooling system from clogging up with salt sand, or dirt. In addition, fogging / lubricating of the engine is mandatory to prevent excessive engine damage due to rust. Perform the flushing and fogging at the same time.

- To prevent problems which can be caused by oil entering the cylinder from the sump, keep the outboard motor in the attitude shown when transporting and storing it. If storing or transporting the outboard motor on its side (not upright), put it on a cushion after draining the engine oil.
- Do not place the outboard motor on its side before the cooling water has drained from it completely, otherwise water may enter the cylinder through the exhaust port and cause engine trouble.
- Store the outboard motor in a dry, well ventilated place, not in direct sunlight.

# MAINTENANCE

## PROCEDURE FOR FLUSHING AFTER SEA WATER USE

If the engine has been operated in saltwater, it should always be flushed with fresh water after each use before being stored. Do not run the engine without supplying it with cooling water. Either the engine water pump will be damaged or the engine will be damaged from overheating. Before starting the engine, be sure to supply water to the cooling water passages.

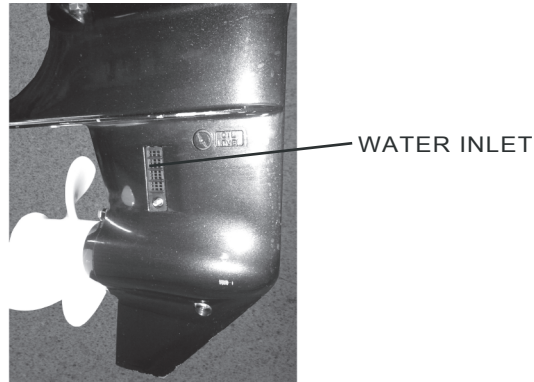

1. Wash the outboard motor body using fresh water.
2. Remove the engine top cowling.
3. Install the outboard motor on a test tank, or submerge the drive in water in some way, as long as the outboard is safely and securely mounted to a solid object.
4. Fill the tank with fresh water to above the level of the anti-cavitation plate. If the freshwater level is below the level of the anti-cavitation plate, or if the water supply is insufficient, engine seizure may occur.
5. Run the engine at a fast idle for a few minutes in neutral position.

**⚠ WARNING:** Never engage forward gear if engine is running when not attached to a boat. An exposed, spinning propeller is dangerous. Even in a tank, the engine can suddenly move when shifted into gear causing the tank or motor to shift and expose the propeller which could result in serious injury.

**NOTE:** Do not touch or remove electrical parts when starting or during operation. Keep hands, hair, and clothes away from the flywheel and other rotating parts while the engine is running.

6. Remove the out board motor from the test tank.
7. Wipe the water off the powerhead. Install the top cowling.
8. Drain the cooling water completely out of the motor. Clean the body thoroughly.

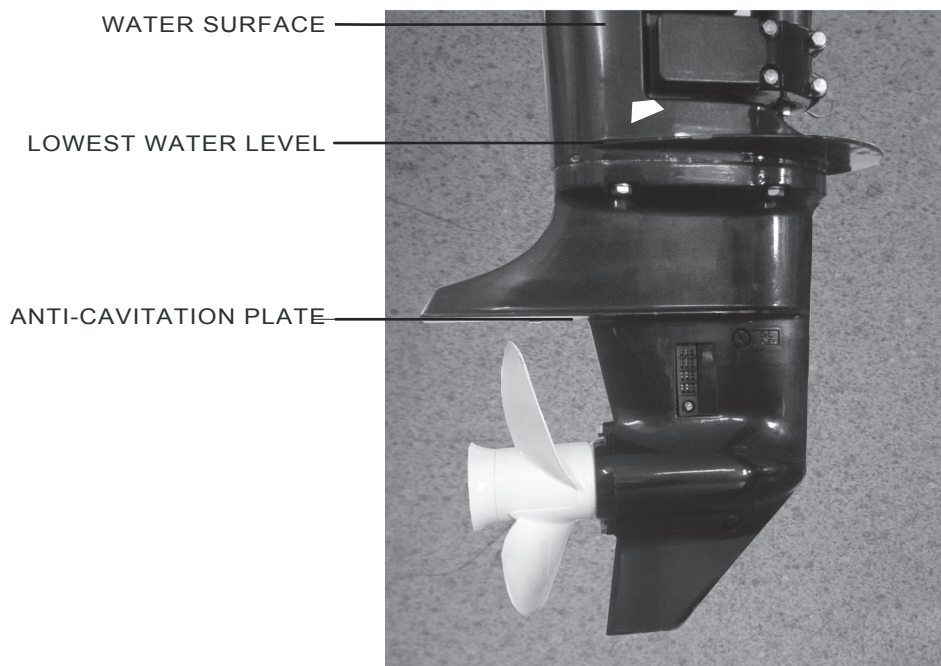



## LUBRICATION

1. Remove the spark plug and spray some fogging oil into the cylinders if the engine will not be operated for several months.
2. Grease the spark plug threads and install the spark plug and torque to proper specification.
3. Change the gear oil. Inspect the oil for the presence of water that indicates a leaky seal.
4. Grease all grease fittings.

## CLEANING THE OUTBOARD MOTOR AFTER USE

1. After use wash the exterior of the outboard motor with fresh water.
2. Flush the cooling system with fresh water.

## CHECKING PAINTED SURFACE OF MOTOR

1. Check the motor for scratches, nicks, or flaking paint. Areas with damaged paint are more likely to corrode. If necessary, clean and paint the areas.

NOTE: Be sure to turn off the engine when you perform maintenance unless otherwise specified. If you or the owner are not familiar with machine servicing, this work should be done by your LEHR dealer or other qualified mechanic.

## REPLACEMENT PARTS

If replacement parts are necessary, use only genuine LEHR parts or parts of the same type and of equivalent strength and materials. Any part of inferior quality may malfunction, and the resulting loss of control could endanger the operator and passengers. LEHR genuine parts and accessories are available from your LEHR dealer, or directly from LEHR.

## MAINTENANCE CHART

Frequency of maintenance operations may be adjusted according to the operating conditions, but the following table gives general guidelines. Refer to the sections in this chapter for explanations of each owner-specification. When operating in salt water or dirty water, the engine should be flushed with clean water after each use.

The “●” symbol indicates the check-ups which you may carry out yourself.  
The “○” symbol indicates work to be carried out by your LEHR dealer.

Item	Actions	Initial		Every	
		10 hours (1 month)	50 hours (3 months)	100 hours (6 months)	200 hours (1 year)
Anodes(s)	Inspection/replacement		● / ○	● / ○	
Cooling water passages	Cleaning		●	●	
Cover clamps	Inspection				●
Fuel system	Inspection	●	●	●	
Gear oil	Change	●		●	
Greasing points	Greasing			●	
Idling speed	Inspection /adjustment	● / ○		● / ○	
Propeller and cotter pin	Inspection/replacement		● / ○	● / ○	
Shift link	Inspection/adjustment				○
Thermostat	Inspection/replacement				○
Throttle link/throttle cable/ throttle	Inspection/adjustment				○
Water pump	Cleaning/adjustment/replacement				○
Engine oil	Inspection/change	●		●	
Spark plug(s)	Inspection/adjustment/replacement		●		●
Valve clearance	Inspection/adjustment	○		○	

# MAINTENANCE

## GREASING

NOTE: Use only water resistant grease.

Grease in these areas:

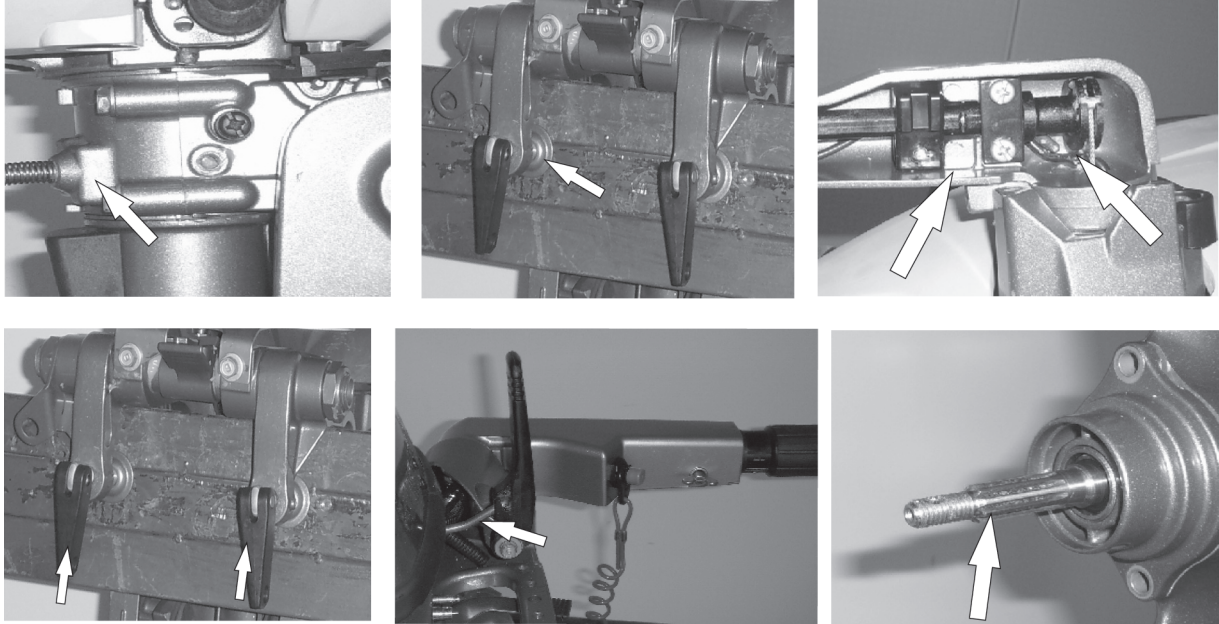

## SPARK PLUGS

**⚠ WARNING:** When removing or installing a spark plug, be careful not to damage the insulator. A damaged insulator could allow external sparks, which could lead to explosion or fire.

The spark plug is an important engine part and is easy to inspect. The condition of the spark plug can indicate the condition of the engine. Normally, the spark plug in a propane engine will stay very clean. Oily or dark color ceramic could indicate a malfunction. Do not attempt to diagnose any problems yourself. Instead, take the outboard motor to a LEHR dealer. You should periodically remove and inspect the spark plug because the electric arcing will cause the spark plug to slowly erode and the gap will increase. If electrode erosion becomes excessive, or if carbon and other deposits are excessive, you should replace the spark plug with another of the correct type.

Before fitting the spark plug, measure the electrode gap with a wire thickness gauge. Adjust the gap to specification if necessary.

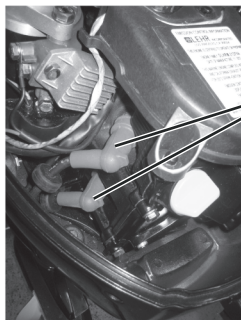

Spark plug Boots

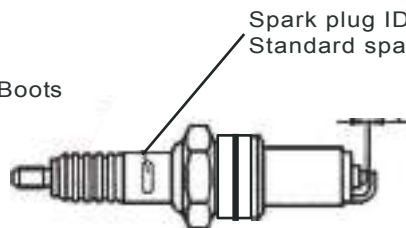

Spark plug ID mark (i.e. NGK)  
Standard spark plug: BR6HS

Spark plug gap:  
0.020-0.024 in (0.5-0.6 mm)

Spark plug torque:  
18.4 ft-lb (25.0 Nm)

When fitting the plug, always clean the gasket surface and use a new gasket. Wipe off any dirt from the threads and screw in the spark plug to the correct torque.

NOTE: If a torque-wrench is not available when you are fitting a spark plug, a good estimate of the correct torque is 1/4 to 1/2 a turn past finger tight. Have the spark plug adjusted to the correct torque as soon as possible with a torque wrench.

## INSPECTION CHECKPOINTS

Periodically check the fuel system for leaks. With the propane tank attached, and the engine cover removed, inspect the following fuel system parts for leakage. Leaks can be identified by smell of propane or carefully listening for a hissing sound of escaping gas. Suspected leaks can be verified by applying soapy water solution on the area and observing bubbles forming.

NOTE: Inspect the following for any source of a fuel leak. A propane sniffing device may be used to inspect.

- Fuel system parts leakage
- Fuel line joint leakage
- Fuel line cracks or other damage
- Fuel connector leakage

## ADJUSTING IDLING SPEED

**⚠ WARNING:** Do not touch or remove electrical parts when starting or during operation. Keep hands, hair, and clothes away from the flywheel and other rotating parts while the engine is running.

**CAUTION:** This procedure must be performed while the outboard motor is in the water. A flushing attachment or test tank can be used.

NOTE: A diagnostic tachometer should be used for this procedure. Results may vary depending on whether testing is conducted with the flushing attachment, in a test tank, or with the outboard motor in the water.

1. Start the engine and allow it to warm up fully in neutral until it is running smoothly.

NOTE: Correct idling speed inspection is only possible if the engine is fully warmed up. If not warmed up fully, the idle speed will measure higher than normal. If you have difficulty verifying the idle speed, or the idle speed requires adjustment, consult a LEHR dealer or other qualified mechanic.

2. Verify whether the idle speed is set to specification ( $1050 \pm 150$  RPM). Adjust the speed by turning the idle speed screw with a phillips head screw driver.

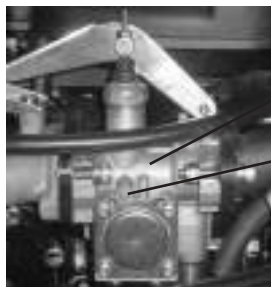

CARBURETOR

IDLE SPEED SCREW

## CHANGING ENGINE OIL

**⚠ WARNING:** Avoid draining the engine oil immediately after stopping the engine. The oil is hot and should be handled with care to avoid burns.

- Be sure the outboard motor is securely fastened to the transom or a stable stand.
- Do not overfill the oil, and be sure the outboard motor is upright (not tilted) when checking and changing the engine oil.
- If the oil level is above the upper level mark, drain until the level meets the specified capacity. Overfilling the oil could cause leakage or damage.
- Change the engine oil after the first 10 hours of operation, and every 100 hours or at 6 month intervals thereafter. Otherwise the engine will wear quickly.

NOTE: Change the engine oil when the oil is still warm.



OIL DRAIN PLUG  
TORQUE TO 10 ft-lb (13.6 N-m)



OIL FILL CAP

1. Put the outboard motor in an upright position (not tilted).
2. Prepare a suitable container that holds a larger amount than the engine oil capacity. Loosen and remove the drain plug while holding the container under the drain hole. The oil drain plug is located on the tiller side of the engine. Use a 12 mm socket wrench. Then remove the oil fill cap. Let the oil drain completely. Wipe up any spilled oil immediately.
3. Put a new gasket on the oil drain plug. Apply a light coat of oil to the gasket and install the drain screw.

NOTE: If a torque wrench is not available when you are installing the drain screw, finger tighten the screw just until the gasket comes in contact with the surface of the drain hole. Then tighten 1/4 to 1/2 turn more. Tighten the drain screw to the correct torque with a torque wrench as soon as possible.

4. Add the correct amount of oil through the filler hole. Install the filler cap.

# MAINTENANCE

5. Make sure that there are no oil leaks. Continued operation with an oil leak could cause severe engine damage.
6. Turn off the engine and wait 3 minutes. Recheck the oil level using the oil dipstick to be sure the level falls between the upper and lower marks when the dipstick is inserted in all the way. Add oil if the level is below the lower mark, or drain to the specified level if it is above the upper mark (see pg. 8).
7. Dispose of used oil according to local regulations.

NOTE: Change the oil more often when operating the engine under adverse conditions such as extended trolling.

Recommended engine oil: 10W - 30  
4-stroke outboard motor oil  
Engine oil quantity:  
0.8L (0.85 US qt)



OIL DIPSTICK HANDLE

## CHECKING WIRING AND CONNECTORS

- Check that each grounding wire is properly secured.
- Check that each connector is engaged and secured.

## EXHAUST LEAKAGE

Start the engine and check that no exhaust leaks from the joints between the exhaust cover, cylinder head, and cylinder.

## WATER LEAKAGE

Start the engine and check that no water leaks from the joints between the exhaust cover, cylinder head, cylinder, thermostat housing, and thermostat hose.

## CHECKING PROPELLER

**⚠ WARNING:** You could be seriously injured if the engine accidentally starts when you are near the propeller. Before inspecting, removing, or installing the propeller, remove the spark plug cap from the spark plug. Also, place the shift control in neutral, and remove the lanyard from the engine stop switch.

- Check each of the propeller blades for wear, erosion from cavitation, or other damage.
- Check the propeller shaft for damage.
- Check the splines for wear or damage.
- Check for fish line tangled around the propeller shaft.
- Check the propeller shaft oil seal for damage.

## REMOVING THE PROPELLER

1. Straighten the cotter pin and pull it out using a pair of pliers.
2. Remove the propeller nut and washer.
3. Remove the propeller and thrust washer.

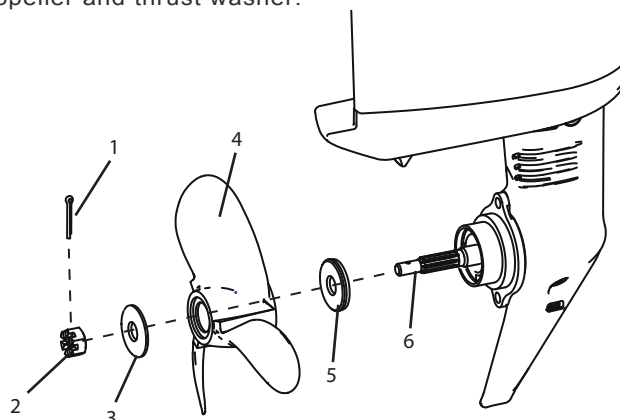

1. COTTER PIN
2. PROPELLER NUT
3. WASHER
4. PROPELLER
5. THRUST WASHER
6. PROPELLER SHAFT AND SPLINES

**⚠ WARNING:** Do not use your hand to hold the propeller when loosening or tightening the propeller nut. Put a wood block between the anti-cavitation plate and the propeller to prevent the propeller from turning.

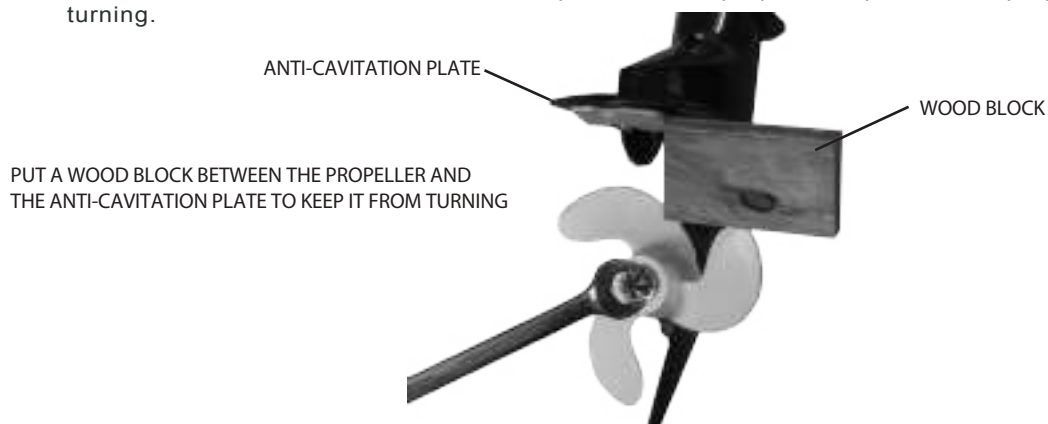

## INSTALLING THE PROPELLER

- Be sure to install the thrust washer before installing the propeller, otherwise the lower case and propeller boss could be damaged.
- Be sure to use a new cotter pin and bend the ends over securely. Otherwise the propeller could come off during operation and be lost.

1. Apply corrosion resistant grease to the propeller shaft.
2. Install the thrust washer, and propeller on the propeller shaft.
3. Install the washer. Tighten the propeller nut until there is no forward-and-backward movement.
4. Align the propeller nut with the propeller shaft hole. Insert a new cotter pin in the hole and bend the cotter pin ends.

**NOTE:** If the propeller nut does not align with the propeller shaft hole after tightening it, loosen the nut until it aligns with the hole.

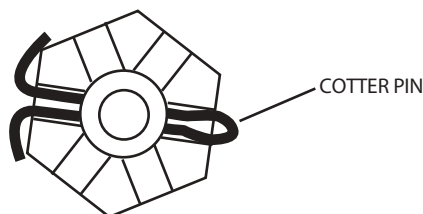

## PROPELLER SELECTION

Your LEHR outboard engine is supplied with a propeller that matches the needs of a boat most suited to an engine of its size. If you feel you are not getting optimal performance from the engine on your boat, a different pitch propeller could help. The performance of your outboard motor will be affected if you choose a different propeller, as an incorrect choice could adversely affect performance and could also seriously damage the motor. Engine speed depends on the propeller size and boat load. If engine speed is too high or too low for good engine performance, this will have an adverse effect on the engine. For a greater operating load, a smaller-pitch propeller is more suitable as it enables the correct engine speed to be maintained. Conversely, a larger-pitch propeller is more suitable for a smaller operation load.

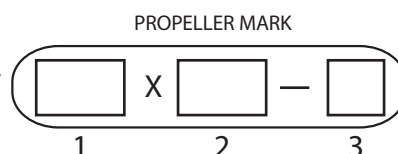

1. PROPELLER DIAMETER IN INCHES.
2. PROPELLER PITCH IN INCHES.
3. TYPE OF PROPELLER (PROPELLER MARK).

**NOTE:** Select a propeller which will allow the engine to reach the middle or upper half of the operation range at full throttle with the maximum boat load. In operation conditions such as light boat loads, do not allow the engine RPM to rise above the maximum recommended range, reduce the throttle setting to maintain the engine in the proper operation range.

# MAINTENANCE

## CHANGING GEAR OIL

- Be sure the outboard motor is securely fastened to the transom or a stable stand. You could be severely injured if the outboard motor falls on you.
- Never get under the lower unit while it is tilted, even when the tilt support lever or knob is locked. Severe injury could occur if the outboard motor accidentally falls.

1. Tilt the outboard motor so that the gear oil drain screw is at the lowest point possible.
2. Place a suitable container under the gear case.
3. Remove the gear oil drain screw.

Recommended gear oil:  
Hypoid gear oil SAE#90  
Gear oil quantity:  
0.26 US qt. (0.250 L)

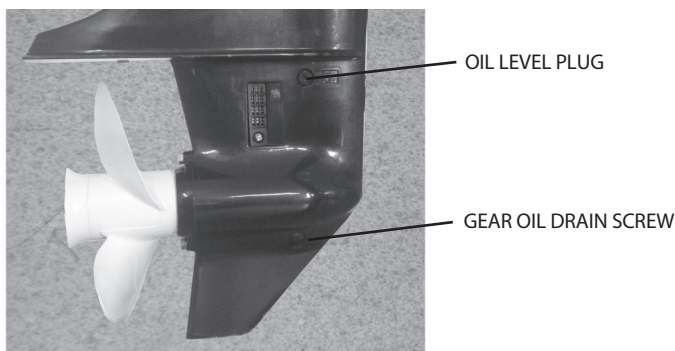

NOTE: If a magnetic gear oil drain screw is equipped, remove all metal particles from the screw before installing it.

- Always use new gaskets.
  - Do not reuse the removed gaskets.
4. Remove the oil level plug to allow the oil to drain completely. Inspect the used oil after it has been drained. If the oil is milky, water is getting into the gear case which can cause gear and bearing damage. Consult your LEHR dealer for repair of the lower unit seals.
  5. With the outboard motor in a vertical position and using a flexible or pressurized filling device, inject the gear oil into the gear oil drain screw hole.
  6. When the oil begins to flow out of the oil level plug hole, insert and tighten the oil level plug.
  7. Insert and tighten the gear oil drain screw.

## INSPECTING AND REPLACING ANODES

LEHR outboard motors are protected from corrosion by sacrificial anodes. Inspect the anodes periodically. Remove scales from the surfaces of the external anode. Do not paint the external anode, as this would render it ineffective.

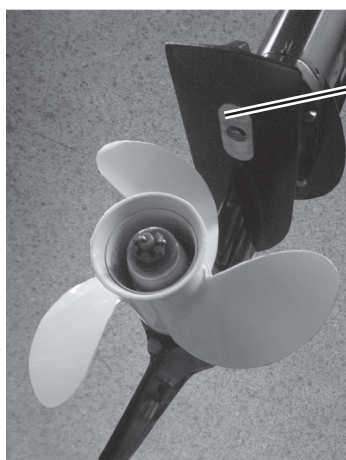

EXTERNAL ANODE

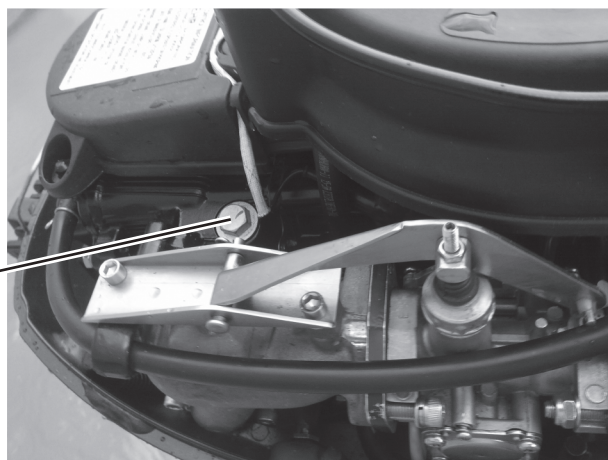

INTERNAL ANODE

## COATING THE BOAT BOTTOM

A clean hull improves boat performance. The boat bottom should be kept as clean of marine growth as possible. If necessary, the boat bottom can be coated with an anti-fouling paint approved for your area to inhibit marine growth. Do not use anti-fouling paint which includes copper or graphite. These paints can cause more rapid engine corrosion.

# TROUBLESHOOTING

A problem in the fuel, compression, or ignition systems can cause poor starting, loss of power, or other problems. This section describes basic checks and possible remedies. Whenever difficulties are encountered please call LEHR customer service for help. 1-866-941-LEHR (5347)

## ENGINE WILL NOT START OR OPERATE

Q: Is engine stop switch lanyard not attached?

A: Attach lanyard.

Q: Is throttle speed set incorrectly?

A: Set throttle speed to 1/8 - 1/4 or less, unless the weather is cold, then set to 1/4 - 1/2 throttle. See pg 10.

Q: Is shift lever in gear?

A: Shift to neutral.

Q: Is propane tank empty, and fully connected?

A: Shake the tank to feel for liquid, then be sure it is fully connected and the valve is opened correctly (slowly).

Q: Is the spark plug fouled or incorrect type?

A: Inspect spark plugs. Clean or replace with recommended type.

Q: Is spark plug cap fitted incorrectly?

A: Check and re-fit caps.

Q: Is ignition wiring damaged or poorly connected?

A: Check wires for wear or breaks. Tighten all loose connections. Replace worn or broken wires.

Q: Possible faulty ignition parts?

A: Have serviced by LEHR dealer.

Q: Possible faulty internal engine parts?

A: Have serviced by a LEHR dealer.

## ENGINE IDLES IRREGULARLY OR STALLS

Q: Is propane tank empty?

A: Check tank fluid level by shaking it.

Q: Is spark plug fouled or incorrect type or gap?

A: Inspect spark plug. Clean gap, adjust to correct gap or replace with recommended type.

Q: Is the Idle speed set correctly?

A: Adjust Idle screw or have serviced by LEHR dealer.

Q: Are fuel joints connected correctly?

A: Check for any leaks or smell of propane. Tighten any loose fittings. Replace any faulty fuel lines or connectors.

Q: Is thermostat faulty or clogged?

A: Have serviced by LEHR dealer.

Q: Is carburetor faulty?

A: Have serviced by LEHR dealer.

Q: Is engine oil level low?

A: Check oil level and add oil if needed.

## ENGINE POWER LOSS

Q: Is fuel supply running low?

A: Shake propane tank to determine if propane level is low. If so, replace tank or operate at reduced throttle settings until fuel supply is replenished.

Q: Is the engine running hot?

A: Check for debris around the water pump inlet in the lower unit, remove obstructions.

Q: Is fuel system obstructed?

A: Check for pinched or kinked fuel line or other obstructions in fuel line.

Q: Is propeller damaged?

A: Have propeller repaired or replaced.

# TROUBLESHOOTING

Q: Is propeller pitch or diameter incorrect?

A: Install correct propeller to operate outboard at its recommended speed.

Q: Is trim angle correct?

A: Adjust trim angle to achieve most efficient operation.

Q: Is motor mounted at incorrect height on transom?

A: Have motor adjusted to proper transom height.

Q: Is boat bottom fouled with marine growth?

A: Clean bottom of boat.

Q: Are weeds or other foreign matter tangled on gear housing?

A: Remove foreign matter and clean power unit.

Q: Is spark plug gap incorrect?

A: Inspect and adjust as specified.

Q: Is ignition wire damaged or poorly connected?

A: Check wires for wears and breaks.

Q: Have electrical wires failed?

A: Have serviced by a LEHR dealer.

Q: Is propeller damaged?

A: Have propeller repaired or replaced.

Q: Is propeller shaft damaged?

A: Have serviced by a LEHR dealer.

## IMPACT DAMAGE

**⚠WARNING:** The outboard motor can be seriously damaged by a collision while operating or traveling. Damage may make the outboard motor unsafe to operate.

If the outboard motor hits an object in the water, follow the procedure below.

1. Stop the engine immediately.
2. Inspect the control system and all components for damage. Also inspect boat for damage.
3. Whether damage is found or not, return to the nearest harbor slowly and carefully.
4. Have the outboard motor inspected before operating it again.

## STARTER WILL NOT OPERATE

If the start mechanism does not operate (the engine cannot be cranked with the starter), the engine can be started with an emergency starter rope.

**⚠WARNING:** Use this procedure only in an emergency and only to return to the port for repairs.

- Make sure the gear shift lever is in neutral. Otherwise the boat could unexpectedly start to move, which could result in an accident.
- Attach the engine stop switch lanyard to a secure place on your clothing, or your arm or leg while operating.
- Do not attach the lanyard to clothing that could tear loose. Do not route the cord where it could become entangled, preventing it from functioning.
- Avoid accidentally pulling the lanyard during normal operation. Loss of engine power means the loss of most steering control. Also without engine power, the boat could slow rapidly. This could cause people and objects in the boat to be thrown forward.
- Be sure no one is standing behind you when pulling the starter rope. It could whip behind you and hurt someone.
- An exposed, rotating flywheel is very dangerous. Keep loose clothing and other objects away when starting the engine. Do not touch the flywheel or other moving or parts when the engine is running.



## EMERGENCY ENGINE START

1. Remove the top engine cowling.
2. Remove the starter cover by unscrewing the bolts.
3. Make sure the engine is in neutral and that the switch is attached to the engine shut off switch.
4. Insert the knotted end of the emergency starter rope in the notch into the flywheel rotor and wind the rope several times clockwise.

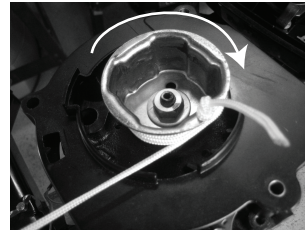
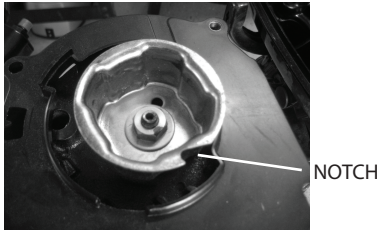

NOTE: If the rope is too long after winding it around the flywheel, shorten it at the handle.

5. Pull the rope slowly until resistance is felt.
6. Give a strong pull out to crank and start the engine. Repeat if necessary.

## PROCEDURE FOR SUBMERGED MOTOR

If the outboard motor has been submerged, immediately take it to a LEHR dealer. Some corrosion may begin almost immediately. If you cannot immediately take the outboard to a dealer, follow the procedures below in order to minimize engine damage.

1. Wash away mud, salt, seaweed, and debris with fresh water.
2. Remove the spark plug, then face the spark plug hole downward to allow any water, mud, or contaminants to drain.
3. Drain the engine oil completely.
4. Fill the sump with fresh engine oil.
5. Feed small drops of oil throughout carburetor and spark plug hole while cranking the manual starter or emergency starter rope.
6. Take the outboard motor to a LEHR dealer as soon as possible.

NOTE: Do not attempt to run the outboard motor until it has been inspected.

# SPECIFICATIONS

**MODELS LP 9.9** (S) SHORT SHAFT  
 (L) LONG SHAFT  
 (ES) ELECTRIC START, TILLER, SHORT SHAFT  
 (EL) ELECTRIC START, TILLER, LONG SHAFT  
 (ERS) ELECTRIC START, REMOTE STEERING, SHORT SHAFT  
 (ERL) ELECTRIC START, REMOTE STEERING, LONG SHAFT

ENGINE TYPE	WATER COOLED 4-CYCLE
DISPLACEMENT	12.94 cu. in (212 cc)
BORE X STROKE	2.29 in X 1.69 in (56 mm X 43 mm)
POWER	9.9 hp (7.2 kW)
MAX OPERATING R.P.M.	4500 - 5500 R.P.M.
IDLE SPEED	1000-1200 R.P.M.
IGNITION TYPE	ELECTRONIC CDI
IGNITION SWITCH	TETHER
VALVE CLEARANCE IN and EX (COLD)	INTAKE: 0.0059-0.0079 in (0.15-0.20mm) EXHAUST: 0.0079-0.0098 in (0.20-0.25mm)
SPARK PLUG TYPE	NGK BR6HS
SPARK PLUG GAP	0.020-0.024 in (0.5-0.6 mm)
SPARK PLUG TORQUE SPEC	18.4 ft.·lb. (25.0 N·m)
LUBRICATION OIL TYPE	4 STROKE 10W-30
CRANKCASE OIL CAPACITY	0.85 US qt. (0.8L)
GEAR OIL TYPE / CAPACITY	HYPOID GEAR OIL SAE#90 0.26 US qt. (0.250L)
FUEL	PROPANE
STARTER	PULL CHORD AUTO REWIND AND/OR PUSH BUTTON SWITCH
GEAR SHIFT	F – N – R
GEAR RATIO	2.08 (27/13)
TRANSOM HEIGHT	SHORT SHAFT 15 in (381 mm) LONG SHAFT 20 in (508 mm)
WEIGHT	87.7 lbs (39.8 kg) (S), 91.7 lbs (41.6 kg)(L) 97.7 lbs (44.3kg) (ES, ERS), 101.7 lbs (46.1 kg)(EL, ERL)
PROPELLER NUT TORQUE SPEC	12.5 ft·lb (17.0 N·m)
OIL DRAIN PLUG TORQUE SPEC	17.7 ft·lb (24.0 N·m)

\*ALL SPECIFICATIONS ARE BASED ON THE LATEST PRODUCT INFORMATION AT THE TIME OF PRINTING.  
 WE RESERVE THE RIGHT TO MAKE CHANGES AT ANY TIME WITHOUT NOTICE.

# MANUFACTURER'S LIMITED WARRANTY

The limited warranty set forth below is given by LEHR with respect to new merchandise purchased and used in the United States and Canada, its possessions and territories. LEHR warrants to the original purchaser that each new LEHR brand outboard is free from defects in material and workmanship and agrees to repair or replace under this warranty any defective product or attachment as follows from the original date of purchase.

3 YEARS -- Parts and Labor.

90 DAYS -- Parts and Labor, when used for income producing purposes.

30 DAYS -- Parts and Labor, if used for rental purposes.

This warranty is not transferable and does not cover damage or liability caused by improper handling, improper maintenance, or the use of accessories not specifically recommended by LEHR for this product. In addition, it does not cover any product that has been subject to misuse, neglect, negligence, or accident, or has been operated in any way contrary to the operating instructions specified in this operator's manual. Additionally, this warranty does not cover tune-ups, spark plugs, carburetor adjustments, starter pulley or parts that will wear and require replacement with reasonable use during the warranty period. This warranty does not cover pre delivery setup or normal adjustments explained in the instruction manual. Shipping of parts is not the responsibility of LEHR.

THIS WARRANTY GIVES YOU SPECIFIC LEGAL RIGHTS, AND YOU MAY HAVE OTHER RIGHTS WHICH VARY FROM STATE TO STATE. NO CLAIMS FOR CONSEQUENTIAL OR OTHER DAMAGES WILL BE ALLOWED, AND THERE ARE NO OTHER EXPRESS WARRANTIES EXCEPT THOSE EXPRESSLY STIPULATED HEREIN. SOME STATES DO NOT ALLOW LIMITATIONS ON HOW LONG AN IMPLIED WARRANTY LAST OR THE EXCLUSION OR LIMITATIONS OF INCIDENTAL OR CONSEQUENTIAL DAMAGES, SO THE ABOVE LIMITATIONS OR EXCLUSION MAY NOT APPLY TO YOU.

LEHR does not extend any warranty for products sold or exported outside of the United States or Canada, its possessions and territories, except those sold through LEHR's authorized channels of export distribution. The policy of LEHR is to continuously improve its products. Therefore, LEHR reserves the right to change, modify, or discontinue models, designs, specifications of all products at any time without notice or obligation to any purchaser.

**HOW TO OBTAIN SERVICE:** Warranty service is available, with proof of purchase through your local authorized service dealer. To locate the dealer in your area, visit our website at [www.golehr.com](http://www.golehr.com) or call 1-866-941-LEHR or write to 8922 Ellis Ave. LA, CA 90034.

## CALIFORNIA EMISSIONS/EPA CONTROL WARRANTY STATEMENT YOUR WARRANTY RIGHTS AND OBLIGATIONS

The California Air Resources Board, the Environmental Protection Agency and LEHR, Inc. are pleased to explain the emissions control system's warranty on your 2013 and later marine engine. In California and the 49 states, new equipment that use marine engines must be designed, built, and equipped to meet the State's stringent anti-smog standards. LEHR, Inc. must warrant the emissions control system on your small off-road engine for the period listed below provided there has been no abuse, neglect or improper maintenance of your engine.

Your emissions control system may include parts such as: carburetors or fuel injection system, ignition system, catalytic converters, fuel tanks, valves, filters, clamps, connectors, and other associated components. Also, included may be hoses, belts, connectors, sensors, and other emission-related assemblies.

Where a warrantable condition exists, LEHR will repair your marine engine at no cost to you including diagnosis, parts and labor.

### MANUFACTURER'S WARRANTY COVERAGE:

This emissions control system is warranted for ten years. If any emissions-related part on your equipment is defective, the part will be repaired or replaced by LEHR.

### OWNER'S WARRANTY RESPONSIBILITIES:

- As the marine engine owner, you are responsible for performance of the required maintenance listed in your owner's manual. LEHR recommends that you retain all receipts covering maintenance on your marine engine, but LEHR cannot deny warranty solely for the lack of receipts or your failure to ensure the performance of all scheduled maintenance.
- As the marine engine owner, you should however be aware that LEHR may deny you warranty coverage if your marine engine or a part has failed due to abuse, neglect, or improper maintenance or unapproved modifications.
- You are responsible for presenting your marine engine to a LEHR service center as soon as the problem exists. The warranty repairs should be completed in a reasonable amount of time, not to exceed 30 days. If you have a question regarding your warranty coverage, you should contact LEHR at 1-866-941-LEHR.

# MANUFACTURER'S LIMITED WARRANTY

## DEFECTS WARRANTY REQUIREMENTS:

(a) The warranty period begins on the date the engine or equipment is delivered to an ultimate purchaser.

(b) General Emissions Warranty Coverage. The manufacturer of each marine engine or equipment must warrant to the ultimate purchaser and each subsequent owner that the engine or equipment is:

- (1) Designed, built, and equipped so as to conform with all applicable regulations adopted by the Air Resources Board; and
- (2) Free from defects in materials and workmanship that causes the failure of a warranted part for a period of ten years.

(c) The warranty on emissions-related parts will be interpreted as follows:

- (1) Any warranted part that is not scheduled for replacement as required maintenance in the written instructions required by Subsection (d) must be warranted for the warranty period defined in Subsection (b)(2). If any such part fails during the period of warranty coverage, it must be repaired or replaced by the manufacturer according to Subsection (4) below. Any such part repaired or replaced under the warranty must be warranted for the remaining warranty period.
- (2) Any warranted part that is scheduled only for regular inspection in the written instructions required by Subsection (d) must be warranted for the warranty period defined in Subsection (b)(2). A statement in such written instructions to the effect of "repair or replace as necessary" will not reduce the period of warranty coverage. Any such part repaired or replaced under warranty must be warranted for the remaining warranty period.
- (3) Any warranted part that is scheduled for replacement as required maintenance in the written instructions required by Subsection (d) must be warranted for the period of time prior to the first scheduled replacement point for that part. If the part fails prior to the first scheduled replacement, the part must be repaired or replaced by the engine manufacturer according to Subsection (4) below. Any such part repaired or replaced under warranty must be warranted for the remainder of the period prior to the first scheduled replacement point for the part.
- (4) Repair or replacement of any warranted part under the warranty must be performed at no charge to the owner at a warranty station.
- (5) Notwithstanding the provisions of Subsection (4) above, warranty services or repairs must be provided at all manufacturer distribution centers that are franchised to service the subject engines.
- (6) The owner must not be charged for diagnostic labor that leads to the determination that a warranted part is in fact defective, provided that such diagnostic work is performed at a warranty station.
- (7) The manufacturer is liable for damages to other engine components proximately caused by a failure under warranty of any warranted part.
- (8) Throughout the emissions warranty period defined in Subsection (b)(2), the manufacturer must maintain a supply of warranted parts sufficient to meet the expected demand for such parts.
- (9) Any replacement part may be used in the performance of any warranty maintenance or repairs and must be provided without charge to the owner. Such use will not reduce the warranty obligations of the manufacturer.
- (10) Add-on or modified parts that are not exempted by the Air Resources Board may not be used. The use of any non-exempted add-on or modified parts will be grounds for disallowing a warranty claim. The manufacturer will not be liable to warrant failures of warranted parts caused by the use of a non-exempted add-on or modified part.
- (11) The manufacturer issuing the warranty shall provide any documents that describe that manufacturer's warranty procedures or policies within five working days of request by the Air Resources Board.

(d) Emission Warranty Parts List. The following components are included in the emission related warranty of the engine: Carburetor, Fuel Lines & Fittings, Ignition Coil, Spark Plug, Valves, and Cam. LEHR will furnish with each new engine written instructions for the maintenance and use of the engine by the owner.





### **One Star – Low Emission**

The one-star label identifies Personal Watercraft, Outboard, Sterndrive and Inboard engines that meet the Air Resources Board's Personal Watercraft and Outboard marine engine 2001 exhaust emission standards. Engines meeting these standards have 75% lower emissions than conventional carbureted two-stroke engines. These engines are equivalent to the U.S. EPA's 2006 standards for marine engines.



### **Two Stars – Very Low Emission**

The two-star label identifies Personal Watercraft, Outboard, Sterndrive and Inboard engines that meet the Air Resources Board's Personal Watercraft and Outboard marine engine 2004 exhaust emission standards. Engines meeting these standards have 20% lower emissions than One Star – Low-Emission engines.



### **Three Stars – Ultra Low Emission**

The three-star label identifies engines that meet the Air Resources Board's Personal Watercraft and Outboard marine engine 2008 exhaust emission standards or the Sterndrive and Inboard marine engine 2003 exhaust emission standards. Engines meeting these standards have 65% lower emissions than One Star – Low Emission engines.



### **Four Stars – Super Ultra Low Emission**

The four-star label identifies engines that meet the Air Resources Board's Sterndrive and Inboard marine engine 2009 exhaust emission standards. Personal Watercraft and Outboard marine engines may also comply with these standards. Engines meeting these standards have 90% lower emissions than One Star – Low Emission engines.



LEHR INC.  
8922 ELLIS AVE  
LOS ANGELES, CA 90034  
1-866-941-LEHR

Cleaner Watercraft – Get the Facts  
1-800-END-SMOG  
[www.arb.ca.gov](http://www.arb.ca.gov)