

Owner's Manual

Outboard Motor Series

● **F20**

● **F25**

Important manual information

To the owner

Thank you for choosing outboard motor. This Owner's Manual contains information needed for proper operation, maintenance and care. A thorough understanding of these simple instructions will help you obtain maximum enjoyment from your new If you have any question about the operation or maintenance of your outboard motor, please consult dealer.

In this Owner's Manual particularly important information is distinguished in the following ways.

 The Safety Alert Symbol means ATTENTION! BECOME ALERT! YOUR SAFETY IS INVOLVED!

WARNING
Failure to follow WARNING instructions could result in severe injury or death to the machine operator, a bystander, or a person inspecting or repairing the outboard motor.

CAUTION:
A CAUTION indicates special precautions that must be taken to avoid damage to the outboard motor.

NOTE:
A NOTE provides key information to make procedures easier or clearer.

We continually seek advancements in product design and quality. Therefore, while this manual contains the most current product information available at the time of printing, there may be minor discrepancies between your machine and this manual. If there is any question concerning this manu-

al, please consult your dealer.

To ensure long product life, we recommend that you use the product and perform the specified periodic inspections and maintenance by correctly following the instructions in the owner's manual. Note that if you do not follow these instructions, not only may the product break down, but the warranty will also be voided.

Some countries have laws or regulations restricting users from taking the product out of the country where it was purchased, and it may be impossible to register the product in the destination country. Additionally, the warranty may not apply in certain regions. When planning to take the product to another country, consult the dealer where the product was purchased for further information.

If the product was purchased used, please consult your closest dealer for customer registration, and to be eligible for the specified services.

NOTE:
The F25 and the standard accessories are used as a base for the explanations and illustrations in this manual. Therefore some items may not apply to every model.

Read this owner's manual carefully before operating your outboard motor.

Table of contents

General information	1	Preoperation checks.....	15
Identification numbers record	1	Fuel	15
Outboard motor serial number	1	Controls	15
Safety information	1	Engine	16
Important labels	2	Checking the engine oil level	16
Warning labels	2	Filling fuel	16
Caution labels	3	Operating engine	17
Fueling instructions	3	Feeding fuel (portable tank)	17
Gasoline	3	Starting engine	18
Engine oil	3	Warming up engine	19
Propeller selection	4	Manual start and electric start	19
Start-in-gear protection	5	models	19
Basic components	6	Shifting	19
Main components	6	Forward (tiller handle and remote	20
Fuel tank	6	control models)	20
Fuel joint	7	Reverse (manual tilt and hydro tilt	20
Fuel gauge	7	models)	20
Fuel tank cap	7	Stopping engine	21
Air vent screw	7	Procedure	21
Tiller handle	7	Trimming outboard motor	21
Gear shift lever	7	Adjusting trim angle for manual tilt	22
Throttle grip	7	models	22
Throttle indicator	8	Adjusting boat trim	22
Throttle friction adjuster	8	Tilting up and down	23
Engine stop lanyard switch	8	Procedure for tilting up	24
Engine stop button	9	(manual tilt models)	24
Manual starter handle	9	Procedure for tilting down	25
Steering friction adjuster	9	(manual tilt models)	25
Trim tab	9	Cruising in shallow water	25
Trim rod (tilt pin)	10	Cruising in shallow water	25
Tilt lock mechanism	10	(manual tilt models)	25
Tilt support bar	10	Cruising in other conditions	26
Top cowling lock lever(s)	11	Maintenance	27
(tum type)	11	Specifications	27
Warning indicator	11	Transporting and storing	28
Warning system	11	outboard motor	28
Overheat warning	11	Clamp screw mounting models	28
Low oil pressure warning	12	Storing outboard motor	28
Operation	13	Procedure	29
Installation	13	Lubrication	30
Mounting the outboard motor	13	(except oil injection models)	30
Clamping the outboard motor	14	Cleaning the outboard motor	30
Breaking in engine	15	Checking painted surface of	30
Procedure for 4-stroke models	15	motor	30
		Periodic maintenance	30

Table of contents

Replacement parts	30
Maintenance chart	31
Maintenance chart (additional)	32
Greasing	33
Cleaning and adjusting spark	33
plug	33
Checking fuel system	34
Inspecting fuel filter	35
Cleaning fuel filter	35
Inspecting idling speed	36
Changing engine oil	36
Checking wiring and connectors	38
Exhaust leakage	38
Water leakage	39
Engine oil leakage	39
Checking propeller	39
Removing the propeller	40
Installing the Propeller	40
Changing gear oil	40
Cleaning fuel tank	41
Inspecting and replacing	42
anode(s)	42
Checking top cowling	42
Coating the boat bottom	42
Trouble Recovery	44
Troubleshooting	44
Temporary action in	47
emergency	47
Impact damage	47
Starter will not operate	47
Emergency starting engine	48
Treatment of submerged motor	49
Procedure	49

General information

Identification numbers record

Outboard motor serial number

The outboard motor serial number is stamped on the label attached to the port side of the clamp bracket or the upper part of the swivel bracket.

Record your outboard motor serial number in the spaces provided to assist you in ordering spare parts from your dealer or for reference in case your outboard motor is stolen.



1. Outboard motor serial number location



Safety information

- Before mounting or operating the outboard motor, read this entire manual. Reading it should give you an understanding of the

motor and its operation.

- Before operating the boat, read any owner's or operator's manuals supplied with it and all labels. Be sure you understand each item before operating.
- Do not overpower the boat with this outboard motor. Overpowering the boat could result in loss of control. The rated power of the outboard should be equal to or less than the rated horsepower capacity of the boat. If the rated horsepower capacity of the boat is unknown, consult the dealer or boat manufacturer.
- Do not modify the outboard. Modifications could make the motor unfit or unsafe to use.
- Incorrect propeller selection and incorrect use may not only cause engine damage, but also adversely affect fuel consumption. Consult your dealer for correct use.
- Never operate after drinking alcohol or taking drugs. About 50% of all boating fatalities involve intoxication.
- Have an approved personal flotation device (PFD) on board for every occupant. It is a good idea to wear a PFD whenever boating. At a minimum, children and non-swimmers should always wear PFDs, and everyone should wear PFDs when there are potentially hazardous boating conditions.
- Gasoline is highly flammable, and its vapors are flammable and explosive. Handle and store gasoline carefully. Make sure there are no gas fumes or leaking fuel before starting the engine.
- This product emits exhaust gases which contain carbon monoxide, a colorless, odorless gas which may cause brain damage or death when inhaled. Symptoms include nausea, dizziness, and drowsiness.

Keep cockpit and cabin areas well ventilated. Avoid blocking exhaust outlets.

- Check throttle, shift, and steering for proper operation before starting the engine.
- Attach the engine stop switch lanyard to a secure place on your clothing, or your arm or leg while operating. If you accidentally leave the helm, the lanyard will pull from the switch, stopping the engine.
- Know the marine laws and regulations where you will be boating - and obey them.
- Stay informed about the weather. Check weather forecasts before boating. Avoid boating in hazardous weather.
- Tell someone where you are going; leave a Float Plan with a responsible person. Be sure to cancel the Float Plan when you return.
- Use common sense and good judgment when boating. Know your abilities, and be sure you understand how your boat handles under the different boating conditions you may encounter. Operate within your limits, and the limits of your boat. Always operate at safe speeds, and keep a careful watch for obstacles and other traffic.
- Always watch carefully for swimmers during the engine operation.
- Stay away from swimming areas.
- When a swimmer is in the water near you shift into neutral and shut off the engine.
- Do not illegally discard empty containers used to replace or replenish oil. For the correct processing of empty containers, consult the dealer where you purchased the oil.
- When replacing oils used to lubricate the product (engine or gear oil), be sure to wipe away any spill oil. Never pour oil without using a funnel or similar device. If necessary, verify the necessary replacement

General information

procedure with the dealer.

- Never illegally discard (dump) the product. recommends consulting the dealer on discarding the product.

Important labels

Warning labels



Label

WARNING

- Be sure shift control is in neutral before starting engine. (except 2HP)
- Do not touch or remove electrical parts when starting or during operation.
- Keep hands, hair, and clothes away from flywheel and other rotating parts while engine is running.

Label

WARNING

- This engine is equipped with a neutral starting device.
- The engine will not start unless the shift control is in neutral position.

General information

Caution labels



Label

CAUTION:

Transport and store the engine only as shown. Otherwise, engine damage could result from Leaking oil.

Fueling instructions

WARNING

GASOLINE AND ITS VAPORS ARE HIGHLY FLAMMABLE AND EXPLOSIVE!

- Do not smoke when refueling, and keep away from sparks, flames, or other sources of ignition.
- Stop engine before refueling.
- Refuel in a well-ventilated area. Refuel portable fuel tanks off the boat.
- Take care not to spill gasoline. If gasoline spills, wipe it up immediately with dry rags.
- Do not overfill the fuel tank.
- Tighten the filler cap securely after refueling.
- If you should swallow some gasoline, inhale a lot of gasoline vapor, or get gasoline in your eyes, get immediate

medical attention.

- If any gasoline spills onto your skin, immediately wash with soap and water. Change clothing if gasoline spills on it.
- Touch the fuel nozzle to the filler opening or funnel to help prevent electrostatic sparks.

CAUTION:

Use only new clean gasoline which has been stored in clean containers and is not contaminated with water or foreign matter.

Gasoline

Recommended gasoline:
Regular unleaded gasoline

If knocking or pinging occurs, use a different brand of gasoline or premium unleaded fuel. If unleaded gasoline is not available, then premium gasoline can be used. If leaded gasoline is usually used, engine valves and related parts should be inspected after every 300 hours of operation.

Engine oil

Recommended engine oil:
4-stroke motor oil with a combination of the following SAE and API oil classifications

Engine oil type SAE:
10W-30 or 10W-40

Engine oil grade API:
SE, SF, SG, SH, SJ, SL

Engine oil quantity (excluding oil filter):
1.7 L (1.80 US qt) (1.50 Imp. qt)

NOTE:

If the recommended engine oil grades are

General information

not available, select an alternative from the following chart according to the average temperatures in your area.

SAE		API					
-4	14	32	50	66	104	122.7	
-20	-10	0	10	20	30	40	50
10W-30		SE		SF		SG	
10W-40		SH		SJ		SL	
5W-30		SH		SJ		SL	
15W-40		SH		SJ		SL	
20W-40		SH		SJ		SL	

CAUTION:

All 4-stroke engines are shipped from the factory without engine oil.



Propeller selection

The performance of your outboard motor will be critically affected by your choice of propeller, as an incorrect choice could adversely affect performance and could also seriously damage the motor. Engine speed depends on the propeller size and boat load. If engine

speed is too high or too low for good engine performance, this will have an adverse effect on the engine.

These outboard motors are fitted with propellers chosen to perform well over a range of applications, but there may be uses where a propeller with a different pitch would be more appropriate. For a greater operating load, a smaller-pitch propeller is more suitable as it enables the correct engine speed to be maintained. Conversely, a larger-pitch propeller is more suitable for a smaller operating load.

The dealers stock a range of propellers, and can advise you and install a propeller on your outboard that is best suited to your application.

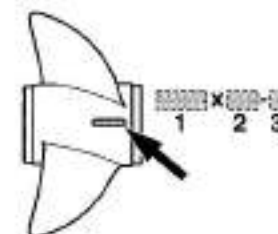

1. Propeller diameter in inches
2. Propeller pitch in inches
3. Type of propeller (propeller mark)

NOTE:

Select a propeller which will allow the engine to reach the middle or upper half of the operating range at full throttle with the maximum boat load. If operating conditions such as light boat loads then allow the engine r/min to rise above the maximum recommended range, reduce the throttle setting to maintain the engine in the proper operating range.

General information

For instructions on propeller removal and installation, see page 39.

Start-in-gear protection

The outboard motors or approved remote control units are equipped with start-in-gear protection device(s). This feature permits the engine to be started only when it is in neutral. Always select neutral before starting the engine.

Basic components

Main components

NOTE:

* May not be exactly as shown; also may not be included as standard equipment on all models.

- F20
- F25

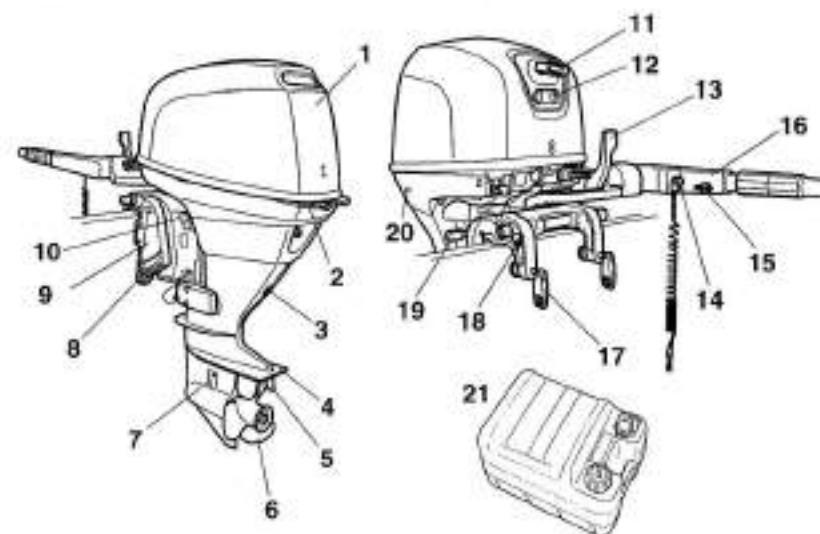

1. Top cowling
2. Top cowling lock lever
3. Drain screw
4. Anti-cavitation plate
5. Trim tab
6. Propeller
7. Cooling water inlet
8. Trim rod
9. Trim rod
10. Steering friction adjuster
11. Manual starter handle
12. Warning indicator
13. Gear shift lever
14. Engine stop button/Engine stop lanyard switch

15. Throttle friction adjuster
16. Tiller handle
17. Clamp screw
18. Rope attachment
19. Tilt lock lever
20. Cooling water pilot hole
21. Fuel tank

Fuel tank

If your model was equipped with a portable

Basic components

fuel tank, its function is as follows.

⚠ WARNING

The fuel tank supplied with this engine is its dedicated fuel reservoir and must not be used as a fuel storage container. Commercial users should conform to relevant licensing or approval authority regulations.



1. Fuel joint
2. Fuel gauge
3. Fuel tank cap
4. Air vent screw

Fuel joint

This joint is used to connect the fuel line.

Fuel gauge

This gauge is located on either the fuel tank cap or on the fuel joint base. It shows the approximate amount of fuel remaining in the tank.

Fuel tank cap

This cap seals the fuel tank. When removed, the tank can be filled with fuel. To remove the cap, turn it counterclockwise.

Air vent screw

This screw is on the fuel tank cap. To loosen the screw, turn it counterclockwise.

Tiller handle

To change direction, move the tiller handle to the left or right as necessary.

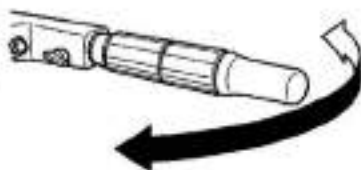

Gear shift lever

Pulling the gear shift lever towards you puts the engine in forward gear so that the boat moves ahead. Pushing the lever away from you puts the engine in reverse gear so that the boat moves astern.

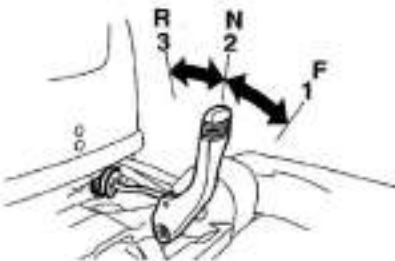

1. Forward "F"
2. Neutral "N"
3. Reverse "R"

Throttle grip

The throttle grip is on the tiller handle. Turn the grip counterclockwise to increase speed and clockwise to decrease speed.

Basic components

there is too much resistance, it could be difficult to move throttle lever or grip, which could result in an accident.

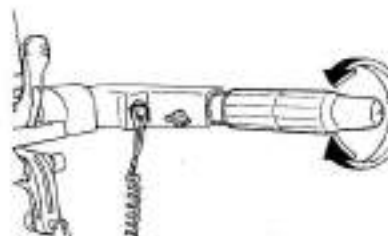

Throttle indicator

The fuel consumption curve on the throttle indicator shows the relative amount of fuel consumed for each throttle position. Choose the setting that offers the best performance and fuel economy for the desired operation.

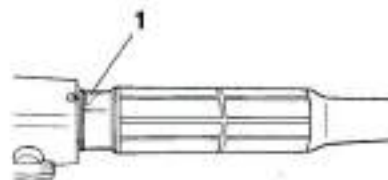

1. Throttle indicator

Throttle friction adjuster

A friction device provides adjustable resistance to movement of the throttle grip or the remote control lever, and can be set according to operator preference.

To increase resistance, turn the adjuster clockwise. To decrease resistance, turn the adjuster counterclockwise.

⚠ WARNING

Do not overtighten the friction adjuster. If



When constant speed is desired, tighten the adjuster to maintain the desired throttle setting.

Engine stop lanyard switch

The lock plate must be attached to the engine stop switch for the engine to run. The lanyard should be attached to a secure place on the operator's clothing, or arm or leg. Should the operator fall overboard or leave the helm, the lanyard will pull out the lock plate, stopping ignition to the engine. This will prevent the boat from running away under power.

⚠ WARNING

- Attach the engine stop switch lanyard to a secure place on your clothing, or your arm or leg while operating.
- Do not attach the lanyard to clothing that could tear loose. Do not route the lanyard where it could become entangled, preventing it from functioning.
- Avoid accidentally pulling the lanyard during normal operation. Loss of engine power means the loss of most steering control. Also, without engine power, the boat could slow rapidly. This

Basic components

could cause people and objects in the boat to be thrown forward.

NOTE:

The engine cannot be started with the lock plate removed.

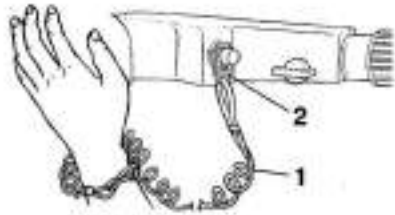

1. Lanyard
2. Lock plate

Engine stop button

To open the ignition circuit and stop the engine, push this button.

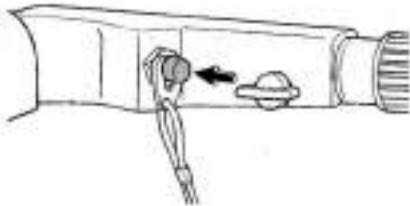

Manual starter handle

To start the engine, first gently pull the handle out until resistance is felt. From that position, then pull the handle straight out quickly to crank the engine.

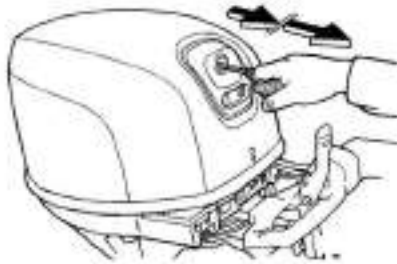

Steering friction adjuster

A friction device provides adjustable resistance to the steering mechanism, and can be set according to operator preference. An adjusting screw or bolt is located on the swivel bracket.

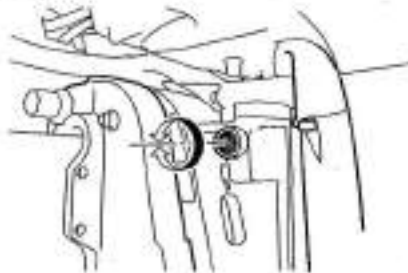

To increase resistance, turn the adjuster clockwise.

To decrease resistance, turn the adjuster counterclockwise.

WARNING

Do not overtighten the friction adjuster. If there is too much resistance, it could be difficult to steer, which could result in an accident.

Trim tab

The trim tab should be adjusted so that the steering control can be turned to either the

right or left by applying the same amount of force.

WARNING

An improperly adjusted trim tab could cause difficult steering. Always test run after the trim tab has been installed or replaced to be sure steering is correct. Be sure you have tightened the bolt after adjusting the trim tab.

If the boat tends to veer the left (port side), turn the trim tab rear end to the port side "A" in the figure.

If the boat tends to veer the right (starboard side), turn the trim tab end to the starboard side "B" in the figure.

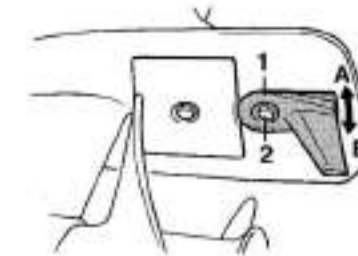

1. Trim tab
2. Bolt

Trim rod (tilt pin)

The position of the trim rod determines the minimum trim angle of the outboard motor in relation to the transom.

Basic components



Tilt lock mechanism

The tilt lock mechanism is used to prevent the outboard motor from lifting out of the water when in reverse gear.

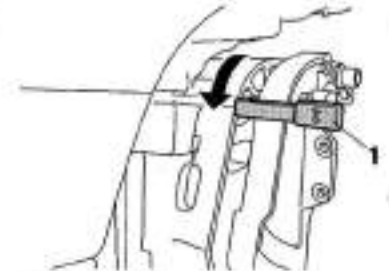

1. Tilt lock lever

To lock it, set the tilt lock lever in the lock position. To release, push the tilt lock lever in the release position.

Tilt support bar

The tilt support bar keeps the outboard motor in the tilted up position.

Basic components



Top cowling lock lever(s) (turn type)

To remove the engine top cowling, turn the lock lever(s) and lift off the cowling. When installing the cowling, check to be sure it fits properly in the rubber seal. Then lock the cowling again by returning the lever(s) to the lock position.



1. Top cowling lock lever(s)

Warning indicator

If the engine develops a condition which is cause for warning, the indicator lights up. For details on how to read the warning indicator, see page 11.

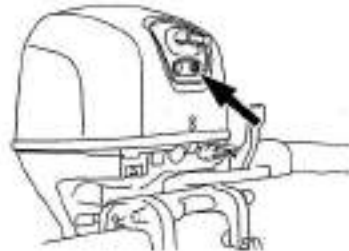

Warning system

CAUTION:

Do not continue to operate the engine if a warning device has activated. Consult your dealer if the problem cannot be located and corrected.

Overheat warning

This engine has an overheat warning device. If the engine temperature rises too high, the warning device will activate.

Activation of warning device

- The engine speed will automatically decrease to about 2000 r/min.
- If equipped with an overheat warning indicator, it will light.
- The buzzer will sound (if equipped on the tiller handle, remote control box, or main switch panel).

If the warning system has activated, stop the engine and check the cooling water inlet for clogging.

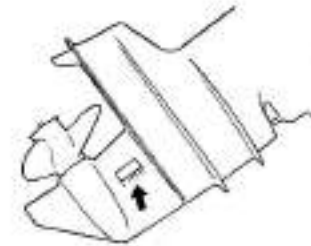

Low oil pressure warning

If the oil pressure drops too low, the warning device will activate.

Activation of warning device

- The engine speed will automatically decrease to about 2000 r/min.
- The low oil pressure warning indicator will light.



- The buzzer will sound (if equipped on the tiller handle, remote control box, or main switch panel).

If the warning system has activated, stop the engine as soon as it is safe to do so. Check the oil level and add oil as needed. If the oil level is correct and the warning device does not switch off, consult your dealer.

CAUTION:

Do not continue to run the engine if the low oil pressure warning indicator is on.

Basic components

Serious engine damage could occur.

Installation

CAUTION:

Incorrect engine height or obstructions to smooth water flow (such as the design or condition of the boat, or accessories such as transom ladders or depth finder transducers) can create airborne water spray while the boat is cruising. Severe engine damage may result if the motor is operated continuously in the presence of airborne water spray.

NOTE:

During water testing check the buoyancy of the boat, at rest, with its maximum load. Check that the static water level on the exhaust housing is low enough to prevent water entry into the powerhead, when water rises due to waves when the outboard is not running.

Mounting the outboard motor

WARNING

- Overpowering a boat could cause severe instability. Do not install an outboard motor with more horsepower than the maximum rating on the capacity plate of the boat. If the boat does not have a capacity plate, consult the boat manufacturer.
- The information presented in this section is intended as reference only. It is not possible to provide complete instructions for every possible boat and motor combination. Proper mounting depends in part on experience and the

specific boat and motor combination.

WARNING

Improper mounting of the outboard motor could result in hazardous conditions such as poor handling, loss of control, or fire hazards. Observe the following:

- For permanently mounted models, your dealer or other person experienced in proper rigging should mount the motor. If you are mounting the motor yourself, you should be trained by an experienced person.
- For portable models, your dealer or other person experienced in proper outboard motor mounting should show you how to mount your motor.

Mount the outboard motor on the center line (keel line) of the boat, and ensure that the boat itself is well balanced. Otherwise the boat will be hard to steer. For boats without a keel or which are asymmetrical, consult your dealer.

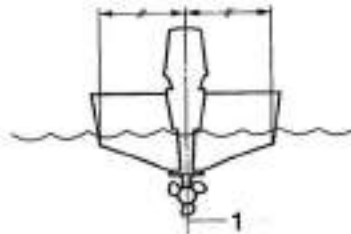

1. Center line (keel line)

Mounting height

To run your boat at optimum efficiency, the water resistance (drag) of the boat and outboard motor must be made as little as possible. The mounting height of the outboard

motor greatly affects the water resistance. If the mounting height is too high, cavitation tends to occur, thus reducing the propulsion; and if the propeller tips out the air, the engine speed will rise abnormally and cause the engine to overheat. If the mounting height is too low, the water resistance will increase and thereby reduce engine efficiency. Mount the outboard motor so that the anti-cavitation plate is between the bottom of the boat and a level 25 mm (1 in.) below it.

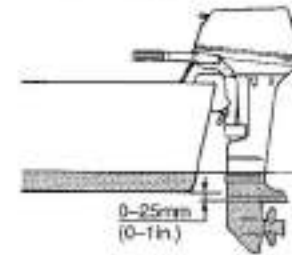

NOTE:

- The optimum mounting height of the outboard motor is affected by the boat and motor combination and the desired use. Test runs at different heights can help determine the optimum mounting height. Consult your dealer or boat manufacturer for further information on determining the proper mounting height.
- For instructions on setting the trim angle of the outboard motor, see page 21.

Clamping the outboard motor

1. Place the outboard motor on the transom so that it is positioned as close to the center as possible. Tighten the transom clamp screws evenly and securely. Occasionally check the clamp screws for tightness during operation of the outboard motor because they could be-

come loose due to engine vibration.

WARNING

Loose clamp screws could allow the outboard motor to fall off or move on the transom. This could cause loss of control and serious injury. Make sure the transom screws are tightened securely. Occasionally check the screws for tightness during operation.

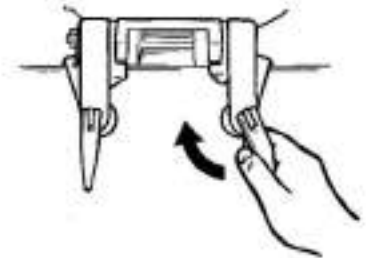

2. If the engine restraint cable attachment is equipped on your engine, an engine restraint cable or chain should be used. Attach one end to the engine restraint cable attachment and the other to a secure mounting point on the boat. Otherwise the engine could be completely lost if it accidentally falls off the transom.

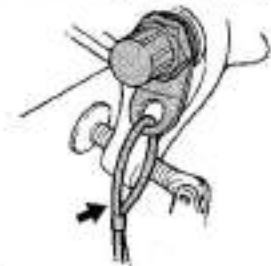

3. Secure the clamp bracket to the transom using the bolts provided with the out-

Operation

board (if packed). For details, consult your dealer.

WARNING

Avoid using bolts, nuts or washers other than those contained in the engine packaging. If used, they must be of at least the same quality of material and strength and must be tightened securely. After tightening, test run the engine and check their tightness.

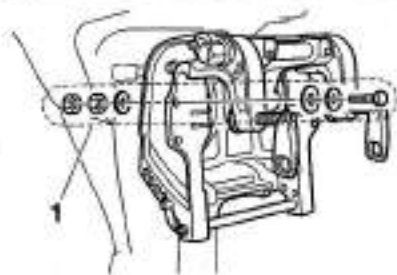

1. Bolts

Breaking in engine

Your new engine requires a period of break-in to allow mating surfaces of moving parts to wear in evenly. Correct break-in will help ensure proper performance and longer engine life.

CAUTION:

Failure to follow the break-in procedure could result in reduced engine life or even severe engine damage.

Procedure for 4-stroke models

Run the engine under load (in gear with a propeller installed) as follows.

1. For the first hour of operation:

- Run the engine at 2000 r/min or at approximately half throttle.
2. For the second hour of operation: Run the engine at 3000 r/min or at approximately three-quarter throttle.
3. For the next eight hours of operation: Avoid continuous operation at full throttle for more than five minutes at a time.
4. After the first 10 hours: Operate the engine normally.

Preoperation checks

WARNING

If any item in the preoperation check is not working properly, have it inspected and repaired before operating the outboard motor. Otherwise an accident could occur.

CAUTION:

Do not start the engine out of water. Overheating and serious engine damage can occur.

Fuel

- Check to be sure you have plenty of fuel for your trip.
- Make sure there are no fuel leaks or gasoline fumes.
- Check fuel line connections to be sure they are tight (if equipped fuel tank or boat tank).
- Be sure the fuel tank is positioned on a secure, flat surface, and that the fuel line is not twisted or flattened, or likely to contact sharp objects (if equipped fuel tank or boat tank).

Controls

- Check throttle, shift, and steering for prop-

er operation before starting the engine.

- The controls should work smoothly, without binding or unusual free play.
- Look for loose or damaged connections.
- Check operation of the starter and stop switches when the outboard motor is in the water.

Engine

- Check the engine and engine mounting.
- Look for loose or damaged fasteners.
- Check the propeller for damage.

Checking the engine oil level

1. Put the outboard motor in an upright position (not tilted).
2. Remove oil dipstick and wipe it clean.
3. Completely insert the dipstick and remove it again.
4. Check the oil level using the dipstick to be sure the level falls between the upper and lower marks. Fill with oil if it is below the lower mark, or drain to the specified level if it is above the upper mark.

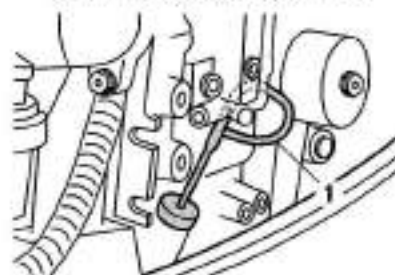

1. Oil dipstick

Operation

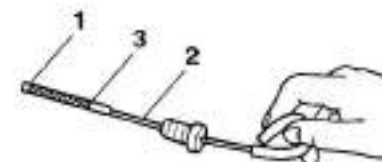

1. Lower level mark
2. Oil dipstick
3. Upper level mark

NOTE:

Be sure to completely insert the dipstick into the dipstick guide.

Filling fuel

WARNING

Gasoline and its vapors are highly flammable and explosive. Keep away from sparks, cigarettes, flames, or other sources of ignition.

1. Remove the fuel tank cap.
2. Carefully fill the fuel tank.
3. Securely close the cap after filling the tank. Wipe up any spilled fuel.

Fuel tank capacity:
24 L (6.34 US gal) (5.28 Imp.gal)

Operation

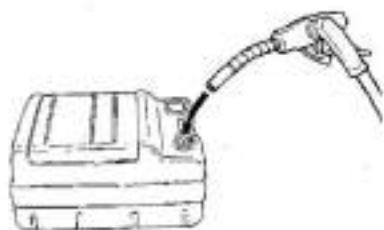

Operating engine

Feeding fuel (portable tank)

⚠ WARNING

- Before starting the engine, make sure that the boat is tightly moored and that you can steer clear of any obstructions. Be sure there are no swimmers in the water near you.
- When the air vent screw is loosened, gasoline vapor will be released. Gasoline is highly flammable, and its vapors are flammable and explosive. Refrain from smoking, and keep away from open flames and sparks while loosening the air vent screw.
- This product emits exhaust gases which contain carbon monoxide, a colorless, odorless gas which could cause brain damage or death when inhaled. Symptoms include nausea, dizziness, and drowsiness. Keep cockpit and cabin areas well ventilated. Avoid blocking exhaust outlets.

1. If there is an air vent screw on the fuel tank cap, loosen it 2 or 3 turns.



2. If there is a fuel joint on the motor, firmly connect the fuel line to the joint. Then firmly connect the other end of the fuel line to the joint on the fuel tank.

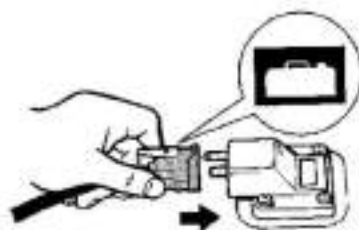
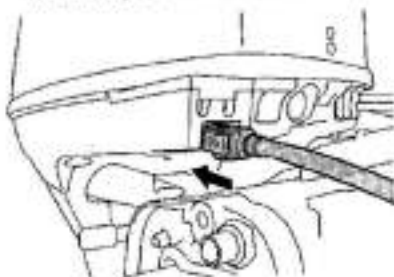

3. If a steering friction adjuster is provided on your outboard motor, securely attach the fuel line to the fuel line clamp.

NOTE:

During engine operation place the tank horizontally, otherwise fuel cannot be drawn

from the fuel tank.

4. Squeeze the primer pump with the outlet end up until you feel it become firm.



Starting engine

Starting engine

1. Place the gear shift lever in neutral.

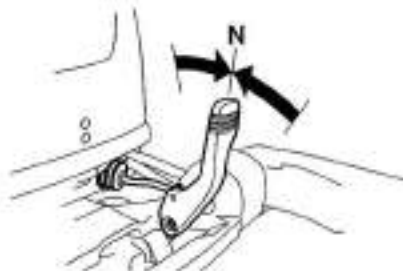

NOTE:

The start-in-gear protection device prevents the engine from starting except when in neutral.

2. Attach the engine stop switch lanyard to a secure place on your clothing, or your arm or leg. Then install the lock plate on the other end of the lanyard into the engine stop switch.

⚠ WARNING

- Attach the engine stop switch lanyard

Operation

to a secure place on your clothing, or your arm or leg while operating.

- Do not attach the lanyard to clothing that could tear loose. Do not route the lanyard where it could become entangled, preventing it from functioning.
- Avoid accidentally pulling the lanyard during normal operation. Loss of engine power means the loss of most steering control. Also, without engine power, the boat could slow rapidly. This could cause people and objects in the boat to be thrown forward.



3. Place the throttle grip in the "START" (start) position.

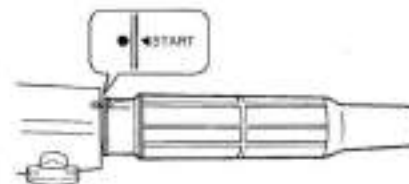

4. Pull the manual starter handle slowly until you feel resistance. Then give a strong pull straight out to crank and start the engine. Repeat if necessary.

Operation



5. After the engine starts, slowly return the manual starter handle to its original position before releasing it.

NOTE:

- When the engine is cold, it needs to be warmed up. For further information, see page 19.
- If the engine is warm and fails to start, open the throttle slightly and try to start the engine again. If the engine still fails to start, see page 44.

Warming up engine

Manual start and electric start models

1. After starting the engine, allow it to idle for 3 minutes to warm up. Failure to do so will shorten engine life.
2. Be sure the low oil pressure warning indicator goes off after starting the engine.
3. Check for a steady flow of water from the cooling water pilot hole.

CAUTION:

- If the low oil pressure warning indicator does not go off after the engine starts, stop the engine. Otherwise serious engine damage could occur. Check the oil level and add oil if necessary. Consult your dealer if the cause for the

low oil pressure warning indicator cannot be found.

- A continuous flow of water from the pilot hole shows that the water pump is pumping water through the cooling passages. If water is not flowing out of the pilot hole at all times while the engine is running, overheating and serious damage could occur. Stop the engine and check whether the cooling water inlet on the lower case or the cooling water pilot hole is blocked. Consult your dealer if the problem cannot be located and corrected.

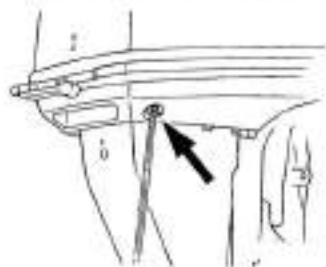

Shifting

WARNING

Before shifting, make sure there are no swimmers or obstacles in the water near you.

CAUTION:

To change the boat direction or shifting position from forward to reverse or vice-versa, first close the throttle so that the engine idles (or runs at low speeds).

Forward (tiller handle and remote control models)

Tiller control models

1. Place the throttle grip in the fully closed position.

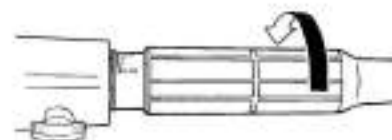

2. Move the gear shift lever quickly and firmly from neutral to forward.

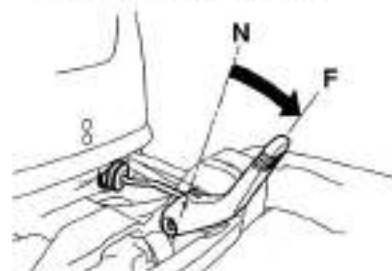

Remote control models

1. Pull up the neutral interlock trigger (if equipped) and move the remote control lever quickly and firmly from neutral to forward.

Reverse (manual tilt and hydro tilt models)

WARNING

When operating in reverse, go slowly. Do not open the throttle more than half. Otherwise the boat could become unstable,

Operation

which could result in loss of control and an accident.

Tiller control models

1. Place the throttle grip in the fully closed position.

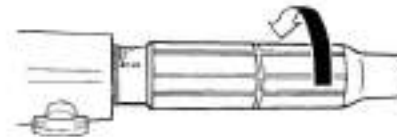

2. On models equipped with a tilt lock lever, check that it is in the lock/down position.



3. Move the gear shift lever quickly and firmly from neutral to reverse.



Operation

Remote control models

1. Check that the tilt lock lever is in the lock position.
2. Pull up the neutral interlock trigger (if equipped) and move the remote control lever quickly and firmly from neutral to reverse.

Stopping engine

Before stopping the engine, first let it cool off for a few minutes at idle or low speed. Stopping the engine immediately after operating at high speed is not recommended.

Procedure

1. Push and hold the engine stop button until the engine comes to a complete stop.

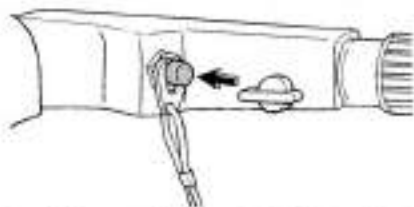

2. After stopping the engine, tighten the air vent screw on the fuel tank cap and set the fuel cock lever or knob to the closed position, if equipped.



3. Disconnect the fuel line if you are using an external fuel tank.



NOTE:

If the outboard motor is equipped with an engine stop switch lanyard, the engine can also be stopped by pulling the lanyard and removing the lock plate from the engine stop switch.

Trimming outboard motor

The trim angle of the outboard motor helps determine the position of the bow of the boat in the water. Correct trim angle will help improve performance and fuel economy while reducing strain on the engine. Correct trim angle depends upon the combination of boat, engine, and propeller. Correct trim is also affected by variables such as the load in

the boat, sea conditions, and running speed.

WARNING

Excessive trim for the operating conditions (either trim up or trim down) can cause boat instability and can make steering the boat more difficult. This increases the possibility of an accident. If the boat begins to feel unstable or is hard to steer, slow down and/or readjust the trim angle.

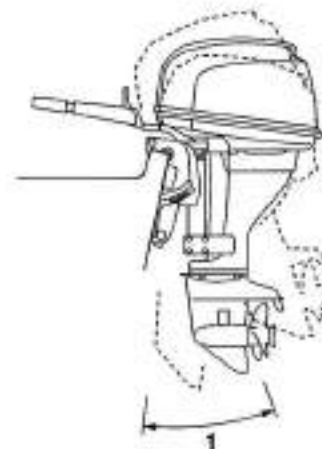

1. Trim operating angle

Adjusting trim angle for manual tilt models

There are 4 or 5 holes provided in the clamp bracket to adjust the outboard motor trim angle.

1. Stop the engine.
2. Remove the trim rod from the clamp

bracket while slightly tilting the outboard motor up.



1. Trim rod

3. Reposition the rod in the desired hole. To raise the bow ("trim-out"), move the rod away from the transom. To lower the bow ("trim-in"), move the rod toward the transom. Make test runs with the trim set to different angles to find the position that works best for your boat and operating conditions.

WARNING

- Stop the engine before adjusting the trim angle.
- Use care to avoid being pinched when removing or installing the rod.
- Use caution when trying a trim position for the first time. Increase speed gradually and watch for any signs of instability or control problems. Improper trim angle can cause loss of control.

NOTE:

The outboard motor trim angle can be changed approximately 4 degrees by shifting the trim rod one hole.

Adjusting boat trim

When the boat is on plane, a bow-up attitude

Operation

results in less drag, greater stability and efficiency. This is generally when the keel line of the boat is up about 3 to 5 degrees. With the bow up, the boat may have a greater tendency to steer to one side or the other. Compensate for this as you steer. The trim tab can also be adjusted to help offset this effect. When the bow of the boat is down, it is easier to accelerate from a standing start onto plane.

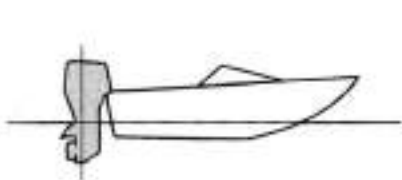

Bow Up

Too much trim-out puts the bow of the boat too high in the water. Performance and economy are decreased because the hull of the boat is pushing the water and there is more air drag. Excessive trim-out can also cause the propeller to ventilate, which reduces performance further, and the boat may "porpoise" (hop in the water), which could throw the operator and passengers overboard.

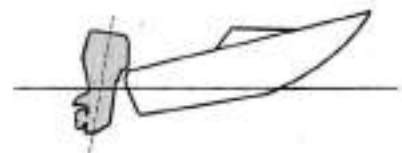

Bow Down

Too much trim-in causes the boat to "plow" through the water, decreasing fuel economy and making it hard to increase speed. Operating with excessive trim-in at higher speeds also makes the boat unstable. Resistance at the bow is greatly increased, heightening the danger of "bow steering" and making operation difficult and dangerous.

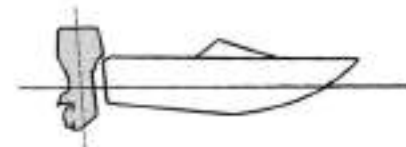

NOTE:

Depending on the type of boat, the outboard motor trim angle may have little effect on the trim of the boat when operating.

Tilting up and down

If the engine will be stopped for some time or if the boat is moored in shallows, the outboard motor should be tilted up to protect the propeller and casing from damage by collision with obstructions, and also to reduce salt corrosion.

WARNING

Be sure all people are clear of the outboard motor when tilting up and down, also be careful not to pinch any body parts between the drive unit and engine

Operation

bracket.

WARNING

Leaking fuel is a fire hazard. If there is a fuel joint on the outboard motor, disconnect the fuel line or close the fuel cock if the engine will be tilted for more than a few minutes. Otherwise fuel may leak.

CAUTION:

- Before tilting the outboard motor, stop the engine by following the procedure on page 21. Never tilt the outboard motor while the engine is running. Severe damage from overheating can result.
- Do not tilt up the engine by pushing the tiller handle (if equipped) because this could break the handle.

Procedure for tilting up (manual tilt models)

1. Place the gear shift lever in neutral.



2. Disconnect the fuel line from the outboard motor.



3. Place the tilt lock lever (if equipped) in the release/up position.

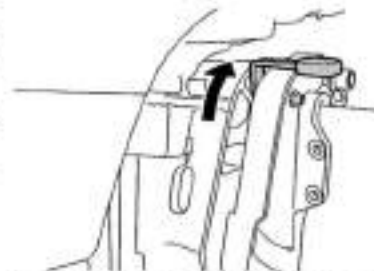

4. Pull up the shallow water lever (if equipped).
5. Hold the rear of the top cowling with one hand and tilt the engine up fully.
6. Push the tilt support knob into the clamp bracket. Or the tilt support bar will turn to the lock position automatically.



Operation

Procedure for tilting down (manual tilt models)

1. Place the tilt lock lever in the lock position.



2. Slightly tilt the engine up until the tilt support bar is automatically released.
3. Slowly tilt the engine down.

Cruising in shallow water

The outboard motor can be tilted up partially to allow operation in shallow water.

Cruising in shallow water (manual tilt models)

WARNING

- Place the gear shift in neutral before using the shallow water cruising system.
- Run the boat at the lowest possible speed when using the shallow water cruising system. The tilt lock mechanism does not work while the shallow water cruising system is being used. Hitting an underwater obstacle could cause the outboard motor to lift out of the water, resulting in loss of control.
- Do not rotate the outboard motor 180° and operate the boat in reverse. Place the gear shift in reverse to operate the

boat in reverse.

- Use extra care when operating in reverse. Too much reverse thrust can cause the outboard motor to lift out of the water, increasing the chance of accident and personal injury.
- Return the outboard motor to its normal position as soon as the boat is back in deeper water.

CAUTION:

Do not tilt the outboard motor up so that the cooling water inlet on the lower unit is above the surface of the water when setting up for and cruising in shallow water. Otherwise severe damage from overheating can result.



Procedure

1. Place the gear shift lever in neutral.

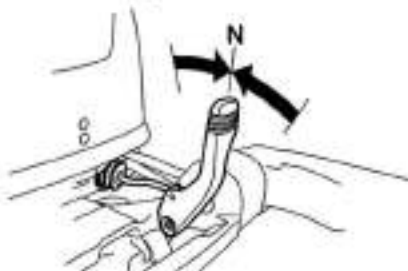

Operation

Cruising in other conditions

Cruising in salt water

After operating in salt water, wash out the cooling water passages with fresh water to prevent them from becoming clogged with salt deposits.

NOTE:

For cooling system flushing instructions, see page 28.

Cruising in turbid water

strongly recommends that you use the optional chromium-plated water pump kit (not available for some models) if you use the outboard motor in turbid (muddy) water conditions.

2. Place the tilt lock lever in the release/up position.

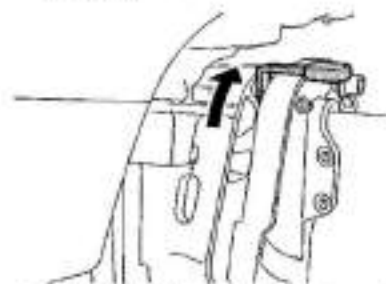

3. Slightly tilt the outboard motor up. The tilt support bar will lock automatically, supporting the outboard motor in a partially raised position.

NOTE:

This outboard motor has 2 positions for shallow water cruising.

4. To return the outboard motor to the normal running position, place the gear shift lever in neutral, then place the tilt lock lever in the lock/down position.



5. Slightly tilt the outboard motor up until the tilt support bar automatically returns to the free position.
6. Slowly lower the outboard motor to the normal position.

Maintenance

Specifications

Dimension:

- Overall length:
1151 mm (45.3 in)
- Overall width:
430 mm (16.9 in)
- Overall height L:
1275 mm (50.2 in)
- Transom height L:
550 mm (21.7 in)
- Weight (AL) L:
64.0 kg (141 lb)

Performance:

- Full throttle operating range:
5000–6000 r/min
- Maximum output:
18.4 kW @ 5500 r/min (25 HP @ 5500 r/min)
- Idling speed (in neutral):
975 ±50 r/min

Engine:

- Type:
4-stroke L
- Displacement:
498.0 cm³ (30.39 cu.in)
- Bore × stroke:
65.0 × 75.0 mm (2.56 × 2.95 in)
- Ignition system:
CDI
- Spark plug:
DPR6E8-9
- Spark plug gap:
0.8–0.9 mm (0.031–0.035 in)
- Control system:
Tiller
- Starting system:
Manual
- Starting carburetion system:
Prime start
- Valve clearance (cold engine) IN:

- 0.15–0.25 mm (0.0059–0.0098 in)
- Valve clearance (cold engine) EX:
0.25–0.35 mm (0.0098–0.0138 in)

- Alternator output:
80 W

Drive unit:

- Gear positions:
Forward-neutral-reverse
- Gear ratio:
2.08 (27/13)
- Trim and tilt system:
Manual tilt
- Propeller mark:
F

Fuel and oil:

- Recommended fuel:
Regular unleaded gasoline
- Fuel tank capacity:
24 L (6.34 US gal) (5.28 imp.gal)
- Recommended engine oil:
4-stroke outboard motor oil
- Engine oil grade API:
API SE, SF, SG, SH, SJ, SL
- Engine oil type SAE:
SAE10W30 or SAE10W40
- Lubrication:
Wet sump
- Engine oil quantity (excluding oil filter):
1.7 L (1.80 US qt) (1.50 imp.qt)
- Recommended gear oil:
Hypoid gear oil SAE#90
- Gear oil quantity:
320.0 cm³ (10.82 US oz) (11.29 imp.oz)

Tightening torque for engine:

- Spark plug:
18.0 Nm (13.3 ft-lb) (1.84 kgf-m)
- Propeller nut:
35.0 Nm (25.8 ft-lb) (3.57 kgf-m)
- Engine oil drain bolt:
28.0 Nm (20.7 ft-lb) (2.86 kgf-m)

Maintenance

- Engine oil filter:
18.0 Nm (13.3 ft-lb) (1.84 kgf-m)

Transporting and storing outboard motor

⚠ WARNING

- Leaking fuel is a fire hazard. When transporting and storing the outboard motor, close the air vent screw and fuel cock to prevent fuel from leaking.
- USE CARE when transporting fuel tank, whether in a boat or car.
- DO NOT fill fuel container to maximum capacity. Gasoline will expand considerably as it warms up and can build up pressure in the fuel container. This can cause fuel leakage and a potential fire hazard.

⚠ WARNING

Never get under the lower unit while it is tilted, even if a motor support bar is used. Severe injury could occur if the outboard motor accidentally falls.

CAUTION:

Do not use the tilt support lever or knob when trailering the boat. The outboard motor could shake loose from the tilt support and fall. If the motor cannot be trailered in the normal running position, use an additional support device to secure it in the tilt position.

The outboard motor should be trailered and stored in the normal running position. If there is insufficient road clearance in this position, then trailer the outboard motor in the tilt position using a motor support device such as a transom saver bar. Consult your

dealer for further details.



Clamp screw mounting models

When transporting or storing the outboard motor while removed from a boat, keep the outboard motor in the attitude shown.



NOTE:

Place a towel or something similar under the outboard motor to protect it from damage.

Storing outboard motor

When storing your outboard motor for prolonged periods of time (2 months or longer), several important procedures must be performed to prevent excessive damage. It is advisable to have your outboard motor serviced by an authorized dealer prior to storage. However, you, the owner, with a minimum of tools, can perform the fol-

Maintenance

lowing procedures.

CAUTION:

- To prevent problems which can be caused by oil entering the cylinder from the sump, keep the outboard motor in the attitude shown when transporting and storing it. If storing or transporting the outboard motor on its side (not upright), put it on a cushion after draining the engine oil.
- Do not place the outboard motor on its side before the cooling water has drained from it completely, otherwise water may enter the cylinder through the exhaust port and cause engine trouble.
- Store the outboard motor in a dry, well-ventilated place, not in direct sunlight.

Procedure

Flushing in a test tank

CAUTION:

Do not run the engine without supplying it with cooling water. Either the engine water pump will be damaged or the engine will be damaged from overheating. Before starting the engine, be sure to supply water to the cooling water passages.

1. Wash the outboard motor body using fresh water. For further information, see page 30.
2. Disconnect the fuel line from the motor or shut off the fuel cock, if equipped.
3. Remove the engine top cowling and silencer cover. Remove the propeller.
4. Install the outboard motor on the test tank. Fill the tank with fresh water to

above the level of the anti-cavitation plate.

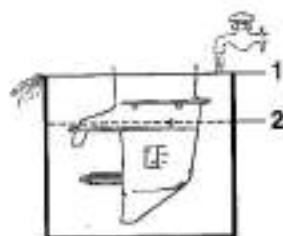

1. Water surface
2. Lowest water level

CAUTION:

If the fresh water level is below the level of the anti-cavitation plate, or if the water supply is insufficient, engine seizure may occur.

5. Cooling system flushing is essential to prevent the cooling system from clogging up with salt, sand, or dirt. In addition, fogging/lubricating of the engine is mandatory to prevent excessive engine damage due to rust. Perform the flushing and fogging at the same time.

WARNING

- Do not touch or remove electrical parts when starting or during operation.
 - Keep hands, hair, and clothes away from the flywheel and other rotating parts while the engine is running.
6. Run the engine at a fast idle for a few minutes in neutral position.
 7. Just prior to turning off the engine, quickly spray "Fogging Oil" alternately into each carburetor or the fogging hole of

the silencer cover, if equipped. When properly done, the engine will smoke excessively and almost stall.

8. Remove the outboard motor from the test tank.
9. Install the silencer cover/cap of fogging hole and top cowling.
10. If the "Fogging Oil" is not available, run the engine at a fast idle until the fuel system becomes empty and the engine stops.
11. Drain the cooling water completely out of the motor. Clean the body thoroughly.
12. If the "Fogging Oil" is not available, remove the spark plug(s). Pour a teaspoonful of clean engine oil into each cylinder. Crank several times manually. Replace the spark plug(s).
13. Drain the fuel from the fuel tank.

NOTE:

Store the fuel tank in a dry, well-ventilated place, not in direct sunlight.

Lubrication (except oil injection models)

1. Grease the spark plug threads and install the spark plug(s) and torque to proper specification. For information on spark plug installation, see page 33.
2. Change the gear oil. For instructions, see page 40. Inspect the oil for the presence of water that indicates a leaky seal. Seal replacement should be performed by an authorized dealer prior to use.
3. Grease all grease fittings. For further details, see page 33.

Cleaning the outboard motor

After use, wash the exterior of the outboard motor with fresh water. Flush the cooling

system with fresh water.



NOTE:

For cooling system flushing instructions, see page 26.

Checking painted surface of motor

Check the motor for scratches, nicks, or flaking paint. Areas with damaged paint are more likely to corrode. If necessary, clean and paint the areas. A touch-up paint is available from your dealer.

Periodic maintenance

WARNING

Be sure to turn off the engine when you perform maintenance unless otherwise specified. If you or the owner is not familiar with machine servicing, this work should be done by your Hitec dealer or other qualified mechanic.

Replacement parts

If replacement parts are necessary, use only genuine parts or parts of the same type and of equivalent strength and materials. Any part of inferior quality may malfunction, and the resulting loss of control could endanger the operator and passengers. Genuine parts and accessories are available from your dealer.

Maintenance

Maintenance chart

Frequency of maintenance operations may be adjusted according to the operating conditions, but the following table gives general guidelines. Refer to the sections in this chapter for explanations of each owner-specific action.

NOTE:

When operating in salt water, turbid or muddy water, the engine should be flushed with clean water after each use.

The "●" symbol indicates the check-ups which you may carry out yourself.

The "○" symbol indicates work to be carried out by your dealer.

Item	Actions	Initial		Every	
		10 hours (1 month)	50 hours (3 months)	100 hours (6 months)	200 hours (1 year)
Anode(s) (external)	Inspection / replacement		●/○	●/○	
Anode(s) (internal)	Inspection / replacement				○
Cooling water passages	Cleaning		●	●	
Cowling clamp	Inspection				●
Fuel filter (can be disassembled)	Inspection / cleaning	●	●	●	
Fuel system	Inspection	●	●	●	
Fuel tank (portable tank)	Inspection / cleaning				●
Gear oil	Change	●		●	
Greasing points	Greasing			●	
Idling speed (carburetor models)	Inspection	●/○		●/○	
Propeller and cotter pin	Inspection / replacement		●	●	
Shift link / shift cable	Inspection / adjustment				○
Thermostat	Inspection / replacement				○
Throttle link / throttle cable / throttle pick-up lining	Inspection / adjustment				○
Water pump	Inspection / replacement				○
Engine oil	Inspection / change	●		●	

Maintenance

Item	Actions	Initial		Every	
		10 hours (1 month)	50 hours (3 months)	100 hours (6 months)	200 hours (1 year)
Oil filter (cartridge)	Change				○
Spark plug(s)	Cleaning / adjustment / replacement	●			●
Timing belt	Inspection / replacement			○	○
Valve clearance (CHC, CHV)	Inspection / adjustment	○		○	

Maintenance chart (additional)

Item	Actions	Every	
		500 hours (2.5 years)	1000 hours (5 years)
Timing belt	Replacement		○
Exhaust guide, exhaust manifold	Inspection / replacement		○

NOTE:

When using lead or high-sulfur gasoline, inspecting valve clearance may be required more frequently than every 500 hours.

Maintenance

Greasing

grease A (water resistant grease)

grease D (corrosion resistant grease; for propeller shaft)

• F20

• F25

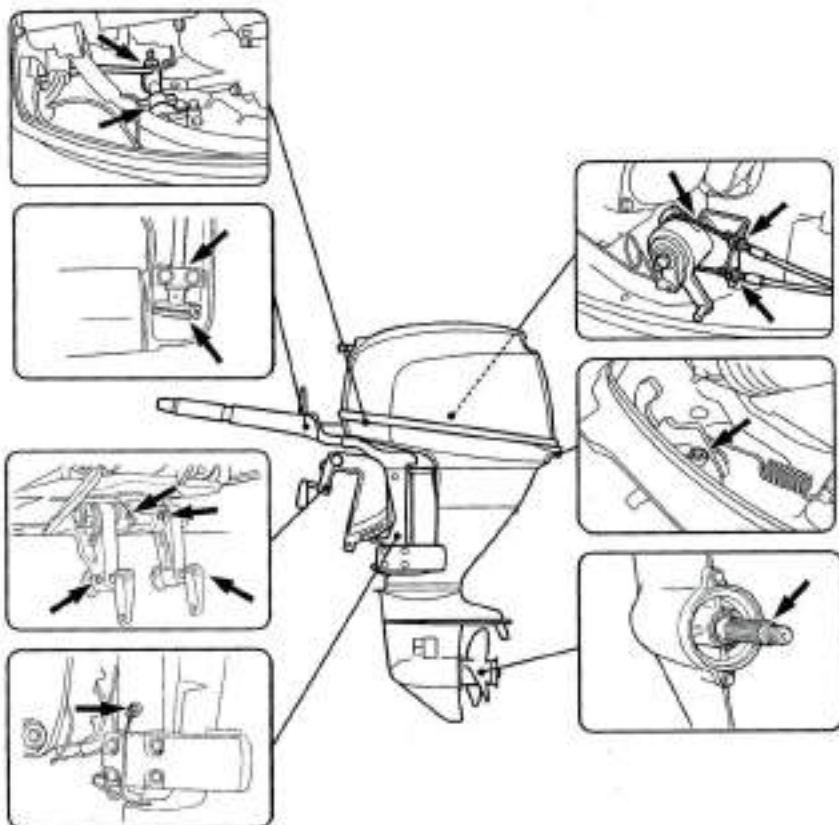

Cleaning and adjusting spark plug

WARNING

When removing or installing a spark plug, be careful not to damage the insulator. A

damaged insulator could allow external sparks, which could lead to explosion or fire.

The spark plug is an important engine component and is easy to inspect. The condition

Maintenance

of the spark plug can indicate something about the condition of the engine. For example, if the center electrode porcelain is very white, this could indicate an intake air leak or carburetion problem in that cylinder. Do not attempt to diagnose any problems yourself. Instead, take the outboard motor to a dealer. You should periodically remove and inspect the spark plug because heat and deposits will cause the spark plug to slowly break down and erode. If electrode erosion becomes excessive, or if carbon and other deposits are excessive, you should replace the spark plug with another of the correct type.

Standard spark plug:
DPR6EB-9

Before fitting the spark plug, measure the electrode gap with a wire thickness gauge; adjust the gap to specification if necessary.

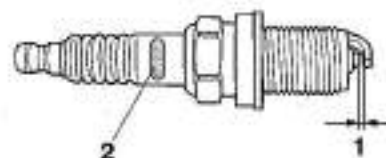

1. Spark plug gap
2. Spark plug I.D. mark (NGK)

Spark plug gap:
0.8–0.9 mm (0.031–0.035 in)

When fitting the plug, always clean the gasket surface and use a new gasket. Wipe off any dirt from the threads and screw in the

spark plug to the correct torque.

Spark plug torque:
18.0 Nm (13.3 ft-lb) (1.84 kgf-m)

NOTE:

If a torque-wrench is not available when you are fitting a spark plug, a good estimate of the correct torque is 1/4 to 1/2 a turn past finger-tight. Have the spark plug adjusted to the correct torque as soon as possible with a torque-wrench.

Checking fuel system

WARNING

Gasoline and its vapors are highly flammable and explosive. Keep away from sparks, cigarettes, flames, or other sources of ignition.

WARNING

Leaking fuel can result in fire or explosion.

- Check for fuel leakage regularly.
- If any fuel leakage is found, the fuel system must be repaired by a qualified mechanic. Improper repairs can make the outboard unsafe to operate.

Check the fuel lines for leaks, crack, or malfunction. If a problem is found, your dealer or other qualified mechanic should repair it immediately.

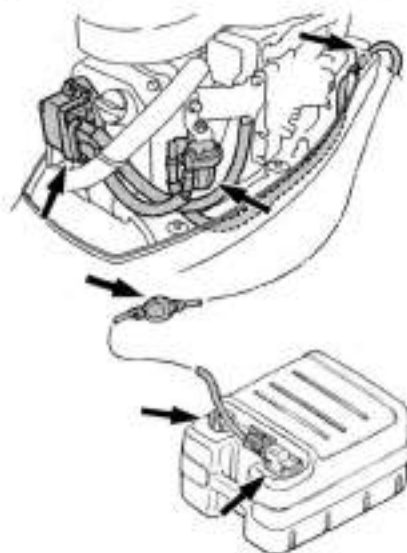

Checkpoints

- Fuel system parts leakage
- Fuel line joint leakage
- Fuel line cracks or other damage
- Fuel connector leakage

Inspecting fuel filter

⚠ WARNING

Gasoline is highly flammable, and its vapors are flammable and explosive.

- If you have any question about properly doing this procedure, consult your dealer.
- Do not perform this procedure on a hot or running engine. Allow the engine to cool.
- There will be fuel in the fuel filter. Keep away from sparks, cigarettes, flames or other sources of ignition.
- This procedure will allow some fuel to

spill. Catch fuel in a rag. Wipe up any spilled fuel immediately.

- The fuel filter must be reassembled carefully with the O-ring, filter cup, and hoses in place. Improper assembly or replacement could result in a fuel leak, which could result in a fire or explosion hazard.

Cleaning fuel filter

1. Remove the nut holding the fuel filter assembly if equipped.

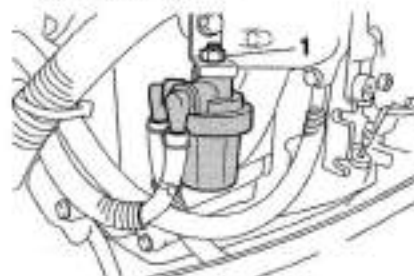

1. Nut

2. Unscrew the filter cup, catching any spilled fuel in a rag.
3. Remove the filter element, and wash it in solvent. Allow it to dry. Inspect the filter element and O-ring to make sure they are in good condition. Replace them if necessary. If any water is found in the fuel, the portable fuel tank or other fuel tanks should be checked and cleaned.

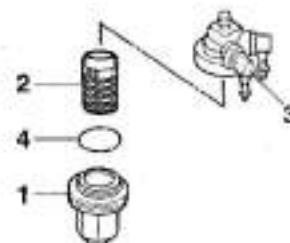

1. Filter cup
2. Filter element
3. Filter housing
4. O-ring

4. Reinstall the filter element in the cup. Make sure the O-ring is in position in the cup. Firmly screw the cup onto the filter housing.
5. Attach the filter assembly to the bracket so that the fuel hoses are attached to the filter assembly.
6. Run the engine and check the filter and lines for leaks.

Inspecting idling speed

⚠ WARNING

- Do not touch or remove electrical parts when starting or during operation.
- Keep hands, hair, and clothes away from the flywheel and other rotating parts while the engine is running.

CAUTION:

This procedure must be performed while the outboard motor is in the water. A flushing attachment or test tank can be used.

A diagnostic tachometer should be used for this procedure. Results may vary depending

on whether testing is conducted with the flushing attachment, in a test tank, or with the outboard motor in the water.

1. Start the engine and allow it to warm up fully in neutral until it is running smoothly.

NOTE:

Correct idling speed inspection is only possible if the engine is fully warmed up. If not warmed up fully, the idle speed will measure higher than normal. If you have difficulty verifying the idle speed, or the idle speed requires adjustment, consult a dealer or other qualified mechanic.

2. Verify whether the idle speed is set to specification. For idle speed specifications, see page 27.

Changing engine oil

⚠ WARNING

- Avoid draining the engine oil immediately after stopping the engine. The oil is hot and should be handled with care to avoid burns.
- Be sure the outboard motor is securely fastened to the transom or a stable stand.

CAUTION:

- Do not overfill the oil, and be sure the outboard motor is upright (not tilted) when checking and changing the engine oil.
- If the oil level is above the upper level mark, drain until the level meets the specified capacity. Overfilling the oil

Maintenance

could cause leakage or damage.

CAUTION:

Change the engine oil after the first 10 hours of operation, and every 100 hours or at 6-month intervals thereafter. Otherwise the engine will wear quickly.

NOTE:

Change the engine oil when the oil is still warm.

1. Put the outboard motor in an upright position (not tilted).



2. Prepare a suitable container that holds a larger amount than the engine oil capacity. Loosen and remove the drain screw while holding the container under the drain hole. Then remove the oil filler cap. Let the oil drain completely. Wipe up any spilled oil immediately.

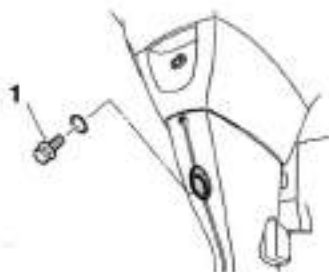

1. Drain screw

3. Put a new gasket on the oil drain screw. Apply a light coat of oil to the gasket and install the drain screw.

Drain screw tightening torque:
28.0 Nm (20.7 ft-lb) (2.86 kgf-m)

NOTE:

If a torque wrench is not available when you are installing the drain screw, finger tighten the screw just until the gasket comes into contact with the surface of the drain hole. Then tighten 1/4 to 1/2 turn more. Tighten the drain screw to the correct torque with a torque wrench as soon as possible.

4. Add the correct amount of oil through the filler hole. Install the filler cap.

Recommended engine oil:
4-stroke outboard motor oil
Engine oil quantity (excluding oil filter):
1.7 L (1.80 US qt) (1.50 Imp. qt)

Maintenance

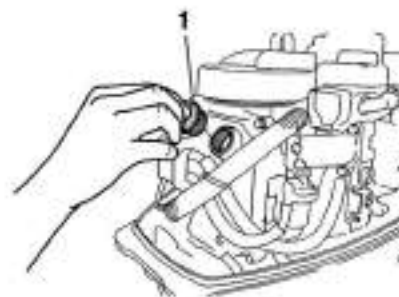

1. Oil filler cap

5. Start the engine and watch to make sure the low oil pressure warning indicator (if equipped) turns off. Make sure that there are no oil leaks.

CAUTION:

If the low oil pressure warning indicator does not turn off or if there are oil leaks, stop the engine and find the cause. Continued operation with a problem could cause severe engine damage. Consult your dealer if the problem can not be located and corrected.

6. Turn off the engine and wait 3 minutes. Recheck the oil level using the dipstick to be sure the level falls between the upper and lower marks. Fill with oil if it is below the lower mark, or drain to the specified level if it is above the upper mark.



7. Dispose of used oil according to local regulations.

NOTE:

- For more information on the disposal of used oil, consult your dealer.
- Change the oil more often when operating the engine under adverse conditions such as extended trolling.

Checking wiring and connectors

- Check that each grounding wire is properly secured.
- Check that each connector is engaged securely.

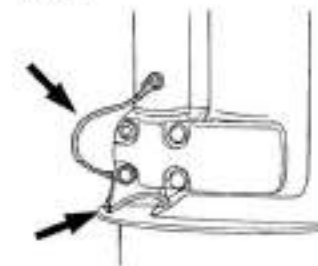

Exhaust leakage

Start the engine and check that no exhaust leaks from the joints between the exhaust cover, cylinder head, and body cylinder.

Maintenance

Water leakage

Start the engine and check that no water leaks from the joints between the exhaust cover, cylinder head, and body cylinder.

Engine oil leakage

Check for oil leaks on the around the engine.

NOTE:

If any leaks are found, consult your dealer.

Checking propeller

⚠ WARNING

You could be seriously injured if the engine accidentally starts when you are near the propeller.

- Before inspecting, removing, or installing the propeller, remove the spark plug caps from the spark plugs. Also, place the shift control in neutral, turn the main switch to "OFF" (off) and remove the key, and remove the lanyard from the engine stop switch. Turn off the battery cut-off switch if your boat has one.
- Do not use your hand to hold the propeller when loosening or tightening the propeller nut. Put a wood block between the anti-cavitation plate and the propeller to prevent the propeller from turning.

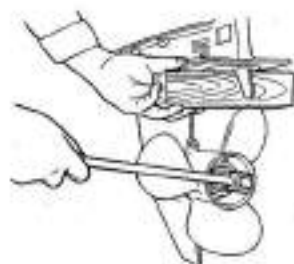
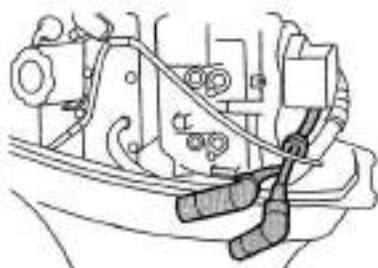

Checkpoints

- Check each of the propeller blades for wear, erosion from cavitation or ventilation, or other damage.
- Check the propeller shaft for damage.
- Check the splines / shear pin for wear or damage.
- Check for fish line tangled around the propeller shaft.



- Check the propeller shaft oil seal for damage.

Maintenance

NOTE:

If the shear pin equipped: It is designed to break if the propeller hits a hard underwater obstacle to help protect the propeller and drive mechanism. The propeller will then spin freely on the shaft. If this happens, the shear pin must be replaced.

Removing the propeller

Spline models

1. Straighten the cotter pin and pull it out using a pair of pliers.
2. Remove the propeller nut, washer, and spacer (if equipped).

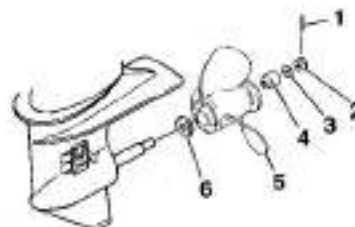

1. Cotter pin
2. Propeller nut
3. Washer
4. Spacer
5. Propeller
6. Thrust washer

3. Remove the propeller and thrust washer.

Installing the Propeller

Spline models

CAUTION:

- Be sure to install the thrust washer before installing the propeller, otherwise

the lower case and propeller boss could be damaged.

- Be sure to use a new cotter pin and bend the ends over securely. Otherwise the propeller could come off during operation and be lost.

1. Apply marine grease or a corrosion resistant grease to the propeller shaft.
2. Install the spacer (if equipped), thrust washer, and propeller on the propeller shaft.
3. Install the spacer (if equipped) and the washer. Tighten the propeller nut to the specified torque.
4. Align the propeller nut with the propeller shaft hole. Insert a new cotter pin in the hole and bend the cotter pin ends.

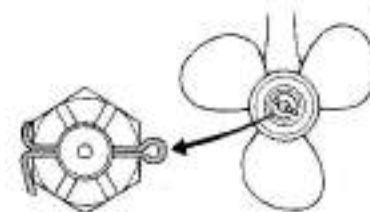

NOTE:

If the propeller nut does not align with the propeller shaft hole after tightening to the specified torque, tighten the nut further to align it with the hole.

Changing gear oil

⚠ WARNING

- Be sure the outboard motor is securely fastened to the transom or a stable stand. You could be severely injured if

Maintenance

the outboard motor falls on you.

- Never get under the lower unit while it is tilted, even when the tilt support lever or knob is locked. Severe injury could occur if the outboard motor accidentally falls.

1. Tilt the outboard motor so that the gear oil drain screw is at the lowest point possible.
2. Place a suitable container under the gear case.
3. Remove the gear oil drain screw.



1. Gear oil drain screw
2. Oil level plug

NOTE:

If the magnetic gear oil drain screw equipped: remove all metal particles from the screw before installing it.

4. Remove the oil level plug to allow the oil to drain completely.

CAUTION:

Inspect the used oil after it has been drained. If the oil is milky, water is getting into the gear case which can cause gear damage. Consult a dealer for repair of the lower unit seals.

NOTE:

For disposal of used oil consult your dealer.

5. With the outboard motor in a vertical position, and using a flexible or pressurized filling device, inject the gear oil into the gear oil drain screw hole.

Recommended gear oil:
Hypoid gear oil SAE#90
Gear oil quantity:
320.0 cm³ (10.82 US oz) (11.29 Imp. oz)

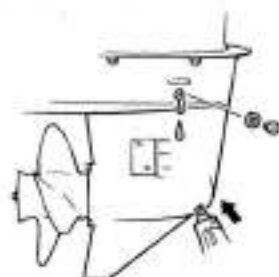

6. When the oil begins to flow out of the oil level plug hole, insert and tighten the oil level plug.
7. Insert and tighten the gear oil drain screw.

Cleaning fuel tank

⚠ WARNING

Gasoline is highly flammable, and its vapors are flammable and explosive.

- If you have any question about properly doing this procedure, consult your dealer.
- Keep away from sparks, cigarettes, flames, or other sources of ignition

when cleaning the fuel tank.

- Remove the fuel tank from the boat before cleaning it. Work only outdoors in an area with good ventilation.
- Wipe up any spilled fuel immediately.
- Reassemble the fuel tank carefully. Improper assembly can result in a fuel leak, which could result in a fire or explosion hazard.
- Dispose of old gasoline according to local regulations.

1. Empty the fuel tank into an approved container.
2. Pour a small amount of suitable solvent into the tank. Install the cap and shake the tank. Drain the solvent completely.
3. Remove the screws holding the fuel joint assembly. Pull the assembly out of the tank.

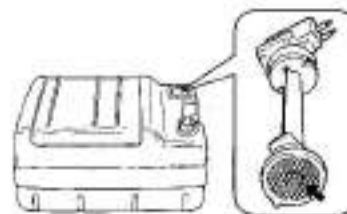

4. Clean the filter (located on the end of the suction pipe) in a suitable cleaning solvent. Allow the filter to dry.
5. Replace the gasket with a new one. Reinstall the fuel joint assembly and tighten the screws firmly.

Inspecting and replacing anode(s)

The outboard motors are protected from corrosion by sacrificial anodes. Inspect the external anodes periodically. Remove scales from the surfaces of the anodes. Consult a

Maintenance

dealer for replacement of external anodes.

CAUTION:

Do not paint anodes, as this would render them ineffective.

NOTE:

Inspect ground leads attached to external anodes on equipped models. Consult a dealer for inspection and replacement of internal anodes attached to the power unit.

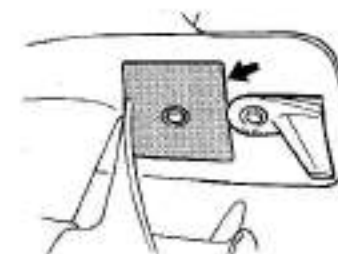

Checking top cowling

Check the fitting of the top cowling by pushing it with both hands. If it is loose have it repaired by your dealer.



Coating the boat bottom

A clean hull improves boat performance. The

Maintenance

boat bottom should be kept as clean of marine growth as possible. If necessary, the boat bottom can be coated with an anti-fouling paint approved for your area to inhibit marine growth.

Do not use anti-fouling paint which includes copper or graphite. These paints can cause more rapid engine corrosion.

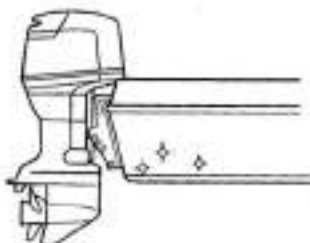

Trouble Recovery

OUTBOARD

Troubleshooting

A problem in the fuel, compression, or ignition systems can cause poor starting, loss of power, or other problems. This section describes basic checks and possible remedies, and covers all outboard motors.

Therefore some items may not apply to your model.

If your outboard motor requires repair, bring it to your dealer.

If the engine trouble warning indicator is flashing, consult your dealer.

Starter will not operate.

Q. Is battery capacity weak or low?

A. Check battery condition. Use battery of recommended capacity.

Q. Are battery connections loose or corroded?

A. Tighten battery cables and clean battery terminals.

Q. Is fuse for electric start relay or electric circuit blown?

A. Check for cause of electric overload and repair. Replace fuse with one of correct amperage.

Q. Are starter components faulty?

A. Have serviced by a dealer.

Q. Is shift lever in gear?

A. Shift to neutral.

Engine will not start (starter operates).

Q. Is fuel tank empty?

A. Fill tank with clean, fresh fuel.

Q. Is fuel contaminated or stale?

A. Fill tank with clean, fresh fuel.

Q. Is fuel filter clogged?

A. Clean or replace filter.

Q. Is starting procedure incorrect?

A. See page 18.

Q. Has fuel pump malfunctioned?

A. Have serviced by a dealer.

Q. Are spark plug(s) fouled or of incorrect type?

A. Inspect spark plug(s). Clean or replace with recommended type.

Q. Are spark plug cap(s) fitted incorrectly?

A. Check and re-fit cap(s).

Q. Is ignition wiring damaged or poorly connected?

A. Check wires for wear or breaks. Tighten all loose connections. Replace worn or broken wires.

Q. Are ignition parts faulty?

A. Have serviced by a dealer.

Q. Is engine stop switch lanyard not attached?

A. Attach lanyard.

Q. Are engine inner parts damaged?

A. Have serviced by a dealer.

Engine idles irregularly or stalls.

Q. Are spark plug(s) fouled or of incorrect type?

A. Inspect spark plug(s). Clean or replace with recommended type.

Trouble Recovery

Q. Is fuel system obstructed?

A. Check for pinched or kinked fuel line or other obstructions in fuel system.

Q. Is fuel contaminated or stale?

A. Fill tank with clean, fresh fuel.

Q. Is fuel filter clogged?

A. Clean or replace filter.

Q. Have ignition parts failed?

A. Have serviced by a dealer.

Q. Has warning system activated?

A. Find and correct cause of warning.

Q. Is spark plug gap incorrect?

A. Inspect and adjust as specified.

Q. Is ignition wiring damaged or poorly connected?

A. Check wires for wear or breaks. Tighten all loose connections. Replace worn or broken wires.

Q. Is specified engine oil not being used?

A. Check and replace oil as specified.

Q. Is thermostat faulty or clogged?

A. Have serviced by a dealer.

Q. Are carburetor adjustments incorrect?

A. Have serviced by a dealer.

Q. Is fuel pump damaged?

A. Have serviced by a dealer.

Q. Is air vent screw on fuel tank closed?

A. Open air vent screw.

Q. Is choke knob pulled out?

A. Return to home position.

Q. Is motor angle too high?

A. Return to normal operating position.

Q. Is carburetor clogged?

A. Have serviced by a dealer.

Q. Is fuel joint connection incorrect?

A. Connect correctly.

Q. Is throttle valve adjustment incorrect?

A. Have serviced by a dealer.

Q. Is battery cable disconnected?

A. Connect securely.

Warning buzzer sounds or indicator lights.

Q. Is cooling system clogged?

A. Check water intake for restriction.

Q. Is engine oil level low?

A. Fill oil tank with specified engine oil.

Q. Is heat range of spark plug incorrect?

A. Inspect spark plug and replace it with recommended type.

Q. Is specified engine oil not being used?

A. Check and replace oil with specified type.

Q. Is engine oil contaminated or deteriorated?

A. Replace oil with fresh, specified type.

Q. Is oil filter clogged?

A. Have serviced by a dealer.

Q. Has oil feed/injection pump malfunctioned?

A. Have serviced by a Hidea dealer.

Q. Is load on boat improperly distributed?

A. Distribute load to place boat on an even plane.

Q. Is water pump or thermostat faulty?

A. Have serviced by a dealer.

Q. Is there excess water in fuel filter cup?

A. Drain filter cup.

Engine power loss.

Q. Is propeller damaged?

A. Have propeller repaired or replaced.

Q. Is propeller pitch or diameter incorrect?

A. Install correct propeller to operate outboard at its recommended speed (r/min) range.

Q. Is trim angle incorrect?

A. Adjust trim angle to achieve most efficient operation.

Q. Is motor mounted at incorrect height on transom?

A. Have motor adjusted to proper transom height.

Q. Has warning system activated?

A. Find and correct cause of warning.

Q. Is boat bottom fouled with marine growth?

A. Clean boat bottom.

Q. Are spark plug(s) fouled or of incorrect type?

A. Inspect spark plug(s). Clean or replace with recommended type.

Trouble Recovery

Q. Are weeds or other foreign matter tangled on gear housing?

A. Remove foreign matter and clean lower unit.

Q. Is fuel system obstructed?

A. Check for pinched or kinked fuel line or other obstructions in fuel system.

Q. Is fuel filter clogged?

A. Clean or replace filter.

Q. Is fuel contaminated or stale?

A. Fill tank with clean, fresh fuel.

Q. Is spark plug gap incorrect?

A. Inspect and adjust as specified.

Q. Is ignition wiring damaged or poorly connected?

A. Check wires for wear or breaks. Tighten all loose connections. Replace worn or broken wires.

Q. Have electrical parts failed?

A. Have serviced by a dealer.

Q. Is specified fuel not being used?

A. Replace fuel with specified type.

Q. Is specified engine oil not being used?

A. Check and replace oil with specified type.

Q. Is thermostat faulty or clogged?

A. Have serviced by a dealer.

Q. Is air vent screw closed?

A. Open the air vent screw.

Q. Is fuel pump damaged?

A. Have serviced by a dealer.

Trouble Recovery

Q. Is fuel joint connection incorrect?

A. Connect correctly.

Q. Is heat range of spark plug incorrect?

A. Inspect spark plug and replace it with recommended type.

Q. Is high pressure fuel pump drive belt broken?

A. Have serviced by a dealer.

Q. Is engine not responding properly to shift lever position?

A. Have serviced by a dealer.

Engine vibrates excessively.

Q. Is propeller damaged?

A. Have propeller repaired or replaced.

Q. Is propeller shaft damaged?

A. Have serviced by a dealer.

Q. Are weeds or other foreign matter tangled on propeller?

A. Remove and clean propeller.

Q. Is motor mounting bolt loose?

A. Tighten bolt.

Q. Is steering pivot loose or damaged?

A. Tighten or have serviced by a dealer.

Temporary action in emergency

Impact damage

WARNING

The outboard motor can be seriously

damaged by a collision while operating or trailering. Damage could make the outboard motor unsafe to operate.

If the outboard motor hits an object in the water, follow the procedure below.



1. Stop the engine immediately.
2. Inspect the control system and all components for damage. Also inspect the boat for damage.
3. Whether damage is found or not, return to the nearest harbor slowly and carefully.
4. Have a dealer inspect the outboard motor before operating it again.

Starter will not operate

If the starter mechanism does not operate (the engine cannot be cranked with the starter), the engine can be started with an emergency starter rope.

WARNING

- Use this procedure only in an emergency and only to return to port for repairs.
- When the emergency starter rope is used to start the engine, the start-in-gear protection device does not operate. Make sure the remote control lever is in neutral. Otherwise the boat could unexpectedly start to move, which

Trouble Recovery

could result in an accident.

- Attach the engine stop switch lanyard to a secure place on your clothing, or your arm or leg while operating.
- Do not attach the lanyard to clothing that could tear loose. Do not route the cord where it could become entangled, preventing it from functioning.
- Avoid accidentally pulling the lanyard during normal operation. Loss of engine power means the loss of most steering control. Also, without engine power, the boat could slow rapidly. This could cause people and objects in the boat to be thrown forward.
- Be sure no one is standing behind you when pulling the starter rope. It could whip behind you and injure someone.
- An unguarded, rotating flywheel is very dangerous. Keep loose clothing and other objects away when starting the engine. Use the emergency starter rope only as instructed. Do not touch the flywheel or other moving parts when the engine is running. Do not install the starter mechanism or top cowling after the engine is running.
- Do not touch the ignition coil, spark plug wire, spark plug cap, or other electrical components when starting or operating the motor. You could get an electrical shock.

Emergency starting engine

1. Remove the top cowling.
2. Remove the start-in-gear protection cable from the starter after removing the clip and the screw, if the cable is equipped.

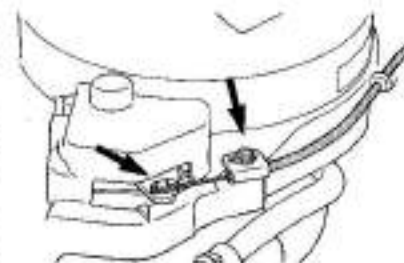

3. Remove the starter/flywheel cover after removing the 4 bolts. Disconnect the leads for the warning indicator.

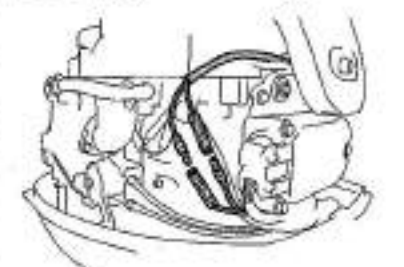
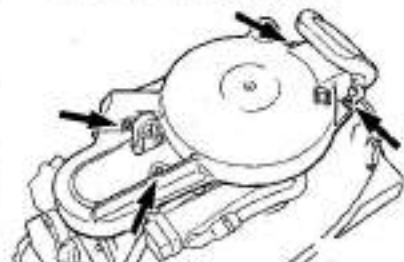

4. Prepare the engine for starting. For further information, see page 18. Be sure the engine is in neutral and that the engine stop switch lanyard lock plate is attached to the engine stop switch. The main switch must be "ON" (on), if equipped.

Trouble Recovery

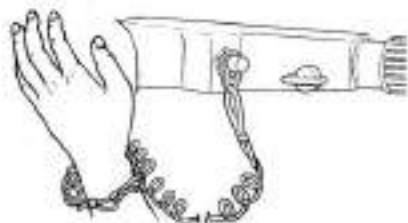

5. Insert the knotted end of the emergency starter rope into the notch in the flywheel rotor and wind the rope around the flywheel several turns clockwise.
6. Pull the rope slowly until resistance is felt.
7. Give a strong pull straight out to crank and start the engine. Repeat if necessary.



Treatment of submerged motor

If the outboard motor is submerged, immediately take it to a dealer. Otherwise some corrosion may begin almost immediately.

If you cannot immediately take the outboard motor to a dealer, follow the procedure below in order to minimize engine damage.

Procedure

1. Thoroughly wash away mud, salt, seaweed, and so on, with fresh water.
2. Remove the spark plug(s), then face the spark plug holes downward to allow any water, mud, or contaminants to drain.
3. Drain the fuel from the carburetor, fuel filter, and fuel line. Drain the engine oil completely.
4. Fill the sump with the fresh engine oil.

Engine oil capacity:
1.7 L (1.80 US qt) (1.50 Imp. qt)

5. Feed engine fogging oil or engine oil through the carburetor(s) and spark plug holes while cranking the engine with the manual starter or emergency starter rope.
6. Take the outboard motor to a dealer as soon as possible.

CAUTION:

Do not attempt to run the outboard motor until it has been completely inspected.