

ALASTRON®

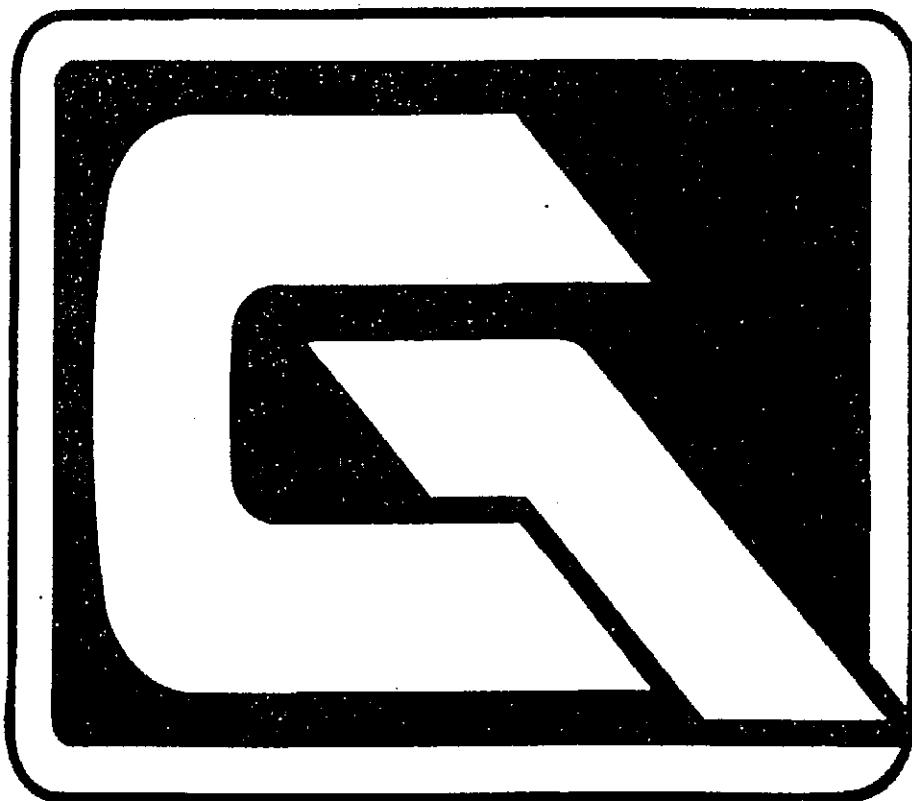

OUTBOARD BOAT Owner's Manual

IMPORTANT

Six things you should do now!

- 1 Read and understand the Glastron Limited Warranty.
- 2 Be sure your Warranty Registration Card is completed.
- 3 Read your Owner's Manual and all other literature that accompanies your boat.
- 4 Acquire necessary and recommended safety equipment.
- 5 Comply with all State and Federal registration requirements.
- 6 Take advantage of boating education/safety courses and publications.

TABLE OF CONTENTS

GENERAL INFORMATION.....	1
WARRANTY.....	2
SAFETY ON BOARD.....	3
SAFETY AFLOAT.....	7
ELECTRICAL SYSTEMS.....	12
WIRING DIAGRAM.....	14
GETTING UNDERWAY.....	16
LOADING.....	17
FUELING.....	18
STARTING THE ENGINES.....	21
ACCELERATING.....	22
MOORING LINES.....	23
PREVENTATIVE MAINTENANCE.....	26
TROUBLE SHOOTING.....	28
WINTER LAY-UP.....	32
DRY STORAGE.....	33
GENERAL HOUSEKEEPING.....	34
APPEARANCE/CARE.....	35
GELCOAT/FIBERGLASS.....	35
CARPETING.....	37
NAUTICAL TERMS.....	40

General Information/Introduction

Welcome Aboard

Your new Glastron boat has been designed and manufactured to provide you with the ultimate in boating pleasure. Glastron boats are manufactured with the finest of materials and workmanship found in the boating industry. During the manufacturing process Glastron has provided several different tests and inspections to insure seaworthiness and beauty.

Standards and Construction

The Standards and Construction of all Glastron boats meet or exceed U. S. Coast Guard requirements and the National Marine Manufacturers Association (NMMA) recommendations concerning:

- * Navigational Lights
- * Factory Installed Fuel Systems
- * Engine and Fuel Tank Compartment Ventilation
- * Basic and Level Flotation (depending on length of boat)
- * Steering System

Construction of the hull begins with multiple layers of fiberglass, bonded with polyester resin, providing a seaworthy hull. The interior of your Glastron also includes MICA's, marine grade vinyls and carpets. Reasonable care and maintenance will insure that the boat will retain an attractive appearance as the years go by.

Owner's Manuals

Your owner's manual should be used as a guide to familiarize yourself with all the systems and components in your Glastron. The procedures in this manual will help you with the operation and maintenance of your boat. The information may be general in nature in some cases and detailed in others. The suppliers of some of the more complex components such as engines, pumps, generators, refrigerator, air conditioner, radio and electronics, supply their own instructional manuals which are included in the Owner's Manual zipper bag.

The suppliers of these products maintain their own manufacturer's warranty and service facilities. One of the first orders of business should be to fill out each warranty card and mail it back to the manufacturer to register

your ownership. A form regarding this information is provided at the end of this section for your convenience. This form should be placed in a safe place at home; not aboard the boat.

Additional Information

Your Glastron dealer is always ready to help you keep your boat in top condition. There are areas that you the owner may not be able to service with today's complex technology. Your dealer has access to factory trained specialists when they are needed for such equipment as air conditioning, engines, and stern drives. Basic servicing can be handled by you such as checking and changing the engine oil, checking the condition of hoses, bilge pumps, and electrical connections to name a few. It is important to know when to go to your Glastron dealer for factory trained expert assistance. We suggest you develop a regular plan of routine maintenance on the engine(s), and hull, to keep your boat operation reliable and efficient. A schedule of cleaning and waxing of the exterior will help keep the appearance like new. Glastron recommends that the boat skipper and one other person who normally accompanies the skipper, enroll in a boating safety course. Educational programs are sponsored by organizations such as the U.S. Power Squadrons, U.S. Coast Guard Auxiliary, and the American Red Cross. See your Glastron dealer about special courses available in your area.

For detailed information contact:

Boat U.S. Foundation for Boating Safety
Hotline

Most states also offer safe boating courses. Call 800/336-BOAT to find out what's offered in your state.

Skipper's Course

G.P.O. Superintendent of Documents
Washington, D.C. 20012

United States Power Squadrons
P.O. Box 30423
Raleigh, N.C. 27617

American Red Cross
Local address

General Information/Warranty

There are many good boating publications that have information about your area and what other boaters are doing, such as clubs and other activities.

NMMA Sources of Waterways Information National Marine Manufacturers Association has 5 booklets which list sources for safety, cruising and local waterway information. Each covers a different region of the U.S. (North Central, South Central, Northeastern, Southeastern, and Western). For single copies write to:

NMMA
401 N. Michigan Ave.
Chicago, IL 60611

Ask for the booklet for your region.

Your Glastron owner's manual contains a wealth of information about your specific boat. Don't overlook it as an important source of safety information. In addition to your Glastron Owner's Manual, you can obtain a general purpose manual for your boat or trailer by writing to:

National Marine Manufacturers Assoc.
401 N. Michigan Ave.
Chicago, IL 60611

Ask for the booklet "You and Your Boat" or "You and Your Trailer" single copies are free.

Warranty

General

The Glastron Limited Warranty, in its entirety, appears on the inside back cover of this manual. We have made every effort to simplify our warranty so it would be easily understood. However, if you have any questions regarding the warranty please don't hesitate to contact us:

GLASTRON BOATS
700 West River Road
Little Falls, MN 56345
(612) 632-8395

The new Glastron owner must indicate an understanding of terms and conditions of the Glastron Limited Warranty by signing the warranty registration card where indicated.

The warranty registration card should be properly completed by the dealer, signed by the new owner, and returned to Glastron, Inc. within fifteen(15) days after the original purchase in order to validate the warranty. We will acknowledge receipt of your card and advise you that your warranty has been validated and is in force.

Should a problem develop with your new Glastron as a result of workmanship or materials, we want it corrected and back in service just as quickly as possible. Contact the factory authorized Glastron dealer, preferably from whom you purchased your boat. (All warranty repairs must be processed by an authorized Glastron dealer). Should the dealer fail to remedy the cause of your problem, contact Glastron, Inc. within 30 days. It is your responsibility to deliver your boat to the dealer or to Glastron, Inc., if necessary.

ALL BOATS MANUFACTURERS ARE REQUIRED BY THE FEDERAL BOAT SAFETY ACT OF 1971, TO NOTIFY FIRST TIME OWNERS IN THE EVENT A DEFECT IS DISCOVERED " WHICH CREATES A SUBSTANTIAL RISK OF PERSONAL INJURY TO THE PUBLIC." IN ORDER THAT WE CAN COMPLY WITH THE LAW, IF IT BECOMES NECESSARY, IT IS ESSENTIAL THAT YOUR WARRANTY REGISTRATION CARD WITH THE OWNERS NAME, ADDRESS, AND THE BOAT SERIAL NUMBER BE COMPLETED AND MAILED TO:

GLASTRON BOATS
700 West River Road
Little Falls, MN 56345
(612) 632-8395

Safety On Board

..

..

General Information/Safety On Board

Safety Equipment

You are required by law to provide and maintain the following safety equipment on your Glastron boat:

Personal Flotation Devices (PFDs)

All Glastron boats must be equipped with United States Coast Guard approved personal flotation devices of Type I, II, or III of a suitable size for each person aboard.

Wearable PFD Type I

Type I

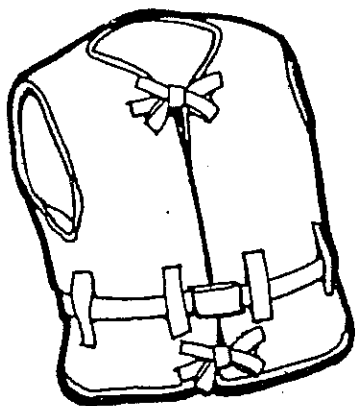

Wearable PFD Type I has the greatest required buoyancy and is designed to turn most unconscious persons in the water from a face down position to a vertical or slightly backward position. Type I is most effective for all waters, especially offshore when rescue may be delayed.

Wearable PFD Type II

Type II

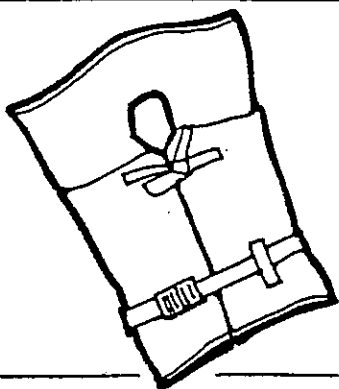

Wearable PFD Type II is designed to turn its wearer same as Type I however the turning action is not as pronounced as Type I. The Type II will not turn as many persons under the same conditions as Type I.

Wearable PFD Type III

Type III

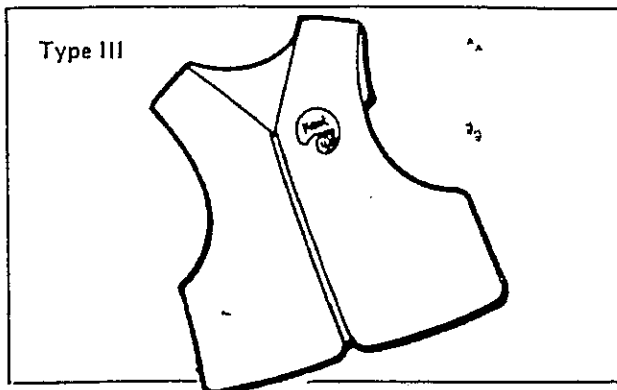

Wearable PFD Type III is designed so the wearer can place themselves in a vertical or slightly backward position. Type III has the same buoyancy as Type II PFD. But it has little or no turning ability.

PFD Type IV

Type IV

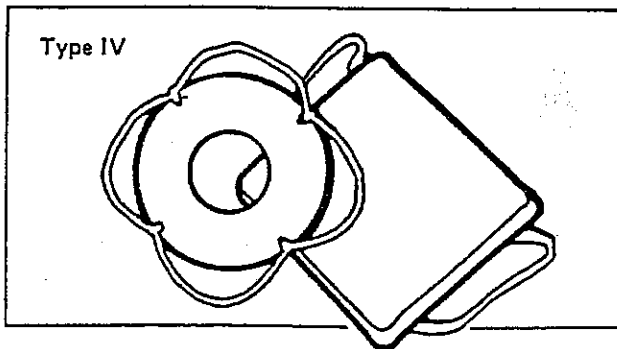

Your boat must have one throwable PFD Type IV device which can be thrown to a person in the water and grasped and held by the user until rescued. It is not designed to be worn. The most common Type IV devices are a buoyant cushion and a ring buoy.

Wearable PFD's shall be readily available and throwable devices shall be immediately available for use, and in "Serviceable Condition"

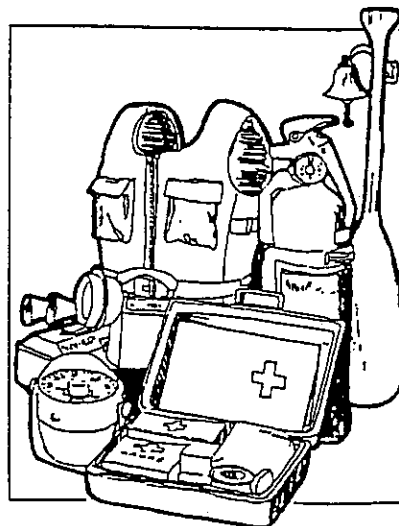

Fire Extinguishers

All class 2 boats (over 26' in length) must be equipped with at least two U.S. Coast Guard approved hand portable type B-I extinguishers or at least one B-II type approved portable fire extinguisher.

Boats under 26' in length are required to be equipped with at least one U.S.C.G. approved hand portable type B-II extinguishers.

The extinguishers should be mounted in a readily accessible location away from the engine compartment. All persons on board should know the location and operation of all fire extinguishers. When an approved fire extinguishing system is installed one less B-I type is required.

If your fire extinguisher has a gauge as an indicating device, cold or hot weather may have an effect on the gauge reading. Consult the instructions supplied with the fire extinguisher to determine the accuracy of the gauge.

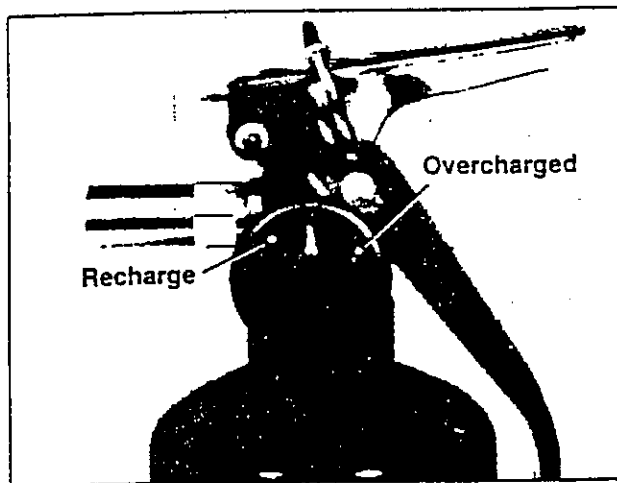

Typical Dry Chemical Extinguisher
with Charge Indicator

Horn and Bell

All class 2 boats (over 26' in length) must be equipped with a hand or power operated mechanical device capable of producing blasts of two second duration audible at a distance of at least one mile, and a bell which, when struck, produces a clear bell-like tone. This device is commonly called a "fog bell".

Boats under 26' in length are required to be equipped with an "efficient" sound producing device, which can be mouth, hand or power operated, capable of producing a blast of two second duration audible at a distance of at least one-half mile.

Visual Distress Signals

All boats operated on coastal waters and territorial seas (including the Great Lakes) in excess of two miles wide must be equipped with visual distress signals.

Pyrotechnic and non-pyrotechnic devices must be Coast Guard approved, in serviceable condition and stowed to be readily available. If dated with a date showing the serviceable life, this date must not have passed.

Pyrotechnic USCG approved visual distress signals and associated devices include:

- Pyrotechnic red flares, hand held or aerial.
- Pyrotechnic orange smoke, hand held or floating.
- Launchers for aerial red meteors or parachute flares.

Non-pyrotechnic devices:

- Orange distress flag.
- Electric distress light.

No single signaling device is ideal under all conditions and for all purposes. Consideration should therefore be given to carrying several types.

If young children are frequently aboard, careful selection and proper stowage of visual distress signals becomes especially important. If you elect to carry pyrotechnic devices, you should select those in tough packaging and not easy to ignite should the devices fall into the hands of children.

Registration

Federal and State laws require that every boat with propulsion machinery of any type be registered in the state in which it is principally used. Registration numbers and validation stickers must be displayed on the boat according to regulation and the registration certificate must be carried on board when the boat is in use. Check individual state and local laws for more regulations.

Other Recommended Equipment









- Owner's Manual, Engine Manual
- Anchor and line
- Manually operated bilge pump
- Bucket & sponge
- Compass, navigational charts
- Boat hook
- Flashlight
- Docking & towing lines
- First aid kit
- Commonly used spare parts
- Tool kit
- Fenders
- Extra keys

General Information/Safety Afloat

Weather Awareness

A good understanding of basic seamanship makes for a safe skipper. Basic seamanship covers everything from boat handling to weather. To the knowledgeable skipper, storms rarely appear without considerable advance notice. With today's vast network of meteorological observation and reporting stations around the world and the availability of weather reports by radio, you have accurate weather information faster than ever before. But when the weather bureau has a failure in their predictions, in the interest of safe boating there is no substitute for strong understanding of what action to take when the weather takes a turn for the worst. Many cruiser clubs fly weather signals. You should learn to recognize these signals, and listen to your own local forecasting before leaving port.

Chart of Storm Signals

	Daytime Flags	Nighttime Lights
Small Craft Warning Winds up to 38 mph		
Gale Winds to 54 mph		
Whole Gale Winds to 72 mph		
Hurricane Winds of 72 mph & over		

Storm Tips

- Watch horizon for approach of storm
- Turn on radio for weather information
- Return to safe port if time allows
- Stow loose gear below and lash any gear on deck
- Close ports and hatches and secure them
- As seas build slow down. Have crew and passengers on deck put on life jackets.
- Maneuver to stay well off lee shore in case of engine failure
- Use just enough power to maintain steerageway
- Most boats ride best heading into seas. Experiment
- Choose heading that is most easy riding

Fog Tips

- When fog sets in take bearings, and mark position on chart
- Keep log of courses and speeds
- Sound horn or fog bell intermittantly to warn others
- Slow down
- Station lookout forward
- Stop engines from time to time and listen for other fog signals
- Take sounding if you have equipment on board and match up with sounding on chart
- If you have any doubt, anchor and listen for other fog signals while still sounding yours
- Radar reflector — they should be (18" diagonal) 12' above water
- Have crew put on life jackets

Running Aground

If you run aground, check your passengers for injury and any damage to the boat or propeller(s). Try to shift the weight of passengers and/or gear to heel boat while reversing engine. A boat hook can be used to help push off or ask a passing boat to pass a tow line for help in pulling off. If these efforts fail, get help from the Coast Guard.

Collision

If you should have a serious collision, check your passengers for injury and check the extent of damage. Stand by to help the other craft unless your vessel or passengers are in danger. If the bow of the other vessel has penetrated your boat's hull, stand by to plug the fracture upon separation of the vessel. Shore up the hole with a spare life jacket or bunk cushions on the inside of your boat. Place duct tape or canvas patch on the outside of the hull with wood strips nailed over the hole. While plugging the hole, trim weight to get the hole out of water during repairs. If your boat is in sinking condition, get all hands in life jackets. If you have a radio notify the Coast Guard or other authorities immediately. VHF channel 16 or 22 CB radio

Fire On Board

You should be familiar with the operation of the fire extinguishers on board. If you should have a fire on board, stop the engines and work fast. If the fire occurs in the engine compartment, shut off the fuel supply immediately. Have all hands put on a life jacket. If the fire gets out of control, make a distress signal, call for help on the radio and jump overboard.

General Information/High Performance Boats

Certain Glastron boats are capable of speeds in excess of 45 m.p.h. Consult your dealer for full performance capabilities of your boat.

High performance boats should not be commanded by inexperienced persons until complete instructions in the use, and the driver check-out is completed under the supervision of a qualified person. The person in control of a high performance boat should be very mindful of the safety of others, as well as his own well-being. Passengers should be made aware of the possibility of being thrown to the deck, or even from the boat if they are not carefully seated while the boat is being run at high speeds. Do not operate your boat at high speeds in the proximity of other boats, pilings, underwater obstructions, sea walls, or other obstacles.

More frequent checks and preventative maintenance procedures are required for high performance boats. Mechanical failure at high speeds may cause very serious consequences to persons and property. Remember that the person in control of the boat is responsible for his own acts of negligence or carelessness.

Engine Shut-Off Safety Switch

The engine shut-off safety switch is standard equipment on most outboard motors. The purpose of the engine shut-off safety switch is to stop the engine when the operator leaves his control station accidentally by falling in the boat or by falling or being ejected overboard. This can happen as a result of poor operating practices such as sitting on the back of the seat at planing speeds, standing at planing speeds, operating at high speeds in shallow or obstacle laden water, drinking and driving, or engaging in daring high speed maneuvers. Since there is a tendency of an unmanned boat, powered by a motor, to circle (known as the circling phenomenon), the installation and use of an emergency stop switch may help to prevent injury to an operator who has fallen or been ejected overboard by preventing the boat from circling and hitting the person in the water.

The engine shut-off switch has one main

disadvantage; inadvertant activation of the switch. This could cause any or all of the following potentially hazardous situations:

- * Loss of balance and falling forward of the boat passengers - a particular concern on bow rider type of boats.
- * Loss of power and directional control in heavy seas, strong currents, or high winds.
- * Loss of control when docking.

WARNING

As Glastron cannot possibly know of and advise the boating public of conceivable boat/motor types and/or poor operating practices the final decision of whether to use an engine shut-off switch, rests with you the owner/driver.

FLOAT PLAN

Glastron recommends filling out a float plan each time you use your boat. Leave this information with a responsible person ashore, i.e., friend, relative, dockmaster.

If not returned by _____ call the Coast Guard or (Local Authority) Rescue Center telephone numbers (Coast Guard) _____ (Local Authority) _____ (Rescue Center) _____

1. Name of person reporting _____

Telephone No. _____

2. Description of Boat: Name of Boat _____ Type _____

Color: Hull _____ Deck _____ Cabin _____ Trim _____

Registration No. _____ Length _____ Make _____

Other _____

3. Persons Aboard: Total _____

Name _____ Age _____ Phone No. _____

Address _____

Name _____ Age _____ Phone No. _____

Address _____

Name _____ Age _____ Phone No. _____

Address _____

Name _____ Age _____ Phone No. _____

Address _____

4. Engine: Type _____ H.P. _____ Fuel _____ Gals. _____

5. Survival Equipment (Check as appropriate) _____ Life Jackets _____ Cushions _____ Flares _____ Mirror _____

_____ Smoke Signals _____ Flash Light _____ Distress Light _____ Anchor _____ Paddles _____ Food _____

_____ Water _____ Raft/Dingy _____

6. Radio Yes/No: Frequencies _____

7. Trip Expectations: Leave at _____ (time) From _____

Going to _____ or _____

Expect to Return by _____ (time) and in no event later than _____ (time) _____

8. Any other information _____

GLASTRON

Data Sheet

Model Name _____ Hull Serial Number _____
Name of Boat _____ State _____ Length _____ Beam _____
Hull Colors(s) _____ Weight _____
Draft (Engine Down) _____ (Engine Up) _____ Freeboard (Forward) _____ (Aft) _____
Engine(s)
Make _____ Model Name _____ H.P. _____ Model No. _____
Number of Engines _____ Serial No.(s) _____

Fuel Filter No. _____

Fuel Capacity _____ Number of Tanks _____

Water Capacity _____ Number of Tanks _____

Radio

Make _____ Type _____ Model No. _____ Serial No. _____

Battery Make _____ Type _____

Propeller(s) Manufacturer _____ Diameter/Pitch _____

No. of Blades _____ Style _____ Material _____ Mfg. Part No. _____

Key Numbers Cabin _____ Glove Box _____ Ignition Switch(s) _____

Generator

Make _____ Model Name _____ Model No. _____

Serial No. _____ K.W. _____

Other Equipment

Selling Dealer

Name _____

Address _____

Phone No. _____

Salesman _____

Servicing Dealer

Name _____

Address _____

Phone No. _____

Service Manager _____

Electrical System

Electrical System/12 Volts D.C. System

Description

The D.C. electrical system is a 12 Volt, 2 wire, negative ground type. The hot wire is positive, feeding the lights and appliances for instance, and the negative return is by an insulated wire to the negative terminal of the battery. Basic wiring of the individual system is independent so that trouble in one is not reflected in the others. A single 15 amp master fuse, located in the splashwell, provides circuit protection for the entire system on Glastron outboard boats.

The charging system will recharge the batteries when the engine is running.

Overload Protection

The engine is equipped with a fuse or circuit breaker to protect the engine wiring harness and instrumentation power leads. If an electrical overload occurs, the breaker or fuse will open and interrupt current flow when the current draw exceeds the rated amperage. Refer to your engine manual for location and resetting procedure.

Wiring Color Code

The most recent color coding of boat wiring is one proposed by the (American Boat and Yacht Council). It is published in the organization's Safety Standards for Small Craft manual. Glastron and boat equipment manufacturers voluntarily comply with these standards so the owner of a new boat can easily install equipment or troubleshoot the electrical system. Here is the color code system:

RED wire is used for the positive(+) side of the battery DC systems on wires that go to fuses or circuit breakers, to distribution panels and high-draw equipment(engine starters), start ignition switches to ammeters.

YELLOW WITH RED STRIPE wire is used on one circuit only; from starter switch to the starter solenoid.

DARK GRAY wire is used for navigation lights and wire between the fuse and the lights. It is also the color used for the sensor wire from the tachometer sender to the gauge.

BROWN wire is used for the leads to the bilge pumps from fuses or switches.

PURPLE wire is used from the ignition switch to electrical instruments through a distribution panel.

DARK BLUE wire is used for instrument cabin lights, and these run from switches or fuses to the lights.

Function	Gauge	Color
Negative Lead	10	Gray
Positive Lead	10	Gray/Red
Anchor Lights	14	Gray
Navigation Lights	14	Gray/Blue
Panel Lights	14	Blue
Courtesy Lights	14	Blue/White
Cabin Lights	14	Blue/Black
Bilge Pump	14	Brown
Accessory	14	Orange
Horn	14	Orange/White
Stereo	14	Purple/Red
Stereo Memory	14	Red
Ground	14	Black

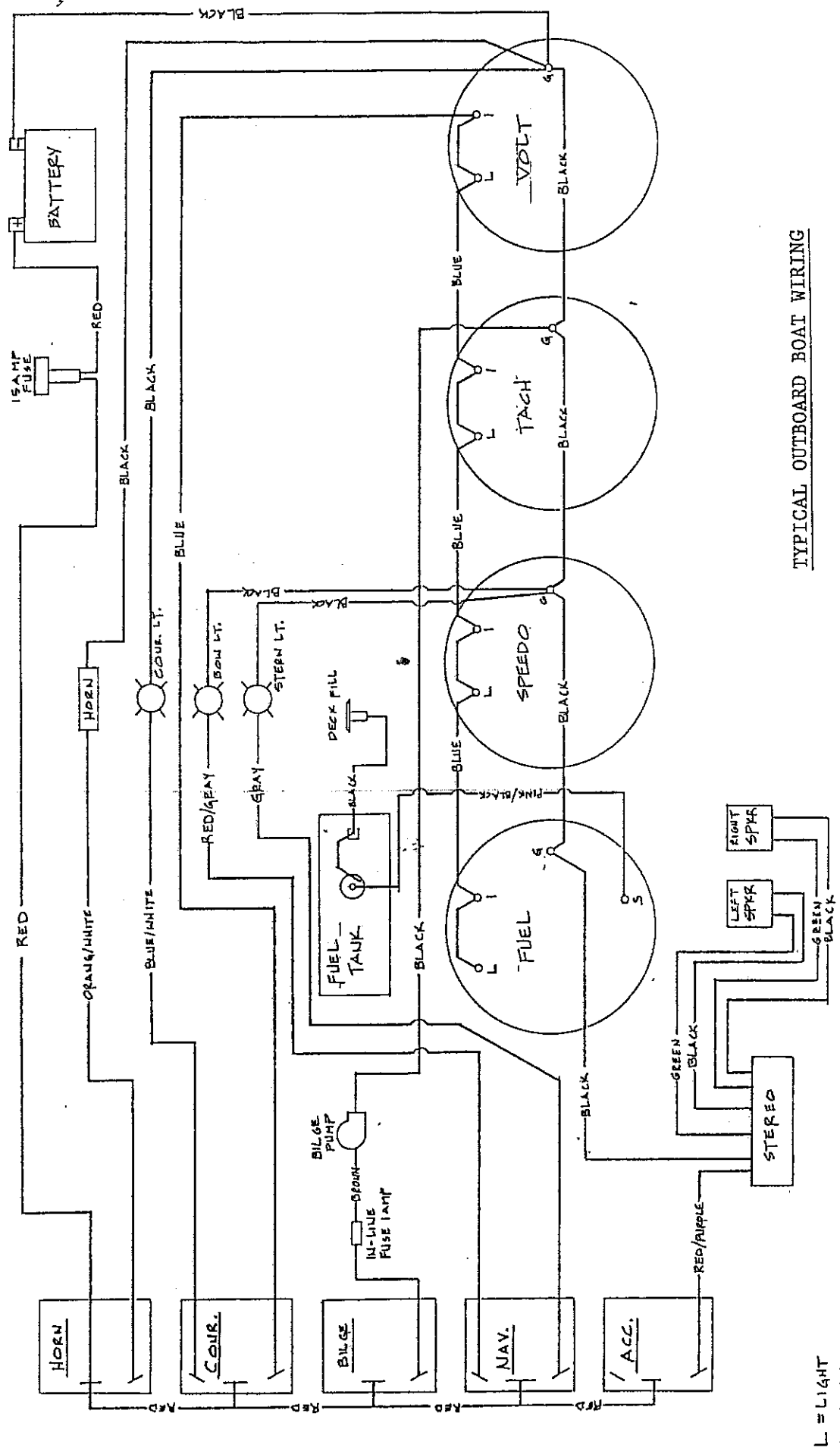

TYPICAL OUTBOARD BOAT WIRING

- L = LIGHT
- I = IGNITION
- G = GROUND
- S = SENDER

Getting Under Way

Getting Under Way/Loading

CAUTION!

Overloading and improper distribution of weight causes a significant number of accidents. Capacity plates indicate maximum loads under normal conditions. Give yourself an extra margin of safety in rough water.

When loading your boat remember to distribute the load evenly, keep the load low and do not overload.

OVERLOADING IS A VIOLATION OF COAST GUARD REGULATIONS!

The capacity plate attached to your boat states the maximum weight capacity for person and gear that the boat will handle safely under normal operating conditions. These load capacity ratings are computed from a formula determined by the U.S. Coast Guard.

Glastron capacity ratings also meet the requirements of the National Marine Manufacturers Association (NMMA).

When loading your boat always step onto the boat, never jump. Have someone on the dock pass the gear aboard. Secure all gear firmly so that it will not shift or interfere with the operation of the boat.

U.S. COAST GUARD MAXIMUM CAPACITIES

7 PERSONS OR 1015 LBS.

1550 POUNDS, PERSONS, MOTOR, GEAR
125 HORSEPOWER MOTOR

THIS BOAT COMPLIES WITH U.S. COAST GUARD SAFETY STANDARDS IN EFFECT ON THE DATE OF CERTIFICATION

MODEL 7-17

DESIGN COMPLIANCE WITH NMMA REQUIREMENTS BELOW IS VERIFIED. MFG. RESPONSIBLE FOR PRODUCTION CONTROL

LOAD & HP CAPACITY * INTL. LIGHTS
STEERING, FUEL AND ELECTRICAL SYSTEMS
VENTILATION * LEVEL FLOTATION

MANEUVERABILITY
NATIONAL MARINE MANUFACTURERS ASSN.

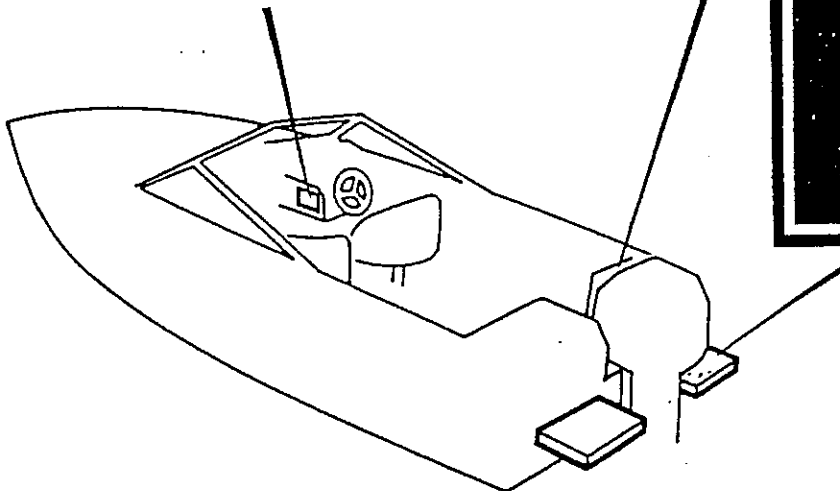

DANGER
AVOID PERSONAL INJURY
STOP ENGINES IF PERSONS
ARE NEAR PROPELLERS

DANGER
AVOID PERSONAL INJURY
KEEP AWAY
WHEN ENGINES ARE RUNNING

The capacity plate shown here is for reference only and is not necessarily the one for your boat. Capacity plates are only installed on boats under 26 feet in length.

<https://www.boat-manuals.com/>

Passengers should board your boat one at a time, have them be seated to maintain an even trim.

Do not allow passengers to ride on the bow with feet dangling over the side. Do not allow passengers to ride sitting on the stern, gunwales, or seat backs. Do not let passengers sit such that they interfere with the drivers visibility. Remember that the presence of the capacity plate does not relieve the skipper from the responsibility of using common sense or sound judgement. Rough water and adverse weather conditions will reduce the maximum capacity rating of the boat.

Fueling Procedures

WARNING FIRE AND EXPLOSION HAZARD

Fuel leakage from any part of the fuel system can lead to a fire and explosion hazard which can cause serious bodily injury or death. Careful and periodic inspection of the fuel system is mandatory, particularly after storage. All fuel components including fuel tank(whether metal or plastic), fuel lines, fittings, fuel filters, fuel pumps, and carburetors should be inspected for leakage, softening, hardening, swelling or corrosion. Any sign of leakage or deterioration requires replacement before further engine operation.

Because of the possible adverse effect of alcohol in gasoline, it is recommended that only alcohol-free gasoline be used. If only fuel containing alcohol is available, or if the presence of alcohol is unknown, then increased inspection for leaks and abnormalities is required.

NOTE

Gasoline should be poured through a fine mesh strainer(100 mesh or finer). This will help eliminate water and dirt which might otherwise clog fuel passages. Use only clean containers for mixing fresh gasoline.

Engine Break-in

The amount of time for breaking in an engine varies with the engine make and size. Refer to your engine owner's manual for automatic oil system operation or for mixing oil and gasoline for engines without automatic oiling.

Fueling Procedure

Gasoline fumes are heavier than air and will sink to the lower part of your boat such as the bilge. These areas must be periodically flushed. Every year the Coast Guard reports fires and explosions due to carelessness while fueling. Therefore, precautions must be taken while fueling to prevent fumes from collecting on board, and to be sure that any fumes dispersed while fueling are not ignited. Follow the safe fueling procedure below.

Prior to Fueling:

1. Close all doors, hatches and compartments.
2. Make sure all electrical equipment is turned off.
3. Don't smoke or allow anyone aboard to smoke while fueling.
4. Fuel in good light. Gas spills are not noticeable in the dark.
5. Shut off all engines and motors.
6. Make sure you are securely moored.
7. Do not stretch fuel hoses across the decks of other boats.
8. Make sure a fire extinguisher is available.
9. Remove fuel fill cap and insert the hose nozzle into tank opening. Hold nozzle handle securely. Nozzle must touch metal fill to avoid static produced sparks.
10. Allow a little space at the top of the tank. Do not fill completely to the opening.

After Fueling:

11. Replace fill cap and wash and wipe off any spillage around fuel fill area. Discard any rags that you used to wipe up spillage in a safe place.
12. Open all doors, hatches and compartment to air out any possible fumes. Make a sniff test, especially near the bilge and cabin sole.
13. Check all fuel lines and connections for leakage, if leakage is present, repair and clean up.
14. After all fumes are gone you may start your engine(s).

Getting Under Way/Instruments and Controls

General

Your Glastron boat may be equipped with a full set of instruments that give you indications of what is taking place within your engine. Upon delivery of your boat, make note of the reading that your gauges indicate. This will be a good reference point for the life of the engine. Fluctuations in gauge readings on occasion is not unusual. Greater changes in readings should be investigated.

Fuel Gauge

Your fuel gauge will give an indication of the amount of fuel contained within the fuel tank. There can be a slight error in the reading of the gauges. Keep in mind that the fuel gauge will usually read higher than actual when the boat is underway, it is good practice to use the "one-third rule" of fuel management. Use one-third of the fuel to go, one-third to get back and keep one-third in reserve.

Voltmeter

Voltmeter readings should be 12 to 15 volts when the engine is running 1000 RPM's or higher. This indicates that the battery is being charged. When the engine is not running and the ignition key or switch is "on" and the meter reading is still showing a high reading, this indicates your battery is fully charged. If meter readings indicate a constant low reading, you should give your charging system a complete check. This should include the battery system as well. Voltage drops after engine shut down indicate a battery problem or a very heavy load.

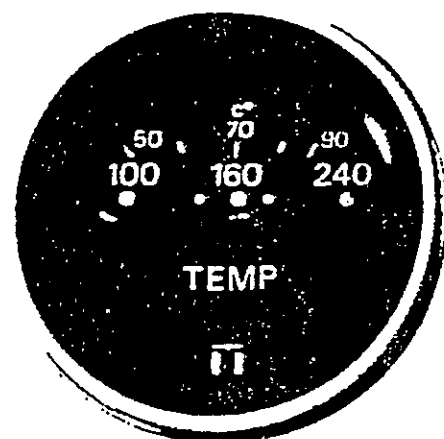
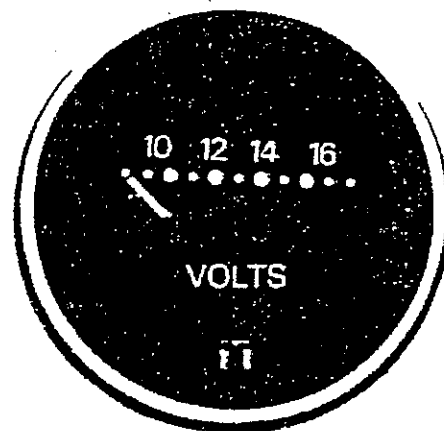
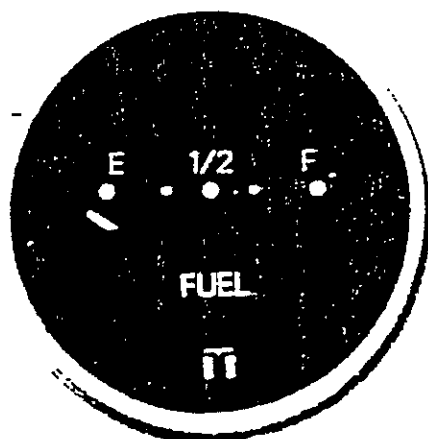

Tachometer

Indicates the revolutions per minute (RPM) your engine is running, in increments of 100. There is not a direct correlation of RPM's to speed of the the boat, due to many different factors such as wind or current.

Remote Control

Detailed explanation of the particular type of control installed in each boat and its operational function is contained in the engine manufacturer's operations and maintenance manual, or the control manufacturers manual. The throttle control regulates the speed of the engine, and also acts as the gear shift lever to control the forward and aft rotation of the propeller.

WARNING

Acceleration in reverse at too high of speeds can create a following wake that could rise above the transom and flood the boat.

CAUTION

Care should be taken when shifting between forward and reverse. To avoid drive train damage, always pause in neutral for a few seconds before reversing propeller rotation.

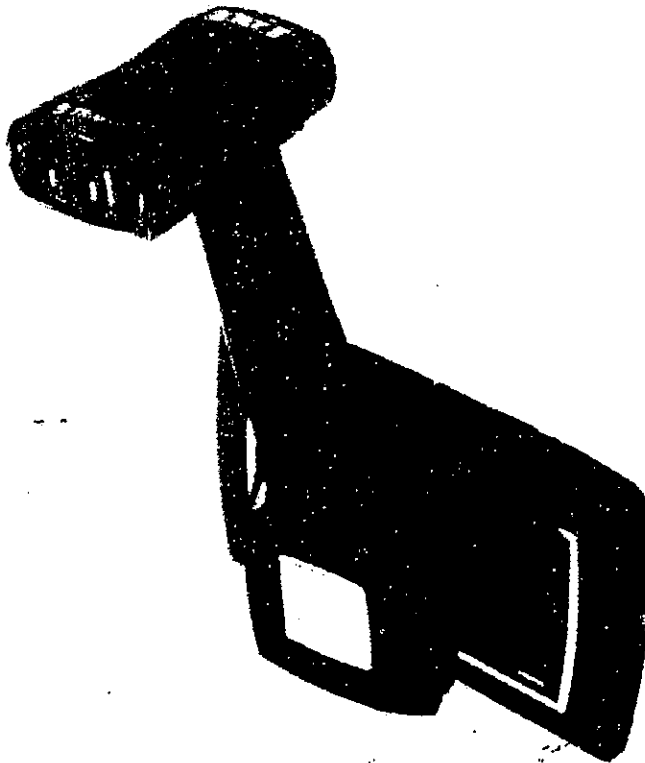

Typical Side Mount Control

Getting Under Way/Starting The Engine(s)

Pre-Start Checks

1. Your boat should be secured to the dock, trailer or mooring slip before starting the engine(s) and kept secure until the engine(s) is warmed up and running properly.
2. Put motor in normal running position.
3. Check fuel supply and open fuel valve.
4. Make a sniff test. This is a very effective way to detect fumes.
5. Attach the engine cut-off safety switch lanyard(if equipped) to the remote control and to a secure place on yourself.

Starting

1. Refer to your owner's manual for instructions peculiar to your controls (i.e. chokes, throttle position, ect.)
2. Turn ignition key clockwise to start engine. After engine starts, allow key switch to return to RUN position.

CAUTION

Do not operate starter continuously for more than 30 seconds without pausing. Allow starter to cool approximately two minutes between attempts to start your engine.

WARNING

As soon as engine starts, inspect for fuel leaks. If a leak is discovered shut down engine immediately and do not restart until leak is fixed.

CAUTION

Except in an emergency, do not shift engine operating above 1000 RPM's .

3. Inspect for fuel leaks, if a leak is discovered, shut down engine and do not restart until leak is fixed.

Getting Under Way/Accelerating

CAUTION

Full throttle acceleration for a prolonged period is not recommended until after engine break-in is completed.

After you have spent a good deal of time practicing maneuvers and have a feel for how the boat handles, you will be ready to run in open waters.

As you accelerate your boat will increase its angle of trim, causing it to ride bow-high. From a maximum angle, the boat will level out to its planing attitude with continued acceleration. This maximum angle is known as the "hump". Because visibility, handling and performance are reduced, it is advisable to get over the hump as soon as possible.

When you first begin to move, a few seconds at full throttle should get the boat into its planing attitude. Before bringing the boat on the plane, trim the engine all the way down to prevent ventilation or blow-out from too high of trim angle. An engine trimmed high will cause the propeller to ventilate or slip excessively - indicated by a quick rise in R.P.M. with no speed increase. This can be corrected by trimming down as well as retarding the throttle a little until you can feel the prop "bite" again.

Once over the hump, allow the boat to accelerate until you achieve a comfortable plane and then adjust the trim as described below.

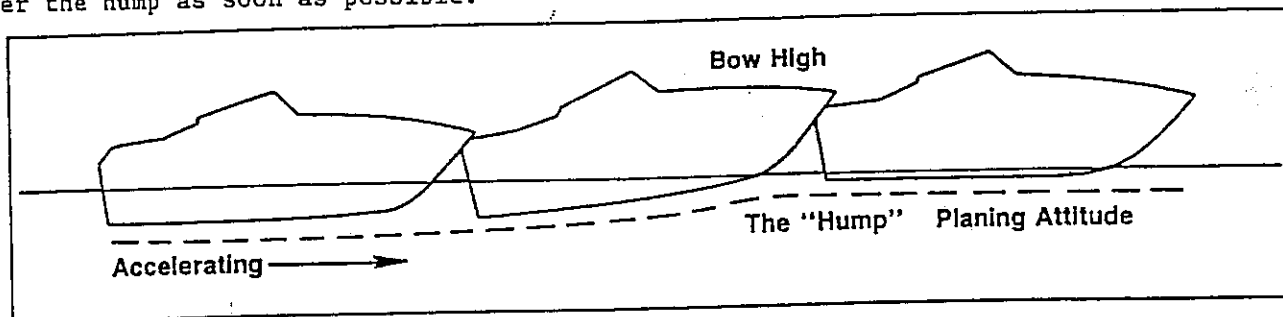

Trimming

Trimming your engine(s) while underway allows you to adjust to the ideal boat angle for a given load and water condition. Refer to your engine owner's manual for specific instructions regarding the trim controls installed on your boat, in general, the outboard has an adjustable trim range of 17 degrees (13 over and 4 under nominal running position). In some cases, the best all-around performance is obtained with the engine adjusted so the boat will run at an angle of 3 to 5 degrees to the water.

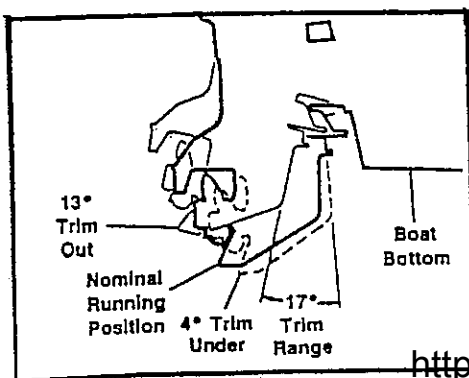
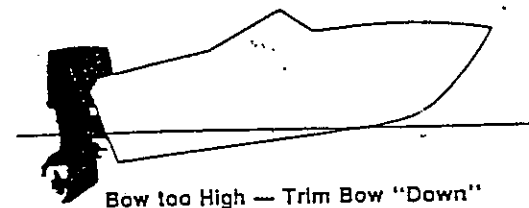
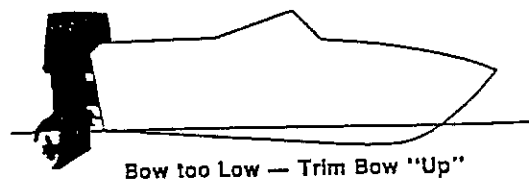
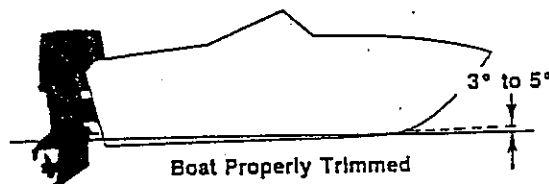

Getting Under Way/Mooring Lines

There are four types of deck lines that concern skippers of small boats. These are the bow line, stern line, and two spring lines. The first two secure the craft's bow and stern, while the spring lines keep the boat from moving forward or backward when alongside a dock. These lines have to be long enough to handle any docking situations the boat might encounter. Their length, even for a 16-foot runabout, should be at least 15 feet. Each line should have an eye splice that will fit comfortably over the bow or stern cleats. In many docking situations, particularly those of short duration, bow and stern lines will suffice when secured with a clove hitch. For longer periods and in situations where the water is running swiftly, spring lines are needed. The stern spring line leads from the stern cleat of the boat forward to the piling or cleat on the dock. The bow spring line is led from the bow cleat aft to the dock. When mooring a boat into a slip, bow and stern lines on both port and starboard sides will keep the craft in position. In tidal conditions, it is essential to leave slack in the lines for rise and fall of the water.

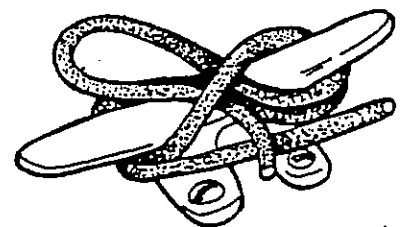
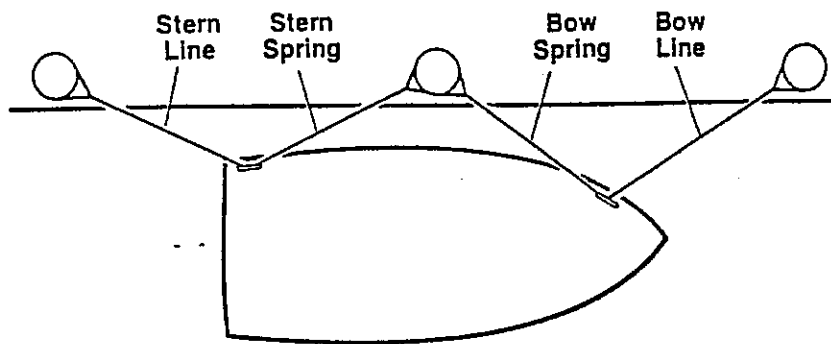
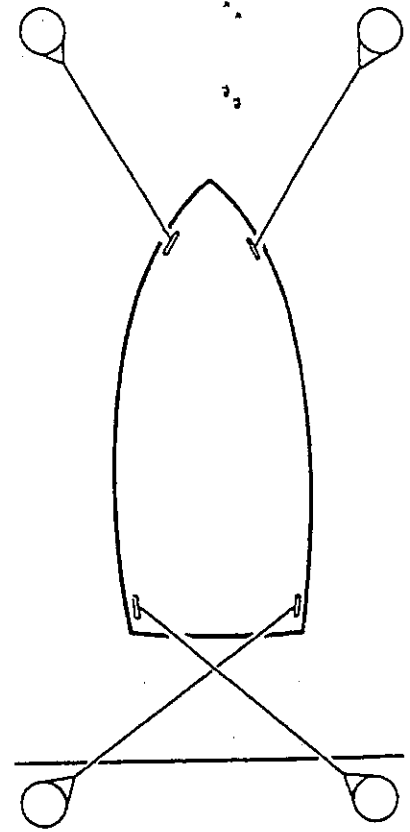

Making fast to a deck cleat

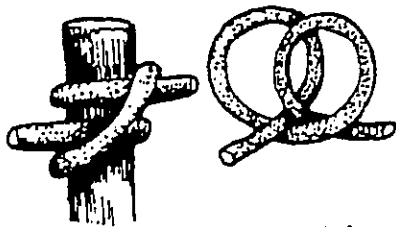

The clove hitch is used for making a line fast temporarily to a pile or bollard.

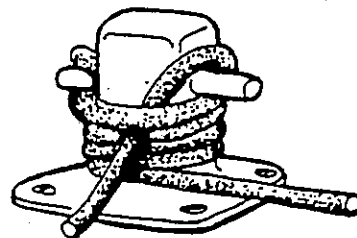

Making fast to a dock bit

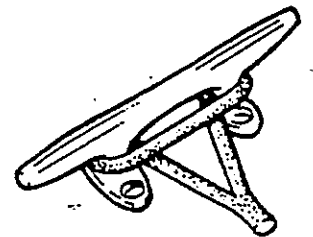

An eye spliced into the end of the line provides a convenient method of making it fast to an open cleat.

Getting Under Way/Mooring Lines

Rope Materials

Although you still see rope made from the old material of hemp or manila, it is increasingly hard to find. The new kinds of rope are so superior that the boat owner has little reason to pay any attention to most of the old materials, although he may have difficulty in making the right choice among the new forms. Nylon rope is strong (more than twice as strong as the best yacht manila of the same size) and has useful qualities of elasticity on controlled stretch. The rope can be given various degrees of softness or hardness and some variations in surface textures, to fit its intended uses. With its shock-absorbing elasticity it is particularly well-suited for dock lines and anchor lines.

There is one other characteristic of nylon rope; not only does it stretch, it can shrink - 10% or more - under some circumstances. But unlike manila, it does not shrink with each wetting. High-tenacity polyester fiber (Dacron, Terylene, Duron, Fortrel, A.C.E. and

Kodel are trademarks) is made into rope that is virtually as strong as nylon but has one important difference: the rope can be made to have very little stretch. In manufacturing, polyester rope can be given varied finishes: woolly, smooth, or textured to make it easy to grip, as required.

Aramid fiber (Kevlar), the newest material used for marine rope, combines strength and string dimensional stability (near zero stretch). It is comparatively expensive.

Polypropylene rope is the least expensive among the synthetics; it is about as strong as manila, but tends to deteriorate rapidly from exposure to the ultra-violet component of sunlight. Its main advantage is that it floats, so it is very well suited to water-ski tow ropes. Any other use aboard a boat is an economy measure and may be unwise. For appropriate special purposes it should be large size (compared to nylon) and replaced frequently.

Getting Under Way/Water Skiing

Some Glastron models are more suited for water skiing than others. The larger models for example produce unusually large wakes. This may be excellent for trick skiers, but a serious problem for the novice. Large wakes are also undesirable in slalom skiing and double-wake cut jumping. If your boat is not equipped with a ski-tow eye, consult your Glastron dealer. Your dealer can also assist you in the full line of ski accessories.

The ski-tow hardware which is installed on most Glastron models is designed strictly for towing water skiers, No more than two skiers should be towed at once. The fittings are specifically not intended for towing parasailers or other boats. With your Glastron appropriately equipped you can start driving for water skiers. If you have never driven water skiers before, it's a good idea to spend some time as an observer, working with and learning from an experienced driver. However, even an experienced driver should be familiar with the boat and the way it handles before pulling a skier.

The driver should also know the skiers past experience and drive according to their ability.

The popular sport of water skiing has brought a special set of safety precautions to observe in boating. The following guides will do much to reduce the hazards while water skiing. Check for local regulations.

1. Water ski only in safe areas, away from other boats and swimmers, out of channels, and water free of underwater obstructions.
2. Individuals who cannot swim should not ski.
3. Be sure that the skier is wearing a proper lifesaving device. A properly designed ski vest is intended to keep a stunned or unconscious person afloat.
4. Always carry a second person on board to observe the skier so that the full attention of the driver may be given to the operation of the boat and the waters ahead.
5. Approach a skier in the water from the lee side (down-wind), and be certain to stop your motor before coming in close proximity to the skier. We generally recommend to approach on the drivers side so you never lose sight of the skier in the water. **WARNING:** A rotating propeller can fatally injure someone in the water. Always watch for swimmers or skiers, and steer well clear. When picking up a skier or swimmer, stop the boat before the propeller is near the person then shut off the engine until the person is safely aboard.
6. Give immediate attention to a fallen skier. Be careful not to swamp the boat while taking the skier aboard.

Below is a set of hand signals recommended by the American Water Skiing Association. skier, observer and the boat operator should all know and understand these 10 simple signals.

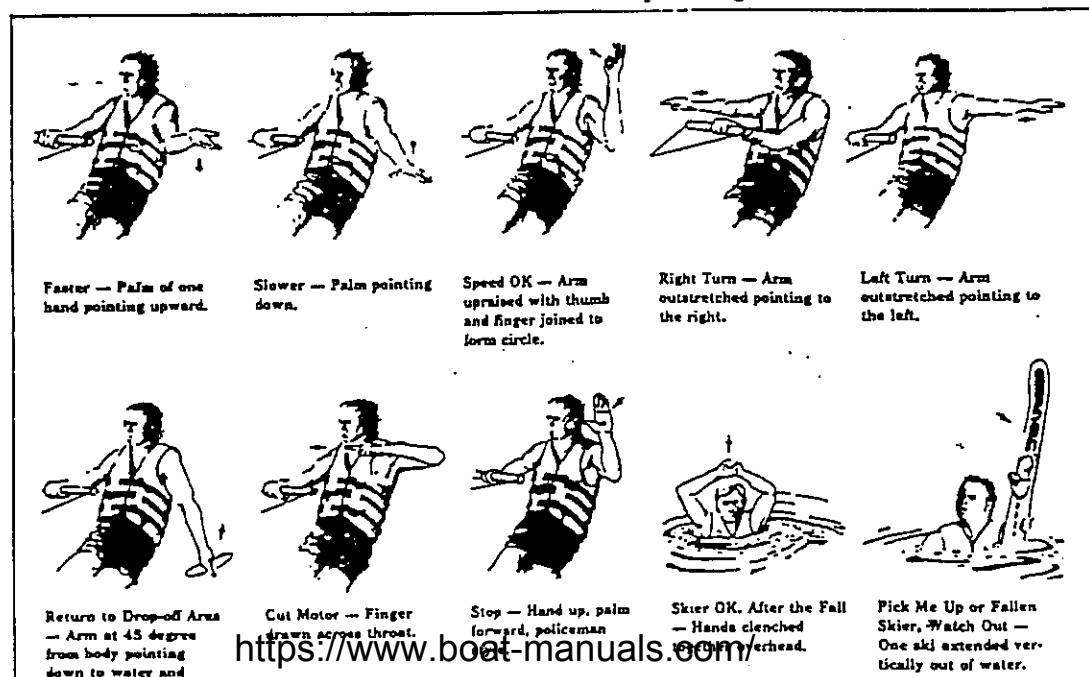

Preventive Maintenance/Engine(s)

General

You have been supplied with an engine manual that pertains to the outboard installed on your boat. For detailed information please consult the engine manufacturer's instructions. Glastron recommends that you have your boat serviced at an authorized Glastron dealer. Refer to your outboard motor owner's manual or authorized service center for maintenance of outboard motor components and propellers. However, you can perform the following preventive maintenance tasks if you are so inclined.

Fuel System

General

The fuel system in your Glastron is designed to provide the aspect of safety in the prevention of fire and explosion and to provide a continuous flow of clean fuel to your engine. The system is designed and built to conform to, or exceed all standards set by the U.S. Coast Guard and N.M.M.A.

It is most important that you check your fuel system at frequent intervals. The entire system must be kept liquid and vapor tight within the hull interior. A half tea cup of gasoline can create enough explosive vapor to totally destroy a large boat.

The fuel tank installed in your Glastron is baffled aluminum or plastic and is securely fastened in its location. Inspection plates or hatches are located over the fitting on top of the tank when under the cockpit sole.

An anti-syphon valve is located in the line at the pick-up fitting on the aft section of the tank.

Inspection

The following checks should be performed on a monthly basis:

1. Check entire fuel system for leaks, starting at fuel tank.
2. Check fuel lines and hoses for cracks or other signs of deterioration. If replacement is necessary, see your Glastron dealer.
3. Check fuel line fittings, carburetor and mounting fasteners for tightness.
4. Check condition of ventilation hose and clamps. If replacement is necessary, see your Glastron dealer.
5. Check fuel tank vent on outside of hull for obstruction.

Steering Cable Lubrication

The steering cable ram was greased when the outboard was installed by your dealer. Once the boat is put into use, periodic regreasing is required (every 60 days for fresh water; every 30 days for salt water). Use the type of grease specified by the engine maker or dealer.

CAUTION

Failure to regrease as recommended could result in steering system corrosion which could affect steering effort making operator control difficult.

Steering System

The standard steering for Glastron outboard boats is a mechanical system utilizing an enclosed push-pull cable.

Some outboard boats have dual steering cables.

All steering systems require periodic maintenance to be trouble free and safe. Regular checks of the complete system, whichever system you may have, is essential. Push-pull cable steering should be checked for proper lubrication of the cable, proper alignment, with no binding or looseness and no interference in the system.

Cable and attachments to the engine should be checked for wear, rust, or corrosion, and be properly lubricated.

Glastron recommends that all repairs and/or replacement to steering systems be made only by qualified dealers certified by the manufacturer of the steering system on your boat.

CAUTION

Boat steering is not self-centering. Steering is affected by engine and propeller torque, trim tab setting, engine trim, wave and current action, and the speed of the hull through the water. Constant attention and control of the direction of the boat is required for safe operation.

Preventive Maintenance/Bilge

Inspection

The deep parts of the hull beneath the cockpit floor are the bilges. The water from the bilges flows through limber holes in the bulkheads and stringers to the deep part of the bilge. The bilge should be checked before getting underway to make sure it is free of water.

It is normal to have a slight bit of water in the bilge. Should your bilge become filled with oil or fuel, check for leaks and correct immediately. If your boat is in the water do not pump oil or fuel overboard.

Cleaning

Pump bilges dry and remove all loose dirt. Be sure all limber holes are open and the bilge pump strainers are clean. Oil stains are best removed by use of a bilge cleaner available from your dealer or a marina. **DO NOT USE FLAMMABLE SOLVENTS TO CLEAN YOUR BILGE.**

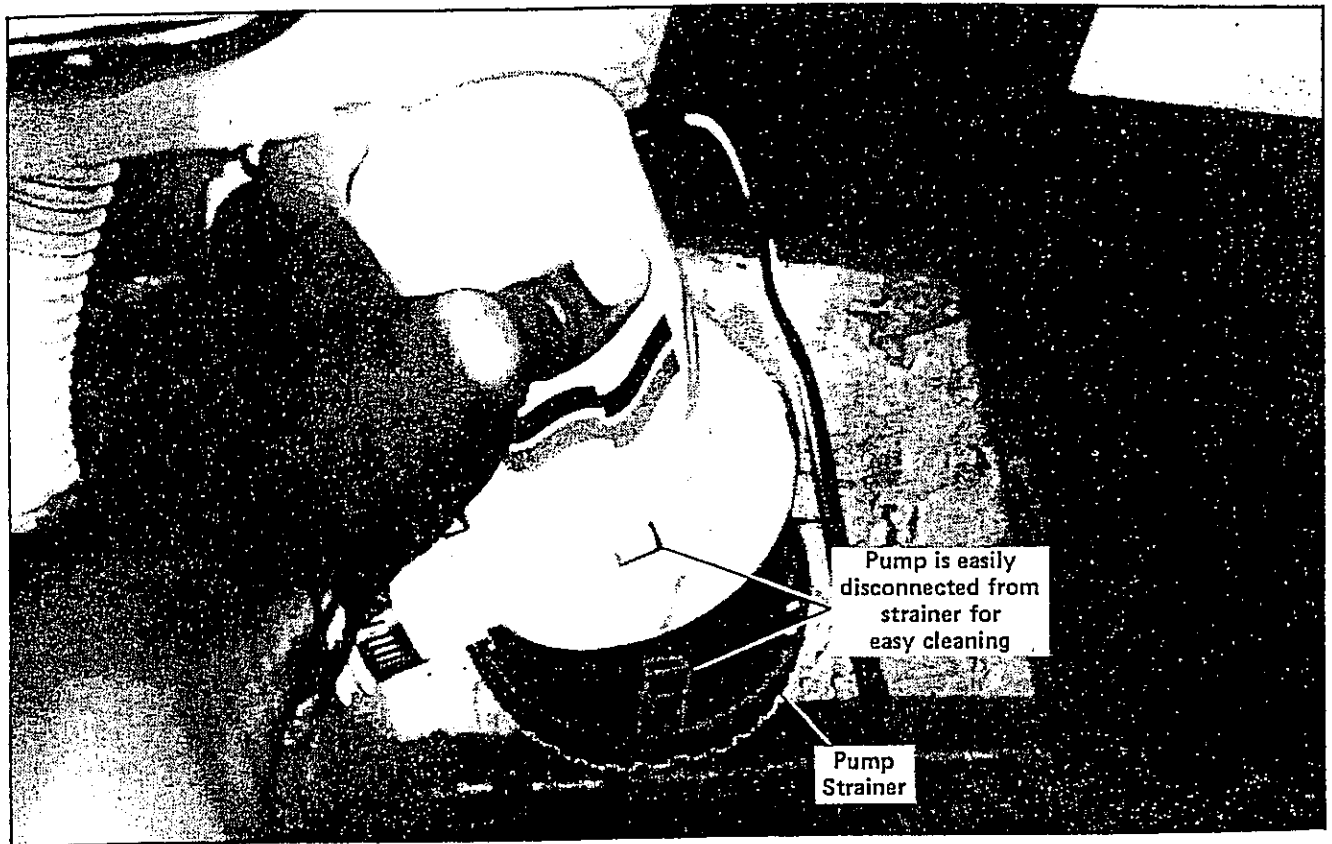

Typical Electrical Bilge Pump
(Shown Removed from Base Strainer)

NOTE

The Federal Water Pollution Control Act prohibits the discharge of oil or oily waste into or upon the navigational waters of the United States or the water of the contiguous zone if such discharge causes a film or sheen upon, or discoloration of the surface of the water, or causes a sludge or emulsion beneath the surface of the water. Violators will be subject to a penalty of <https://www.boat-manuals.com/>

CAUTION

Electrically operated bilge pumps are subject to malfunction and are no substitute for frequent inspection of the bilge, especially during periods of long rain, high seas, or storm conditions.

Troubleshooting/Engine Problems

This chart is designed to aid you in finding and correcting minor engine problems. If the problem is too complex, we suggest you contact your local authorized dealer.

Troubleshooting is a logical sequence of elimination. First, decide what the problem is, then start the process of elimination starting with the simpler causes and working toward the more complex.

Before attempting any checks or repairs around engine or electrical components, disconnect battery cables to avoid the possible personal injury or damage to the equipment.

Problem	Probable Cause	Remedy
Engine will not start (fuel system)	Improper starting procedure Empty fuel tank Choke not operating properly Clogged fuel filters Faulty fuel pump Engine flooded Contaminated fuel	Review starting procedure. Check fuel tank for fuel level. Check choke linkage for binding or an obstruction. Check wiring to solenoid. Check and replace filters. Refer to engine manual for fuel pump testing. Do not attempt to start engine for at least 5 minutes then fully advance throttle, (make sure remote control is in neutral position) and crank engine. Inspect fuel for water or other contaminants. If contaminated, drain tank and flush with fresh fuel.
Engine will not start (Ignition system)	Ignition switch defective Ignition interrupt switch disconnected. Spark plugs fouled or broken	Inspect switch for loose connections, test switch continually Replace switch if necessary. Reconnect lanyard fitting. Clean, regap or replace.

Problem	Probable Cause	Remedy
Misfiring	Fouled spark plugs Wet spark plug wires	Remove, clean or replace. Wipe dry, inspect and replace damaged wires.
Low cranking speed	Loose or dirty electrical connections or damaged wiring Bad battery	Check all associated electrical connections and wires. Test battery as explained in electrical section under batteries in engine manual.
Starter will not crank engine	Discharged battery Corroded battery terminals Loose connection in starting circuit. Defective starting switch Starter motor brushes dirty Jammed "starter drive"	Charge battery or change battery. Clean terminals. Check and tighten all connections. Replace switch. Clean or replace brushes. Loosen starter motor and free gear.
Starter motor turns but does not crank engine	Partially discharged battery Defective wiring Broken "starter drive"	Charge or replace batteries. Inspect all wiring. Remove starter motor and repair drive.

Problem	Probable Cause	Remedy
Lack of power	<p>Throttle not fully open</p> <p>Ignition or carburation</p> <p>Engine overheating</p> <p>Loose ignition wires</p> <p>Cold engine with improperly set choke</p> <p>Defective fuel pump</p> <p>Partially clogged fuel filter</p> <p>Incorrect carburetor mixture</p> <p>Contaminated fuel</p>	<p>Inspect cable and linkage for binding, obstructions, or loose fasteners.</p> <p>Service ignition system and carburetor.</p> <p>Check engine temperature. Consult engine owner's manual for proper engine operating temperature.</p> <p>Inspect all wire connections</p> <p>Check engine owner's manual for proper choke setting.</p> <p>Repair or replace.</p> <p>Clean or replace fuel filter.</p> <p>See engine's owner's manual for proper carburetor adjustments.</p> <p>Drain fuel tank and flush clean and replace fuel filters.</p>
Erratic running	<p>Choke not operating</p> <p>Faulty fuel pump</p> <p>Idle speed too low</p> <p>Faulty ignition system components</p> <p>Clogged fuel filters</p> <p>Contaminated fuel</p> <p>Kinked or clogged fuel lines or fuel tank vent line</p>	<p>Check choke linkage for binding or an obstruction. Check wiring to solenoid.</p> <p>Refer to engine owner's manual for fuel pump testing procedures.</p> <p>Check idle speed and adjust.</p> <p>Service ignition system.</p> <p>Replace filters.</p> <p>Inspect fuel for water or other contaminants. If contaminated, drain tank and flush with fresh fuel.</p> <p>Replace line if kinked, blow out with compressed air to remove obstruction.</p>
Excessive fuel consumption	<p>Restriction in air cleaner</p> <p>Faulty fuel pump</p> <p>Incorrect timing</p>	<p>Remove air cleaner and replace filters.</p> <p>Repair or replace.</p> <p>Check engine owner's manual for correct timing.</p>

Lack of Performance

Probable Cause	Remedy
Damaged or improper propeller Excessive bilge water Boat overload or load improperly distributed. Boat bottom fouled or damaged	Inspect propeller and replace if necessary. Pump out bilge and check for cause of water entry. Reduce load or redistribute load more evenly. Inspect, clean or repair as necessary.

Vibration Problems

Probable Cause	Remedy
Loose engine mounting bolts Propeller shaft bent Propeller bent or pitch out of true	Inspect and tighten bolt if necessary. Replace bent shaft. Inspect propeller and replace if necessary.

Winter Lay-Up or Storage

Winter Lay-Up or Storage/Dry Storage

Hull Preparation

If your boat is going to be placed in dry storage, as soon as the boat is removed from the water, scrub the hull and deck thoroughly to remove marine growth, scum and loose paint. The hull is easiest to clean when first removed from the water because the adhering material is still wet. If the barnacles and the other growth are on the hull it will be necessary to scrape them off.

Inspect the underwater engine components for any signs of excessive wear and examine the propellers for damage

Deck Preparation

Wash the deck, superstructure, and/or cockpit, clean chrome and coat with a rust inhibitor before storage.

Engines

The off season storage of your outboard motor is important to ensure long life and trouble free operation. Temperature and humidity changes while in storage can cause corrosion of piston rings, cylinder walls and bearing surfaces that are not properly protected. It is to your advantage to protect your motor as soon as possible upon storage. We recommend that your dealer prepare your motor for off season storage. The fuel system requires periodic cleaning and adjustment to maintain top performance. This is also the best time to have your dealer perform an engine tune-up. If you would rather prepare your own engine for storage, purchase a can of fuel conditioner and a spray can of engine fogging oil, and proceed as follows.

1. Remove engine cover. See your engine manual for direction.
2. Use of the fuel conditioner in your fuel mixture will stabilize the gasoline. It eliminates the need for draining fuel for up to one year of storage. Refer to directions on container for mixing instructions. After conditioner has been added to fuel operate in fresh water for a few minutes to allow fuel mixture to enter carburetor.

CAUTION

Do not operate your outboard motor out of water even momentarily. Doing so can result in water pump damage or motor overheating.

3. While the engine is running, spray the fogging oil into air intakes until motor smokes excessively. Stop motor. Remove spark plugs and spray fogging oil into spark plug holes. Turn engine through a number of revolutions. This will lubricate and protect the internal part of the powerhead while motor is in storage.
4. Slowly crank motor several times to drain water from the water pump.
5. Drain and refill gearcase. See instructions in the preventative maintenance section of the Outboard Owner's Manual.

Inter Lay-Up and Storage/General Housekeeping

Preventing Mildew

Remove all cushions, curtains, mattresses, lines, blankets, towels, clothing and other items that can hold moisture and cause mildew.

Mattresses and cushions may be left aboard but should be propped up to allow plenty of air circulation. The cabin, if possible, should be well ventilated. Life jackets and other such equipment left on board should be hung out in the open for maximum air circulation.

The bilge should be clean, dry and free of any materials such as rags, sponges or other cleaning material.

When a boat is covered for storage be sure to allow for ventilation either by a "breathable fabric" or open vents on non-porous material. Ensure cover is supported so water and/or snow will not pocket.

Cleaning

Scrub the inside of your boat including all cupboards, cabinets and drawers. Open your boat up to give it one last good airing out if time permits. Clean out the ice box or refrigerator. The better you leave your boat when putting it up, the easier it will be to dewinterize and commission.

Batteries

Removal

Castrol recommends that the batteries be removed during long storage periods. When removing batteries extreme caution should be exercised to avoid contact with battery acid. If spillage occurs wash area down with a solution of baking soda and water. After removing batteries, clean outside of case with baking soda/water solution.

Cleaning

Inspect batteries to make sure the battery cases are in good condition and not damaged. Terminals should be cleaned with the baking soda solution, making sure no solution is allowed to enter the cells. Clean the battery cable clamp with the same solution and brighten the post and clamp with a piece of fine grit emery cloth. Then cover the cable end with a light coat of petroleum jelly.

Maintenance

Check battery cells for fluid level. If low, add distilled water. Before storing check the specific gravity of each cell. Battery should be fully charged before storing.

Storage

Batteries should be stored in a cool dry place. Never store on concrete or dirt floor as the charge will be absorbed into the ground. It is best to place batteries on wooden racks or shelves. A monthly re-charge of the batteries is recommended.

Appearance Care/Fiberglass/Gelcoat

Description

All Glastron boats are constructed of fiberglass. The hull and deck are built separately and later assembled together. These parts are built in layers of fiberglass strands, mat, woven roving and fab mat, which are bonded together with polyester resins. The outermost layer of the hull and deck is pigmented polyester resins, called gelcoat. Gelcoat is highly resistant to scratches from scrapes which occur during normal boat use.

Maintenance

Routine cleaning with ordinary soap and water is sufficient to remove salt, dirt, and grime. Stubborn stains will require use of a special fiberglass cleaner and stain remover. The use of ammoniated or abrasive type cleaners will dull and discolor the surface of the gelcoat. Frequent waxing of the gel-coat surface will discourage soiling and help to preserve its surface lustre.

Auto wax, which is commonly used by boat owners, is formulated for acrylic or alkyd auto finishes and is therefore less effective on gelcoat. Use a fiberglass wax which will fill in the pores of the gelcoat. Also, fiberglass wax contains chemicals to screen out harmful ultraviolet rays that cause color fade.

WARNING!

Do not wax the upper deck surfaces where sure footing is required. Waxed gelcoat is very slippery, wet or dry and would be hazardous to walk on.

Repairing Gelcoat Damage

The gelcoat on your boat is approximately 1/64" thick. Minor scratches in the gelcoat itself can be wetsanded out. But keep in mind that the scratch is really not being removed; it's the removal of the gelcoat surrounding the scratch that makes the scratch seem to disappear. Be sure to keep the gelcoat protected with a coat of wax to avoid frequent sanding. Deep scratches that penetrate the gelcoat layer along with nicks, scars and small breaks should be repaired as soon as possible to avoid further damage.

Damage beyond the gelcoat layer which requires repair of the underlying fiberglass should be performed by a qualified repair person. Please consult your Glastron dealer.

Minor scratches in the gelcoat can be removed by wetsanding with a series of silicon carbide wet/dry sandpaper. Start first with 320 grit, sanding it lightly until scratches start to disappear. Use 400 grit until the scratches are gone and then finish sanding with 600 grit. Finally, buff the sanded area with rubbing compound. Use a clean dry cloth and rub hard until the compound begins to dry and then lighten up to polish the surface. Be very careful when removing scratches, with too much sanding, the gelcoat could be removed and require painting the repaired area over with gelcoat.

Anti-Fouling Bottom Paint

The bottom of your boat has the same gelcoat finish as the topsides. If foul waters produce unsightly marine growth, you may want to see your dealer regarding an anti-fouling bottom paint.

Before selecting a bottom paint, consult your dealer or boaters in your area to determine what works best for them. There are so many crucial variables involved water temperature, water pollution, salinity, sunlight, current, suspended diet and organic matter, and chemical discharges into the water, that it is impossible to select a bottom paint on the basis of advertising alone.

Appearance Care/Teak

Description

Some Glastrons have teak in their interiors. When properly maintained, teak affords a natural wood grain beauty that far surpasses any other wood used on boats. The exposure that the wood is subjected to opens the pores to the entry of ultra-violet sun rays, and salt water or fresh water. This causes the wood to expand, contract, and then oxidize.

Oxidation produces minute splitting of the grain which accelerates the aging process. Aging turns the color of the teak to a light gray. Cleaning and oiling of the teak will maintain its original appearance.

Cleaning

Use an organic cleaner that can penetrate the pores of the teak and cleanse them of dirt and stains. Avoid some of the harsh

teak cleaning liquids. Some are so caustic that they remove the soft part of the teak from the hard wood to produce a rippled surface.

Oiling

An oil sealer should be applied with a soft cloth. Excess oil should be wiped off. After the oil base has been absorbed into the wood, a second coat should be applied. During the summer, it may be necessary to reapply oil which has been lost by the drying effect of the sun. Avoid applying too many coats as this can produce a noticeable varnished look.

Deck Hardware and Fitting

Cleaning

Your hardware is plated, anodized or constructed of marine grade stainless steel. Rinse salt spray and minerals from surface after each use. Weekly (daily if used in salt or corrosive areas) coat all hardware with a fine surface treatment such as WD40 or equivalent. If corrosion or surface stains should appear, use a marine rust/stain remover, then coat with WD40 or equivalent.

Inspection

Periodic inspection of your Glastron for tightness and fit of screws, bolts, clamps and fittings is recommended. Keep sufficient tools available to adjust your boat's hardware whenever it becomes necessary.

Windshield and Ports

Windshields may be cleaned with soap and water or any good commercial glass cleaner. Plexiglass, clear vinyl and other synthetic materials should be washed with a mild soap and plenty of water, then use a plexiglass cleaner to avoid scratches. Plexiglass may be waxed after cleaning.

Headliner/Wall Covering/Cabin Upholstery

Clean soil and stains as soon as possible with a good grade automotive velour cleaner (follow instructions on container).

Appearance Care/Carpeting

Spots and Stains

Spills and stains should be treated immediately. The longer a spot remains, the more difficult it will be to remove. Blot up soils with clean, white, absorbant materials (towels, napkins, tissue, etc.). Remove solid built-up materials with a rounded tablespoon, spatula, or edge of a dull knife.

Pretest spot removal agents in an inconspicuous area. Apply several drops of solution on the carpet and rub gently with a 'clean white towel. If color transfers to the cloth or a color change occurs, a professional cleaner should be consulted.

Do not overwet. Use small amounts of the cleaning agents and blot frequently. Always blot, do not rub or brush. Work from the outer edge of the spot towards the center to prevent rings. Beginning with step 1, treat the stained area with each spotting solution until the stain is removed. It may not be necessary to complete the entire series of steps. The final step is always to gently rinse the area with water, then absorb all the remaining moisture with absorbant towels.

Be patient. Some stains respond slowly. All spots and stains cannot be removed from every fabric due to differences in fibers, dyes, constructions, finishes, composition of the stain, length of time the stain has remained on the article, etc. Some stains require professional treatment.

Cleaning Solutions

Ammonia Solution- Mix one tablespoon of clear household ammonia with one-half cup of water.

Detergent Solution- Mix one tablespoon of a colorless, mild detergent or dishwashing liquid in a cup of lukewarm water.

Drycleaning Solvent- Volatile dry spotter or commercial spotter such as Carbona, Energine, or K2R. Use in small amounts; can be harmful to sizings, backings or stuffing materials. DO NOT use gasoline, lighter fluid or carbon tetrachloride.

Enzyme Detergent- Mix a solution of enzyme detergent following the directions on the label. DO NOT soak or overwet. Allow the solution to remain on the stain for the recommended length of time before removing.

POG- Paint, oil and grease remover, available in hardware stores.

Vinegar Solution- Mix one-third cup of white household vinegar with two-thirds cup of water.

Stain	Description	Cleaning Instructions
Blood	Red when fresh, dries to dark brown with irregular edge.	<ol style="list-style-type: none"> 1. Apply cool detergent solution, blot. 2. Apply cool ammonia solution, blot. 3. Apply enzyme detergent, blot. 4. Rinse thoroughly with water, blot until dry. 5. If stain remains, apply rust remover or oxalic acid solution. 6. Bleaching with 3-5% hydrogen peroxide may be necessary.
Butter & Margarine	Greasy, yellowish-red • Contains vegetable dye, corn oil, milk, salt, preservatives, vegetable fats.	<ol style="list-style-type: none"> 1. Apply dry cleaning solvent, blot. 2. Apply detergent solution, blot until dry. 3. Apply vinegar solution, blot. 4. Rinse with water, blot until dry.
Catsup & Tomato Sauce	Reddish-brown, absorbed and built-up • Contains tomatoes, salt, sugar, spices, lannin, vinegar.	<ol style="list-style-type: none"> 1. Apply cool detergent solution, blot. 2. Apply ammonia solution, blot. 3. Apply enzyme detergent, blot. 4. If stain remains, bleach with 3-5% hydrogen peroxide or sodium perborate. 5. Rinse thoroughly with water, blot until dry.
Jam & Jelly	Reddish or bluish, absorbed and built-up • Contains pulp of fruit, sugar, lannin preservatives.	<ol style="list-style-type: none"> 1. Apply detergent solution, blot. 2. Apply vinegar solution, blot. 3. Rinse with water, blot. 4. Apply enzyme detergent, blot. 5. Rinse with water, blot until dry.

Lipstick	Various colors, soft and greasy • Contains pigment or dye in fat, waxes and oils.	<ol style="list-style-type: none"> 1. Scrape off excess with spatula or dull knife. 2. Apply POG, blot, making sure not to reapply stain onto fabric. 3. Apply drycleaning solvent, blot. 4. Apply detergent, blot. 5. Apply ammonia solution, blot. 6. Apply vinegar solution, blot. 7. Rinse with water, blot until dry. *Try to avoid wetcleaning on wool. Use POG and drycleaning solvents as long as possible.
Mildew	Grayish or brownish fungus with black spots. May permanently damage fibers.	<ol style="list-style-type: none"> 1. Apply enzyme detergent, blot. 2. Apply ammonia solution, blot. 3. Rinse thoroughly with water, blot. 4. Apply solution of oxidizing bleach (chlorine or perborate) *Do not use chlorine bleach on wool or silk. 5. Rinse thoroughly with water, blot until dry.
Mud	Grayish, brownish, reddish absorbed and built-up • Contains soil with greases and oils, clay, iron.	<ol style="list-style-type: none"> 1. Brush or scrape off as much as possible. 2. Apply detergent solution, blot. 3. Apply ammonia solution, blot. 4. Rinse thoroughly with water, blot until dry. 5. If stain remains, apply POG and drycleaning solvent alternately, blot until dry.
Mustard	Yellowish, absorbed or built-up • Contains mustard seed, vinegar, salt, turmeric, oils, spices.	<ol style="list-style-type: none"> 1. Apply detergent solution, blot. 2. Apply vinegar solution, blot. 3. Apply enzyme detergent, blot. 4. If stain remains, rust remover (oxalic acid solution) or bleaching may be necessary. *Do not use ammonia or alkalis.
Nail Polish	Various colors, stiff, shiny and built-up • Contains dye or pigment in a liquid cellulose acetate base, solvent, plasticizer.	<ol style="list-style-type: none"> 1. Apply drycleaning solvent. 2. Apply POG, blot. 3. Apply amyl acetate if available, or nail polish remover—PRETEST FIRST. 4. If stain remains, apply detergent solution, blot until dry. 5. Apply ammonia solution, blot. 6. Apply vinegar solution, blot. 7. Rinse with water, blot until dry.
Urine	Yellowish or brownish, darkened with age, absorbed • Contains urea, uric acid, ammonia, organic acids, cholesterol, albumins, proteoses.	<ol style="list-style-type: none"> 1. Blot up as much as possible if still wet. 2. Apply detergent solution, blot. 3. Apply ammonia solution, blot. 4. Apply vinegar solution, blot. 5. Rinse thoroughly with water, blot until dry. 6. If stain remains, apply rust remover or oxalic acid solution. 7. Bleaching with 3-5% hydrogen peroxide or sodium perborate might be necessary. *Urine stains may cause permanent dye removal from fibers.
Vomit	Various colors, absorbed and built-up • Contains food mucus, albumins, acids.	<ol style="list-style-type: none"> 1. Blot up as much as possible. 2. Apply enzyme detergent, blot. 3. Apply ammonia solution, blot. 4. Apply vinegar solution, blot. 5. Rinse thoroughly with water, blot until dry.
Wine	Reddish or purplish, absorbed • Contains alcohol, sugar, tannin, coloring matter.	<ol style="list-style-type: none"> 1. Apply detergent solution, blot. 2. Apply vinegar solution, blot. 3. Apply ammonia solution, blot. 4. If necessary, bleach with 3-5% hydrogen peroxide or sodium perborate. 5. Rinse thoroughly with water, blot until dry.

Appearance Care/Seat Covering and Vinyl Trim

Description

Your Glastron seat coverings and trim are expanded vinyl. The vinyl is water-proof and mildew resistant.

Cleaning

Most dirt and spills will wipe clean with a damp rag or sponge but scrubbing with soap and water or with a vinyl cleaner is sometimes necessary.

The surface is slightly porous and certain bad spills may leave a stain which sets. Do not use solvents or abrasive detergents in cleaning.

Care

Treat vinyl weekly (daily in severe climates or salt use) with a vinyl surface treatment cleaner.

When possible, exterior cushions should be removed and placed out of the sun when not being used.

When cushions are left in the boat for winter storage, open zippers and insert a small blunt object to elevate material away from foam for venting purposes. If seats can be folded down, the folded position is the best for storage.

Certain deluxe interiors feature seamed vinyl seat covers, and the seams will allow the foam cushions to absorb water. Therefore these seats should be covered when not in use or when washing down.

Curtains and Tops

Cleaning

Glastron curtains and tops are manufactured from high quality materials. This material is weather, rot, mildew and water resistant.

When cleaning your boat you should hose down all the fabrics and scrub with soap and a soft bristled brush. Rinse thoroughly.

For extreme cases of soil or mildew, a mild solution of ammonia and water may be applied, scrubbed and followed by a complete rinsing.

Should a leak occur along the seams of your top you may easily remedy the problem by rubbing a stick of paraffin along the affected area or by applying a coating of Scotch Guard.

Snaps and zippers are rust resistant, but should be regularly lubricated. Vaseline, silicone spray or paraffin are some lubricants that are effective. Zippers should never be forced.

Never fold or roll damp or wet fabric up without proper ventilation. Let air dry before storing. This will reduce the possibility of mildew.

Nautical Terms

aboard; on or in the boat.

aft, after; part of the boat toward the stern.

aground; touching the bottom.

amidships; toward the center from side to side or front to rear.

anchor; a hooked piece of iron for gripping the bottom.

anchor light; a 32 point white light shown by a ship at anchor.

anti-fouling paint; paint applied to a boat's bottom to keep weeds and barnacles from clinging to the bottom.

ashore; on shore.

astern; behind the boat, go astern to move backwards.

athwartships; at right angles to the centerline of the boat.

bail; to scoop water from the bottom of a boat with a bucket or container.

barnacles; small, hard-shelled marine animals which are found attached to pilings, docks and bottoms of boats.

beam; the width of a boat at its widest point.

bearing; the direction of an object from the boat, either relative to the boat's direction or to compass degrees.

below; under the deck.

berth; a bunk or bed on board a boat.

bilge; the bottom of a boat below the flooring.

bilge pump; pump used to remove water from the bilge.

binnacle; a stand holding the steering compass.

blower; a fan device used to ventilate fumes from below.

boarding; entering upon or climbing into a boat.

bow; the forward part of the boat's hull.

bow line; a mooring line attached to the boat's bow.

bridge; the navigating deck of a boat.

bridge, flying; an open deck above the bridge, usually with a duplicate set of engine controls and navigating facilities.

broach; to turn sideways to the seas when running before them.

bulkhead; any vertical partition (wall) on a boat. Also a seawall to retain the earth.

Can buoy; a black or black striped buoy of round shape with a flat top.

capstan; a mechanically- or hand-driven machine with vertical axis used on deck to haul in the anchor.

cast off; to let go.

chafe; to wear by steady rubbing.

chafing gear; protective coating as to absorb the rubbing.

chain; the anchor chain usually stores forward in the cabin and runs up on deck through a hawse pipe.

chart; a nautical map.

check; to hold back or stop a line gradually.

chocks; oval-shaped castings fore and aft through which the anchor line and dock lines may pass.

cleat; a piece of wood or metal with projecting arms or horns, used for securing lines.

coaming; vertical wood or fiberglass railing around the cockpit or hatches to keep water from getting in.

cockpit; an opening in the deck from which the boat is handled.

companion ladder; the stairs leading down into the cabin.

compass; device used to determine directions on shipboard.

davit; a curved spar or pair of spars with sheaves in their ends and which can be rotated out over the side to hoist a boat or dinghy easily from the water onto the deck.

deck; an open surface on which the crew and passengers walk.

dinghy; small boat used as a tender by a yacht.

displacement; the volume of water displaced by the hull. The displacement weight is the weight of this volume of water.

dock; a protected water area in which boats are moored. The term is often used to denote a pier or a wharf.

drogue; a sea anchor.

ebb; the falling tide.

ensign; the national flag of a vessel.

fathom; a measure of depth; six feet.

fender; a cushion, usually cylindrical in shape, used to protect the sides of a boat from rubbing against a dock or another vessel.

fend off; to push off with a boat hook or by hand to avoid sharp contact with a dock or another vessel.

flood; the rising tide.

flukes; the palms or broad portions of an anchor which hold into the ground.

fore; the term applied to portions of a boat near the bow.

fore and aft; in the lengthwise line of a boat.

freeboard; the shortest distance from the water line to the lowest part of the deck.

galley; the cooking area of a boat.

gear; a broad term applying to rigging or to the personal effects of people on board.

gimbals; a device in which the compass or galley stove is set to keep it level when the boat heels.

ground swell; the general heaving of the sea in the absence of waves.

ground tackle; a group term for all gear used on anchoring a boat.

gunwale; (pronounced gun'l) the rail or upper edge of a boat's side.

hatch; an opening from the deck to the interior of the boat.

head; a boat's toilet.

heave to; a boat is said to be heave to in a storm when she is without forward progress, but carrying a sea anchor and just enough power to hold her position.

helm; the wheel or tiller controlling the rudder.

hull; that part of a boat from the deck down.

inboard; toward the center of a boat.

inboard/outboard; also known as stern drive and I/O, a motor installation with inboard engine directly geared to an outboard drive unit.

kedge; an auxiliary anchor of lesser holding power than the main anchor. Often carried out by a small boat and used for warping a vessel ahead.

knot; a measure of speed indicating nautical miles per hour (a nautical mile is equal to one minute of latitude; 6076.115 feet). Knots times 1.15 equals miles per hour. MPH times .87 equals knots.

Latitude; angular distance north or south of the equator.
lee; the side opposite to that from which the wind is coming.
leeward; (pronounced lu-ard) the direction toward which the wind is blowing.
life line; lines along the rail of a boat supported by stanchions.
limber hole; hole drilled in the side of a stringer at the base so water can reach the bilge pump.
list; the lean of a boat to one side or another due to weight on board.
locker; a storage compartment on shipboard.
L.O.A.; Length Over All.
log; an instrument for determining a boat's speed.
log book; a record of all matters pertaining to a boat's position or operation.
longitude; angular distance east or west of the prime meridian at Greenwich, England.
loran; a navigational device which affords lines of positions derived from signals emitted from pairs of transmitting stations.
lubber line; a mark or permanent line on a compass that shows the center line of the boat.

Midships; same as amidships, indicating the center of the boat.
mooring; an anchor embedded in the bottom. A chain from it to a buoy to the boat, usually with a pick-up can or buoy to facilitate getting the pennant on board.

Nautical mile; a unit of measure equal to one minute of latitude (6076.115 feet).
navigation; the art of conducting a boat safely from a known position to a known destination.
no wake zone; an posted area where the speed of the boat should slow enough as to not produce a wake.
nun buoy; a red or red striped buoy of conical shape.

Over all; the measurement from the extreme forward end to the extreme after end of the deck.

Pad eye; a fitting consisting of a plate with a metal eye, permanently secured to a part of the boat.
part; to break.
pennant; a three-sided flag.
personal flotation devices (PFDs); usually cloth jackets made with pads of buoyant material to sustain a person in water.
pitch; the measure of angle of a propeller blade. Also the alternate up and down movement of the boat's bow and stern.
port; the left side, looking forward. Also an opening; porthole.
propeller; a group of two, three or four helical blades which drive a boat through the water.

Tub rail; a strip of molding extending outward from the boat's sides to protect the hull.
rudder; a flat piece of wood or metal attached upright to the boat's bottom at the stern to provide a means of steering for inboard boats.
rules of the road; the laws of navigation; their primary purpose is the avoidance of collisions.
run aground; the hull makes contact with the bottom.

Sea anchor; a drogue or drag.
sea cock; a valve, opening or shutting, a pipe connection through the hull.
sextant; a device used in celestial navigation to determine the altitudes at sun, moon and stars.
shank; the main body of an anchor.
shoal; shallow.
slip; a boat's berth between two piers.
slack; to ease off.
snub; to check quickly around a cleat.
soundings; to test the depth of the water with a lead line of fathometer.
spring line; a line from the bow aft or quarter forward to prevent fore and aft motion at a dock and to help hold the boat off the dock.
squatting; the tendency of the stern to sink low in the water at high speed.
starboard; the right side of the boat looking forward.
steady as you go; a command to maintain course and speed.
steerageway; sufficient speed to keep the boat responding to the rudder.
stern; the after end of the boat.
stern line; a mooring line attached to the boat's stern.
stove in; when the shell of a boat is smashed in by impact, the craft is said to be stove in.
stow; to pack away neatly.
stringer; strengthening strakes (boards) running horizontally along the inside of a boat at various distances up the sides from the bilge.
strut; the supporting piece which holds the propeller shaft in place between the propeller and the hull.
stuffing box; the hull fitting through which the propeller shaft passes, allowing the shaft to turn without leaking water.
sump pump; a pump used to remove water (usually in a shower stall).
swab; a floor mop.
swamp; to sink by taking water over the rail.

Tachometer; a meter which indicates the number of revolutions per minute.
tend; the direction of the anchor chain or rode toward the anchor.
top off; to fill a tank.
topsides; the sides of a boat between the waterline and rail.
transom; a flat stern at right angles to the keel, often bearing the boat's name and home port.
trim; a boat's balance when properly loaded.

Underway; a boat is underway when not secured to shore or bottom.

Wake; the path of a boat left astern in the water.
way; controlled motion through the water, when the boat is moving.
windlass; a winch used to raise the anchor.
windward; toward the direction from which the wind is coming.

Suggested Reading List

Damford, Don. *Anchoring*. 1985. (ISBN 0-915160-64-1). Seven Seas.

United States Coast Guard Auxiliary. *Boating Skills & Seamanship*. 8th ed. LC 74-164688. (Illus.). 1979. pap. text ed. (ISBN 0-930028-00-7). U.S. Coast Guard.

Bottomley, Tom. *Boatman's Handbook*, rev. ed. (Illus.). 316p. (Orig.). 1984. pap. (ISBN 0-688-03925-1, Hearst Marine Bk.). Morrow.

Whiting, John & Bottomley, Tom. *Chapman's Log & Owners Manual*. 192p. 1980. (ISBN 0-87851-801-0); deluxe ed. o.p. (ISBN 0-686-96737-2). Hearst Bks.

Strahm, Virgil. *Does Your Fiberglass Boat Need Repair?* LC 81-90093. (Illus.). 46p. (Orig.). pap (ISBN 0-9606050-0-2). Strahm.

Chapman, Charles F. & Maloney. *E.S. Chapman's Piloting, Seamanship & Small Boat Handling*. 56th rev. ed. (Illus.) 624p. 1983. (ISBN 0-87851-814-2, Pub. by Hearst Bks.); deluxe ed. (ISBN 0-87851-815-0). Morrow.

National Fire Protection Association. *Fire Protection Standard for Pleasure & Commercial Motor Craft*. 1984. (ISBN 0-317-07388-5, NFPA 302). Natl. Fire Prot.

Brotherton, Miner. *Twelve-Volt Bible*. 1985. Plastic comb. (ISBN 0-915160-81-1). Seven Seas.