

OWNER'S AND OPERATOR'S MANUAL





GLASTRON BOATS

A Genmar Company

P.O. Box 460

Little Falls, MN 56345

(320) 632-8395

glastron@brainerd.net

www.glastron.com

Owner's And Operator's Manual

Model/Number: _____

Hull Identification Number: _____

Date of Ownership: _____

Glastron Boats reserves the right to change, alter, and modify their finished boats, parts, and specifications included in this manual without notice. Optional equipment described in this manual may vary from model to model and year to year. Please consult with your Glastron Dealer for current information on standard and optional equipment.



Table of Contents

WELCOME ABOARD	1	PRE-LAUNCH & UNDERWAY.....	3
Owner's Manual Structure.....	1.1	Trailing.....	3.1
Responsibilities	1.2	Launching.....	3.2
Boat Records	1.3	Loading.....	3.4
Warranty	1.3	Fueling Recommendations.....	3.5
Boating Safety.....	1.5	Getting Underway	3.7
Safety Underway	1.10	Controls.....	3.8
Navigational Aids Chart.....	1.16	Pre-Cruise Check.....	3.10
Fire Prevention Guidelines	1.17	Starting Procedures	3.11
Weather	1.17	Trimming.....	3.13
Man Overboard	1.18	Engine Shut Down.....	3.15
Safety Equipment.....	1.18	Reloading Your Boat.....	3.15
Additional Recommended Equipment	1.21	Anchoring	3.15
Boating Laws & Regulations.....	1.21	Emergency Procedures.....	3.16
Illegal to Dump	1.21	Reacting to Emergencies	3.18
Glastron Boat Log (Form).....	1.23		
Glastron Cruise Log (Form)	1.24		
Glastron Fuel Usage Log (Form).....	1.25		
SYSTEMS & COMPONENTS	2	MAINTENANCE	4
Safety Labels.....	2.1	Service & Maintenance Schedule.....	4.1
Systems.....	2.3	Troubleshooting Chart.....	4.5
Typical Instrument Panel Schematic	2.4		
Ski-Fish Bow Panel	2.5	CARE & APPEARANCE	5
Outboard Wiring Assembly	2.6	Deck and Hull Care.....	5.1
Typical Engine Harness Schematic	2.7	Upholstery	5.3
Components.....	2.11	Windshields and Windows	5.4
Bow Panel	2.15	Carpeting.....	5.4
Trolling Motor	2.16	Canvas.....	5.4
Livewell.....	2.17		
Additional Safety Information		WINTERIZATION & STORAGE	6
(Ski'n Fish Models)	2.18	Removing Boat from Water	6.1
Additional Information (Cruiser Models).....	2.18	Prior to Storage	6.1
Typical Cruiser 12 Volt DC Cabin Schematic	2.19	Engine, Systems & Components.....	6.1
Typical 110 Volt AC Panel Wiring Diagram.....	2.21	Interior Cleaning	6.3
Typical 110 Volt AC Panel Wiring Diagram.....	2.22	If You Store Your Boat on a Trailer	6.4
Typical Cruiser Engine 12 Volt DC Schematic...	2.23	Recommissioning.....	6.4
Components.....	2.27		
		NAUTICAL TERMINOLOGY.....	7



Congratulations on the purchase of one of the finest pleasure boats in the world. It has been proudly built to give you many years of boating pleasure.

We've done our part—

Pride of craftsmanship is your assurance that you've bought the very best. All Glastron models meet or exceed U.S. Coast Guard safety standards relating to load and horsepower capacity, flotation, electrical, steering, ventilation, and fuel systems, in effect the date of manufacture.

But our work is not over—

We stand behind every boat we build. Your Glastron dealer will assist you with registration of your boat for warranty. They will be happy to help you maintain your boat and answer questions concerning warranty, performance, accessories, and service. The warranty card must be filled out and sent to establish your warranty.

Now it's your turn—

Your Owner's Manual is intended to help you become familiar with your new boat. While this manual contains information to assure safe and enjoyable boating, it does not provide everything you need to know. Above all, take time to know your boat. Read the material supplied by the manufacturer of your engine. Your owner's manual does not supersede or change any of their specifications, operation, or maintenance instructions. Also read all literature supplied with your boat by the manufacturers of the various accessories which are used on your boat. Glastron Boats recommends that you read the boating literature published by your State Boating Agency.

OWNER'S MANUAL STRUCTURE

Your owner's manual should be used as a guide to familiarize yourself with all the systems and components onboard your Glastron boat. The procedures in this manual will assist you with safe and proper operation, and maintenance of your boat. The level of information may be general in some cases and more detailed in others.

Suppliers of the more complex components such as engine, electronics, pumps, and refrigerator, supply their own instructional manuals delivered to you when you purchased your boat. These suppliers maintain their own manufacturer's warranty and service facilities. It is essential that you fill-out each warranty card and mail them to each manufacturer informing that you are a registered owner of their product(s). Record all information regarding these products on the "Boat Log" located in this chapter under Boat Records. Keep the Boat Log in a safe place at home and never onboard the boat.

Your owner's manual is designed with the boat owner/operator in mind. The intent of the manual is to provide sufficient information to allow the user to safely operate and maintain your new Glastron boat. Your Owner's Manual is structured as follows:

WELCOME ABOARD

Included in the Welcome Aboard Chapter of your manual is our welcome aboard message to all new Glastron boat owners, construction and standards, dealer and owner responsibilities, warranty, important logs and this summary of your owner's manual.

The Safety portion of this chapter contains safety recommendations, safety information and practices, weather

precautions, and safety equipment (onboard and underway). Additionally, specific safety warnings and comments are located throughout your owner's manual (and on your boat), therefore you should carefully read the entire manual.

SYSTEMS & COMPONENTS

The Systems & Components Chapter provides illustrative information covering system items such as electrical, fuel and water systems onboard, as well as specified information regarding the components installed on your new Glastron boat.

PRE-LAUNCH & UNDERWAY

The intent of the Pre-launch & Underway Chapter is to familiarize the boat owner/operator with necessary information in preparation of trailering, launching and putting your new Glastron boat in the water. Encountering underway adjustments and situations is also explained.

MAINTENANCE

Recommendations for keeping your new Glastron boat in sound operational condition, making adjustments, frequency of checks and inspections, and a troubleshooting chart are all introduced in the Maintenance Chapter.

CARE & APPEARANCE

Provided in the Care & Appearance Chapter are inspections, cleaning, and maintenance for your boats fiberglass, deck and canvas.

WINTERIZATION & STORAGE

The Winterization & Storage Chapter presents information and procedures to follow when your boat will be winterized or stored for extended periods of time.

BOATING TERMINOLOGY

Terms and definitions associated with your boat that you will encounter while participating in recreational boating can be found in the Boating Terminology Chapter.

RESPONSIBILITIES

Glastron Boat Owner

1. Set up an appointment with your Glastron dealer to discuss all warranties. Complete and return the Glastron Boats Limited Warranty Registration card, and keep a record of the hull number for future reference.
2. Inspect the boat at the time of delivery to verify that all systems and components are operating safely and acceptably. Read all manuals and instructions.
3. Operate all equipment in compliance with the manufacturer's instructions.
4. Schedule an appointment with your Glastron dealer to spell out the pre-delivery engine service record. Sign this record to indicate that it has been explained to you in detail by your dealer.
5. Schedule with your dealer your boat's 20 hour check-up.

IMPORTANT: Make sure that your dealer checks the engine alignment during your boat's 20 hour check-up. The engine alignment check should be performed in accordance with the recommended procedures as stated by the engine manufacturer in your engine owner's manual. Failure to do so could result in drive train damage and is not covered under the Glastron Boats Warranty.

6. Glastron Boats recommend that you reference your engine warranty certificate for initial inspection and service requirements.
7. Perform or provide for the warranted periodic maintenance outlined in this manual and all related service guides and manuals.

Glastron Boat Dealership

1. Your Glastron dealer will discuss the terms of all warranties, and emphasize the importance of registering each warranty with the appropriate manufacturer.
2. Your Glastron dealer will provide instruction for obtaining warranty service.
3. Your Glastron dealer will cover each item on the pre-delivery service record with you, and then sign it to certify that all work has been suitably performed.
4. Your Glastron dealer can provide you with a comprehensive instruction in the operation of your boat and all systems and components installed onboard, just ask your dealer.

BOAT RECORDS

You have been provided with three very useful forms at the end of this section. The **Boat Log** is used to write down all of your boat's important information and data regarding the major components installed on your boat. Once you have entered all the information, remove the Boat Log from your Owner's Manual and keep it in a safe place. **Do not** keep this log onboard your boat.

The purpose of the **Cruise Log** is to provide a record of your destination, departure and return times, boat description, passenger list, and other information regarding your

trip expectations. At the bottom of the log is a place to list emergency telephone numbers in case you encounter trouble underway and your return time has expired.

The **Cruise Log** is to be left ashore with a responsible person. In the event of an emergency, this log is to be reported to the proper authorities. The person reporting this information should list their name, location, and telephone number on the Cruise Log. You should make several copies of this log to use throughout the boating season.

The **Fuel Usage Log** is an easy way to log information covering engine hours, fuel consumption, miles traveled, RPMs, Average MPH, and GPH (gallons per hour). Observance of the information logged will forewarn you of scheduled maintenance and inspections.

WARRANTY

Your Glastron Boat is backed by a Limited Express Warranty. The complete warranty follows the Boating Terminology chapter at the end of this manual. It is important that you are aware of its terms. If a problem arises with your Glastron boat as a result of workmanship or materials, contact your Glastron dealer as soon as possible to determine if it may be covered by the warranty. Please have your hull identification number, and necessary model numbers on hand for the items that require service or repair. Your hull identification number is located below the rub rail on the starboard rear corner of your boat.

NOTE: There are items which are **not covered** by this warranty, including:

- Incidental and consequential damages (storage charges, telephone or rental charges of any type, inconvenience or loss of time or income.)

- Damage caused by neglect, lack of maintenance, accident, abnormal operation, improper installation or service.
- Haul-out, launch and towing charges.
- Transportation charges and/or travel time to and from a repair facility.
- Travel time to customer's home or marina.
- Service requested by customer other than that necessary to satisfy the warranty obligation.
- Oils, lubricants or fluids used in normal maintenance.
- Air freight, next-day or second-day air, or any special delivery fees unless pre-approved.
- Gelcoat cracking, yellowing, crazing or blistering, plexiglas, canvas, vinyl or tape **unless noted on equipment check off list** at time of delivery.
- Engines, drive trains, controls, props, batteries, or other equipment or accessories carrying their own individual warranties.
- It is important to note that on many of the components in our boats, i.e. stoves, refrigerators, generators, trim tabs, etc., the warranties are extended by the component manufacturer. (Most component manufacturers repair or replace the defective component if it is returned to them.) The customer is responsible for all travel time, freight, or postage costs. We will pay for the cost to remove and replace the component.
- Engines, parts or accessories not installed by Glastron Boats.
- Plexiglas windscreen breakage, rainwater leakage through convertible tops, minor gelcoat discoloration, cracks, crazing, or air voids.
- Windshield and canvas top leakage: A certain amount of leakage can occur at the fasteners and at the stitching.
- Minor gelcoat discoloration or chalking may occur if regular washing and waxing has been neglected. Proper care of the gelcoat finish is the responsibility of the owner.
- Hull blisters that form below the waterline: Osmosis blistering is not covered by our limited warranty. The phenomenon is most likely to occur in warm, fresh water. However, it can also occur in saltwater. Any boat left in the water for any period of time is susceptible. Nearly all the marine bottom paint manufacturers today offer coatings that help protect the hull against osmosis blistering. **We highly recommend that you add a protective coating to your hull.**
- Normal deterioration, i.e. wear, tear, or corrosion of hardware, vinyl tops, vinyl and fabric upholstery, plastic, metal, wood, or trim tape.
- Hardware: Metal hardware that has rusted or pitted will not be replaced under warranty. You should keep this hardware clean and wiped down with a light oil (WD40).
- Vinyl tops: Glastron does not warrant damage that might occur when a boat is being towed on a trailer with the top up, and does not warrant shrinkage, mildew, or other normal deterioration.
- Any boat used for commercial purposes: This includes boats used for charter purposes or time-share.

- Any defect caused by failure of the customer to provide reasonable care and maintenance.

By signing the warranty registration card you, the new owner, indicate an understanding of the terms and conditions of the Limited Warranty. The warranty registration card should be properly completed by the dealer, signed by the new owner, and returned to us within fifteen (15) days after the original purchase in order to validate the warranty. Be sure to keep the Owner's Registration Card for your records.

All boat manufacturers are required by The Federal Boat Safety Act of 1971 to notify first time owners in the event any defect is discovered "which creates a substantial risk of personal injury to the public." In order for us to comply with that law, if it becomes necessary, it is essential that your warranty registration card with the owner's name, address, and boat serial number be completed and mailed to Glastron Boats, 700 W. River Road, Little Falls, MN 56345.

The limited warranty for your boat is transferable and can be extended to the next purchaser for the remainder of the warranty period by notifying Glastron Boats in writing within 15 days of the transfer, by using the warranty registration transfer form found at the end of this manual. The transfer request must be accompanied by a copy of the title/registration and the \$250.00 transfer fee.

BOATING SAFETY

Your owner's manual uses five levels of advisory and hazard statements to alert you to special information, operating procedures or safety precautions. All statements begin with a signal word to identify the importance of the statement. Statement levels follow this order (increasing importance):

Advisory Statements

Advisory statements forewarn conditions that effect equipment operation, maintenance and servicing practices and occur in two levels:

Level 1 - NOTE

Signals a general advisory statement that clarifies or highlights a particular section of text.

Level 2 - IMPORTANT

Used to signal the possibility of damage to equipment or associated components.

Hazard Statements



This symbol means "pay attention!" Here is important information for your safety. If you don't follow these instructions, you can damage your boat, hurt yourself or someone else or, even worse, have a fatal accident.

The use of hazard statements is determined by the likely consequence of the warning with regard to severity (minor injury, severe injury, death), and the probability of severity (COULD result in, WILL result in).

Level 3 - Caution

CAUTION

CAUTION: This symbol and signal word indicate a potentially hazardous situation. If you ignore this safety message, property damage or minor or moderate personal injury MAY or CAN result.

Level 4 - Warning

WARNING

WARNING: This symbol and signal word indicate a potential hazard. If you ignore this safety message, serious injury or death CAN result.

Level 5 - Danger

DANGER

DANGER: This symbol and signal word indicate an immediate hazard. If you ignore this safety message, serious personal injury or death WILL result.

Recommendations

Boating safety and the safety of your passengers is YOUR responsibility. You should fully understand and become familiar with the following safety precautions before launching your Glastron boat.

1. Your boat and equipment should be kept in safe operating condition. Regularly inspect the hull, engine, safety equipment and all other boating gear.

2. Use extreme CAUTION while fueling your boat. Become familiar with the capacity of your boat's fuel tank and fuel consumption for commonly used RPMs. Avoid fueling at night except under well-lit conditions. Gas spills are hard to see in the dark.
3. Keep enough fuel on board for your planned cruising requirements as well as for changes in your plans due to adverse weather or other situations. We recommend the 1/3 rule: use 1/3 of your fuel to reach your destination, use 1/3 to return, and keep 1/3 in reserve.

WARNING

WARNING: Each time you fill up, inspect fuel lines for leaks and hose deterioration, and be sure the engine compartment is free of gasoline vapors. Leaking fuel is a fire and explosion hazard and can cause severe injury or death. The use of alcohol modified fuels can cause deterioration of the fuel system.

4. All regulation lifesaving and fire extinguishing equipment onboard, must be eye-catching, unrestricted and in safe operating condition. All passengers should become familiar with the operation and location of all equipment.
5. Keep an eye on the weather. Be aware of possible changing conditions by monitoring local weather broadcasts prior to departure. Strong winds and electrical storms should be personally monitored .
6. Accurate up to date charts of your boating area should always be onboard.
7. Before departure file your Cruise Log with a responsible person ashore.

8. Always operate your boat with consideration, courtesy and common sense.
9. At least one other passenger aboard should be indoctrinated on the basic operating procedures for handling your boat, in the event you unexpectedly become unable to do so.
10. Never allow passengers to ride on areas of your boat other than designated seating areas.
11. All passengers should remain seated while the boat is moving.
12. Never use the swim platform or boarding ladder while the engine is running. Be aware of the location of the drive units or propellers before entering the water from the swim platform ladder.
13. Study and obey the Rules of the Road. Always maintain complete control of your boat.
14. Never overload or improperly load your boat.

NOTE: The presence of the boat's maximum weight capacity plate does not override your responsibility to use common sense or rational judgment. The capacity of your boat is reduced by turbulent water and other adverse weather conditions. You should have prior knowledge of existing water and weather conditions before getting underway.

Water Sports

Advancements in technology have created new and improved products for water sports enthusiasts. Water skiing, kneeboarding and riding on popular inflatable towed apparatus requires an increased safety awareness in the operation of your boat. If you are going to swim near your boat, first turn off the boat's engine and anchor the boat.

⚠ WARNING

WARNING: Glastron boats are not designed and should not be used for the pulling of Para-sails, kites, gliders, or any other device that is designed to become airborne when drawn behind a boat.

SAFETY GUIDELINES

1. Always wear a U.S. Coast Guard approved personal flotation device.
2. Have an aft-facing observer aboard to inform driver of what is taking place behind the boat.
3. Never participate in these water sports near beaches or in restricted areas.
4. Stay out of channels and other heavily traveled waterways.
5. Swim only in areas designated as safe for swimming. These are usually marked with a swim area buoy (Figure 1.1). Do not swim alone or at night.

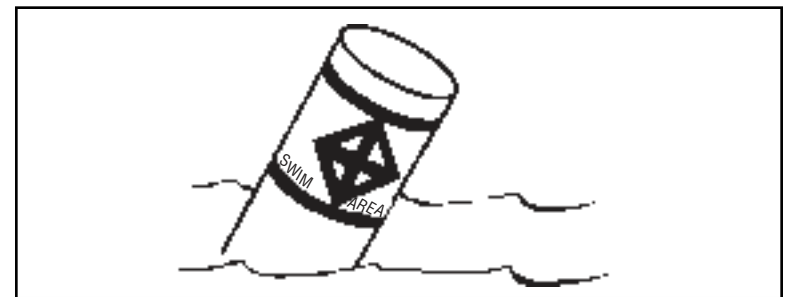

FIGURE 1.1 SWIM AREA BUOY

6. Do not allow anyone near the propeller(s), even when the engine is off. Propeller blades can be sharp and can continue to turn even after the engine is off. Stay at least 150 feet away from areas marked by a diver down float (Figure 1.2).

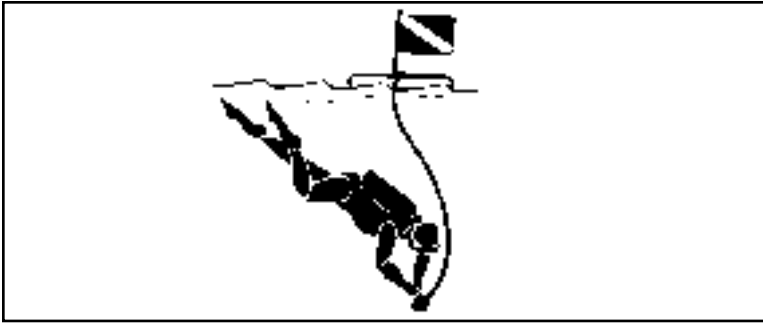

FIGURE 1.2 DIVER DOWN FLOAT

Water Skiing

Water skiing presents a special set of precautions to observe in recreational boating. The following precautions will reduce the hazards while water skiing.

1. Water ski only in safe areas, away from other boats and swimmers, out of channels and in water free of underwater obstructions. Be considerate of others you share the water with.
2. Only individuals that are capable swimmers should be allowed to water ski.
3. Be sure the skier is wearing a PFD (personal flotation device). A properly designed ski vest is intended to keep a stunned or unconscious person afloat.
4. Always carry a second person on board to observe the skier so the driver can give full attention to the operation of the boat and waters ahead.

5. Approach a skier in the water from the lee side (opposite to that from which the wind blows), and be certain to stop your motor before coming in close proximity to the skier.
6. Give immediate attention to a fallen skier. He or she is vulnerable in the water alone and is difficult to see by other boaters. Be careful not to swamp the boat while taking a skier aboard.

▲ WARNING

WARNING: Switch engine off before taking skiers aboard from in the water. Do not leave engine running in neutral; if the shift is accidentally engaged the skier could be seriously injured by the propeller.

7. Do not water ski between sunset and sunrise. It is illegal in most states.
8. Always attach the water ski rope to the ski pylon. Do not use the ski pylon to tow your boat or other boats.

Figure 1.3 identifies a set of hand signals recommended by the American Water Ski Association (AWSA). Skier, observer and boat operator should all know and understand these seven (7) simple signals from the skier. The observer must inform the driver of the skier's hand signals. The driver must give full attention to operating the boat and the waters ahead.

For more information about water skiing, Please contact the American Water Ski Association, 799 Overlook Drive, Winter Haven, Florida 33884 (1-800-533-2972).

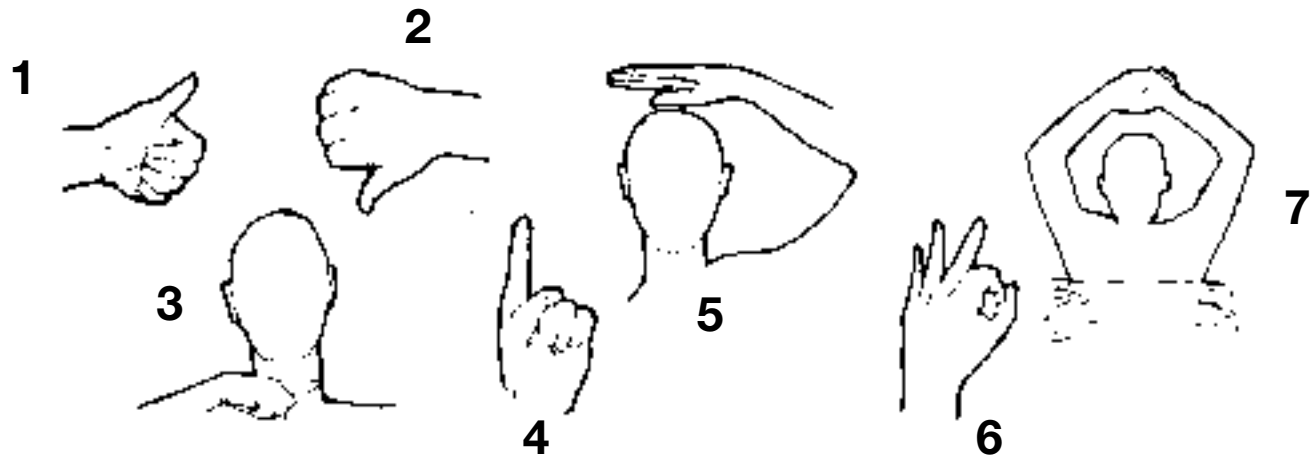

1. **Thumb Up:** Speed up the boat.
2. **Thumb Down:** Slow down the boat.
3. **Cut Motor/Stop:** Immediately stop boat. Slashing motion over neck (also used by driver or observer).
4. **Turn:** Turn the boat (also used by driver). Circle motion—arms overhead. Then point in desired direction.
5. **Return to Dock:** Pat on the head.
6. **OK:** Speed and boat path OK. Or, signals understood.
7. **I'm OK:** Skier OK after falling.

FIGURE 1.3 – AWSA WATER SKIING HAND SIGNALS

Drugs and Alcohol

In the best interest of safety, you SHOULD refrain from the use of Drugs and/or Alcohol while operating your boat. Operation of motorized vessels while under the influence carries a significant penalty. The use of Drugs and/or Alcohol will decrease reaction time, impede judgement, impair vision, and inhibit your ability to safely operate a boat.

Safe Boating Courses

Your local U.S. Coast Guard Auxiliary and the U.S. Power Squadrons offer comprehensive safe boating classes several times a year. You may contact the Boat/U.S. Foundation at 1-800-336-BOAT (2628), or in Virginia

1-800-245-BOAT (2628) for a course schedule in your area. Also contact your local U.S. Coast Guard Auxiliary or Power Squadron Flotilla for the time and place of their next scheduled class.

Rules of the Road

Your Glastron boat is subject to U.S. Coast Guard-enforced marine traffic laws known as “**Rules of the Road.**” There are two sets of rules — the United States Inland Navigational Rules and the International Rules. The United States Inland Rules are applicable to all vessels inside the demarcation lines separating inland and international waters. The “**Rules of the Road**” can be obtained from your local U.S. Coast Guard Unit or the United States

Coast Guard Headquarters (1300 E. Street NW, Washington, D.C. 20226) in the publication titled, “**Navigational Rules, International-Inland.**”

“**Aids to Navigation**” (U.S. Coast Guard pamphlet #123) explains the significance of various lights and buoys. This and other pamphlets, including the “**Boating Safety Training Manual,**” and “**Federal Requirements For Recreational Boats**” are also available from the U.S. Coast Guard Headquarters.

Because of proposed alterations in buoys and markers, Glastron Boats advises you to contact the U.S. Coast Guard to stay informed of impending changes. If you have a ship-to-shore radio telephone onboard, heed storm warnings and answer any distress calls. The spoken word “MAYDAY” is the international signal of distress. “**MAYDAY**” should **NEVER** be used unless there is present danger, an emergency, and you are in need of immediate assistance.

SAFETY UNDERWAY

General Rules of Seamanship

1. Cross waves at right angles.
2. When caught in heavy water or squalls, head your boat either directly into the waves or at a slight angle. Reduce your speed, but maintain enough power to maneuver your boat safely.
3. Keep your speed under control. Respect the rights of boats engaged in fishing, swimming, water skiing, or diving.
4. When meeting a boat head-on, keep to the right.
5. When two boats cross, the boat to the right or starboard has the right of way.

6. When overtaking or passing, the boat being passed has the right of way.

Additional Underway Information

- Always be aware of local laws on noise limits. Noise means engine noise, radio noise or even yelling by the people on your boat. Good seamanship demands that you operate your boat quietly so as not to infringe on the rights of others. Don’t use thru-transom exhaust unless you are well off shore.
- You are responsible for any damage or injury caused by your boat’s wake. Observe no wake speed zone warnings. Operate you boat with regard for the safety of other boats and people in your boating area.
- Keep your engine will tuned to decrease exhaust hydrocarbon emissions that pollute the air and water.

Carbon Monoxide

▲ WARNING

WARNING: Carbon monoxide (CO) can be harmful or fatal if inhaled. Brain damage or death can occur if exposed to carbon monoxide. Keep exhaust outlets clear of blockage. Provide adequate ventilation. Open hatches, doors, windows and vents to insure adequate ventilation. Close engine compartment doors and hatches when engine or generator is running. Avoid operating the boat for extended periods of time at idle speed and be sensitive to weather conditions that may prevent CO from dissipating into the air.

Carbon monoxide accumulation is affected by vessel geometry; hatch, window and door openings; ventilation openings; proximity to other structures; wind direction; vessel speed; and a multitude of other variables.

NOTE: Boats fueled by diesel have limited carbon monoxide present in the exhaust in comparison to gasoline engine exhaust. However, the boat owner should still be aware of the causes and effect of carbon monoxide which may occur in different boating situations.

PROPERTIES AND CHARACTERISTICS OF CARBON MONOXIDE

1. Carbon monoxide is a colorless, odorless and tasteless gas that is a natural by-product of internal combustion. It is commonly referred to as CO.
2. CO weighs about the same as air so it does not rise or fall like some other gases, but will distribute itself throughout the space.

HOW A PERSON IS AFFECTED BY CARBON MONOXIDE

Carbon monoxide is absorbed by the lungs and reacts with blood hemoglobin to form carboxyhemoglobin, which reduces the oxygen carrying capacity of the blood. The result is a lack of oxygen for the tissues with the subsequent tissue death and, **if prolonged, death of the individual.**

EFFECTS OF CARBON MONOXIDE

Carbon monoxide in high concentrations can be fatal in a matter of minutes. Lower concentrations must not be ignored because the effects of exposure to CO are cumulative and can be just as lethal over time.

SYMPTOMS

Initial reactions to CO poisoning can easily be mistaken for sea sickness. One or more of the following symptoms can signal the adverse effect of CO accumulation:

1. Watering and itchy eyes
2. Flushed appearance
3. Throbbing temples
4. Inattentiveness
5. Inability to think coherently
6. Ringing in the ears
7. Tightness across the chest
8. Headache
9. Drowsiness
10. Incoherence
11. Nausea
12. Dizziness
13. Fatigue
14. Vomiting
15. Collapse
16. Convulsions

NOTE: The order of the above list is generally the sequence of appearance of symptoms. However, the order of appearance may change for different people.

TREATMENT (Evacuate, Ventilate, Investigate, Take Corrective Action)

If you suspect CO poisoning, immediately take the following steps:

1. Move the person to fresh air.
2. Administer oxygen if available.
3. Contact Medical help.
4. If the victim is not breathing, perform artificial respiration per approved CPR procedures until medical help arrives and takes over.
5. Ventilate area.

- Investigate source of CO and take corrective action.

Prompt action can make the difference between life and death.

INSPECTION

Look and listen for leaks in the exhaust systems of both the generator and propulsion engine(s). Look for discoloration around joints in the system (water leaks, carbon, stains, etc.)

- Make sure all exhaust clamps are in place and secured.
- Make sure ventilation systems work and are not obstructed or restricted.
- Make sure gaps around the engine room plumbing and cableways and exhaust system doors, hatches, and access panels are minimized to reduce the opportunity for CO to enter the accommodation space(s).

OPERATION

Cold Start vs. Warm Start: CO production is greater while the combustion chamber surfaces and gas passages are cold versus when they are warm. A boat operator should:

- Pay attention to ventilating the boat.
- Orient the boat so it will allow the maximum dissipation of CO.
- Minimize the time spend on getting underway.

The following examples describe possible situations where carbon monoxide can accumulate within your boat while docked, anchored, or underway. Become familiar with

these examples and their precautions to prevent dangerous accidents or death.

AT ANCHOR

Engines and generators running or while the boat is anchored exhaust carbon monoxide that can accumulate near the hull of the boat. Do not stand or swim near exhaust output or outdrive when engine is idling or generator is running. Dangerous concentrations of CO can accumulate when a boat, generator or other engine operated device is operated while the boat is moored in a confined area such as:

- Boathouses,
- Proximity to sea walls, or
- Proximity to other boats.

Orient the boat for maximum dissipation of the exhaust or DO NOT run the boat or boat equipment for extended periods under these conditions. (See Figure 1.4.)

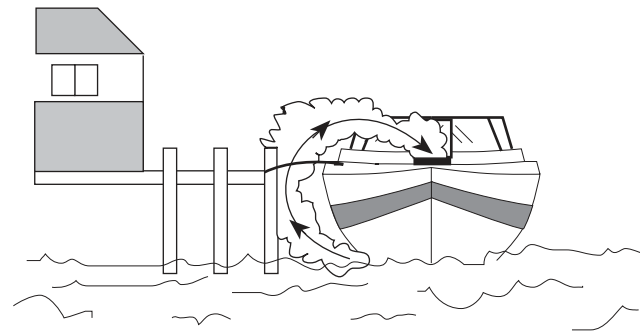

FIGURE 1.4 THE EFFECT OF SEA WALLS AND OTHER CONFINED SPACES

Carbon monoxide is emitted from any boat's exhaust. The operation, mooring, and anchoring in an area containing

other boats may be in an atmosphere containing CO not of the operator's making. An operator likewise needs to be aware of the effect of his actions on other boats. Of prime concern is the operation of an auxiliary generator with boats moored along side each other. Be aware of the effect your exhaust may have on other vessels and be aware that the operation of other vessel's equipment may affect the carbon monoxide concentration on your vessel. (See Figure 1.5.)

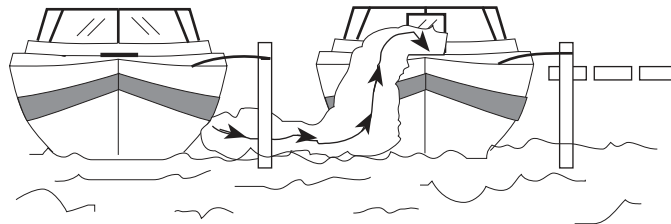

FIGURE 1.5 THE EFFECT OF BOATS MOORED ALONG SIDE

BACKDRAFTING (Station Wagon Effect)

Backdrafting or the "station wagon effect" is caused by air movement over or around a boat creating a low pressure area of suction area around the stern which can increase CO level on the boat. Backdrafting can be affected by relative wind direction, boat speed, and boat trim angle. (See Figure 1.6.)

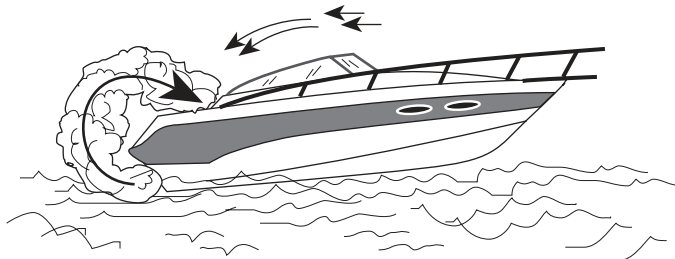

FIGURE 1.6 BACKDRAFTING - AIR FLOWS OVER BOAT AND BEHIND TRANSOM

Under certain speed and operating conditions the low pressure area may form in other regions and permit carbon monoxide to enter the hull through openings that are not on the back of the vessel. Boat factors which may affect CO concentration:

1. Inefficient trim angle. (See Figure 1.7.)

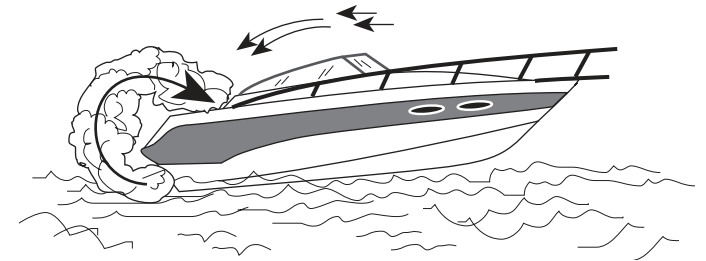

FIGURE 1.7 INEFFICIENT TRIM ANGLES

2. Excessive or unequally distributed weight.
3. Canvas configurations - under various conditions, adding or removing canvas may raise or lower CO levels. (See Figures 1.6, 1.7, 1.9.)

⚠ WARNING

WARNING: Hull exhaust from your boat can cause excessive accumulation of poisonous carbon monoxide gas within cockpit areas when using protective weather coverings (while underway or while stationary). Provide adequate ventilation when the canvas top, side curtains and/or back (aft) curtains are in their closed protective positions.

4. Opening and closing ports, hatches, doors, and windows may raise or lower CO levels on board a boat. (See Figures 1.8 and 1.9.)

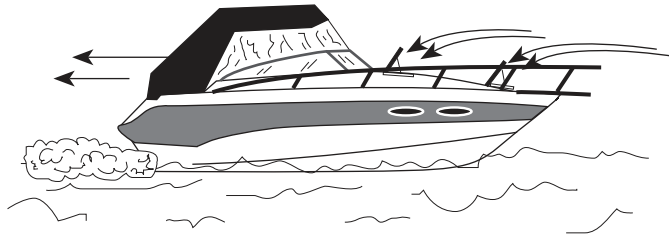

FIGURE 1.8 DESIRED AIR FLOW THROUGH THE BOAT

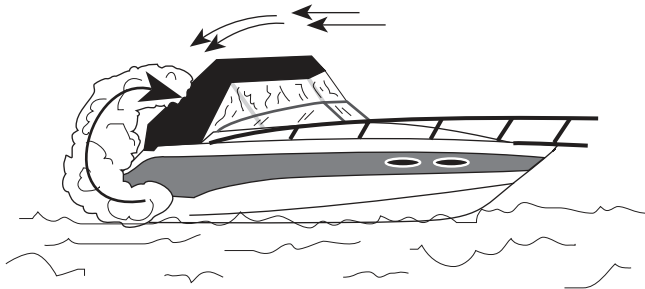

FIGURE 1.9 THE EFFECT OF CANVAS CONFIGURATIONS

VENTILATION OF ACCOMMODATION SPACES

Accommodation spaces need to be ventilated to introduce fresh air into the spaces. Ventilation method; e.g. windows, hatches, doors, and blowers; used to accomplish this may, under certain conditions, bring hazardous levels of CO into the accommodation spaces. Care should be taken to be aware of all prevailing conditions when using these ventilating methods.

PORTABLE GENERATOR SETS

Gasoline powered portable generators are available in the marine market place and are not an option available through Glastron. Portable generators will produce CO. These sets discharge their exhaust products in locations which can lead to an increase in the accumulation of car-

bon monoxide in the accommodation space. This equipment is not recommended for use on Glastron boats.

MAINTENANCE - ENGINE PERFORMANCE

Efficient engine performance is vital to minimizing CO production. The following items are those considered to have the greatest effect on increased CO production:

1. Fuel systems - fuel that is contaminated, stale or incorrect octane number.
2. Carburetors/Injectors
 - Dirty or clogged flame arrester.
 - Malfunctioning automatic choke plate or faulty adjustment of manual choke plate.
 - Worn float needle valve and seat.
 - High float level.
 - Incorrect idle mixture adjustment.
 - Dirty or worn injectors.
3. Ignition System
 - Fouled or worn spark plugs.
 - Worn points or incorrect gap on points.
 - Shorted or opened circuit high tension spark plug cables.
 - Incorrect ignition timing.
4. General
 - Worn piston rings and valves.
 - Engine temperature - cold running engines increase CO production. Engine cooling water system design and selection of thermostat(s) are primary considerations affecting engine operating temperature. Generally, an engine produces less CO if it operates at a relatively high temperature within manufacturer's specifications.
 - Exhaust Back-Pressure - certain alterations to the exhaust system may increase engine exhaust back pressure and CO production.

- Restricted engine room or compartment ventilation.

CO Detectors

Even with the best boat design and construction, together with the utmost care in inspection, operation and maintenance, hazardous levels of CO may still be present in accommodation spaces under certain conditions. Continuing observation of passengers for symptoms of CO intoxication can be supplemented by a marine grade alarm type CO detector installed in the accommodation space.

⚠ WARNING

WARNING: CO detectors should be marine grade and professionally installed and calibrated. Failure to do so may result in improper functioning and false reading.

Never disarm a CO detector. If a CO detector alarms, immediately ventilate the area and check passengers for symptoms of CO intoxication. See your Glastron dealer for assistance in diagnosing the cause of the alarm.

Navigational Aids Chart

The illustrated Navigational Aid Chart contains information concerning whistle signals, storm warnings, bridge signals, and buoy description and information.

Running Aground

If your boat runs aground, check persons aboard for injury and inspect damages to the boat or propeller(s). If possible, shift weight of passengers or gear to heel boat while reversing engine.

⚠ WARNING

WARNING: Do Not use deck hardware for towing. Glastron Boats recommends that you use a commercial towing service if your boat becomes grounded.

Collision

If a serious collision occurs you should first check the condition of all passengers aboard, then inspect your boat to determine the extent of damage.

1. Prepare to assist the other craft unless your passengers and/or boat is in danger.
2. If the bow of the other boat penetrated your boat's hull, prepare to block the opening once the boats are separated.
3. Shore up the hole with a spare PFD or bunk cushion from your boat.
4. While blocking the hole, trim weight of the boat (where hole exists) so that it is out of the water during repairs.
5. If the extent of damage places your boat in a possible sinking condition have all persons aboard put on their PFD (personal flotation devices).
6. If your boat has a ship-to-shore radio, contact (VHF channel 16 or CB Channel 22) the U.S. Coast Guard or other rescue authorities immediately.

Fire

A fire onboard your boat is a serious emergency, you must work quickly to implement safety procedures. If a fire occurs, immediately stop the engine.

NAVIGATIONAL AIDS CHART

REMEMBER THESE RULES

- OVERTAKING - PASSING:** Boat being passed has the right-of-way. **KEEP CLEAR.**
- MEETING HEAD ON:** Keep to the right.
- CROSSING:** Boat on right has the right-of-way. **Slow down and permit boat to pass.**

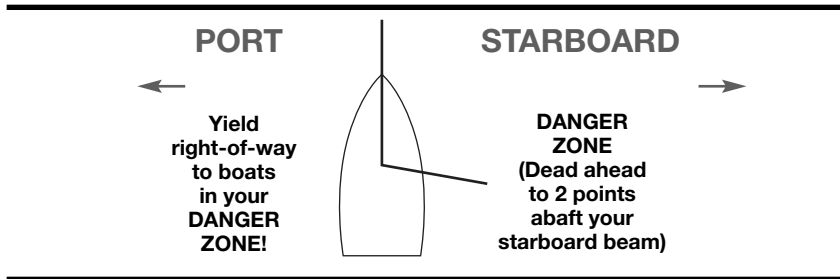

WHISTLE SIGNALS

- ONE LONG BLAST:** Warning signal (Coming out of slip)
- ONE SHORT BLAST:** Pass on my port side
- TWO SHORT BLASTS:** Pass on my starboard side
- THREE SHORT BLASTS:** Engine(s) in reverse
- FOUR OR MORE BLASTS:** Danger signal

BRIDGE SIGNALS

SOUND	VISUAL	DAY (Flag)	NIGHT (Lights)
VESSEL: Open	—●	□	○
BRIDGE: OK	—●	□	○
No	●●●●●	Same	Same
VESSEL: Replies:	●●●●●	◀■▶	◀●▶
RADIO: VHF CH. 13			

STORM WARNINGS

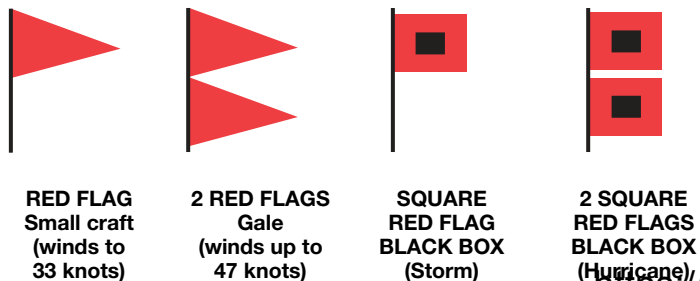

LATERAL AIDS AS SEEN ENTERING FROM SEAWARD

PORT SIDE ODD NUMBERED AIDS	SAFE WATER MID-CHANNELS OR FAIRWAYS NO NUMBERS-MAY BE LETTERED	STARBOARD SIDE EVEN NUMBERED AIDS
<ul style="list-style-type: none"> GREEN LIGHT ONLY FLASHING: [diagram] OCCULTING: [diagram] QUICK FLASHING: [diagram] ISOPHASE: [diagram] 	<ul style="list-style-type: none"> WHITE LIGHT ONLY MORSE CODE Mo(A) [diagram] Spherical: [diagram] RW SP "G" MR: [diagram] RW "A" LIGHTED BUOY: [diagram] G "9" FI G 4sec CAN: [diagram] G "7" C "7" SG DAYMARK: [diagram] G "1" LIGHTED AND OR SOUND: [diagram] RW "N" Mo (A) 	<ul style="list-style-type: none"> RED LIGHT ONLY FLASHING: [diagram] OCCULTING: [diagram] QUICK FLASHING: [diagram] ISOPHASE: [diagram] LIGHTED BUOY: [diagram] H "8" FI R 4sec NUN: [diagram] R "6" N "6" TR DAYMARK: [diagram] R "2"
	<p>PREFERRED CHANNEL NO NUMBERS-MAY BE LETTERED COMPOSITE GROUP FLASHING (2 + 1)</p> <p>[diagram]</p>	
	<p>LIGHTED</p> <p>PREFERRED CHANNEL TO STARBOARD TOPMOST BAND GREEN</p> <p>[diagram] GR "C" FI (2 + 1)</p> <p>[diagram] CAN [diagram] GR "L"</p> <p>[diagram] JG [diagram] GR "A"</p>	<p>LIGHTED</p> <p>PREFERRED CHANNEL TO PORT TOPMOST BAND RED</p> <p>[diagram] RG "B" FI (2 + 1)</p> <p>[diagram] NUN [diagram] RG "W" N "W"</p> <p>[diagram] JR [diagram] RG "B"</p>

1. Prompt all persons aboard to put on their PFD (personal flotation device).
2. If the fire is small, attempt to put it out with your fire extinguisher. If the fire is in the engine compartment, turn off the bilge blower. **Do Not** open the engine compartment. This feeds oxygen to the fire and flashback could occur.
3. If the fire gets out of control, execute a distress signal, and call for help if equipped with a ship-to-shore radio.
4. All persons aboard should jump overboard and swim a safe distance away from the flames.

Guidelines for Fire Prevention

- Check the bilge for fuel leaks
- Check cleaning products for flammability
- Ventilate when cleaning or painting
- Disconnect electrical system from power source when performing any type of maintenance
- Use extra caution when using exposed flame around urethane foam
- Extinguish smoking materials carefully
- Ensure ventilation systems are not obstructed
- Use only approved marine cooking and heating systems
- Open flames demand constant attention
- Keep flammable materials in approved containers
- Replace circuit breaker fuse with one of the same amperage

- Electrical appliances must be within rated amperage of boat circuits
- A qualified marine electrician should service the electrical system

IMPORTANT: All persons aboard should know the location and proper operation of the fire extinguishers.

WEATHER

Storms rarely appear without considerable advance notice. Accurate weather information from meteorological observation and reporting stations is available. Weather bureaus are known to have failures in their predictions or information gathering equipment. There is no substitute for a strong understanding of what action to take when the weather takes a turn for the worst. Many cruiser clubs fly weather signals. You should learn to recognize these signals, and monitor your local weather forecasts before leaving port.

Storms

The present and forecasted weather conditions are of primary consideration, but a threat of possible storms should always be a concern. Observance of the following information will help in your safety afloat if storms do occur:

- Keep a watch on the horizon for approaching storm indicators.
- Turn radio ON. Dial in local weather station and monitor forecast.
- The best possible situation is to return to a safe port if time allows.

- Close and secure all portals and hatches. Stow all loose gear below deck and tie-down any gear required to remain on deck.
- Reduce speed as the seas build. Prompt all persons aboard to put on their PFD (personal flotation devices).
- Place a sea anchor out over the stern to maintain the boat's bow into the seas. If there is no sea anchor onboard use a canvas bucket or any object that will offer resistance against the flow of the current.
- Radar reflectors (if installed on your boat) should be 18 inches diagonally and placed 12 feet above waterline.

Fog

Fog is a result of either warm-surface or cold-surface conditions. You can judge the likelihood of fog formation by periodically measuring the air temperature and dew point temperature. If the spread (difference) between these two temperatures is small you likely will incur a fog situation. Remember the following guidelines:

- As fog sets in, turn on navigation lights, take bearings and mark your position on the chart while continuing to log your course and speed.
- Prompt all persons aboard to put on their PFD (personal flotation devices).
- If equipped with sounding equipment, you should take soundings and match them with soundings on your charts.
- Station a person forward on the boat as a lookout.
- Reduce your speed. From time to time stop engine and listen for other fog signals.

- Sound the horn or fog bell intermittently to warn other boaters.
- If there is any doubt in continuing boat movement, anchor. Listen for other fog signals while continuing to sound the fog horn or bell.

MAN OVERBOARD

Should someone in the boat fall overboard:

- Act quickly—treat every situation as an emergency
- Move throttle to idle position and yell “Man Overboard”
- Immediately throw a Type IV PFD to the person in the water
- Have someone in the boat assume responsibility for watching the person in the water and keep them in sight while the boat maneuvers back to them
- Approach the person into the wind and waves. When alongside, put the engine in neutral and throw them a Type IV PFD with a line attached or extend an oar or boat hook.

SAFETY EQUIPMENT

Personal Flotation Devices (PFDs)

United States Coast Guard approved wearable personal flotation devices of Type I, II, or III must be onboard your Glastron Boat. The PFDs must be of a suitable size for each person aboard and shall be in serviceable condition and readily accessible.

⚠ WARNING

WARNING: It is the owner's responsibility to supply an approved Coast Guard fire extinguisher and all other required or recommended safety equipment. Consult your Coast Guard, state and local regulations to insure your boat has all required safety equipment onboard. Additional equipment may be recommended for your safety and that of your passengers. Make yourself aware of its availability and use. Make sure that your boat is operated by qualified drivers only.

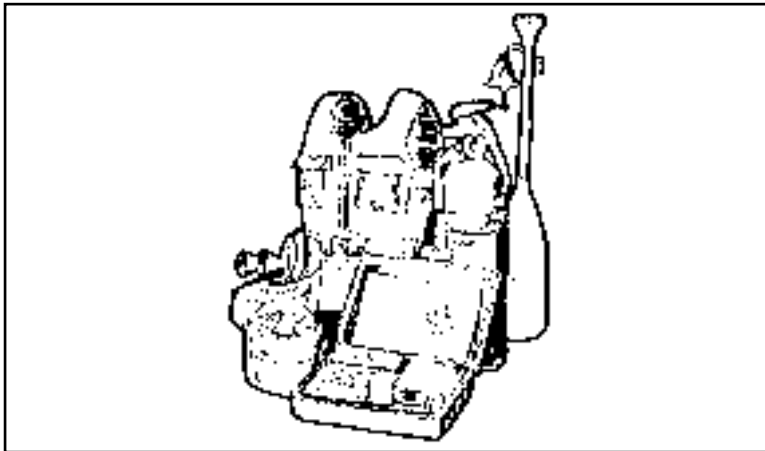

PFD TYPE I, WEARABLE

This PFD has the greatest required buoyancy. Its design allows for turning most unconscious persons in the water from face down position to a vertical or slightly backward position. Type I is most effective for all waters, especially offshore when rescue may be delayed.

Type I



PFD TYPE II, WEARABLE

Type II turns its wearer the same as Type I, but the turning action is not as pronounced as the Type I. The Type II will not turn as many persons under the same conditions as a Type I.

Type II

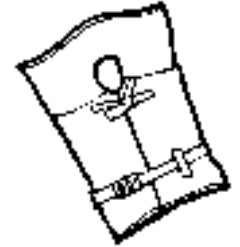

PFD TYPE III, WEARABLE

Type III allows the wearers to place themselves in a vertical or slightly backward position. Type III has the same buoyancy as a Type II PFD. It has little or no turning ability.

Type III



PFD TYPE IV, THROWABLE (ONE REQUIRED ON BOARD IN ADDITION TO THE ABOVE MENTIONED PFDs)

The PFD Type IV can be thrown to a person in the water, grasped and held by the user until rescued. The design does not allow for it to be worn. The most common Type IV PFDs are a buoyant cushion or ring buoy. The throwable Type IV PFD shall be immediately available for use, and in serviceable condition.

Type IV

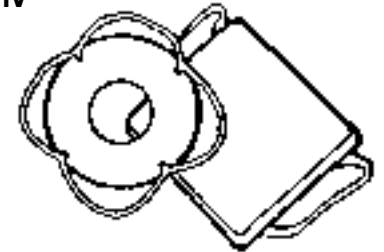

Fire Extinguishers

All Class 1 (16 to 26 feet) powerboats are required to carry one (1) B-I type hand portable fire extinguisher, if not equipped with a fixed fire extinguishing system in the engine compartment.

All Class 2 (up to 39.4 feet) powerboats are required to carry two (2) B-I type hand portable fire extinguisher, if not equipped with a fixed fire extinguishing system in the engine compartment. When equipped with a fixed fire extinguishing system, only one (1) B-I type hand portable fire extinguisher is required.

All hand portable fire extinguishers should be mounted in a readily accessible location, and away from the engine compartment. All persons aboard should know the location and proper operation of the fire extinguisher(s).

If your fire extinguisher has a charge indicator gauge, cold or hot weather may have an effect on the gauge reading. Consult the instruction manual supplied with the fire extinguisher to determine the accuracy of the gauge.

Visual Distress Signal Devices

Visual Distress Signal devices are required and may be of the pyrotechnic or non-pyrotechnic type. The regulation requires all recreational boats when used on coastal waters, which includes the Great Lakes, territorial seas and those waters directly connected to the Great Lakes and the territorial seas, up to a point where the waters are less than two miles wide, and the boats owned in the United States when operating on the high seas, to be equipped with visual distress signal devices.

Pyrotechnic and non-pyrotechnic equipment must be U.S. Coast Guard approved, in serviceable condition and stowed in a readily accessible location. Equipment provid-

ing a date for serviceable life, must be within the specified usage date as shown.

PYROTECHNIC EQUIPMENT

Pyrotechnic U.S. Coast Guard approved visual distress signals and associated equipment include:

- Red flares, hand held or aerial
- Orange smoke, hand held or floating
- Launchers for aerial red meteors or parachute flares

NON-PYROTECHNIC EQUIPMENT

- Orange distress flag
- S.O.S. Electric distress light

No single signaling device is flawless under all conditions for all purposes. Consideration should be given to possessing various types of equipment. Careful selection and proper stowage of the equipment is very **IMPORTANT** if young children are frequently aboard.

Sound Signaling Device

All Class 1 (16 to 26 feet) powerboats are required to carry a hand, mouth or power operated horn or whistle. It must produce a blast of two-second duration and audible at a distance of at least one-half (1/2) mile.

All Class 2 (up to 39.4 feet) powerboats are required to carry a hand, mouth or power operated horn or whistle. It must produce a blast of two-second duration and audible at a distance of at least one (1) mile.

Navigation Lights

Boats operating between sunset and sunrise are required to display appropriate navigation lights. All Glastron models are equipped with USCG approved lighting.

ADDITIONAL RECOMMENDED EQUIPMENT

The following list (not an exhaustive list) indicates some additional recommended equipment which should be considered for safe enjoyable boating.

Tools

- Spark plug wrench
- Screw Drivers
- Pliers
- Adjustable wrench
- Hammer
- Jackknife
- Electrician's tape
- Lubricating oil

Spare Parts

- Extra Bulbs
- Extra fuses
- Extra drain plug
- Shearpin (if used)
- Spare Propeller
- Extra prop nut and washer
- Spark plugs
- Spare wire

Basic Gear

- Anchor and Line
- Tow line
- Mooring lines
- Dock Fenders
- First aid kit
- Foul weather gear
- Flashlight
- Oar or paddle
- Compass
- Distress signals
- Boat hook
- Charts or navigation maps

BOATING LAWS & REGULATIONS

Boat Registration

Federal and state laws require that every boat equipped with propulsion machinery of any type must be registered in the main state of usage. Registration numbers and validation stickers must be displayed on the boat according to regulations. The registration certificate must be carried onboard when the boat is in use.

Discharge of Oil

The Federal Water Pollution Control Act prohibits the discharge of oil or oily waste into or upon the navigable waters of the United States or the waters of the contiguous zone if such discharge causes a film or sheen upon or a discoloration of the surface of the water or causes a sludge or emulsion beneath the surface of the water. Violators are subject to a penalty of \$5,000.

Disposal of Plastics & Other Garbage

Plastic refuse dumped in the water can kill fish and marine wildlife, and can foul vessel propellers and cooling water intakes. Other forms of waterborne garbage can litter our beaches and make people sick. U.S. Coast Guard regulations completely prohibit the dumping of plastic refuse or other garbage mixed with plastic into the water anywhere, and restrict the dumping of other forms of garbage within specified distances from shore.

ILLEGAL TO DUMP

INSIDE 3 MILES

(and in U.S. Lakes, Rivers, Bays and Sounds)

- **PLASTIC**
- **DUNNAGE, LINING AND PACKING MATERIALS THAT FLOAT**
- **ANY GARBAGE EXCEPT DISHWATER/GRAYWATER/FRESH FISH PARTS**

3 TO 12 MILES

- **PLASTIC**
- **DUNNAGE, LINING AND PACKING MATERIALS THAT FLOAT**
- **ANY GARBAGE NOT GROUND TO LESS THAN ONE SQUARE INCH**

12 TO 25 MILES

- **PLASTIC**
- **DUNNAGE, LINING AND PACKING MATERIALS THAT FLOAT**

OUTSIDE 25 MILES

- **PLASTIC**

The U.S. Coast Guard has issued these regulations to implement Annex V of the International Convention for the Prevention of Pollution from Ships, 1973, commonly known as Annex V of the MARPOL (Marine Pollution) Treaty 73/78. They apply to all U.S. vessels wherever they operate (except waters under the exclusive jurisdiction of a State), and foreign vessels operating in U.S. waters out to and including the Exclusive Economic Zone (200 miles).

The regulations require U.S. recreational boaters, if your boat is 26 feet or more in length, to affix one or more USCG Trash Dumping Restrictions placards to your boat. The placard warns against the discharge of plastic and other forms of garbage within the navigable waters of the United States, and specify discharge restrictions beyond the territorial sea (the territorial sea generally ends 3 nautical miles from the seashore). In addition, the placard must contain the warning that a person who violates these requirements is liable to civil (\$25,000) and criminal (imprisonment) penalties . The placard also must note that State and local regulations may further restrict the disposal of garbage.

Operators shall display one or more placards in a prominent location and in sufficient numbers, so they can be observed and read by crew and passengers. These locations might include embarkation points, food service areas, galleys, garbage handling spaces, and common deck spaces frequented by crew and passengers. The placards may be purchased from local marinas, boat dealerships, and marine equipment suppliers.

IMPORTANT: It is illegal to discharge waste from your marine sanitary device into the water in most areas. It is your responsibility to be aware of and adhere to all local laws concerning waste discharge. Consult with the coast guard, local marina, or your Glastron dealer for additional information.

GLASTRON BOAT LOG

Purchase Dealership

Name _____ Sales Manager _____
Address _____ Phone _____
_____ Fax _____

Service Dealership

Name _____ Service Manager _____
Address _____ Phone _____
_____ Fax _____

General

Model Name _____ State of Registration _____
Hull Identification Number _____
Boat Name _____
Hull Color(s) _____
Length _____ Beam _____ Weight _____
Draft (Drive Down) _____ Draft (Drive Up) _____
Freeboard (Fore) _____ Freeboard (Aft) _____

Engine

Manufacturer _____ Model Name/Number _____
Oil Type/SAE _____ Quarts _____ Filter Type _____
Serial Number _____ Transom Plate Serial Number _____

Drive Unit

Serial Number _____

Fuel System

Tank Capacity _____ Filter Type _____

Fresh Water

Tank Capacity _____

Propeller

Manufacturer _____ Pitch _____

Model Number _____

Battery

Manufacturer _____

Model Number _____

Radio

Manufacturer _____ Type _____

Model Number _____

Serial Number _____

Key Numbers

Cabin _____

Glove Box _____

Ignition _____

Trolling Motor

Manufacturer _____ Model Number _____

Serial Number _____

Other Electronics

Manufacturer _____ Model Number _____

Serial Number _____

GLASTRON CRUISE LOG

The boat listed below should return by:
 _____ at the latest.
Date Time
 If it has not, please call the emergency numbers
 listed at the right.

Police _____
 Coast Guard _____
 Other Authority _____
 Personal _____

Trip Information

Departure Date/Time _____ Departure Location _____
 Return Date/Time _____ Return Location _____

Boat Description

Boat Name _____ Type _____
 Registration Number _____ Manufacturer _____
 Length _____
 Hull Color _____ Deck (Color) _____
 Cabin (Color) _____ Trim (Color) _____

 Other Physical Characteristics _____

Engine

Type _____ HP _____
 Fuel Type _____ Fuel Capacity _____

Safety & Emergency Equipment (YES/NO & NUMBER)

Life Jackets _____	Cushions _____	Distress Light _____
Flares _____	Smoke Signals _____	Flash Light _____
Mirror _____	Paddles _____	Anchor _____
Food _____	Water _____	Life Raft _____

Radio

Onboard (Yes/No) _____ Type _____

 Frequencies usually used or monitored _____

Passenger List (Use Another Sheet If Necessary)

Full Name _____	
Age/Sex _____	Phone Number _____
Complete Address _____	
Full Name _____	
Age/Sex _____	Phone Number _____
Complete Address _____	
Full Name _____	
Age/Sex _____	Phone Number _____
Complete Address _____	
Full Name _____	
Age/Sex _____	Phone Number _____
Complete Address _____	



ALWAYS FILL THIS SHEET OUT COMPLETELY – IN AN EMERGENCY ALL INFORMATION MAY BE HELPFUL



This section introduces information related to major systems and components that are or can be installed on your Glastron boat.

You will see equipment safety labels at various locations on your boat. Glastron Boats has displayed these labels to alert you to potentially hazardous situations. Please do your part by reading ALL safety labels. Understanding the information on these labels is of vital importance. Check with your dealer if you have any questions about the labels or if they are missing from your boat. These safety labels should be on your boat, although all labels may not be needed on all boat models, depending on standard and optional equipment.

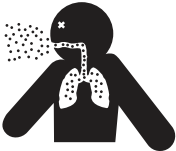

 **WARNING**

Carbon monoxide is produced by all gasoline engines and generator sets. To avoid brain damage or death from carbon monoxide, keep cockpit and cabin area well ventilated, and avoid blockage of exhaust outlets. Do not occupy swim platform or aft lounging area when engine or generator is running. Signs of exposure include nausea, dizziness and drowsiness. See owner's manual for more information.

GM1850101

 **WARNING**





Carbon monoxide is colorless, odorless and dangerous. All gasoline powered engines and generators exhaust carbon monoxide (CO). Direct or prolonged exposure will result in CO poisoning, which can be harmful or fatal. Signs of exposure to CO, that can easily be confused with sea sickness, include nausea, dizziness and drowsiness. To prevent excess exposure and reduce the possibility of accumulations of CO in the boat, the operator must ensure adequate forced air ventilation in the cockpit and all partially or fully enclosed areas, through use of hatches, windows, vents and forward facing canvas or plastic curtains to increase air movement through all areas. The following conditions tend to increase the accumulation of CO in the boat and require the operator's particular attention:

1. Operation at slow speeds or idle in the water.
2. Operation with a bow-high attitude.
3. Use of canvas tops, front, side and back curtains, and enclosures.
4. Contributing climate conditions, such as headwind, tailwind, or high humidity.
5. Operation of engines and/or generator in confined spaces, at dockside or alongside other boats.
6. Operation of poorly maintained engines and/or generator.
7. Any blockage of hull exhaust outlets.

SEE OWNER'S MANUAL FOR MORE INFORMATION.

GM1850201

 **WARNING**

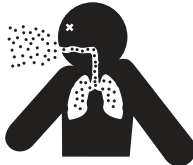

Exhaust fumes from engines contain carbon monoxide. To prevent fumes from entering cabin, keep door closed when engine or generator are running.

GM1850301

SAFETY LABELS

WARNING



To minimize shock and fire hazards:

- (1) Turn off the boat's shore connection switch before connecting or disconnecting shore cable.
- (2) Connect shore power cable at the boat first.
- (3) If polarity warning indicator is activated, immediately disconnect cable.
- (4) Disconnect shore power cable at shore outlet first.
- (5) Close shore power inlet cover tightly.

DO NOT ALTER SHORE POWER CONNECTORS

GM1850401

WARNING



Avoid serious injury or death from fire or explosion, resulting from leaking fuel. Inspect system for leaks at least once a year.

GM1850601

WARNING



Do not use ski tow fitting for lifting or parasailing. Fitting could pull out of deck resulting in serious injury or death.

GM1850801

WARNING



Rotating propeller can cause serious injury or death. Shut off motor when near persons in water.

GM1850901

WARNING

GASOLINE VAPORS CAN EXPLODE

BEFORE STARTING ENGINE

- *CHECK ENGINE COMPARTMENT FOR GASOLINE VAPORS.
- *OPERATE BLOWER FOR 4 MINUTES.

RUN BLOWER BELOW CRUISING SPEED

WARNING



Rotating propeller can cause serious injury or death. Never approach or use ladder when motor is running.

GM1851001

WARNING



Prevent falls overboard. Close, latch and stay inside gate(s) while underway.

GM1851101

WARNING



Prevent falls overboard. Do not occupy platform above trolling speed. Make sure latches are closed securely.

GM1851301

SAFETY LABELS

SYSTEMS

CAUTION

CAUTION: Glastron Boats recommends you **READ ALL** literature materials supplied with your boat prior to operating any of the systems and components. Any electrical accessories you would like to add to your boat should be installed by your dealer or a qualified electrician. Improper installation could result in damage to your boat's electrical system and/or cause a fire.

IMPORTANT: Operation, maintenance, and safety information is outlined by the manufacturer of most installed equipment. Properly operating and maintaining the equipment on your boat will help you to enjoy many years of **SAFE** boating.

12 Volt DC Electrical System

Your boat's 12 volt DC system obtains its power from a battery. The engine-drive alternator charges the battery while the engine is running. On boats so equipped, a voltmeter on the helm dash instrument panel indicates the charging level of the battery. Depending on the model of boat you own, the instrument panel also has fuses or circuit breakers (with indicator lights) which control the operation of your boat's DC equipment.

NOTE: If your boat has a bow panel, that panel has a battery charger switch. This switch charges only the battery for the trolling motor. It does not charge the battery for the DC system.

The negative terminal of the battery is connected to the grounding studs of the main engine. This type of negative ground system is the approved system for marine DC

electrical systems. If additional equipment is to be installed, it must be adaptable to the negative ground system. When installing additional equipment, ensure that each item's current supply is taken from the main DC distribution panel. All required additional circuit protection must also be added at the DC distribution panel.

NOTE: Power feeds for accessory equipment must **NOT** be taken from the voltmeter terminals.

A typical 12 Volt DC instrument panel schematic is shown in Figure 2.1. Figure 2.2 is a schematic for the bow panel on boats so equipped. Consult your Glastron dealer for additional DC power requirements on your Glastron model.

Electrical Wiring Diagram

The electrical schematics shown in Figures 2.1, 2.2, 2.3, and 2.4 are typical illustrations and are provided to explain how electric components on your boat are connected to the DC power source. These schematics are for general reference only and are not model specific.

See your dealer for all electrical system service work or to add any electrical equipment to your boat. Do not attempt to work on your boat's electrical system. All electrical system work should only be performed by a qualified marine technician.

Fuel System (Figure 2.5)

The internal fuel system onboard your Glastron boat is designed to meet or exceed federal requirements, at the time of manufacture, of the U.S. Coast Guard.

The fuel system has been factory inspected and pressure tested in accordance with regulations in effect at time of manufacture. Additionally, each fuel tank must pass rigid tests and inspections performed by the fuel tank manufacturer.

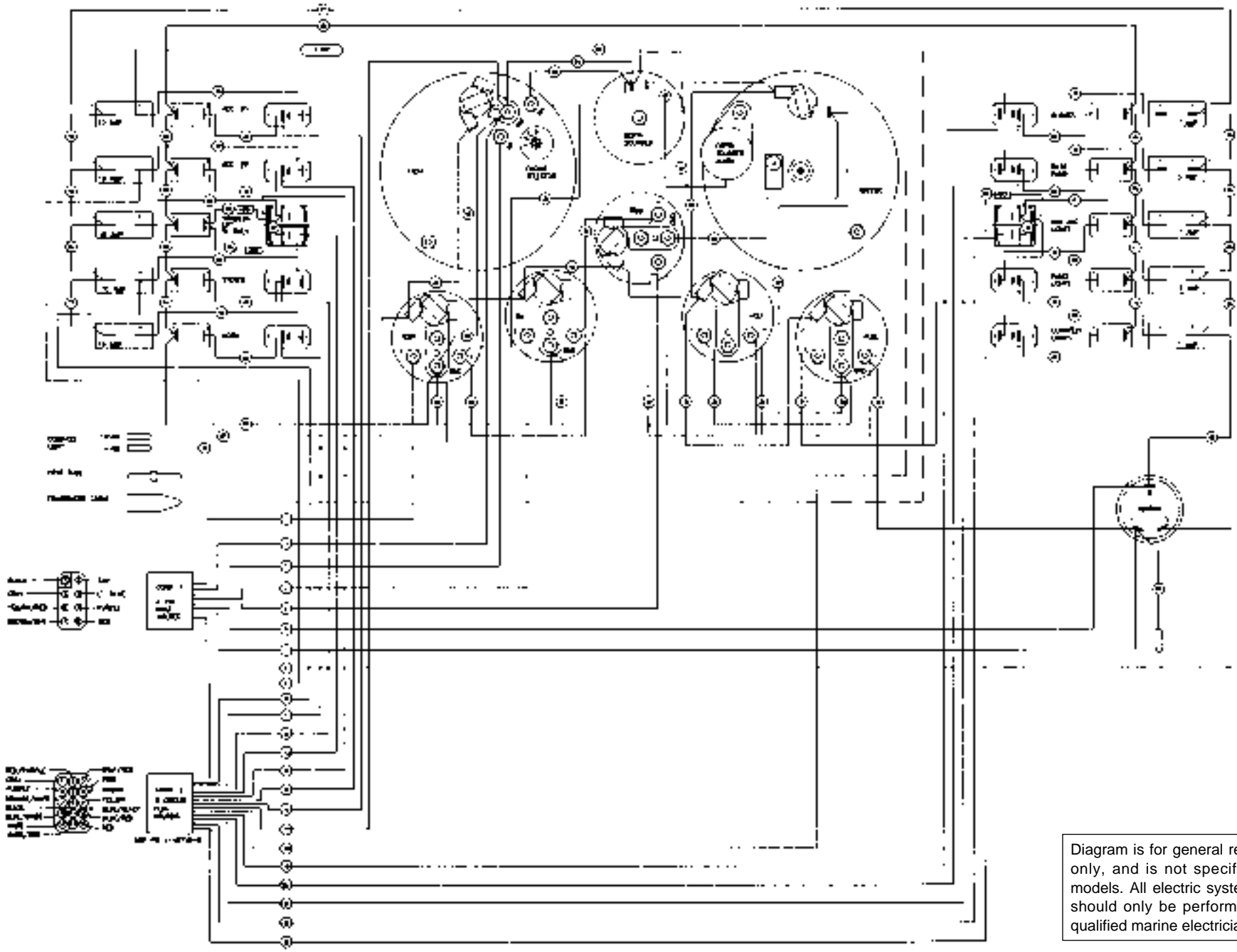

Diagram is for general reference only, and is not specific to all models. All electric system work should only be performed by a qualified marine electrician.

FIGURE 2.1 - TYPICAL INSTRUMENT PANEL SCHEMATIC

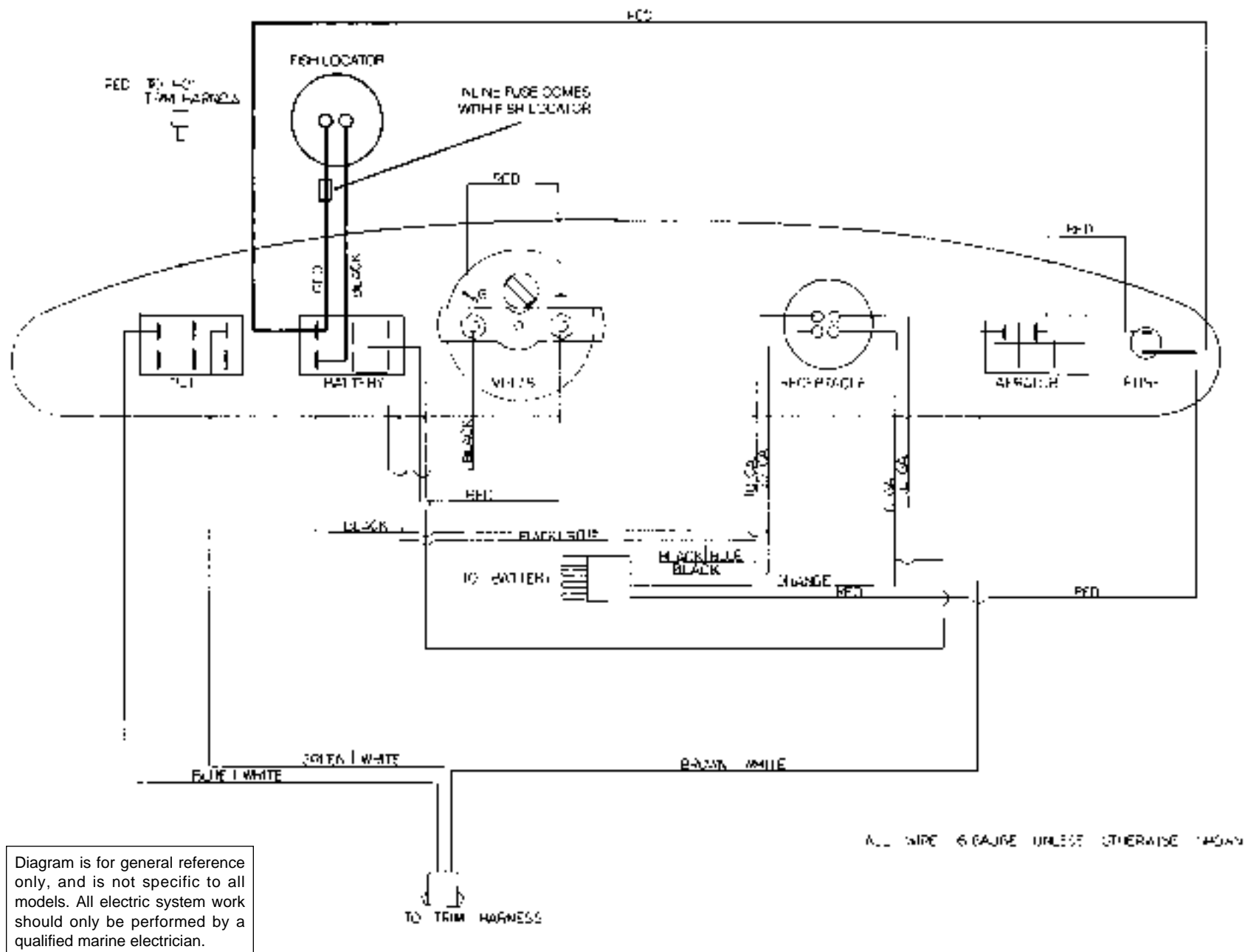

FIGURE 2.2 - SKI-FISH BOW PANEL

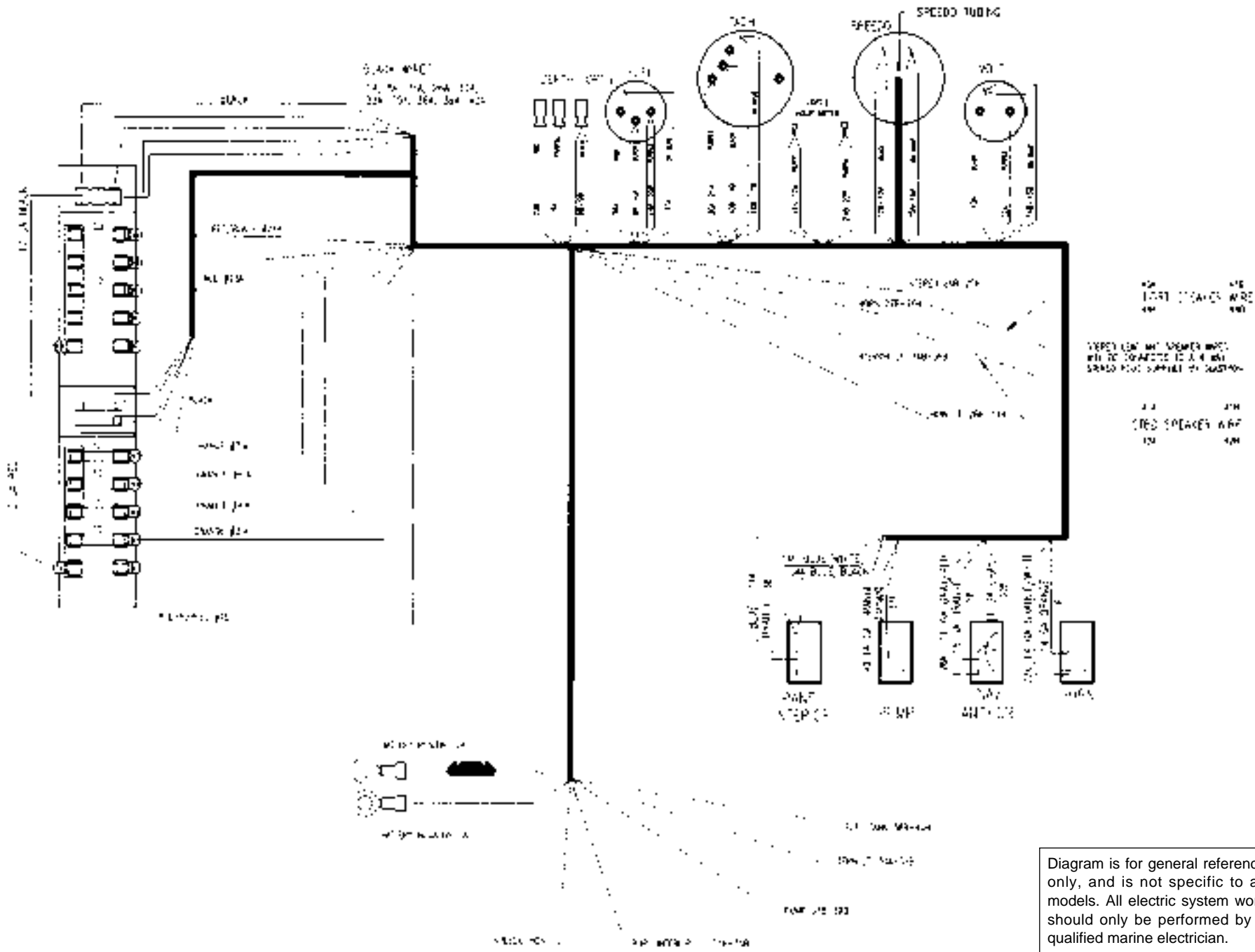

FIGURE 2.3 – OUTBOARD WIRING ASSEMBLY

Diagram is for general reference only, and is not specific to all models. All electric system work should only be performed by a qualified marine electrician.

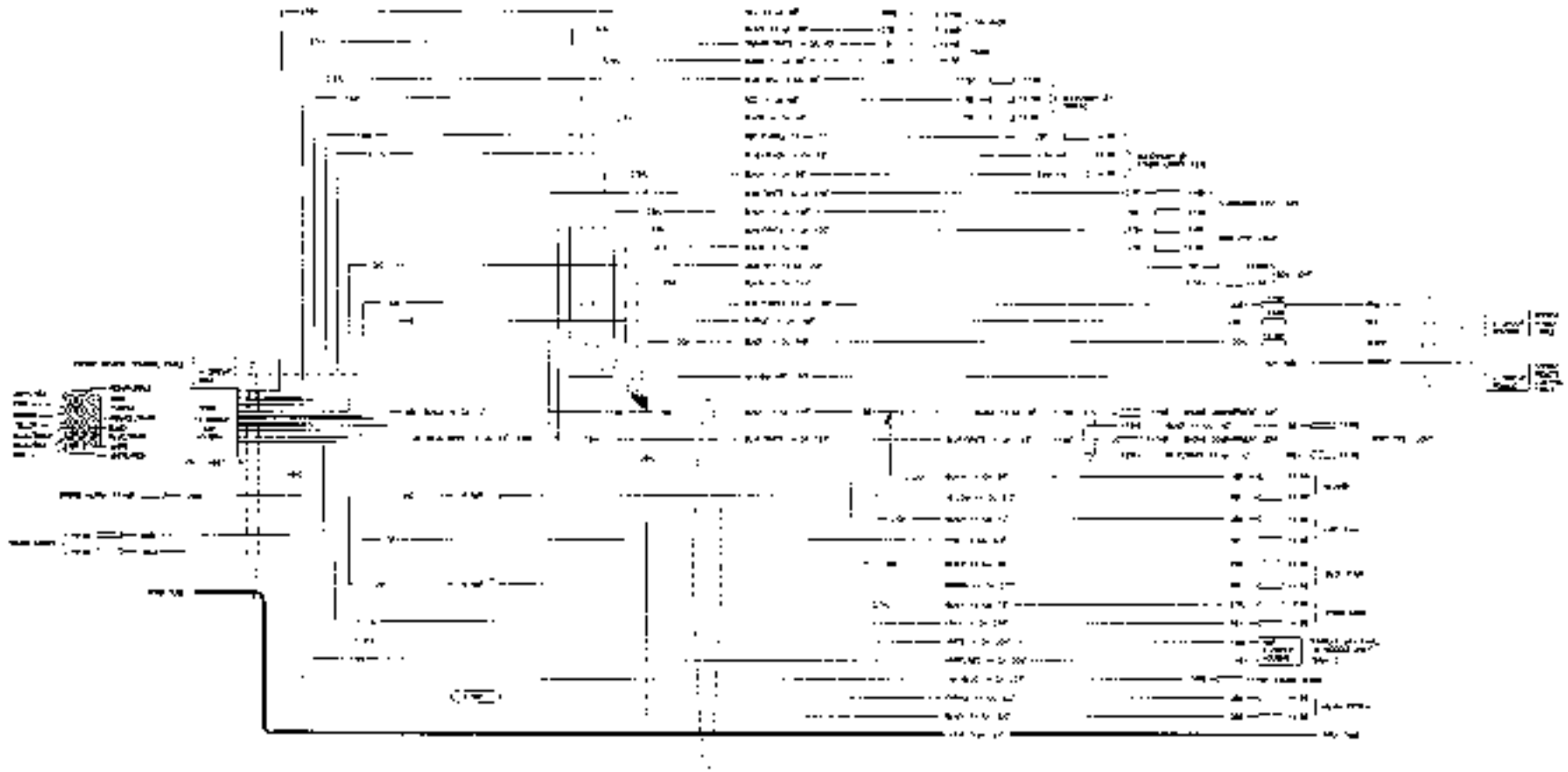

Diagram is for general reference only, and is not specific to all models. All electric system work should only be performed by a qualified marine electrician.

FIGURE 2.4 – TYPICAL ENGINE HARNESS SCHEMATIC

Prior to taking delivery of your Glastron boat, it is important that a full inspection be made of the entire fuel system by your Glastron dealer.

1. **Fuel Fill Plate** - All Glastron boats having an internal fuel tank are equipped with a fuel fill plate and are labeled GAS or DIESEL. Be sure to utilize the proper grade fuel as specified in your engine owner's manual.
2. **Fuel Vent** - The internal fuel tank is vented overboard or back into the fuel tank. While the tank is being filled, the air is expelled by the fuel and escapes through the fuel vent. When the fuel tank is almost FULL, fuel will be ejected from the fuel vent.
3. **Anti-Siphon Valve** - Engine fuel pick up lines on I/O boats are equipped with an anti-siphon valve where the line attaches to the internal fuel tank. The valve prevents gasoline from siphoning out of the fuel tank in the event of a fuel line separation. (This does not apply to O/B boats.)

4. **Fuel Filter** - The fuel filter supplied by engine manufacturers is installed on or near the engine. The filter should be cleaned frequently to maintain an adequate supply of clean, uncontaminated fuel to the engine.
5. **Fuel Tank** - The internal fuel tank is accessible through the engine compartment or deck access plates. The tank has a fuel vent line, fuel fill line, sending unit, and engine fuel pickup as shown in Figure 2.5.

Engine Exhaust System

The engine exhaust system removes harmful gas created by the engine during combustion. Inspect the system for leaks before each use of the boat. Make sure all hose clamps and connections are tight and there are no cracks in any exhaust system component that would allow carbon monoxide gases to escape.

Some models are equipped with exhaust diverters. This two position valve directs the engine exhaust either to through hull exhaust pipes for down through the propeller hub.

Directing the exhaust to the through hull pipes results in more engine power and a higher noise level. Do not operate your boat near shore while using the through hull option, due to the noise level.

Directing the exhaust to the propeller hub where it is released under water, results in quieter operation. Always use this option in marinas, near shore, or near anyone who may be bothered by an increased noise level. Always check local regulations regarding noise restrictions.

See your dealer for operational instructions on optional exhaust systems.

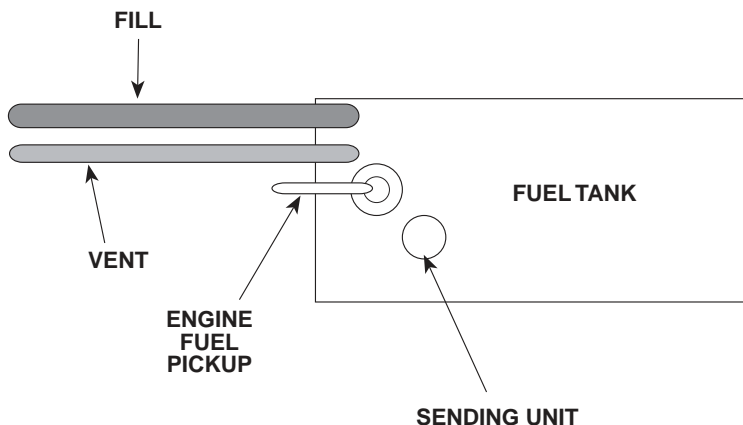

NOTE: Fill and Vent location varies by model. See dealer for location.

FIGURE 2.5 - FUEL SYSTEM

Fresh Water System (Optional)

The fresh water system provides water for drinking and bathing. A fresh water holding tank provides an onboard supply of fresh water. The holding tank is filled through a fill plate and is vented to allow air to enter and escape as water levels change.

The plumbing provides fresh water from the holding tank through a pressure pump to the optional hot water heater. Hot and cold fresh water is available to the sink and shower in the head compartment, and galley sink. A typical plumbing diagram is shown in Figure 2.6.

IMPORTANT: Fill tank only with fresh water. Using and refilling the tank often will help keep it a source of fresh and clean drinking water.

SANITIZING FRESH WATER SYSTEM

The fresh water system should be sanitized **before initial use**, after winter storage, or when system has not been used for extended periods of time.

CAUTION

CAUTION: Notify all persons aboard that the fresh water system is being sanitized. **Do Not** allow anyone to drink from the fresh water system during the sanitizing process.

NOTE: Fresh water tank must be empty before beginning sanitizing process. If necessary, empty the tank.

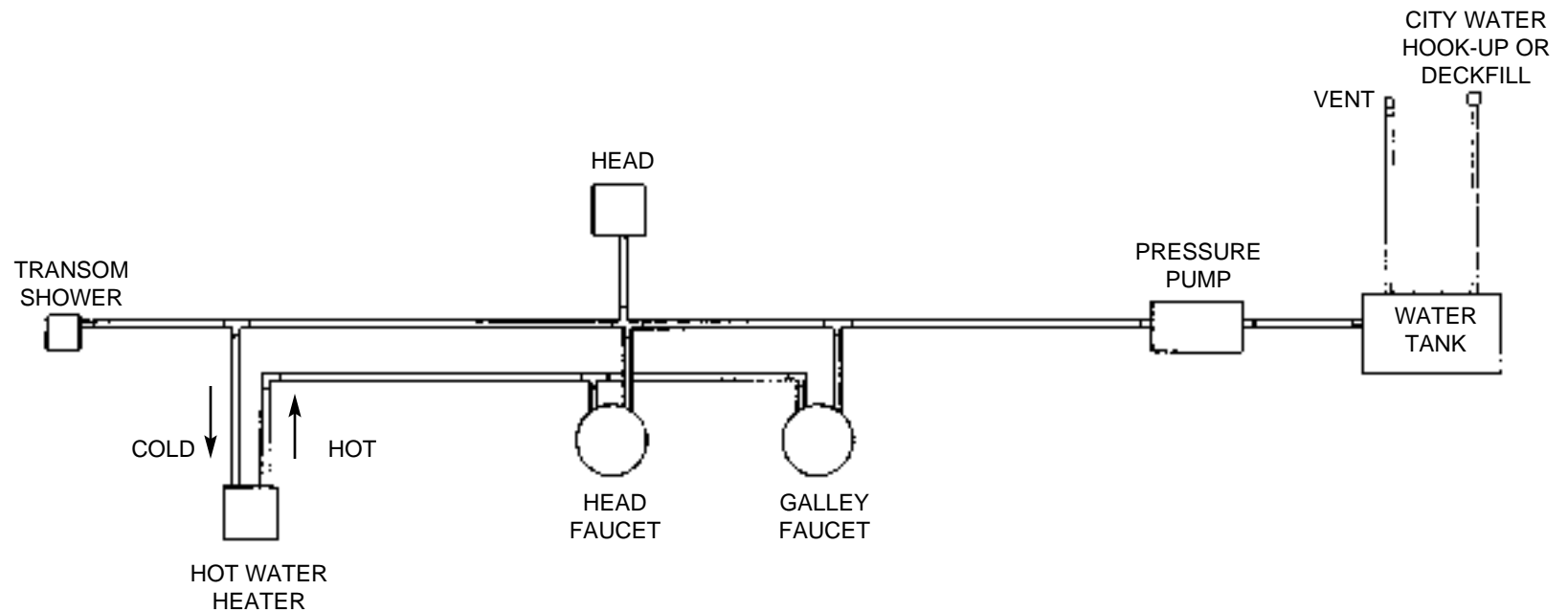

FIGURE 2.6 – TYPICAL PLUMBING DIAGRAM

1. In an appropriate size container, make a solution of 1-1/4 cups (10 oz.) of household bleach and 5 gallons (19 liters) of fresh water. For fresh water capacities greater than 5 gallons, increase quantity of bleach by 1/4 cup (2 oz.) per gallon (i.e., 10 gallons of fresh water, add 2-1/2 cups or 20 ounces of bleach).
2. Place solution into empty tank, then fill to capacity with fresh water.
3. Treated water solution should remain in tank for 3 to 4 hours.
4. Using manual pump, increase water pressure of system. Open faucet to bleed air from system.
5. Drain treated water solution from tank and lines.
6. Flush entire system with fresh water.

IMPORTANT: Thoroughly flush entire system with fresh water after each sanitizing process.

If excessive chlorine taste is present in fresh water system after sanitizing, perform the following:

1. Pour a solution of 1 quart (approx. 1 liter) of vinegar and 5 gallons (19 liters) of fresh water into tank.
2. Allow solution to stand in tank for several days.

⚠ CAUTION

CAUTION: Notify all persons aboard that the fresh water system is being treated. **Do Not** allow anyone to drink from the fresh water system during the treatment.

3. Drain entire system and flush with fresh water.

IMPORTANT: Thoroughly flush entire system with fresh water after treatment.

INITIAL START-UP

IMPORTANT: The fresh water system should be sanitized before initial use. See previous text information.

1. Partially fill the fresh water holding tank with water.
2. Using manual pump, increase water pressure of system. Open faucet to bleed air from system.
3. Close faucet when you see a steady flow of water.
4. Fill holding tank to capacity.

Protection Against Electrolysis

IMPORTANT: It is the boat owner's responsibility to periodically inspect and replace the sacrificial zinc anodes. Damage resulting from electrolytic corrosion is not covered by the Glastron Boats Warranty.

Sacrificial zinc anodes, installed by the dealer or the engine manufacturer, protect the hardware that is exposed to the water. Electrolysis attacks the softest or least "noble" metals first. Because zinc is a less "noble" metal, it will decompose before the more "noble" metals. Check these zinc anodes periodically and have them replaced as required. See your Glastron dealer for parts and service.

Zinc is also used to protect metal that is exposed to salt water. The salt causes a galvanic action that decomposes metals.

Marine Sanitation Device (MSD)

A marine sanitation device (MSD), or head, is available as optional equipment on some models. The MSD is a portable toilet, commonly referred to as a porta-potti, designed for simple disposal of waste by removing the holding tank and emptying its contents at an appropriate, approved location. Refer to the Porta-potti owner's manual for details.

IMPORTANT: It is illegal to discharge waste from your marine sanitary device into the water in most areas. It is your responsibility to be aware of and adhere to all local laws concerning waste discharge. Consult with the Coast Guard, local marina, or your Glastron dealer for additional information.

COMPONENTS

The single engine compartment shown in Figure 2.7 provides a means of locating components located within your boat. Your boat may be configured slightly differently depending upon the model and optional equipment installed.

⚠ WARNING

WARNING: When using electrical components, observe basic safety precautions to reduce the risk of fire, electrical shock, personal injury or damage to your boat and/or component.

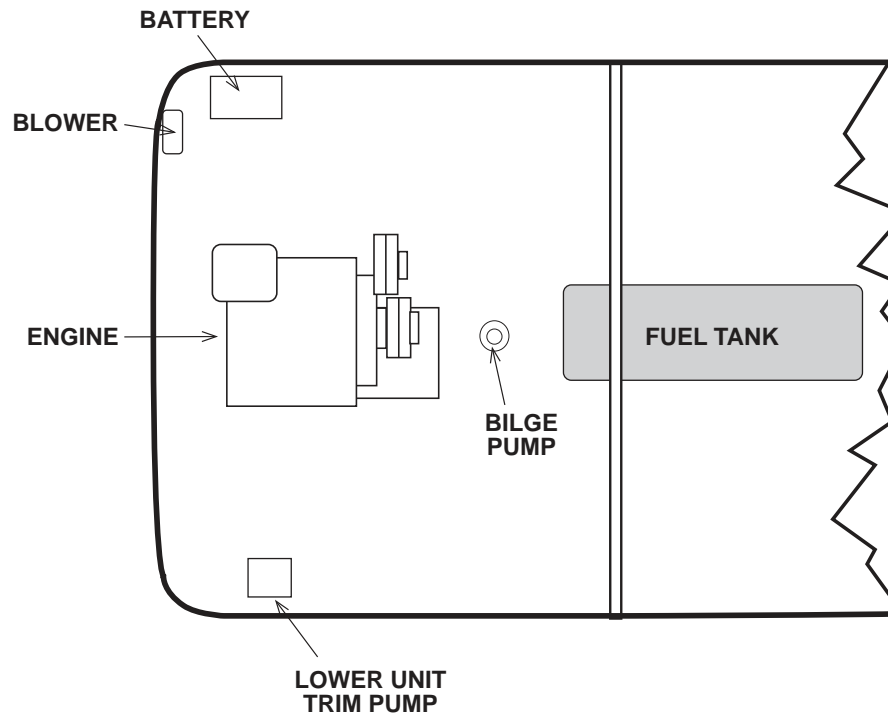

FIGURE 2.7 - TYPICAL I/O ENGINE COMPARTMENT

Battery

Your boat has a marine battery which supplies power to the DC electrical system. Marine batteries are completely sealed using an absorbent electrolyte principle to provide high reserve capacity plus cold cranking performance. When the engine is running the battery is charged automatically.

⚠ WARNING

WARNING: During charging, batteries produce gases which can explode, if ignited. Explosion can shatter battery. Acid can cause severe personal injury such as blindness. Keep flame, spark and smoking materials away from battery while charging. Charge battery in a well-ventilated area.

Batteries produce hydrogen and oxygen gases when being charged. These explosive gases escape through the vent/fill caps and may form an explosive atmosphere around the battery if ventilation is poor. This gas may remain around the battery for several hours after charging. Sparks or flames can ignite the gas and cause an explosion.

⚠ WARNING

WARNING: POISON! Batteries contain sulfuric acid which can cause severe burns. Avoid contact with skin, eyes or clothing. Wear goggles, rubber glove, and protective apron when working with a battery. In case of contact, flush with water at least 15 minutes. If swallowed, drink large quantities of water or milk. Follow with Milk of Magnesia, beaten egg or vegetable oil. Get medical attention immediately.

Ignition Interrupter with Lanyard

NOTE: This component is supplied by the engine manufacturer. Complete operating instructions can be found in the engine operator's manual.

The ignition interrupter switch is a safety device which automatically stops the engine if the operator falls from helm. A lanyard attached to the ignition interrupter must always be attached to a strong piece of clothing on the driver such as a belt loop. (An even better alternative would be to keep the lanyard attached to your life jacket as a reminder to you and your passengers to wear PFDs when the boat is underway.) If the driver leaves the helm station while the lanyard is attached to the driver, the lanyard will disengage the ignition interrupter and the engine will stop. For complete operating instructions refer to the owner's manual supplied with this switch (see Figure 2.8).

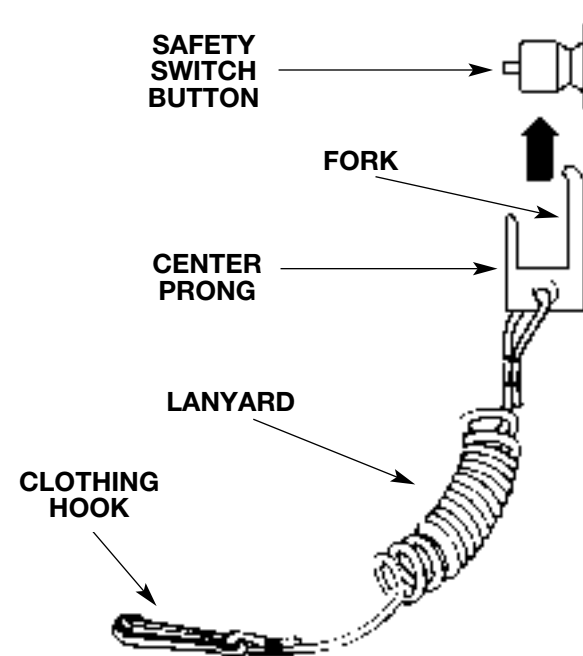

FIGURE 2.8 TYPICAL IGNITION INTERRUPTER WITH LANYARD

⚠ WARNING

WARNING: The ignition interrupter switch must never be removed or modified and must always be kept free from obstructions that could interfere with its operation.

At least once a month, check the switch to make sure it is working properly. With the engine running and the boat safely tied to a pier, grasp the lanyard and pull, to disengage the switch. If the engine does not stop, see your dealer for replacement of the switch before getting underway.

⚠ CAUTION

CAUTION: The lanyard stop switch should not be used as the normal engine shut-off.

Bilge Pump

⚠ WARNING

WARNING: The Federal Water Pollution Act prohibits the discharge of oil or oily waste into or upon the navigable waters and contiguous zone of the United States if such discharge causes a film or sheen upon, or discoloration of, the surface of the water, or causes a sludge or emulsion beneath the surface of the water. Violators are subject to a penalty of \$5000.

The bilge pump is used to remove water from the bilge. Most models are equipped with a manual bilge pump that operates only when you turn on the switch at the helm. The pump stops as soon as you turn the switch off. If you leave your boat in the water for extended periods of time,

be sure to check the bilge regularly for water accumulation. Excessive amounts of bilge water can damage equipment located in the engine compartment.

Some models are equipped with an automatic bilge pump. Rising water in the bilge activates a float switch to start the pump. When most of the water has been pumped out, the float switch automatically shuts the pump off. Automatic bilge pumps can also be turned on manually using the switch at the helm.

IMPORTANT: Electrically operated bilge pumps can fail. There is no substitute for checking the bilge frequently, especially during periods of heavy rain, high seas, or storm conditions.

If for some reason the pump fails to start, check the fuse and wiring connections. If the pump motor runs but no water is discharged, it may be clogged. Keep the area around the switch and the pump free of debris. If there is no visible debris clogging the pump or blocking the float switch and water is still not being removed, inspect the discharge hose for kinks or obstruction.

If oil or fuel is spilled in the bilge, do not run the pump. Keep the oil or fuel from spreading in the bilge and properly dispose of it on shore. Your dealer can help you select products you can use to soak up the oil or fuel and give you advice about methods of disposal.

Bilge Blower

Stern drive boats have a bilge blower. The bilge blower forces fumes out of the engine compartment area and circulates fresh air in through the deck vents. *The deck vents must be kept clean and open at all time.* The bilge blower must be running before and during engine start-up, and while boat is operating below cruising speed.

⚠ WARNING

WARNING: Never assume all explosive fumes have been removed from the engine compartment. If you detect any fuel odors, shut down the engine and electrical circuits, and immediately determine where the odor is developing.

Navigation Lights

Although activities are limited at night, night cruising can be pleasurable. Be especially careful of shallow waters and be on the watch for submerged debris, rocks, and other obstacles in the water. Your navigation lights are intended for collision avoidance only and are not intended to improve the operator's night vision.

Most models have one white (mast), one red (port), and one green (starboard) light. Check for proper operation before heading out. You should also learn to identify the running light combinations for other vessels. Glastron Boats recommends your participation in a boating safety course to further learn about navigation lights and safe boating practices.

The navigation lights are controlled at the helm by a three position rocker switch. This allows for selection of the mast (white) light ON when anchored or moored, or to have the mast (white), port (red) and starboard (green) lights all ON while underway and all lights are OFF in the OFF position.

Telescopic Stern Light (Optional)

The telescopic stern light serves two functions. In addition to serving as the stern white navigational light, it also can be used as a distress signal.

1. **Light Operation:** To activate light simply turn on boat's light switch. Light should first rise into position, then

illuminate. When the light switch is turned off, the light should immediately turn off and, after a 1.5 second computer check-period, the pole should be automatically retracted into its below deck position. The top of the lens should be flush with the top of the deck ring.

2. **Distress Signal Operation:** To operate the S.O.S. distress signal, turn on the light and allow it to fully extend and illuminate. Wait a minimum of ten seconds as the light runs a circuit check. Anytime thereafter, you may toggle the light switch (rapidly turning the light off, then immediately back on). The light should start to flash the Morse Code SOS. The light will continue flashing SOS until it is toggled again. The light should then light constantly. You must then pause briefly (five seconds) before turning the light off and having it retract below deck. If you fail to pause five seconds you will reactivate the SOS signal.

Depth Sounder (Optional)

The depth sounder can be used to determine how deep the water is underneath your boat. The depth sounder is connected to a transducer installed in the hull. After turning ON the unit, it automatically starts searching for the bottom. Once it's found, it will automatically adjust the sensitivity to keep the bottom depth displayed.

Specific operating instructions for the various depth sounder functions can be found in the manufacturer's literature supplied with your boat.

Many factors can affect the accuracy of the depth sounder. Do not rely on the depth sounder as your only navigational equipment.

Marine Stereo

The unit is a highly sensitive electronic tuning AM/FM stereo receiver with cassette tape player.

The system employs several electronic circuits especially designed for superb radio reception on both AM and FM bands. Built into the unit are the SNC (Stereo Noise Cut) for noise reduction on FM broadcasts and the HCC (High Cut Circuit) which automatically cuts hissing noise.

Your boat is equipped with waterproof marine stereo speakers. The number of speakers and their location will change per Glastron model. Some of the other features include AM/FM selector buttons, weather-band selector with channel selector, 7 band equalizer, head phone jack, CD (Compact Disc) input jack, automatic seek control, clock, battery back-up, memory, and mute control.

NOTE: The above listed features may vary on some marine stereo models. See the manufacturer's owner's manual for a complete list of features.

Automatic Fire Suppression System

Your boat may be equipped with an automatic fire suppression system in the engine compartment. This system uses a fire extinguishing agent. A heat-sensitive automatic nozzle releases the agent as a vapor, cutting off the supply of oxygen to the fire. The system's indicator light is illuminated when the system is fully charged. When the system is discharged, the indicator light will go out. The light is on the dash or a separate monitoring panel, depending on boat model.

▲WARNING

WARNING: If system discharges, immediately turn OFF engine, bilge blower(s), and electrical systems. Extinguish all smoking materials. Do not open engine compartment. Fresh air supplies oxygen to fire and fire may flash back through opening.

If the system discharges, do not open engine compartment for at least 15 minutes. Hot metals or fuel can also begin cooling during this time. Cautiously inspect compartment for cause of fire and damage to equipment. Have portable extinguishers readily available. *Do not breathe fire caused fumes or vapors.*

BOW PANEL

Some boats have an electrical panel in the bow. This panel has controls associated with the livewell aerator, the electric trolling motor, and the battery charger plug. Figure 2.2 is an electrical schematic of this panel.

Boats with a bow panel have two extra deep-cycle batteries in the stern which power the livewell aerator, the trolling motor, and the fish locator. These batteries are independent from the boat's direct current (DC) electrical system which is powered by your boat's starting battery. (Glastron does not supply these batteries.)

Livewell Aerator

An AERATOR ON/OFF toggle switch controls the operation of the livewell aerator. Toggling the switch to ON starts the livewell water pump and aerates the livewell. Toggling the switch OFF stops the pump. A fuse for the aerator pump is near the aerator toggle switch.

Trolling Motor Power Outlet

The factory has equipped your boat with a trolling motor plug and a battery charger plug. These plugs are designed to be used with the trolling motor outlet on the bow panel.

Glastron Boats recommends that you have your dealer install the trolling motor and battery charger plugs. To avoid damage to your boat or its equipment, and to pre-

vent personal injury, it is very important that only a qualified marine electrician install the plugs.

Voltmeter

The **voltmeter** indicates the charge remaining in the battery or batteries selected at the BATTERY selector switch. If the switch is in the #1 position, it indicates the charge remaining in Battery 1. In the #2 position, it reads the combined charge available from both batteries.

To charge the batteries, plug a 12/24 volt battery charger into the charge plug on the panel. Glastron recommends using a charger with a maximum rating not to exceed 40 amps.

IMPORTANT: When you charge the batteries, do not connect the charger clips directly to the battery posts. Have your Glastron dealer install the adapter plug directly on the battery charger cables. Refer to the Trolling Motor section for more detailed information about battery charging

Engine Tilt Control

The **TILT** switch has two positions: UP or DOWN. You can trim the main engine (outboard or inboard/outboard with stern drive) up from the bow of the boat by toggling the switch to the UP position. Operating your boat in shallow water will require trimming the engine up. When you are using the trolling motor, your boat will be easier to steer with the engine raised. You can lower the engine from the bow panel by toggling the switch to the down position.

TROLLING MOTOR

Some models have an electric trolling motor as standard equipment. This motor, which mounts on the bow of your boat, is powered by two deep-cycle marine batteries in the stern. The motor plugs into a receptacle on the bow panel.

The motor has an ON/OFF switch which activates the motor. A variable speed control allows you to adjust motor operating speed. The motor also has a forward/reverse switch to control the direction of travel.

Charging the motor's batteries slowly and frequently keeps them in top operating condition. A heavy, quick charge shortens battery life as does allowing batteries to sit after use without recharging them. The bow panel has a plug-in receptacle and a toggle switch for charging both batteries at the same time.



WARNING: During charging, batteries produce gases which can explode, if ignited. Explosion can shatter a battery. Acid can cause severe personal injury such as blindness. Keep flame, spark and smoking materials away from battery while charging. Charge battery in a well-ventilated area.

Batteries produce hydrogen and oxygen gases when the batteries are being charged. These explosive gases escape through the vent/fill caps and may form an explosive atmosphere around the battery if ventilation is poor. This gas may remain around the battery for several hours after charging. Sparks or flames can ignite the gas and cause an explosion.

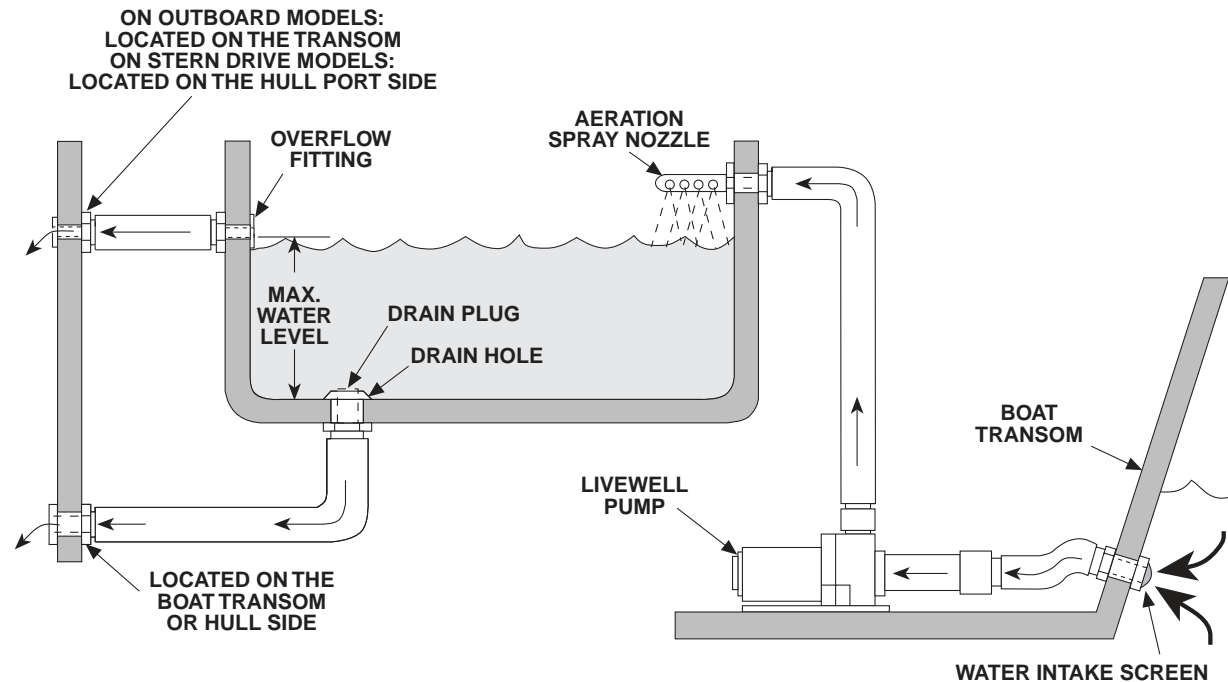

FIGURE 2.9 MANUAL LIVEWELL

⚠ WARNING

WARNING: POISON! Batteries contain sulfuric acid which can cause severe burns. Avoid contact with skin, eyes or clothing. In case of contact, flush with water at least 15 minutes. If swallowed, drink large quantities of water or milk. Follow with Milk of Magnesia, beaten egg or vegetable oil. Get medical attention immediately.

LIVEWELL

An aerated livewell is included as standard equipment on some models. The primary function of the livewell is to provide the means for keeping your catch alive until your day of fishing ends. Figure 2.9 shows the livewell system on your Glastron boat.

The livewell system has a pump that draws water in through a screen on the hull fitting and pumps the water through an aeration spray nozzle into the livewell. The oxygen content of the water increases as the small jets of water streaming from the spray nozzle splash onto the surface of the water in the livewell. The additional oxygen helps keep fish in the livewell alive.

Water above the level of an overflow on the side of the livewell flows through a hose and out through a fitting on the side of the boat. Removing a drain plug in the bottom of the livewell drains water from the livewell through a fitting in the boat hull below the level of the bottom of the livewell.

To fill the livewell:

1. Be sure the plug is in place in the bottom livewell drain.

2. Toggle the AERATOR switch at the bow panel to ON. The livewell pump will start, and the livewell will fill with water up to the level of the overflow.
3. Toggle the switch OFF when the livewell is filled.

Operate the livewell aerator as needed to freshen and maintain the oxygen supply by aerating the water in the livewell.

To ensure that your livewell remains clean and the water in it remains fresh, empty the livewell after you have finished using it. To drain the livewell, remove the drain plug in the bottom. Because water will drain only to the water level outside your boat, drain the livewell after you remove your boat from the water. If you are leaving your boat in the water, insert the drain plug and bail the remaining water from the livewell.

IMPORTANT: If water in the livewell system freezes, hoses can break as the frozen water expands. Be sure to empty the livewell completely during freezing weather.

Do not operate the livewell pump if it is not pumping water. Operating the pump dry can overheat its water-cooled motor and damage the unit. If water does not come out of the aerator nozzle:

1. Check the livewell fuse on the bow panel. Replace the fuse if necessary.
2. Make sure the pump is not clogged. If the pump or thru-hull fitting is clogged, you may be able to clear the obstruction by forcing water back through the pump. Using a garden hose, direct water flow into the pump outlet until water flows freely from the thru-hull inlet.
3. Make sure current is reaching the pump. Check and tighten connections. Make sure wires are not broken.

If you still have problems with the pump, contact your Glastron dealer.

ADDITIONAL SAFETY INFORMATION (SKI'N FISH MODELS)

1. Before using the ski tow bar make sure that it is securely fastened to the boat.
2. To prevent outboard motor damage when using the ski tow bar, make sure that the ski rope does not come in contact with the outboard motor.
3. When using the ski tow bar, all passengers must stay clear of the ski rope.
4. Only use the fishing seats (mounted in the bow or cockpit) if the boat is at a no wake speed or stopped.

ADDITIONAL INFORMATION FOR CRUISER MODELS

This section contains additional information concerning major systems and components that are or can be installed on your Glastron Sport Cruiser.

12 Volt DC Electrical System

Your boat's 12 Volt DC system obtains its power from a battery. The battery is charged through the engine-driven alternator and/or an AC battery charger. The voltmeter on the helm dash instrument panel indicates the charging level of the battery. Power from the battery is supplied through either a battery isolator or a dual battery switch. It is then routed to the instrument panel and DC distribution panel located in the galley. The DC circuit breakers on the instrument panel and DC distribution panel have indicator lights and operate all 12 volt equipment onboard.

The negative terminal of the battery is connected to the grounding studs of the main engine and generator. This type of negative ground system is the approved system for marine DC electrical systems. If additional equipment is to be installed, it must be adaptable to the negative ground system. When installing additional equipment, ensure that each item's current supply is taken from the main DC distribution panel. All required additional circuit protection must also be added at the DC distribution panel.

NOTE: Power feeds for accessory equipment must NOT be taken from the voltmeter terminals.

A typical Cruiser 12 Volt DC cabin schematic is shown in Figure 2.10. Consult your Glastron dealer for additional DC power requirements on your Glastron model.

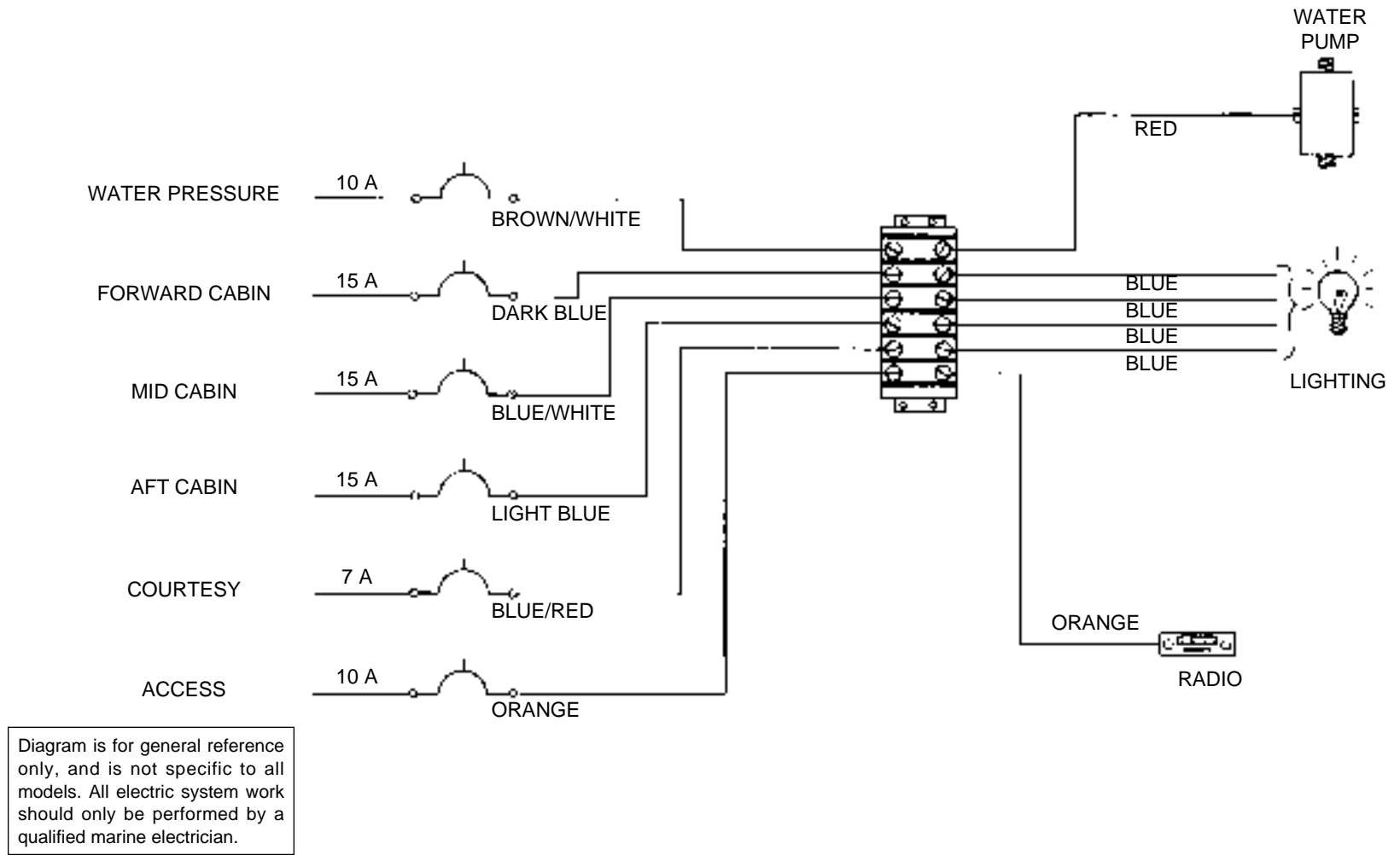

FIGURE 2.10 - TYPICAL CRUISER 12 VOLT DC CABIN SCHEMATIC

110 Volt AC Electrical System

The AC electrical system operates from a dockside shore power (30 amp 110 volt, 60 cycle). The dockside system uses three wire, color-coded circuitry. The black, or hot wire, is the ungrounded current carrying conductor. The white, or neutral wire, is the grounded current carrying conductor. The bare copper, or green wire, referred to as the “equipment ground,” is a grounded conductor, and under normal conditions is not a current carrying wire. The neutral wires are connected together at a buss bar. The equipment grounds are similarly connected together at another buss bar. Each hot wire is connected to, and protected by, a circuit breaker in the main distribution panel located in the cabin.

The main distribution panel houses the system circuit breakers. The dockside system has a MAIN circuit breaker which protects the overall distribution network. The MAIN breaker protects both the hot and neutral input leads. The MAIN breaker will also trip if reverse polarity should occur. This breaker is very sensitive. The resulting power surge which occurs when connecting into the shore power cord may cause the MAIN breaker to trip.

To avoid this power surge, turn OFF all MAIN breakers before plugging into the shore power cord. Securely connect the power inlet of the boat and the shore power receptacle. If the connection is broken and later re-secured, the MAIN breaker will trip. Connections must be secure for uninterrupted dockside service.

Appropriately labeled breakers control actuation of the optional electric stove and optional electric hot water heater. The electric stove also has heat controls governing the burner elements

All AC receptacles can be used for 120 volt household appliances.

CAUTION

CAUTION: Do Not overload the receptacle circuits. Most receptacle circuits are capable of handling 15 amps (amperes).

The following list of equipment specifies the required electrical current to operate each item:

<u>Item</u>	<u>Electrical Load</u>
Battery Charger	Up to 800 watts (7.3 amps)
Coffee Maker	550 to 700 watts (6.3 amps)
Electric Blanket	50 to 200 watts (2 amps)
Electric Drill	See drill motor load plate
Frying Pan	1350 watts (12.3 amps)
Lights	Wattage as marked on bulb
Space Heater	1500 watts (13.7 amps)
Television	1500 watts (10.5 amps)
Vacuum Cleaner	See vacuum motor load plate

The power requirement is usually specified on the electrical equipment. The above listed items are only an approximation of the electrical current usage normally experienced. Monitor the voltmeter when using electrical equipment. Amperage draw must not exceed 30 amps.

Figures 2.11 and 2.12 are examples of 110 Volt AC Panel Wiring Schematics. Consult with your dealer for specific schematic information for your boat.

The electrical schematics reflect how your boat's AC wiring harness and DC wiring harness are connected to standard and optional electrical components.

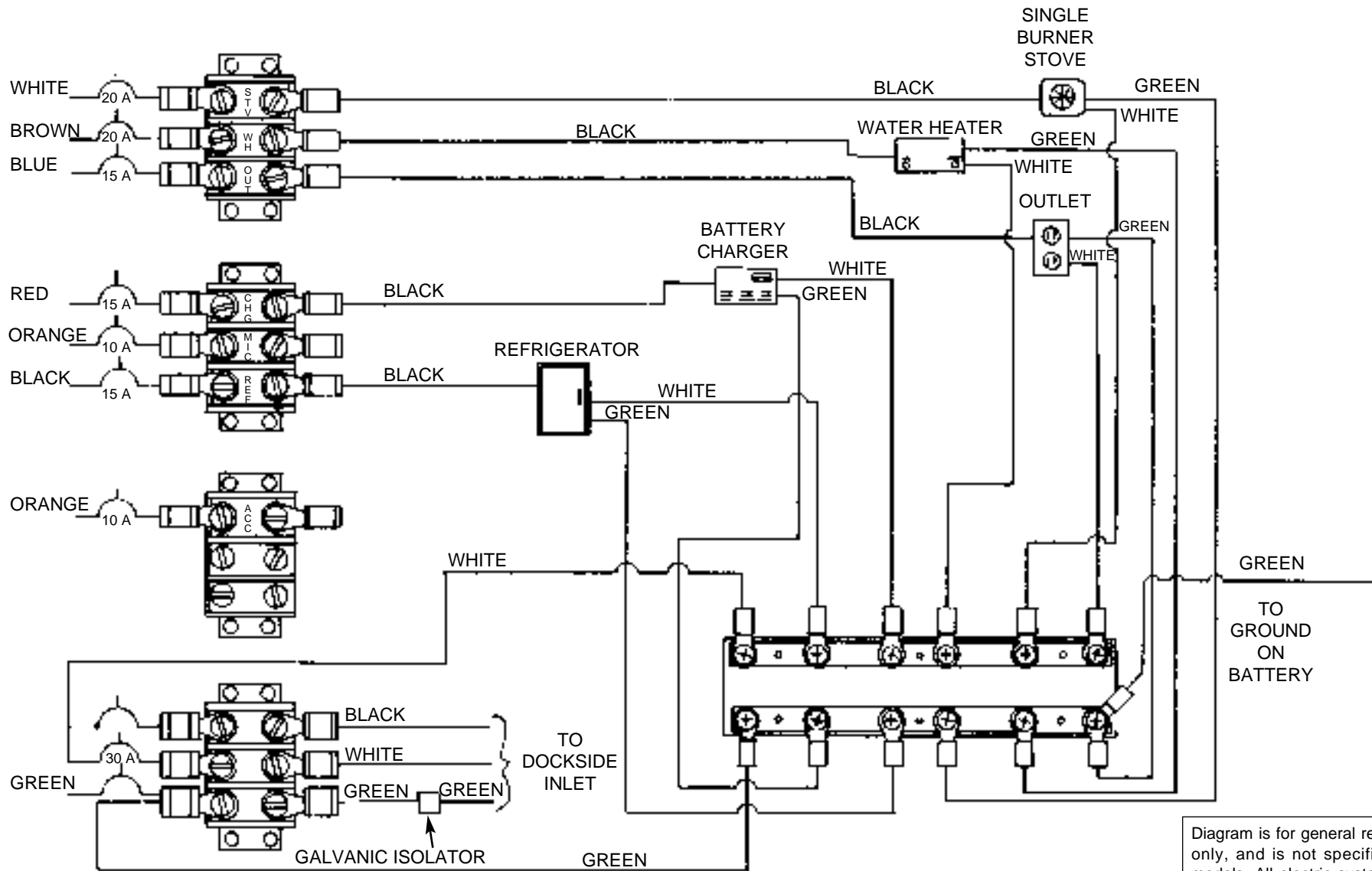

Diagram is for general reference only, and is not specific to all models. All electric system work should only be performed by a qualified marine electrician.

FIGURE 2.12 - TYPICAL 110 VOLT AC PANEL WIRING DIAGRAM

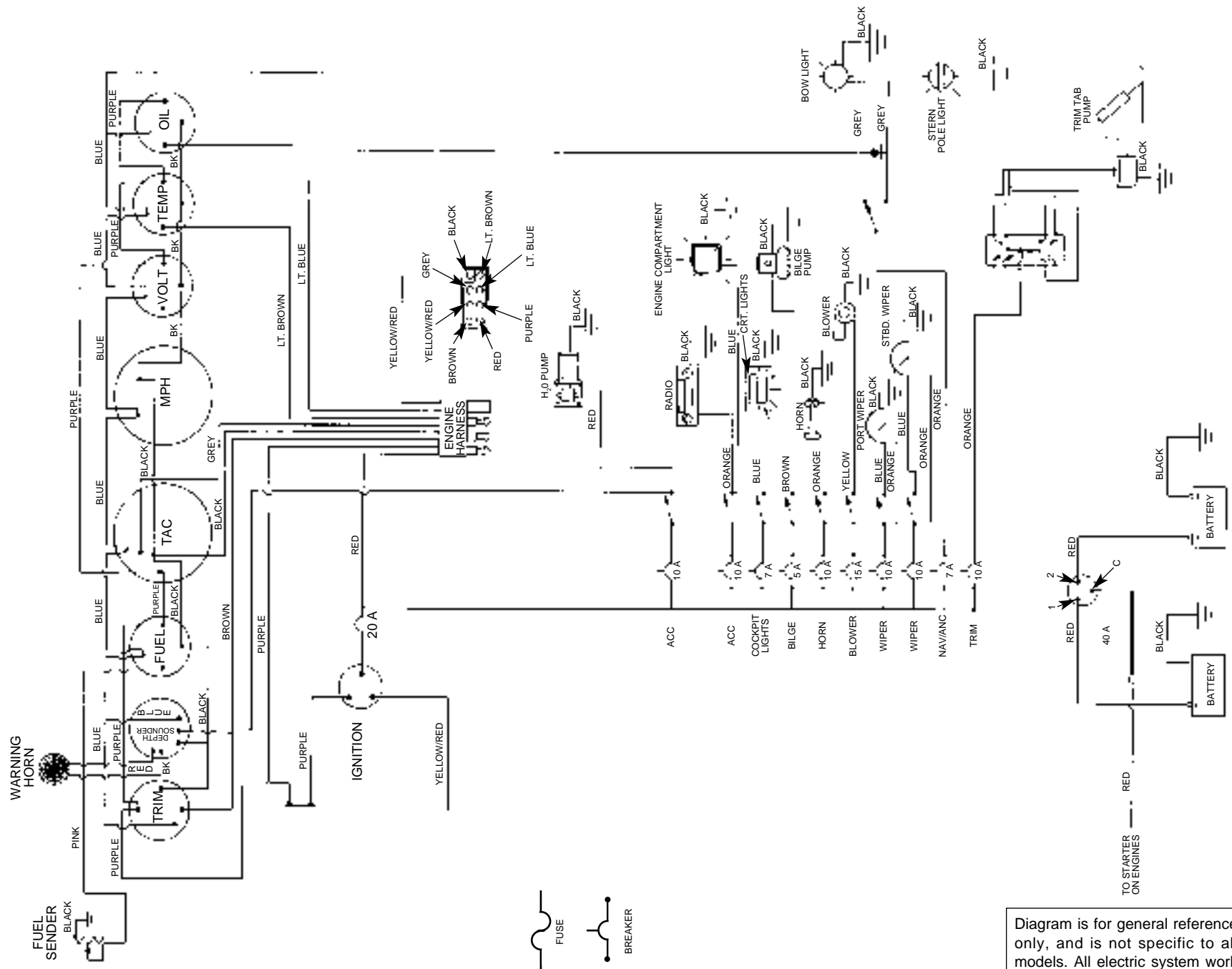

FIGURE 2.13 – TYPICAL CRUISER ENGINE 12 VOLT DC SCHEMATIC

Diagram is for general reference only, and is not specific to all models. All electric system work should only be performed by a qualified marine electrician.

Ground-Fault Circuit Interrupt (GFCI)

The GFCI is a device that gives added personal protection against electric shock or loss of life. The GFCI outlet on your boat is located in the galley. It is equipped with a test and reset switch in the middle of the face plate. If there is a difference of more than 5 milliamperes, a safety switch trips in the GFCI and interrupts the circuit. This protects the person who is operating the electrical equipment from serious electric shock. The GFCI will not eliminate the feeling of an electric shock. However, it does open the circuit quickly enough to prevent injury to a person of normal health. Thus, a GFCI provides protection against dangerous currents that will not overload 15- or 20-ampere circuit breakers. The GFCI protects all 110 volt outlet(s).

When a circuit breaker is tripped by the GFCI, you must push the RESET button. The GFCI outlet should be checked periodically by pushing the TEST button. Pushing the TEST button will cut power to the 110 volt outlets.

Shore Power

⚠ CAUTION

CAUTION: Never operate the shore power system at less than 105 volts.

Shore power is connected through an outside receptacle. A ten gauge, three wire, shore power cord is provided with dockside wiring. The shore power cord has 30 amp twist-lock type connectors, which are approved by the American Boat and Yacht Council. **Always connect the cord to the power inlet receptacle of the boat before making connection to the shore power source.**

⚠ CAUTION

CAUTION: Do Not use a two-wire adapter to connect to a three-wire system. This type adapter does not provide adequate grounding.

Some marinas are not equipped with approved twist-lock type receptacles. An adapter is supplied with your boat which converts the twist-lock shore plug to a three-wire grounded household type plug. Use only an approved adapter when this type connection is required.

⚠ DANGER

DANGER: Observe the polarity warning light and circuit breaker when using this system. Never override or bypass the system. Severe electrical shock hazard may be present which could cause death or injury.

All Glastron shore power systems are of the single male receptacle type. When not in use, a water resistant cover protects the outside receptacle on your boat.

City Water Hook-Up

⚠ CAUTION

CAUTION: Monitor water system during initial usage of *city water* hook-up. In this process, the boat is connected to an unlimited supply of water. Never leave boat unattended while using *city water* hook-up. Any major leak or break in the system will allow abnormal bilge water accumulation which in turn could cause sinking or swamping of batteries and engine. Damage from swamping and/or submergence are not covered by the Glastron Warranty.

To conserve your fresh water tank supply, the fresh water system can be connected to *city water* at the receptacle on port side of the transom in cockpit. Due to the water entering the boat under pressure, it bypasses the tank, filter, and pump of the fresh water system on your boat.

Using *city water* hook-up does not replenish water supply in the tank. The tank can only be filled at the fresh water fill plate. When using a dockside hook-up, you must bleed all lines just as you would for the fresh water tank system.

IMPORTANT: Refer to initial start-up procedures explained in the fresh water system section.

Electrolysis

Electrolysis is the decomposition of compounds, such as metals, exposed to an electric current. This is a common occurrence for boat owners. When a shore power AC electrical system is connected to your boat, it is also connected to an earth ground circuit. The earth ground circuit “grounds” all onboard metal parts to the earth on shore. This circuit provides the protection against hazardous shocks, but unfortunately it also creates an electrolytic current which causes the decomposition of all submerged metal.

Galvanic Isolator

The galvanic isolator is a galvanic corrosion protection device. It is installed between the AC safety ground and DC bonding system as shown in Figure 2.11. Electrical currents produced by two dissimilar metals in an electrolytic solution is galvanic corrosion. Polluted and salt water are much better electrolytic solutions than clean, fresh water. The galvanic isolator will block the majority of low voltage currents and reduce the corrosive action on the zinc anodes.

Marine Sanitation Device (MSD)

The Marine Sanitation Device (MSD), or head, installed on your Glastron boat, is similar to your home toilet. There are three (3) MSD illustrations depicting the various head configurations which may be installed on your Glastron boat (See Figures 2.14 through 2.16). Some units incorporate a Y-Valve that must be selected on the valve based upon your choice of directing waste. All MSDs are equipped with an air vent and pump-out plate.

IMPORTANT: It is illegal to discharge waste from your marine sanitary device in most areas. It is your responsibility to be aware of and adhere to all local laws concerning waste discharge. Consult with the coast guard, local marina, or your Glastron dealer for additional information.

MARINE HEAD WITH PUMP-OUT (SEE FIGURE 2.14)

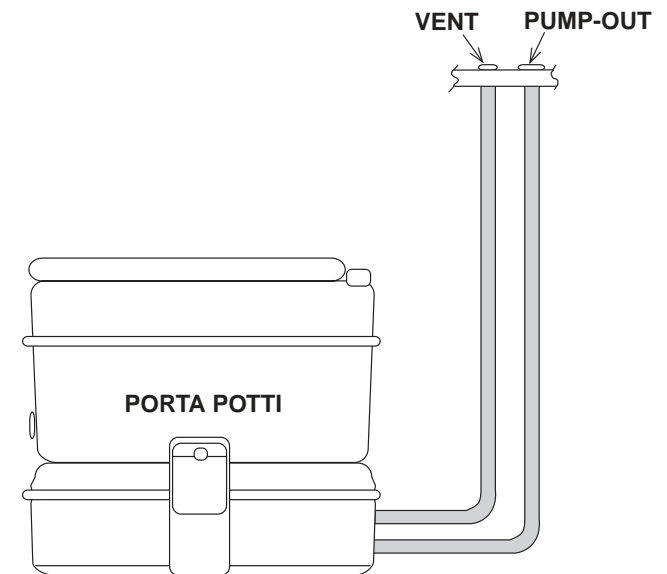

FIGURE 2.14 – MARINE HEAD WITH PUMP OUT

This portable toilet (porta potti) provides simple operation and convenient disposal of waste. (See Figure 2.14) The waste can be either transported off the boat by removing the holding tank, or can be pumped out at dockside.

CHINA HEAD TO HOLDING TANK (SEE FIGURE 2.15)

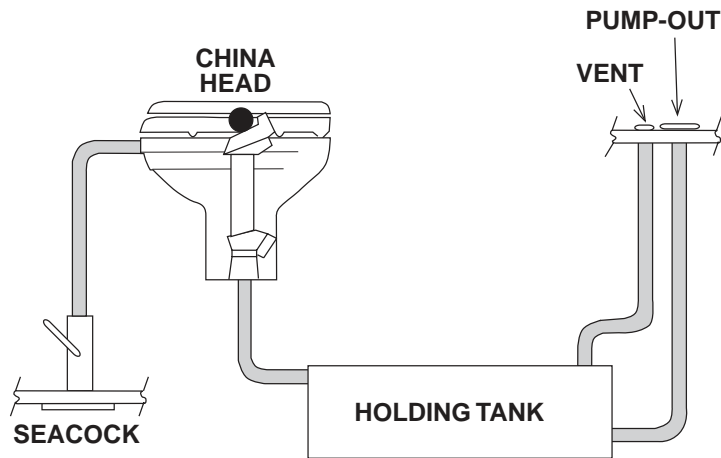

FIGURE 2.15 – CHINA HEAD TO HOLDING TANK

This system incorporates a china head.

⚠ WARNING

EXPLOSION HAZARD! Waste in holding tank can form methane, an explosive gas. Keep vent open and clear of obstructions. Keep fire and flame away when maintaining sanitary system.

This china head relies on sea water drawn through a sea-cock thru-hull fitting for flushing waste to the holding tank for dockside pump-out. The seacock must only be open when flushing the head and should be closed when not in use.

CHINA HEAD TO HOLDING TANK WITH MACERATOR TO OVERBOARD DISCHARGE (SEE FIGURE 2.16)

This china head version operates the same as the china head referenced in Figure 2.15 except waste is routed from the holding tank to the Y-Valve. Here the option exists to either direct waste to a macerator pump and discharge overboard via the thru-hull fitting, or route waste to the dockside pump-out through the Y-Valve from the holding tank. Overboard discharge of waste is prohibited in many areas. Check local laws before discharging waste overboard.

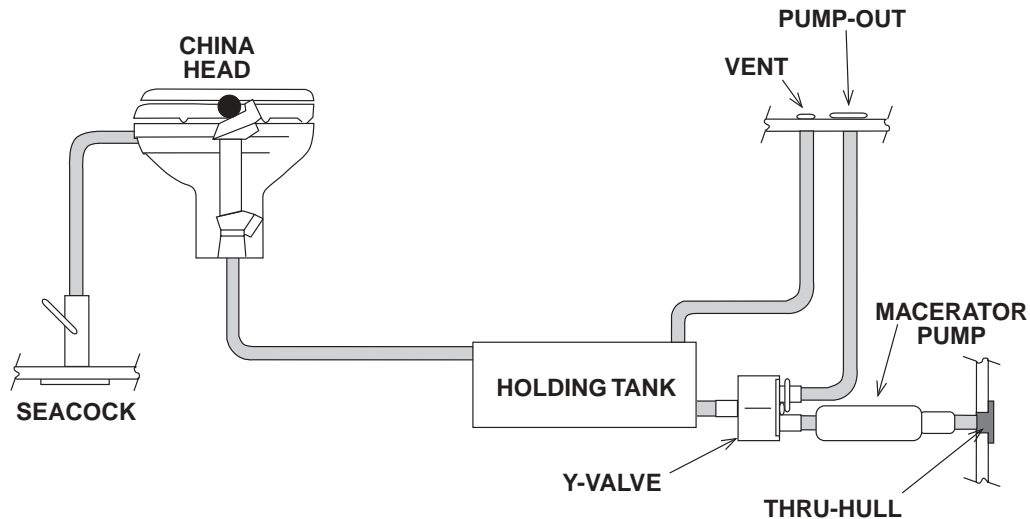

FIGURE 2.16 – CHINA HEAD TO HOLDING TANK WITH MACERATOR TO OVERBOARD DISCHARGE

COMPONENTS

The engine compartment (Figure 2.17) illustration provides a means of locating components located within your boat. Your boat may be configured slightly differently depending upon the model and optional equipment installed. Some of the components described may be optional equipment, or may not be available on particular boat models.

⚠ WARNING

WARNING: When using electrical components, observe basic safety precautions to reduce the risk of fire, electrical shock, personal injury or damage to your boat and/or component. To avoid explosion, do not connect or disconnect battery cables if gasoline fumes are present.

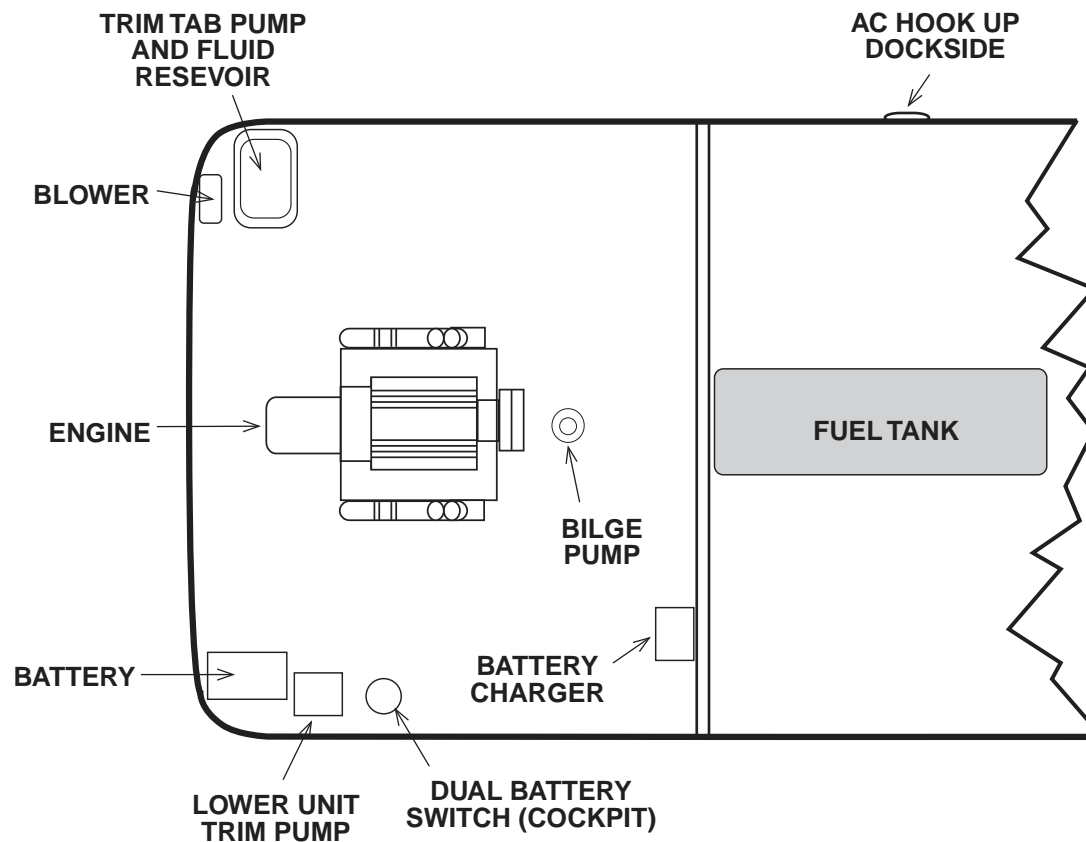

FIGURE 2.17 - TYPICAL ENGINE COMPARTMENT

Dual Battery Switch

The dual battery switch enables DC power to be used from one or two batteries. Power to the engine and all 12 volt electrical equipment, except the **automatic bilge pump and 12 volt refrigerator**, is controlled by the dual battery switch. The dual battery switch settings available are OFF, 1, 2, and ALL.

IMPORTANT: The dual battery switch should be in the OFF setting when not in use and especially while the boat is unattended. While in the OFF setting, only the **automatic bilge pump and 12 volt refrigerator** is supplied with DC power. All helm dash instrumentation is OFF.

The description and function for each of the settings is described here:

- **OFF** - All 12 volt power to boat is shut OFF, except for the **automatic bilge pump and 12 volt refrigerator**. Always turn dual battery switch to OFF setting when boat is unattended for extended periods.

CAUTION

CAUTION: Do Not turn dual battery switch to OFF setting while engine is running; alternator and wiring damage could occur.

- **1** - Will use battery #1 to power engine and all 12 volt equipment. Battery #2 is isolated and remains in reserve. Battery #1 is charged by the alternator.
- **2** - Will use battery #2. Except for automatic bilge pump, battery #1 is isolated and remains in reserve. Battery #2 is charged by the alternator.

- **ALL** - Batteries are connected in parallel. Both batteries are used by the engine and all 12 volt equipment, and charged by the alternator when the engine(s) is running.

Glastron recommends the use of only one (1) battery at a time. This is accomplished by using the number 1 or 2 setting. Avoid using the ALL setting. Only use the ALL setting when a single battery is not sufficient to start the engine(s).

NOTE: Rotating your battery usage will increase battery longevity.

Battery Charger

The battery charger will automatically maintain the battery, if the AC breaker panel switch is on and the system is plugged into the dockside power on shore. Abnormal conditions or loads may cause circuit breaker to trip. Circuit breaker can be reset with power applied.

Carbon Monoxide (CO) Monitor (Used with camper top option)

To activate the monitor, you must turn the battery switch ON to apply power. The CO monitor samples carbon monoxide concentration every 2-1/2 minutes. Once an alarm condition has been detected, the horn will be locked ON for the next 2-1/2 minutes at which time the next concentration will again be checked. At sample time, if the concentration is below the alarm threshold, the horn will be turned OFF. If the concentration is above the threshold, the horn will remain ON.

Automatic Bilge Pump

The automatic bilge pump with manual override removes water from the bilge area. If the pump motor runs but no water is discharged, it may be clogged. If there is no visible debris clogging the pump and water is still not being removed, inspect the discharge hose for kinks or obstruction.

⚠ WARNING

WARNING: The Federal Water Pollution Act prohibits the discharge of oil or oily waste into or upon the navigable waters and contiguous zone of the United States if such discharge causes a film or sheen upon, or discoloration of, the surface of the water, or causes a sludge or emulsion beneath the surface of the water. Violators are subject to a penalty of \$5000.

Water Pump & Filter

The water pump draws water from the fresh water tank. The water is then pressurized and circulated to the faucet, water heater, etc. The water pump filter prevents foreign matter from entering the pump reservoir and should be periodically inspected and cleaned.

Before servicing the system, turn the water system breaker OFF and release pressure on the system by opening all faucets. To clean the filter, remove screen and rinse with clean water. Replace filter and make sure the O-ring is seated properly when installing cover.

Hot Water Heater

The hot water heater circuit breaker (15 amp) is located on the main AC distribution panel. Located on the water heater is a check valve to prevent hot water from back washing into the cold water line, and a pressure relief valve to prevent damage to the heater from over pressure. The water heater thermostat is pre-set and is not adjustable.

⚠ CAUTION

CAUTION: The heating element inside the water heater will be damaged if 110 volt power is supplied to the water heater when there is an insufficient amount of water in the tank.

Transom Shower

The transom shower utilizes a pump to draw fresh water from the main fresh water systems water tank.

Refrigerator/Freezer

The refrigerator/freezer operates on either 110 volt AC or 12 volt DC power. A built-in relay automatically switches to the correct power. Keep the temperature control dial setting at the #3 position (#5 if storing frozen foods) when outside temperatures are between 70 to 90 degrees F. When using 12 volt DC power, run the engine occasionally to ensure your battery maintains an adequate charge. The master On/OFF switch for the refrigerator is located on the main AC panel for 110 volt operation.

Stove

⚠ WARNING

WARNING: Use marine stove alcohol only. Always provide adequate ventilation when using an alcohol flame.

Your boat is or can be equipped with either an alcohol or alcohol/electric stove. The fuel reservoir holds approximately one quart (.95 liter) of ethyl alcohol. The alcohol/electric stove uses either alcohol or 110V 30 amp electrical power. When operating the stove by using 110 volt power, the master switch on the main Ac panel must be in the ON position.

⚠ DANGER

DANGER: Follow instructions from stove manufacturer carefully when refueling; never refuel while unit is in operation.

Trim Tabs

If your boat is equipped with trim tabs you can use them to adjust the boat's trim to the optimum angle for load and water conditions. Trim tabs add lift to the boat's stern, thereby changing the boat's attitude (see Figure 2.18). This life can help the boat remain on plane at slower speeds than if no tabs were used.

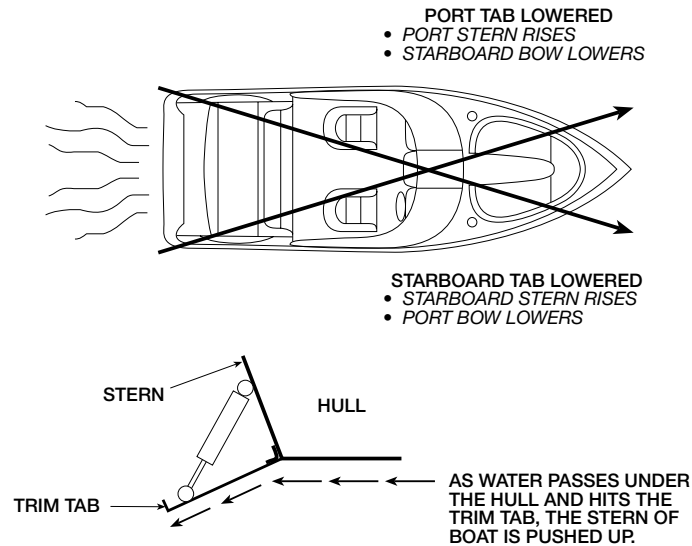

FIGURE 2.18 – TRIMMING WITH TRIM TABS

During one of your first boating expeditions, take the boat out onto open water and experiment with the trim tabs. After you get the boat on plane, set the tabs in various positions and note how the boat reacts. This will give you a feel for how the trim tabs work.

WARNING

WARNING: Loss of Steering Control! Do not lower the tabs all the way at high speeds. You may lose steering control. Lower tabs a little at a time. Observe effect on boat operation before lowering further.

Used independently, trim tabs can also compensate for seas, winds, or uneven loads.

Head Seas	Trim drives in more than usual. Lower tabs to keep bow down and go at a slower speed.
Following Seas	To prevent taking seawater over the bow, trim drives in and keep tabs up to keep bow up.
Listing due to Quartering Seas, Beam Wind, or Uneven Load	Use tabs independently to adjust for list. If listing to starboard, lower port tab. If listing to port, lower starboard tab.

Remember that all boats react very slowly to trim tabs. Often operators do not give trim tabs time to work. Press the trim tabs switches for only two seconds at a time and then allow some time for the boat to react. If the boat is still listing after a minute or two, press the trim tab switch again for a two-second interval.

IMPORTANT: Basic safety precautions should always be followed with the operation of trim tabs. Do not step on trim tabs. Injury may occur from slipping.

It is possible to extend the cylinder life expectancy on your trim tabs. To do this, keep the cylinders retracted while at dockside. Press both trim tab controls down until tabs reach their full up position.



Boat ownership carries with it certain responsibilities to yourself as well as your passengers and the general public. Safety, common sense operation, careful maintenance, and compliance with the law will not hamper your boating pleasure, but will make boating more enjoyable.

TRAILERING

Selection of a trailer for your Glastron boat is extremely important. Your trailer should be able to accommodate the weight of the boat, engine, and any other equipment that will normally be carried. Take the time to have your boat weighed while it is empty, and again when completely loaded including a full fuel tank. You will save a great deal of trouble by staying within the maximum load limits of the trailer.

Check the certification label on the frame of the trailer for the Gross Vehicle Weight Rating (GVWR). The total weight of your boat, engine, fuel, gear, and trailer should not exceed the GVWR. Your Glastron dealer can help you select an appropriate trailer for your boat.

For older trailers, proper adjustment of the side support pads is critical each time your boat is loaded. Newer trailers feature side supports that are self-adjusting. Periodically inspect your trailer to make sure the side supports are in adequate working condition.

IMPORTANT:The side supports should only be tight enough to keep the boat from leaning side to side. Any unnecessary pressure will damage the hull.

If your towing vehicle is equipped with a weight-distribution hitch, it must be capable of handling the GVWR. The weight on the trailer should be evenly distributed and can be checked by determining the tongue weight.

Tongue weight is measured as a percentage of the total weight of the loaded trailer on its tongue. Ideal tongue weight is not less than five percent (5%) and not more than ten percent (10%) of the GVWR. For example, if the weight of the loaded trailer is 3000 pounds, the weight on the tongue should be more than 150 pounds but less than 300 pounds. Excessive tongue weight will cause the front end of the towing vehicle to sway. Insufficient tongue weight will cause the trailer to sway or fishtail.

⚠ WARNING

WARNING:Improper trailer size and improper weight distribution can cause swaying and fishtailing that can result in extensive damage to the trailer, the boat, and the towing vehicle. Swaying and fishtailing are especially dangerous at higher speeds where they can become uncontrollable. Damage caused as a result of improper trailering is not covered under the Glastron Boats Warranty.

All trailers with a GVWR of 1500 pounds or greater are required to have brakes. Requirements may vary, so check with your Glastron dealer for additional information.

Trailer Guidelines

1. Be sure that the rollers or bunks displace a large amount of hull surface, and be sure the boat and equipment distribute evenly on the trailer.
2. Make sure your boat is properly tied down and a safety chain is used.
3. Check local and state laws concerning any trailer requirements.

4. Do not trailer with your boat's convertible top up. It will be severely damaged. Use a mooring cover properly tied down for extended trips.
5. You are required by state and federal laws to equip boat trailers with functional tail-lights and turn signals.
6. Some states require registration of boat trailers and license plates. Check with the Department of Motor Vehicles for regulations governing your particular state.

LAUNCHING

Pre-Launch Inspection Check-list

1. Inspect the hull and propeller for damage, excessive dirt, or marine growth, which will affect the boats performance as well as fuel efficiency.
2. Install the drain plug on boats that have been out of the water after first checking to see all bilge water has drained out. On boats already in the water, operate the bilge pump until the water flow stops.
3. Check the oil level and battery water level.
4. Check that all required equipment is onboard.
5. Check that all engine drains or petcocks are closed on I/O models.
6. Check fuel level. When inspecting or maintaining any fuel system, absolutely NO SMOKING OR OPEN FLAME.
7. If launching from a trailer, tilt the outboard or stern drive up to the high tilt position to avoid damage during the launch.

8. Before backing your boat down the launch ramp:
 - Remove all tiedowns.
 - Properly secure all loose gear.
 - Inventory your safety equipment.
 - Lock winch and trailer unit.
 - Disconnect trailer wiring from towing vehicle to trailer.

Launching Guidelines

NOTE: For more specific information, refer to your trailer owner's manual.

Here are some tips to remember when putting your Glastron boat in the water.

1. Have an individual at the launch ramp give you directions. Back slowly down the ramp. If the trailer needs to be maneuvered to the right, turn the towing vehicles steering wheel to the left. If trailer movement to the left is required, turn the steering wheel to the right. Always remember to launch your boat at a right angle to the shoreline.

NOTE: If you do not have experience in backing-up with a trailer, **pr a c t i c a l e** Take your trailer to an open area and master using it before you get into a confined public or private launch site.

2. When the boat's transom is in several inches of water, STOP the towing vehicle, leave it in gear, turn OFF the engine, and set the hand brake.
3. Do not unclasp the winch cable from the bow eye until a mooring line has been secured.

NOTE: See the Mooring Lines information that follows this portion for suggested securing procedures.

4. To keep the boat from drifting, the other end of the mooring line must be secured by an individual, or a mooring element (i.e., dock cleat, pier pillar, etc.) on shore.
5. Launch the boat; move it down and OFF the trailer into the water.
6. Make sure the boat is still secured to the mooring element.
7. Pull your towing vehicle away from the launch ramp.

8. Only park in designated parking areas. When parking, be sure your towing vehicle and trailer do not block other boater's from approaching the launch ramp or hinder their ability to maneuver a boat and trailer when launching.

Mooring Lines

The mooring lines you will use most often are the bow line, the stern line, and spring lines as shown on Figure 3.1. Each line has a specific purpose. The bow line and the stern line secure your boat's bow and stern. The two

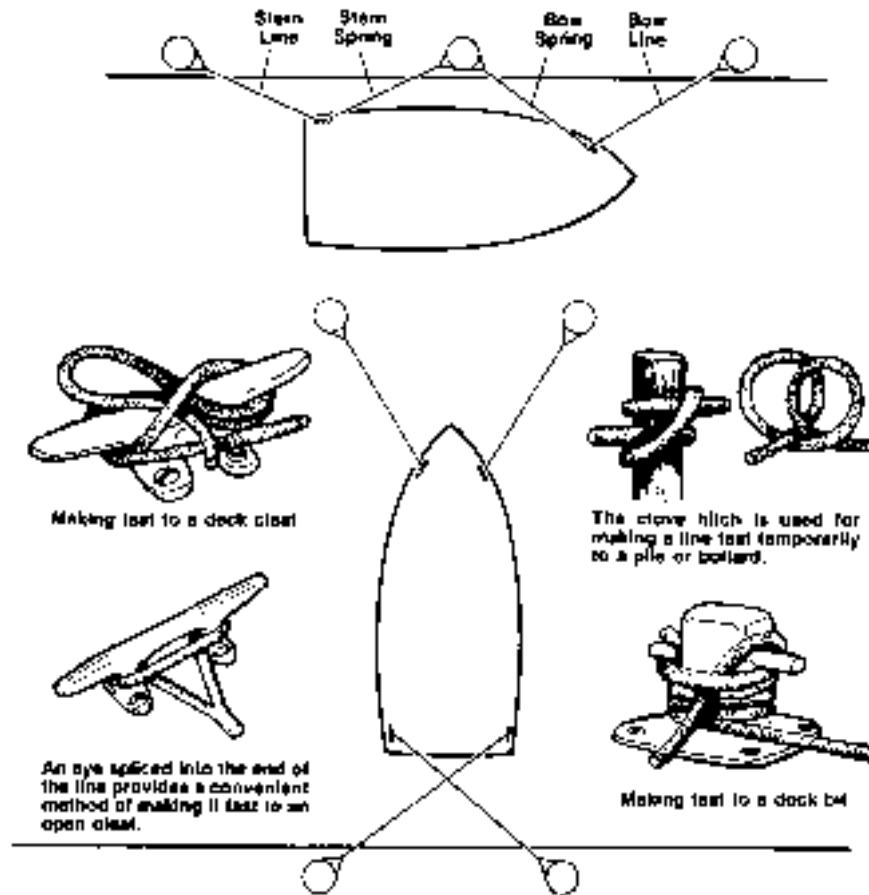

FIGURE 3.1 MOORING LINES

spring lines keep your boat from moving forward or backward when you are moored alongside a dock.

Mooring lines must be long enough to secure your boat in any docking situation. For example, the length of the lines for a 16-foot runabout should be at least 15 feet. An eye splice at the end of each line (shown on Figure 3.1) works well with bow or stern cleats.

NOTE: If you are mooring your boat in an area where tides are a consideration, be sure to leave slack in the lines to make up for the rise and fall of the water.

If you are mooring your boat for a short time, bow and stern lines may be the only lines you will need. If you are mooring your boat for a longer time or the currents are swift, you should use spring lines. The stern spring line leads from the boat's stern cleat forward to the piling or cleat on the dock. The bow spring line leads from the bow cleat aft to the dock. (See Figure 3.1.)

If you are mooring your boat in a slip, bow and spring lines, port and starboard, will keep your boat in position.

- Make a loop in one end of the line.
- Pass the loop through the hole in the base of the deck cleat.
- Then pass the loop back over the deck cleat.
- The line can now safely secure your boat.

Mooring lines may remain secured to the boat's deck cleats while underway. Coil and place lines where they cannot tangle inside of deck gear or the propellers.

When securing the boat with a mooring line:

- Run the line from the boat's deck cleat around a secure mooring element (i.e., dock cleat, pier pillar, etc.).
- Bring the end of the line back into the boat. This allows you to untie the line without leaving the boat.
- When departing, remove the line from around the mooring element, cast-off the line, and bring the entire length of line onboard.

LOADING

NOTE: Boats under 26 feet in length are subject to U.S. Coast Guard safe loading or labeling requirements.



CAUTION: Do not exceed the ratings shown on the capacity plate. An overpowered boat can become unstable, sometimes resulting in loss of control or capsizing. An overloaded boat can become sluggish and hard to handle. Overloading or overpowering can also reduce freeboard and increase the danger of swamping, particularly in rough water. In addition, overloading or overpowering is illegal under most state laws and the Glastron Warranty is void if the owner exceeds the recommended capacity ratings.

When loading your Glastron boat, remember to distribute the load evenly. Keep the load low and do not overload. The capacity plate affixed to your Glastron boat states the maximum load capacity. The plate shows persons and gear in pounds that the boat will safely handle under normal conditions. The U.S. Coast Guard establishes these load capacity ratings.

When loading always step onto the boat, never board by jumping. Have someone on the dock pass your gear

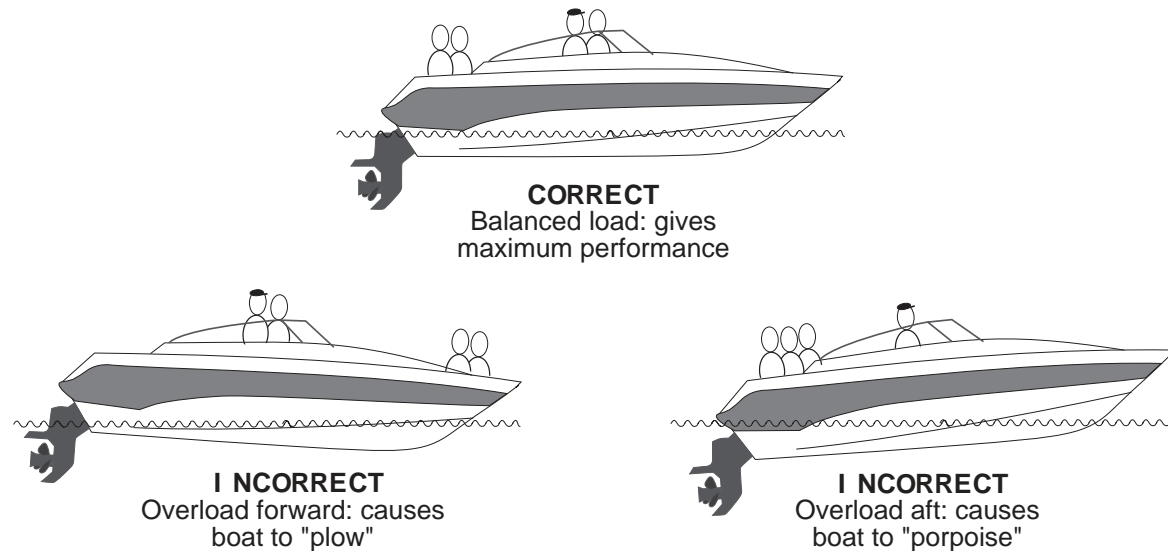

FIGURE 3.2 – LOADING PASSENGERS

aboard. Secure all gear firmly so it will not move or interfere with operation of the boat.

Passengers should board the boat one-at-a-time and be seated. Passengers should remain seated during loading of the boat to maintain an even trim. **Do not** allow passengers to ride on the bow with feet hanging over the side or to ride while sitting on the stern or gunwales. To avoid injuries to passengers on closed bow models, passengers are not to sit on the bow cushion area while underway. Falls from moving boats are a major cause of fatal recreational boating accidents.

CAUTION

CAUTION: On bow rider boats, passengers seated in the bow rider area should not obstruct the driver's vision. Keep the driver's line-of-sight clear to prevent accidents.

IMPORTANT: Falls from moving boats are a major cause of fatal recreational boating accidents. Do not allow passengers to ride on the bow with feet hanging over the side or ride while sitting on the stern, gunwales, or seat backs. The Coast Guard considers these acts to be negligent or grossly negligent operation and prohibits them by law.

IMPORTANT: The presence of the capacity plate does not relieve the boat operator from the responsibility of using common sense or sound judgment. Turbulent waters and adverse weather conditions will reduce the maximum load capacity rating of the boat.

FUELING RECOMMENDATIONS

While alcohol boosts the octane level of gasoline, it also attacks the rubber fuel distribution lines and even metal fuel system components. Alcohol will permeate most fuel hoses and other components such as fuel pump, gaskets, and seals. Alcohol also contributes to fuel system contami-

nation. Phase separation is common in alcohol blend fuels since alcohol absorbs water and separates from the fuel causing a gasoline rich top layer, and an alcohol/water layer on the bottom.

⚠ WARNING

WARNING: Do Not use fuels that incorporate any form of alcohol or alcohol derivatives. Alcohol destroys marine fuel system hoses and components, that could result in hazardous leaks, fire, and explosion.

⚠ WARNING

WARNING: Use only marine fuel hose marked "USCG Type A" if replacement is necessary. Inspect all fuel distribution lines often to reduce the risk of fire hazard.

If only fuel containing alcohol is available, or the presence of alcohol is unknown, you must perform more frequent inspections for leaks and abnormalities. Any sign of leakage or deterioration requires replacement before further engine operation.

Preliminary Guidelines

1. Safely secure your boat to the dock.
2. Do not smoke, extinguish all open flames, STOP all engines and other devices that could cause sparks, **including the bilge** ~~Do not use~~ electrical switches or accessories, shut OFF all stoves that may produce a spark or flame.
3. Close all hatches, windows, doors, and compartments to prevent the accumulation of fuel vapors.

⚠ WARNING

WARNING: Vapor from spilled fuel is heavier than air and will flow to the lowest part of the boat. Ventilate before starting.

4. Ensure a fire extinguisher is readily available.
5. Remove portable fuel tanks from the boat when filling. Wipe any spilled fuel from portable tanks before placing them in boat.
6. Do not store fuel in areas that are not adequately ventilated.
7. Use only fuel lubricants recommended by the engine manufacturer.

⚠ DANGER

DANGER: Gasoline vapors are highly explosive. Follow all safety precautions before, during, and after fueling.

Fueling

NOTE: See Section 2 Systems & Components for your boat's fuel tank capacity.

1. Always fuel in an area supplying sufficient lighting conditions. Gasoline spills are unnoticeable under poor lighting or in darkness.
2. Remove the fuel fill plate.

3. Insert the fuel supply nozzle, keeping the nozzle in contact with the fuel fill plate while fueling, to guard against static produced sparks.

I MPORTANT:When fueling or having your boat fueled by an attendant, be sure the waste and/or water fill plate is not mistaken for the fuel fill plate.

4. Stand away from the fuel tank vent and fill plate during fueling. Splash-back may occur and can be an eye irritant as well as a fire hazard.
5. *Avoid spillage.* Wipe any excess fuel immediately.
6. After pumping approximately 10 gallons of fuel into the fuel tank, inspect the engine and fuel tank area for any signs of fuel leakage. Continue fueling if no leaks or other problems are detected.
7. Allow space at the top of the tank for thermal expansion.
8. If fuel cannot be pumped in at a reasonable rate, check for fuel vent blockage or kink in the line.

After Fueling

1. Replace the fuel fill plate and wipe up any fuel spillage. Properly discard any rags that you may have used to wipe up fuel spillage in a safe place.
2. Open the engine compartment and all hatches, windows, doors and other compartments that were closed during fueling. Inspect these areas for the odor of fuel vapors and visible fuel leakage. Any sign of fuel leakage or any indication of vapors must be investigated and corrected before starting the engine.

3. Run the bilge blower for at least five (5) minutes before starting the engine. Continue to run the bilge blower until the boat is underway and has reached its cruising speed.

GETTING UNDERWAY

Instrumentation

Instruments on the dashboard are important for monitoring the performance of your boat's engine and alerting you to possible problems or causes of problems. Ask your Glastron dealer about the normal readings of the gauges when you take delivery of your boat. These readings provide you with a reference point for the life of the engine. Remember though that engine instruments have a tolerance for accuracy, and the readings on some gauges may fluctuate. Always check out the cause for readings consistently above or below a normal reading.

NOTE: Some models do not have all the instruments described in this section. Some models are equipped with multifunction engine gauges and alarms. See engine manual for additional information.

Fuel Gauge

Displays the amount of fuel contained within the fuel tank(s). The most accurate reading of the fuel gauge is at idle speed when your boat maintains an approximately level position. Underway, the fuel gauge will usually read higher than actual due to bow of the boat being higher than at rest. Since gauge readings are approximate, they should be compared to the hours of use versus known fuel consumption, or gallons per hour (GPH). The most common practice of good fuel management is the one-third rule. You use one-third of your total fuel onboard to travel to your destination and one-third in returning. The remaining one-third in the fuel tank should be reserved for emergencies.

Oil Pressure Gauge

The oil pressure gauge will reflect most, if not all, serious problems that may occur within your engine. A pre-set valve in the oil pump controls the maximum oil pressure. If a complete loss of oil pressure occurs, **stop the engine immediately**. Serious damage to the engine can result after loss of oil pressure if the engine continues to run. Check the engine oil level and fill if low. If oil level is full and gauge reading is low, contact your Glastron dealer or a qualified mechanic to rectify the problem. **Do not restart the engine until correcting the problem** or manufacturer's specifications for correct pressure ranges.

Tachometer

Displays the number of revolutions per minute (RPM) that the engine is running. The gauge displays increments of 100. The tachometer will show the RPMs necessary under various engine operating conditions. Consult with your Glastron dealer if you require additional information. Do not exceed engine manufacturer's recommendations.

Speedometer

Indicates boat speed in MPH (miles per hour). The accuracy of this instrument depends on the placement and cleanliness of the pick-up tube. The pick-up tube should be tilted up for trailering or shallow water, and down while underway.

Temperature Gauge

Displays the temperature of the engine water cooling system. This gauge should always be checked right after starting the engine. Marine engines draw external water, circulate it through the heat exchanger on the engine, and expel it overboard through the exhaust system. If the temperature gauge shows a hot condition, **stop the engine immediately**. Refer to your engine owner's manual for instructions and corrective action.

Voltmeter

Displays battery voltage. Under normal engine running conditions (1000 RPMs or higher), the voltage will range between 11 and 14 volts when the alternator is charging. With the engine OFF and ignition key or switch ON a fully charged battery is indicated by a high voltmeter reading. Significantly higher or lower readings show a battery problem, alternator malfunction, or heavy drain on the battery. You should check the charging system and battery system for these higher or lower readings. An oscillating reading shows a loose voltage regulator connection or loose belts. Displayed low voltage readings after stopping engine shows a bad battery or heavy load on the battery. Refer to your engine owner's manual for proper gauge readings.

Power Trim Gauge (Optional)

Indicates the relative position of the drive unit. This should be read carefully as it does not show position of the drive unit in degrees. Proper trim should be indicated by bow attitude and engine RPM.

CONTROLS

Steering Control

It is important that you get the "feel" of your boat's steering system. Steering does vary from boat to boat depending on hull shape, engine type, water and wind condition, and load.

Turn wheel from full left to full right and make certain the engine or drive unit is turning correctly. The system should run freely and smoothly.

Many I/O models are equipped with power steering. Check the fluid level and belt tension before starting. The cable output end of the steering system should be kept clear of fuel lines, control cables, electrical wiring, and other onboard gear when the engine is moved through its full operating range.

⚠ CAUTION

CAUTION: Do not over-tighten bolts or nuts that have been previously tightened. Use only manufacturer's specifications and parts when repairing or replacing steering parts.

To maintain a straight course, keep at least one hand in control of the steering wheel at all times while underway.

Throttle/Shift Control - I/O

NOTE: For optional or Glastron dealer installed controls, see the information supplied by the manufacturer of the control.

IMPORTANT: Allow the engine to warm up before engaging the shift control. Monitor all instruments while engine is idling during warm up. See the engine manufacturer's specifications for proper operating ranges.

Place the throttle/shift control handle in the NEUTRAL position. The engine should not start unless the control is in NEUTRAL, or the NEUTRAL safety switch is activated by pulling the entire handle or knob out toward the centerline of the boat.

The throttle/shift control regulates the RPM of the engine. Forward movement of the throttle increases the RPM of the engine. It also increases boat speed through the water when the engine is in either forward or reverse gear. The throttle control also acts as the gear shift lever to control the forward and aft movement of the boat.

Moving the throttle forward from the neutral position engages the shifting mechanism causing the boat to move forward. Continuing the forward movement of the throttle will increase engine RPM, and cause the boat to move faster in a forward direction.

Moving the throttle aft from the neutral position reverses

the shift mechanism causing the boat to move backward. Continuing the aft movement of the throttle will increase engine RPM and cause the boat to move faster in a backward direction.

When maneuvering at low speeds you can reverse (move throttle back or aft) the shift mechanism. This will result in a braking action.

⚠ CAUTION

CAUTION: When shifting between forward and reverse, always pause in neutral for a few seconds before reversing the rotation of the propeller(s). This will prevent unnecessary damage to the drive system.

⚠ WARNING

WARNING: High speed acceleration in reverse can create a wake that could wash over the transom and flood the boat.

Dual Lever Controls

Some models are equipped with dual lever controls. A separate throttle lever, with a red handle, is located closest to the driver on his right hand side. A black handled gear shift lever is located to the right of the throttle lever.

The neutral detent position on the gear shift lever is located in the middle of the lever's travel. Pushing the lever ahead shifts the stern drive into forward, and pulling the lever back all the way shifts the stern drive into reverse.

⚠ CAUTION

CAUTION: Before moving the gear shift lever, make sure the throttle is in the idle position. Failure to do so could cause loss of boat control, injury to occupants, and engine and drive system damage.

The throttle lever is in the idle position when it is pulled all the way back. Advancing the throttle forward increases the engine RPM.

⚠ WARNING

WARNING: High speed acceleration in reverse could create a wake that can wash over the transom and flood the boat. Only maneuver in reverse at low speeds.

Throttle/Shift Controls - Outboards

NOTE: For optional or Glastron dealer installed controls, see the information supplied by the manufacturer of the control.

The controls on your boat are of the single lever throttle/shift type.

⚠ CAUTION

CAUTION: The throttle on a hand operated remote control does not return to idle as on an automobile, when the pressure is released. Make sure you can reach the control lever quickly at all times when the engine is running.

The NEUTRAL safety switch is activated by placing the control lever in the NEUTRAL position and pulling the entire hub of the handle toward the center of the boat. This allows the throttle to be operational for warm up or “clearing out” the engine while the shift remains in NEUTRAL.

NOTE: This may vary between the different types of controls used by the outboard manufacturers. Please read the instructions provided with your engine and control system.

⚠ CAUTION

CAUTION: Never pull the knob or handle out while the engine is in gear. This can cause jamming of the control, possible improper control, or gear selection.

Stopping-You do not have brakes on a boat.

Practice stopping maneuvers and learn early how your boat reacts. From forward motion, pull back the throttle towards NEUTRAL. Depending on your speed, the distance the boat travels until it comes to a complete stop will vary. The ability to measure this distance will only be acquired through experience.

To aid in a quicker stop, the throttle/shift can be moved to the reverse position once it has been returned to NEUTRAL, and the engine RPM has decreased to idle speed.

NOTE: Be certain that all persons who operate the boat are acquainted with all facets of boat handling.

PRE-CRUISE CHECK

1. Check the weather forecast. Determine if the cruise planned can be made safely.
2. Be sure all necessary safety equipment is on board and operative. This includes items such as the running lights, horn, spotlight, life saving devices, etc.
3. Ensure an adequate amount of fuel is on board.
4. Be sure you have sufficient water and other provisions on board for the cruise planned.
5. Leave a written message listing details of the planned cruise with a close friend ashore.

STARTING PROCEDURES

The operation and maintenance manual supplied with your engine provides pre-start, starting, and cold-starting instructions. The following information is merely a guide and not intended to explain in detail all starting procedures and instructions. **Refer to your engine owner's manual**

Preliminary Checks

1. Secure boat to the dock before attempting to start engine. The boat should be kept secure until the engine is running and warmed up.
2. Check lubricating and cooling fluid levels.
3. Check fuel supply to ensure you have enough fuel for your expected travel plan.
4. Open the engine compartment. Inspect for fuel odors and visible leaks in the fuel, oil, coolant, exhaust, and power steering systems. See your dealer for repairs if any leaks are found, or if there is an accumulation of fuel or oil in the bilge.

⚠ DANGER

DANGER: Gasoline vapors are highly explosive. To prevent possible explosion and fire, check the engine and fuel compartments before each engine start for the accumulation of fumes or fuel leakage. Always operate the blower for four (4) minutes before starting engine.

5. If your boat's bilge has collected any water (but not gas or oil) operate the bilge pump until the pump will not pump out any more water.
6. Always operate the bilge blower for at least four (4) minutes before starting engine. This is also true during

the starting process, and anytime you are operating your boat below cruising speeds. Check the blower output vent for air flow.

7. Make sure the throttle/shift control is in the neutral position.
8. Make sure passengers seated in the bow area do not obstruct the driver's vision.

Starting

1. Connect ignition interrupter lanyard to driver and helm switch.
2. When cold starting your boat, advance the throttle several times and leave it in the SLOW/START position. This will actuate the carburetor accelerator pump and feed fuel to the engine. Turn ignition key to START position.

NOTE: Engine will not turn over if throttle/shift control is not in the neutral position.

⚠ CAUTION

CAUTION: Do not continuously operate starter for more than 15 seconds without pausing. Allow starter to cool at least three (3) minutes between start attempts.

3. If engine fails to start, wait approximately three (3) minutes. Move throttle only once to the maximum position then back to the neutral position, and try to start engine again.
4. When engine is cold, run engine approximately one (1) to two (2) minutes at fast idle speed (1200 to 1500 RPM).
5. Once engine has warmed up, check temperature gauge to ensure engine temperature stays within optimum range. If temperature reading is abnormally high,

stop engine immediately and inspect for cause of high reading.

6. With engine running, voltmeter should show a reading between 11 and 14 volts.
7. Check steering operation. Turn steering wheel to full port and to full starboard while observing outdrive movement.
8. Inspect for fuel odors and visible leaks in the fuel, oil, coolant, exhaust, and power steering systems.
9. Make sure boat is still securely moored to the dock and engine is idling at 600 to 800 RPM. Then move the throttle forward and then aft, and back to neutral to check for proper operation of the shifting motion.

⚠ WARNING

WARNING: Engine and generator exhaust systems produce carbon monoxide (CO), a poisonous gas which is odorless, colorless, and heavier than air. Direct prolonged exposure can result in CO poisoning that may be harmful or fatal. Indications of excessive exposure to CO concentrations may include nausea, dizziness, and drowsiness.

To prevent excessive exposure and reduce the possibility of CO accumulation in the cabin and cockpit areas of the boat, the operator should provide adequate ventilation in each of these areas. Utilize all hatches, doors, windows, and side vents to increase air movement. See Section 1 for information about Carbon Monoxide DANGERS.

Acceleration

As you throttle-up and accelerate, your boat's angle of trim increases and causes the boat to ride bow-high. From a

maximum angle, the boat will level out to its planing attitude as you continue to accelerate.

⚠ CAUTION

CAUTION: Acceleration at full throttle is not recommended before the engine "break-in period" has been completed. This "break-in period" also coincides with the engine "twenty (20) hour check-up". Therefore, full throttle acceleration should not be attempted until your engine has surpassed this usage time.

The maximum angle is commonly known as the "hump". It is advised to get over the "hump" as quickly as possible due to limitations in visibility, handling, and performance in reaching the maximum angle. It should only take a few seconds at full throttle to get over the "hump". At that point, the boat reaches its planing attitude. After getting over the "hump", accelerate until reaching a comfortable plane, then throttle down to cruising speed. This also will provide for better fuel efficiency.

⚠ WARNING

WARNING: Check behind you before coming OFF plane. Many accidents occur each year as a result of a driver coming off plane while being followed by a boat that is unable to slow down in time to avoid collision.

Always look behind you and to both sides of the boat before slowing down. Tell your passengers your intentions to allow them to make adjustments to their balance or positions. Slowly pull back on the throttles. Glance back and see if a large following wave is approaching the transom. If it is, give the engine a little throttle as the wave arrives to keep the wave from rolling over the transom. Avoid making sharp turns while the boat is slowing.

TRIMMING

TILT/TRIM Control Switches

1. The standard trim control switch is usually located on the control lever handle. See your dealer for a complete explanation of trim control switch.
2. The switch controls the “trim” of your boat under various conditions, loads, and uses. Proper trim is very important in boating. Trim refers to the angle of the lower unit in relation to the bottom of the boat.
3. In the case of low or heavy bow attitude, the lower unit is normally trimmed too far under or forward. Trim the unit out or up to correct this situation.
4. If the bow is too high, your drive unit is trimmed up or out too far. Trim IN to correct.
5. A good practice is to get underway (especially when fully loaded or pulling a skier) with the unit trimmed all the way under or IN. After the boat is on plane, adjust the trim out slightly to obtain the proper bow attitude and engine RPM.
6. Trim also affects propeller selection and fuel efficiency. All models should be “propped” to attain the maximum recommended engine RPM in mid-trim position. It should not be necessary to run your boat at maximum trim. Never trim the lower unit to a point where the propeller cavitates or slips, which is evident by a rapid increase in engine RPM.
7. On performance boats, trimming out, in addition to raising the bow, also lifts the boat higher, gaining speed because of less hull in the water.

⚠ WARNING

WARNING: Excessive trim will decrease maneuverability, change steering characteristics, and may cause “porpoising” (bow oscillates up and down) or “chine walking” (rocking from side to side). USE POWER TRIM WITH CARE.

8. The high-tilt trailering position of the stern drive is controlled by a separate switch which is located on the control handle, dash, or switch panel. *Do not activate this switch while underway.* This can severely damage the lower unit.

NOTE: Refer to your drive unit(s) instruction manual or your dealer, regarding the power trim controls installed on your boat.

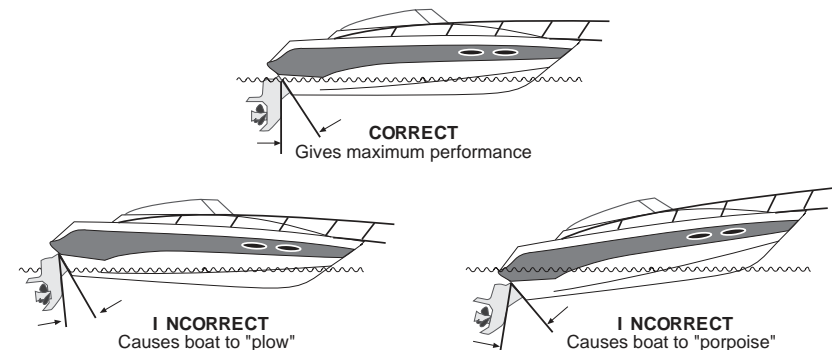

FIGURE 3.3 – TRIM / MOTOR ANGLE

TILT/TRIM Control Switches - Outboards

On outboard engines equipped with power trim, read the instructions provided by the engine manufacturer for correct usage.

On outboard engines without power trim, the trim angle can be controlled by using the following “Rule of Thumb”: If the bow runs low or heavy in the water, move the unit out one or two pin hole settings. If the bow runs too high or light in the water, move the unit in towards the transom one or two pin hole settings.

Trim Tabs

If your boat is equipped with trim tabs you can use them to adjust the boat’s trim to the optimum angle for load and water conditions. Trim tabs add lift to the boat’s stern, thereby changing the boat’s attitude (see Figure 3.4). This life can help the boat remain on plane at slower speeds than if no tabs were used.

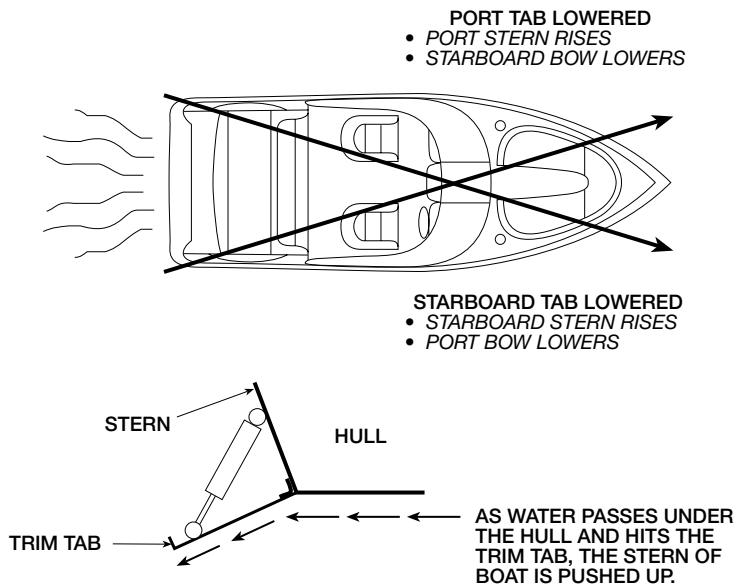

FIGURE 3.4 – TRIMMING WITH TRIM TABS

During one of your first boating expeditions, take the boat out onto open water and experiment with the trim tabs. After you get the boat on plane, set the tabs in various positions and note how the boat reacts. This will give you a feel for how the trim tabs work.

⚠ WARNING

WARNING: Loss of Steering Control Lower the tabs all the way at high speeds. You may lose steering control. Lower tabs a little at a time. Observe effect on boat operation before lowering further.

Used independently, trim tabs can also compensate for seas, winds, or uneven loads.

Head Seas	Trim drives in more than usual. Lower tabs to keep bow down and go at a slower speed.
Following Seas	To prevent taking seawater over the bow, trim drives and tabs to keep bow up.
Listing due to Quartering Seas, Beam Wind, or Uneven Load	Use tabs independently to adjust for list. If listing to starboard, lower port tab. If listing to port, lower starboard tab.

Remember that all boats react very slowly to trim tabs. Often operators do not give trim tabs time to work. Press the trim tabs switches for only two seconds at a time and then allow some time for the boat to react. If the boat is still listing after a minute or two, press the trim tab switch again for a two-second interval.

IMPORTANT: Basic safety precautions should always be followed with the operation of trim tabs. Do not step on trim tabs. Injury may occur from slipping.

It is possible to extend the cylinder life expectancy on your trim tabs. To do this, keep the cylinders retracted while at dockside. Press both trim tab controls down until tabs reach their full up position.

ENGINE SHUT DOWN

1. Turn OFF ignition switch.
2. Turn OFF all other switches.
3. Raise the lower unit to the high tilt or trailer position. This is to avoid damage to the propeller or lower unit before removing the boat from the water.
4. After securing the boat to the trailer (if removing from water), remove the drain plug and drain the bilge. If boat is being secured to floating dock, boat house, etc., and will remain in water, drain the bilge by using the boat's bilge pump.

RELOADING YOUR BOAT

1. Back the trailer into the water.
 2. When the trailer is in several inches of water:
 - STOP the towing vehicle.
 - Leave manual transmission in gear or place automatic transmission in park.
 - Turn off the engine and set the hand brake.
- NOTE:** If you have a bunk trailer, the trailer may need to be more than several inches in the water before loading.
3. Tilt the boat's stern drive up to the high tilt position to avoid damage while loading.
 4. Pull boat up onto trailer and secure safety cable.
 5. Start engine on towing vehicle and pull trailer out of water to boat securing area.
 6. Use tie-downs to secure boat on trailer.

7. Remove the drain plug.
8. Make sure stern drive is raised and secure.
9. Wipe hull down to prevent water spots and keep hull clean.
10. Make sure everything in the boat is secure or tied down. Place anything loose in towing vehicle.
11. Reconnect trailer lights. Check that lights are working.

ANCHORING

1. The weight of the anchor and diameter of anchor line should be governed by the size and weight of your boat. Obtain advice from your Glastron dealer before purchasing an anchor.
2. Keep anchor secure while underway to prevent damage or injury due to sudden shifting in the boat's attitude.
3. Make sure the anchor line is secured to the bow eye or deck cleat. Never tie to a rail, rail fitting, or other hardware which is not meant to support this stress.
4. Use two or more anchors if anchoring overnight or for extended periods. If not using two anchors, make certain there is sufficient clearance for your boat to swing in a full circle to prevent damage in case of shifting winds.
5. Make certain you have enough anchor line (or scope) for the depth of water. Your anchor line should be 6 to 7 times the depth of water anchored in. For example, you are in 20 feet of water, so use 120 to 140 feet of anchor line.

Dropping Anchor

1. Have a crew member carefully lower the anchor. Keep slight tension on the anchor while lowering and maintain your tension after anchor reaches bottom.
2. Maneuver the boat backwards slowly until the proper length of anchor line is handed out.
3. Fasten the anchor line around the bow eye or deck cleat. Anchor flukes should dig in and catch.

Watch for anchor drag by checking shoreline landmarks at the time the anchor is dropped and one-half hour later. If the boat has drifted away from these reference marks, the anchor is dragging and must be reset.

Weigh (pull in) Anchor

1. It is recommended to have the engine running when you pull in anchor.
2. Pull in the length of anchor line until the line is vertical. Pull firmly to lift the anchor's shank and free the flukes from the bottom.

If the anchor becomes stuck, attach the vertical line to the mooring cleat. Wave action on the bow may lift flukes from the bottom and free the anchor. If the anchor is still stuck, feed out a few feet of line and attach it to the bow cleat. Maneuver the boat around the anchor, keeping the line firm. Locate an angle that will pull the anchor free.

EMERGENCY PROCEDURES

The following information is provided so you, as the operator of your boat, can think about emergencies before they happen. Plan ahead so you will know what to do before you encounter any of these situations.

Storms

Storms sometimes appear without advance notice. Although weather information from meteorological observation and reporting stations is available, weather bureaus are known to have failures in their predictions or information gathering equipment. There is no substitute for a strong understanding of what action to take when the weather takes a turn for the worse. Many marinas fly weather signals. You should learn to recognize these signals and monitor your local weather forecasts before leaving port.

The present and forecasted weather conditions are of primary consideration, but a threat of possible storms should always be a concern. Observance of the following information will help in your safety afloat if storms do occur:

- Keep a watch on the horizon for approaching storm indicators.
- Turn radio ON. Dial in local weather station and monitor forecast. If your boat has a VHF radio, check the weather channels.
- The best possible situation is to return to a safe port if time allows.
- Close and secure all portals and hatches. Stow all loose gear below deck and tie down any gear required to remain on deck.
- Reduce speed as the seas build. Make sure all passengers are wearing their PFDs.
- If you lose power, keep the boat headed into the waves by rigging a sea anchor off the bow (Figure 3.5). If there is no sea anchor on board, use a canvas bucket or any object that will offer resistance.

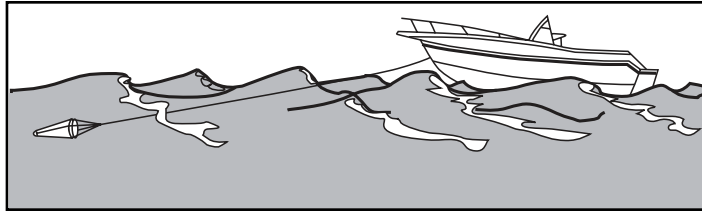

FIGURE 3.5 SEA ANCHOR

- Radar reflectors (if installed on your boat) should be 18 inches diagonally and placed 12 feet above the waterline.

Fog

Fog is a result of either warm surface or cold surface conditions. You can judge the likelihood of fog formation by periodically measuring the air temperature and dew point temperature. If the spread (difference) between these two temperatures is small, you likely will incur a fog situation. Remember the following guidelines:

- Turn on running lights.
- As fog sets in, take bearings and mark your position on the chart while continuing to log your course and speed.
- Make sure all persons aboard are wearing their PFDs.
- If your boat has depth finding equipment, take sounding and match them with soundings on your charts.
- Station a person forward on the boat as a lookout.
- Reduce your speed. From time to time, stop engine and listen for fog signals.

- Sound the proper horn or fog bell at proper intervals to warn other boaters.
- If there is any doubt in continuing boat movement, anchor. Listen for other fog signals while continuing to sound the proper fog horn or bell for a boat at anchor.

Running Aground

⚠ WARNING

WARNING: To prevent boat damage, DO NOT use deck hardware or water ski pylon for towing. Use a commercial towing service.

Operating in shallow water can present a number of hazards. Sand bars in narrow inlets are constantly shifting, making it difficult to mark them with buoys. Sometimes sand bars are indicated by waves as they form into breakers when passing over sand bars. In coastal areas, tides can change water levels by as much as 30 feet. Check with local marinas or Coast Guard stations for tide tables and current charts.

If your boat runs aground, first check persons aboard for injury. Then check for damage to the boat. If the drive unit strikes an underwater hazard, check for boat and drive unit damage. If the engine vibrates excessively after striking an underwater obstruction, it may indicate a damaged propeller. If vibration is noticeable, return to port slowly to prevent further drive and engine damage from an out-of-balance condition. Watch the temperature gauge to make sure you do not overheat the engine.

If the boat is not taking on any water, it may be possible to rock the boat by shifting the weight of the passengers and gear and by raising the drive unit while reversing the engine.

If you ground your boat on a sand bar, shut down the engine and seek help from another boater or radio for help. See your dealer as soon as possible, as sand ingested in the engine cooling system can cause major engine damage.

Warning Markers

It is a good idea to find out about hazardous areas and how they are marked by asking your local authorities.

- Boaters must also recognize the flag designs which indicate that scuba divers are present and keep well clear of the area.
- Watch for swimmers. Swimming areas may not be marked. Steer clear from the area and always remain alert.
- Distress flags indicate a fellow boater is in need of assistance.
- Navigation markers serve as a means of identifying navigable routes and indicate water hazards. Boaters should become familiar with navigation markers and stay within marked boundaries and clear of hazards.

REACTING TO EMERGENCIES

Be prepared to deal with emergencies before they happen. Try to formulate a plan for each type of emergency in advance so that decisions can be made quickly and without hesitation. Precious moments lost can mean the difference between losing and saving a life.

Flooding

If your boat starts taking on water, activate the bilge pump immediately. Make sure all passengers are wearing their PFDs. Open the engine compartment, look for the cause of the flooding. Check all hoses, through hull fittings, sea-cocks and strainers. If flooding occurs as a result of collision or grounding damage, call for assistance and head for shore if possible.

Capsizing and Man Overboard

By far, the largest number of boating fatalities involve capsizing and falling overboard accidents. By being prepared ahead of time with an appropriate plan of action, you can greatly lower your chances and your passengers' chances of becoming seriously injured.

Capsizing

Wear PFD's or have them readily available at all times. If your boat capsizes, and others were on board, locate them and guide them to the safety of the hull. Even if the boat floats in an upside-down position, stay with it. The boat hull is much easier for rescuers to spot than a human head sticking out of the water. DO NOT attempt to swim ashore, it may be further than it looks.

Man Overboard

Think through and follow these procedures if someone in your boat falls overboard.

- Remember, every second counts, you must act fast.
- Move throttles to idle position immediately and yell "MAN OVERBOARD."

- Throw some floating object overboard immediately. Keep your required Type IV PFD accessible at all times for such an emergency.
- Keep the person in the water in sight at all times. Have a passenger do nothing but watch the person. Do not go into the water to help the victim. One person in the water is enough trouble.
- Circle around quickly, approaching into the wind and waves. When the person is alongside, put the engine in neutral and throw them a Type IV PFD with a line attached or extend a paddle or boat hook within his/her reach.

Collision

If a serious collision occurs, you should first check the condition of all passengers aboard, then inspect your boat to determine the extent of damage.

1. Make sure all persons aboard are wearing their PFDs.
2. If you need help and your boat has a ship-to-shore radio, first contact the U.S. Coast Guard (VHF Channel 16) or other rescue authorities immediately.
3. Prepare to assist the other vessel unless your passengers and/or boat are in danger.
4. If the bow of the other boat penetrated your boat's hull, prepare to block the opening once the boats are separated.
5. Shore up the hole with a spare PFD or bunk cushion from your boat.
6. While blocking the hole, trim the boat so that the hole is out of the water.

Fire

Most fires are caused by electrical problems or careless fueling practices. A fire on board your boat is a serious emergency. You must work quickly to implement safety procedures. If a fire occurs, immediately stop the engine.

1. Make sure all persons aboard are wearing their PFDs.
2. If the fire is small, attempt to put it out with your fire extinguisher. If the fire is in the engine compartment, turn off the bilge blower. Do not open the engine compartment. This feeds oxygen to the fire and may cause it to flare up.
3. If the fire gets out of control, execute a distress signal and call for help if equipped with a ship-to-shore radio.
4. All persons aboard should jump overboard and swim a safe distance away from the flames.

I MPORTANTAll persons aboard should know the location and proper operation of the fire extinguishers.

GUIDELINES

- Use only approved marine cooking and heating systems.
- Open flames demand constant attention.
- Keep flammable materials in approved containers in a overboard vented locker sealed from the interior of the boat.
- Ensure ventilation systems are unobstructed.
- Remove mooring covers before starting engine.
- Check the bilge for fuel leaks.

- Extinguish smoking materials carefully.
- Use special care with flame or high temperatures around urethane foam.
- Check cleaning products for flammability.
- Ventilate when cleaning or painting.
- Disconnect electrical system from its power source before performing maintenance.
- Replace breaker or fuse with same amperage device.
- Electrical appliances must be within rated amperage of boat circuits. Observe the boat carefully while the electrical system is being energized.
- Allow only a qualified marine electrician to service the boats electrical system.

Medical Emergency

Accidents while boating can and may happen. Be prepared to handle these emergencies when they happen. Keeping a first aid kit and dry blankets on board can assist during these situations. It is also a good idea to contact your local Red Cross for information and training on first aid and CPR.

Propulsion Failure

Before you call for help regarding an engine or drive unit failure, it is a good idea to eliminate the possibility of simple problems. Turn off the engine and check to see that (1) there is fuel in the tank; (2) the engine cooling intakes on the outdrive are not clogged; (3) props are clean and free of weeds, netting, etc.; (4) no hoses are leaking; (5) there is oil in the engine.

Once you have checked out the possibilities listed above and find they are not the problem, call for help giving your position and a detailed description of your boat.

Control Failure

In the unlikely event of a shift/throttle failure, shut down the engine immediately. Carefully check the control connections in the engine compartment to see if they are secure. If not, try to locate the attaching hardware and reassemble. If that is not possible, try to use whatever is available such as paper clips, hair clips, tape, etc., to secure the connections. If a temporary repair is made, return to port at the slowest steerable speed and be prepared to take emergency action should the temporary repair fail also. Have your dealer make repairs before using the boat again.

Steering Failure

If a problem with the steering occurs, shut down the engine immediately. Check the connections to the outboard motor or drive unit in the engine compartment. Some boats have a push/pull cable while others will have hydraulic hose connections. With cable connections, check the attaching hardware and tighten it if necessary. If you have hydraulic hose connections, check to see if they are leaking. If so, tighten the connections and check the hydraulic fluid reservoir level. Most stern drives are power assisted and have their own hydraulic reservoir and engine mounted drive pump; check the level of reservoir and drive pump belt. If the steering is not operating properly, do not operate the boat and call for assistance.

This section contains a general maintenance schedule and troubleshooting chart. If you do not fully understand the information contained within this section of your owner's manual, or any of the related product service manuals, contact your Glastron dealer. Glastron Boats recommends maintenance be performed at an authorized Glastron dealer. The following information is of a general nature.

SERVICE & MAINTENANCE SCHEDULE

The following time intervals are intended to be used as a guide under normal operating conditions. Other operating conditions may warrant shorter time intervals. Instructions for performing listed items can be found in either your owner's manual, installed equipment manuals, or by contacting your Glastron dealer.

Time Interval Description

1 ~~4~~ 8 hours after launch

2 ~~2~~ 5 hour check during each boating season

3 ~~2~~ Twice during boating season/Every 6 months/Every 100 hours of operation

4 ~~2~~ Beginning of boating season/Every 12 months/Every 200 hours of operation

Maintenance Terminology

Check- to observe for satisfactory conditions, accuracy, safety or performance.

Inspect to examine closely, in critical appraisal, while testing or evaluating components or systems.

Lubricate to apply a lubricant (oil, grease, etc.) as specified for reducing friction, heat and wear between solid surfaces.

ITEM	TIME INTERVALS			
	1	2	3	4
Engine & Drive System				
Perform engine and drive unit maintenance as recommended by manufacturer.				
Inspect :				
Cooling system hoses & clamps		X	X	X
Drive belt tension (all)			X	X
Check:				
Prop for trueness				X
Propellers				X
All thru-hull fittings				X

ITEM	TIME INTERVALS			
	1	2	3	4
Engine & Drive System				
Clean:				
All gauges				X
Spray ignition switch w/contact cleaner				X
Control System				
Adjust throttle and shift		X		X
Test "neutral" safety switch				X
Lubricate cables and control				X
Steering System				
Inspect linkage and connections			X	X
Adjust steering		X		X
Lubricate steering system				X
AC & DC Electrical System				
Inspect :				
Battery connections			X	X
Battery cable				X
12V wiring and connections				X
Check:				
Battery water level		X	X	X
Operation of 12V electrical equipment		X		X
All receptacles and connections			X	X
Bilge blower operation		X	X	X

ITEM	TIME INTERVALS			
	1	2	3	4
Fuel System				
Inspect :				
For fuel leaks and condition of fuel hoses		X	X	X
Fuel pump & filter		X	X	X
Fuel tank			X	
Clean fuel filter		X	X	X
Fresh Water System				
Inspect :				
Fresh water tank				X
Complete system		X		X
Flush water system				X
Ventilation & Drainage				
Check:				
Garboard (Hull) drain	X		X	X
Operation of windshield wing vents				X
Operation of bilge pump(s)		X		X
Clean:				
Vent system			X	X
Bilge pump(s)		X		X
Interior Equipment				
Perform head and stove maintenance as recommended by manufacturer.				
Inspect thru-hull fittings	X	X	X	X
Clean:				
Ice chest				X
Cabin and hatch screens				X

ITEM	TIME INTERVALS			
	1	2	3	4
Exterior Equipment				
Check:				
Compass for magnetic deviation				X
Clean navigational lights			X	X
Seating & Canvas				
Clean upholstery				X
Spray upholstery with Lysol™				X
Wash canvas				X
Fiberglass Components & Hull				
Check rail and seat fastenings				X
Clean fiberglass			X	X
Wax hull sides and all non-tread areas				X
Inspect fiberglass areas for damage				X
Perform minor touch-up repairs				X

TROUBLESHOOTING CHART

The following troubleshooting procedures are designed to correct minor problems with the engine, inadequate performance, and vibration. The chart shows the problem, cause, and correction in the order of probable occurrence. Refer to your engine manual and use a common sense approach when rectifying problems. If the difficulty appears too complex or risky, contact your Glastron dealer or a qualified Glastron marine technician.

⚠ CAUTION

CAUTION: Disconnect all battery cables before performing maintenance, inspections, checks, and repairs.

⚠ DANGER

DANGER: Do Not disconnect or reconnect battery cables if gasoline fumes are present.

Engine

<i>PROBLEM</i>	<i>CAUSE</i>	<i>CORRECTION</i>
Engine will not crank (Ignition system)	Throttle lever in wrong position Loose wire in starting circuit Ignition switch defective Defective solenoid Battery switch in OFF position Dead battery Spark plug(s) fouled or broken Distributor cap broken, wet, cracked, or dirty	Check position of throttle lever, ensure it's in the NEUTRAL position. Tighten all wiring connections. Test switch continuity. Replace switch as required. Replace solenoid. Turn dual battery switch to battery setting #1 or #2; if equipped. Recharge or replace battery. Clean, adjust gap, or replace. If wet or dirty, wipe with cloth and cleaning solvent. Inspect cap for cracks, carbonized paths (inside and out); replace cap as required.

PROBLEM	CAUSE	CORRECTION
Engine will not crank (Ignition system) (continued)	Hydrostatic lock	Remove spark plugs and crank engine. If engine cranks water is entering cylinders from exhaust system, or from a possible gasket leak. If water enters engine through exhaust line, improper draining of exhaust system exists. Contact your Glastron dealer or a qualified marine mechanic to correct problem.
Engine cranks but will not start	<p>Lack of fuel</p> <p>Improper starting procedure</p> <p>Choke plate sticking</p> <p>Clogged fuel filter</p> <p>No fuel reaching carburetor (providing all fuel valves are open)</p> <p>Engine flooded</p> <p>Contaminated fuel</p> <p>Ignition interrupter switch</p>	<p>Clean fuel filter, check fuel level, and check anti-siphon valve.</p> <p>See your engine manual to review starting procedure.</p> <p>Check thermostatic spring housing adjustment.</p> <p>Check fuel filter, replace if required.</p> <p>Check fuel pump, fuel pump filter, carburetor fuel filter, and fuel tank line for cracked flanges or restricted fittings, check anti-siphon valve.</p> <p>Do not attempt to start engine for at least 5 minutes. For hot engine, fully advance throttle once, return throttle to NEUTRAL then crank engine</p> <p>Inspect for water or other contaminants in fuel. If contaminated, drain tank and flush with fresh fuel.</p> <p>Connect lanyard to switch and driver.</p>

<i>PROBLEM</i>	<i>CAUSE</i>	<i>CORRECTION</i>
Low cranking speed	Loose or dirty electrical connections or damaged wiring Bad battery Engine oil too heavy for current temperature	Check all related electrical connections and wires. Test battery (See your engine manual). Drain oil and refill with correct grade and viscosity oil (See your engine manual).
Starter will not crank engine	Discharged battery Corroded battery cables Loose connection in starting circuit Defective starter switch Starter motor brushes dirty Jammed starter drive	Charge battery, change dual battery switch to ALL; if equipped. Clean terminals. Check and tighten all connections. Replace switch. Clean or replace brushes. Loosen starter motor, then free locked gear.
Poor acceleration	Accelerating pump Throttle not fully open Ignition or carburetor Flame arrestor dirty or air intake obstructed Engine overheating	Replace. Inspect cable and linkages for binding, obstructions, or loose fasteners. Service ignition system and carburetor. Clean flame arrestor and check air intake. Check engine temperature (See your engine manual).

<i>PROBLEM</i>	<i>CAUSE</i>	<i>CORRECTION</i>
Engine runs but misfiring	<p>Fouled spark plug(s)</p> <p>Improper timing</p> <p>Wet spark plug wires</p> <p>Carbon tracked distributor</p> <p>Loose ignition wires</p> <p>Cold engine with improperly set choke</p> <p>Defective fuel pump</p> <p>Partially clogged fuel filter</p> <p>Incorrect carburetor mixture</p> <p>Contaminated fuel</p>	<p>Remove and clean, replace as required.</p> <p>Check timing and adjust as required (See your engine manual).</p> <p>Inspect wires, wipe dry, replace damaged wires.</p> <p>Clean, replace as required.</p> <p>Inspect all wire connections.</p> <p>Check your engine manual for proper choke setting.</p> <p>Repair, replace as required.</p> <p>Clean fuel filter, replace as required.</p> <p>See your engine manual for proper carburetor adjustment.</p> <p>Drain fuel tank and flush clean; replace fuel filter.</p>
Excessive fuel consumption	<p>Restriction in flame arrestor</p> <p>Faulty fuel pump</p> <p>Dirty flame arrestor screen</p> <p>Distributor breaker points or spark plugs improperly set or bad</p> <p>Incorrect timing</p>	<p>Remove and clean flame arrestor.</p> <p>Repair, replace as required.</p> <p>Clean, replace as required.</p> <p>Clean, set or replace breaker points and spark plugs.</p> <p>Time engine.</p>

<i>PROBLEM</i>	<i>CAUSE</i>	<i>CORRECTION</i>
Excessive fuel consumption (continued)	Choke not properly adjusted Float level too high	Adjust choke as required. Reset float level as required (See your engine manual).
Blue exhaust smoke	Lube level too high Oil too thin Oil overheated	Drain off excessive oil. Drain and replace oil (See your engine manual). Check cooling system.
Black or gray exhaust smoke	Fuel mixture too rich Choke locked Poor carburetor setting Carburetor fuel level too high Clogged flame arrestor	Adjust carburetor. Lubricate and adjust. Readjust carburetor (See your engine manual). Adjust carburetor float. Clean, replace as required.
White exhaust smoke	Engine misfiring Spark plugs dirty or not gapped correctly Engine overheating	See your engine manual. Clean, adjust gap, replace as required
Low oil pressure	Insufficient oil in crankcase	Check and add correct grade and viscosity oil. Visually check engine for leaks.

<i>PROBLEM</i>	<i>CAUSE</i>	<i>CORRECTION</i>
Low oil pressure (continued)	Excessive oil in crankcase Diluted or improper grade and viscosity oil Oil leak in pressure line	Check and remove any excess amount of oil. Check for cause of excessive oil (improper filling, bad fuel pump, etc.). Change oil and oil filter, using the correct grade and viscosity oil. Inspect all oil lines and tighten all connections as necessary.
No oil pressure	Defective gauge, gauge tube, or oil line No oil in engine	Replace gauge, or tube, and tighten or replace line as necessary. Fill with proper grade and viscosity oil (See your engine manual).
High oil pressure	Oil grade too heavy Dirt or obstruction in oil lines	Drain oil and replace with proper grade (See your engine manual). Drain and clear oil system. Check for bent or flattened oil lines, replace as required.
Knocking or pinging	Incorrect fuel Incorrect timing Pre-ignition Overheated engine Cooling system trouble	Drain tank, replace with proper fuel. Time engine (See your engine manual). Clean or replace spark plugs, check engine timing. Check engine cooling system. Check water intake connections for leaks.

<i>PROBLEM</i>	<i>CAUSE</i>	<i>CORRECTION</i>
Rough running	<p>Choke not operating</p> <p>Faulty fuel pump</p> <p>Idle speed too low</p> <p>Faulty ignition system components</p> <p>Clogged fuel filter</p> <p>Contaminated fuel</p> <p>Fuel lines or fuel tank vent line kinked or clogged</p> <p>Flame arrestor plugged with foreign material or air intake hose obstructed</p>	<p>Check choke linkages for binding or obstruction.</p> <p>Refer to your engine manual for fuel pump testing procedures.</p> <p>Check idle speed, adjust as required.</p> <p>Service ignition system (See your engine manual).</p> <p>Replace fuel filter.</p> <p>Inspect fuel for water or other contaminants. If contaminated, drain tank then flush with fresh fuel.</p> <p>Use compressed air (20 psi or less) to blow out obstruction. Replace line if kinked.</p> <div style="border: 1px solid black; padding: 2px; text-align: center;">⚠ WARNING</div> <p>WARNING: Wear protective eye wear when performing compressed air cleaning.</p> <p>Clean flame arrestor and check hose.</p>
Engine overheating	<p>Bad sending or receiving unit</p> <p>Loose wiring connections at sending or receiving unit</p>	<p>Replace unit(s).</p> <p>Tighten all connections.</p>

<i>PROBLEM</i>	<i>CAUSE</i>	<i>CORRECTION</i>
Engine overheating (continued)	<p>Worn or broken impeller in sea water pump</p> <p>Clogged oil cooler</p> <p>Exhaust lines plugged</p> <p>Ignition timing late</p> <p>Choke valve locked closed</p> <p>Collapsed water pump suction hose</p> <p>Loose or worn belts</p> <p>Restricted water intake</p>	<p>Replace impeller.</p> <p>Remove obstruction.</p> <p>Remove obstruction.</p> <p>Time engine.</p> <p>Free choke valve movement.</p> <p>Install new hose.</p> <p>Adjust or replace belts as required.</p> <p>Clean water intake.</p>
Sludge in oil	<p>Infrequent oil changes</p> <p>Dirty oil filter</p> <p>Water in oil</p>	<p>Drain, then refill with proper grade and viscosity oil.</p> <p>Replace oil filter.</p> <p>Drain, then refill. If trouble persists, check for cracked block, defective head gasket, or cracked head.</p>
Inadequate Performance	<p>Damaged or improper propeller.</p> <p>Excessive water in bilge area.</p> <p>Boat overloaded or improper distribution of load.</p> <p>Fouled or damaged hull bottom.</p>	<p>Inspect propeller, replace if required.</p> <p>Pump out bilge area. Inspect for cause of excess water.</p> <p>Reduce load or redistribute load.</p> <p>Inspect, clean, or repair as required.</p>

<i>PROBLEM</i>	<i>CAUSE</i>	<i>CORRECTION</i>
Vibration	Propeller bent or pitch out of true. Damaged propeller shaft. Loose engine mounting bolts. Engine out of alignment.	Inspect propeller, replace as required. Replace shaft. Inspect and tighten as required. See your engine manual.



Properly used and maintained, your boat will give you years of service and enjoyment. By keeping your boat “ship-shape”, you will be doing more than protecting your investment; you will also ensure good performance and safety on the water.

The first step in ensuring good performance is keeping your boat clean, particularly below the waterline where a build up of scum, algae, or other marine growth can rob you of performance and fuel efficiency.

NOTE: Before attempting to use a particular cleaning solution or method for cleaning, test the material to be cleaned in a hidden or inconspicuous area for possible adverse reactions.

DECK AND HULL CARE

IMPORTANT: Avoid walking on soiled fiberglass surfaces to prevent scratching and dulling of the finish.

Wire brushes, scouring pads, or other abrasive type materials/solutions should never be used on the deck or hull of your boat. They create small scratch marks that will collect marine growth and other foreign materials.

The finish on your boat is made of highly durable marine gelcoat and with proper care, will last for many years, retaining its lustrous appearance. Algae, forms of marine growth, and barnacles (in salt water) are extremely hard to remove once firmly attached to the bottom of your hull. To avoid attachment of barnacles or marine plant life, it is recommended you wash the bottom of your hull after every outing. In addition, it is a good idea to completely hose down the boat after use, especially in salt water areas.

Consult your Glastron dealer for deck and hull commercial cleaners and their use.

You may want to have the hull of your boat coated with an anti-fouling paint. Again, see your Glastron dealer for application and cost.

IMPORTANT: If your boat will be in water continuously for two or more weeks, **Glastron Boats recommends sealing the hull bottom with a high quality barrier coating.** Unsealed gelcoat may form water blisters. Repair of water blister damage is not covered under the Glastron Boats Warranty. Contact your Glastron dealer for further information, and help in selecting the proper coating for your boat.

Once your deck and hull have been cleaned, (except for heavy grime or oil, a mild detergent and water will suffice-DO NOT USE ABRASIVES) you are ready for a wax application to bring back the original sheen of your hull. If your deck and hull have oxidized (a light white milky film), you may want to use a rubbing compound before waxing. Ask your Glastron dealer to recommend a good commercial product.

⚠ WARNING

WARNING: Waxing your deck brings back luster but also makes the deck slippery!

It is a good idea to wax your boat at least twice a year. Keep the interior and exterior of your boat in nice condition, and inspect your boat regularly to keep minor problems from becoming major ones. REMEMBER, AN OLDER BOAT IN NEARLY NEW CONDITION RETAINS A HIGH RESALE VALUE.

Bottom Paint (Anti-fouling)

Anti-fouling bottom paint is designed to dissolve slowly to prevent marine growth. Therefore, the hull bottom should be repainted at the end of the boating season. Factors to take into consideration when selecting a protective bottom paint are: water temperature, pollution, salinity, current, and organic material in the water.

IMPORTANT: Consult with your Glastron dealer for recommended bottom paints and local laws that govern your area. Many states regulate the chemical content of bottom paints to meet environmental standards and regulations.

1. Scrub hull bottom with a bristled brush and solution of soap and water.

NOTE: Repainting hull bottom is not required after each scrubbing unless bare areas are visible in the bottom paint.

2. Sand entire bottom surface of boat.
3. Fair (smooth-out) all rough areas as required.
4. Clean bottom surface to remove all dust and foreign materials.
5. Make sure bottom surface is completely dry.
6. Apply new coat of bottom paint.

NOTE: Always follow manufacturer's procedures and recommendations concerning application of paint and drying time before putting your boat in the water.

Fiberglass Repair

Although your deck and hull have been designed to withstand normal use, it is inevitable that surfaces will become

scratched or chipped over a period of time. Superficial scratches present little problem since they can usually be rubbed out with a compound cleaner.

"Hairline cracks" or "spider webbing" may develop in the gelcoat surface of a hull or deck. This can be caused by weathering, impact, or other factors. Small blisters or gouges may also occur through normal wear. These do not affect the strength of the hull or deck and can easily be repaired by you or your Glastron dealer.

The affected area should be chipped or sanded away and a thin layer of color-matched gelcoat applied. This layer is then sanded smooth and buffed back to its original luster. Your Glastron dealer can obtain color-matched gelcoat and further instructions from the manufacturer.

Fiberglass hulls are tough but like hulls of any other materials, they can be damaged. A fiberglass hull has virtually no internal stresses. Thus, when a part is broken or punctured, the rest of the hull retains its shape. A severe blow will either be absorbed or result in a definite, localized break. In the case of a break of this nature, the boat should be returned to your Glastron dealer for repair.

You will need the following items for minor repairs:

- Gelcoat
- DDM (clear liquid catalyst)
- Putty knife or equivalent
- Razor blade
- Fine sandpaper (400 to 600 grade)
- Wax paper (piece big enough to cover repair)

⚠ WARNING

WARNING: Gelcoat and fiberglass resin are flammable; work in well ventilated area free from any and all fire hazards.

FOR MINOR REPAIRS FOLLOW THIS PROCEDURE

1. Clean the area to be repaired and clear it of wax and oil.
2. Thoroughly clean out nicks, chips and scratches.
3. Sand area to be repaired so gelcoat will bond.
4. IN A SEPARATE CONTAINER, MEASURE ONLY THE AMOUNT OF GELCOAT YOU NEED. Mix a 2% ratio of catalyst to the amount of gelcoat being used (a spoonful of gelcoat will require only a drop or two of catalyst).

NOTE: DO NOT pour any unused portions of the gelcoat/catalyst mixture back into either original container.

5. Apply gelcoat to area leaving a slight lift above the surface.
6. Cover with wax paper (lack of oxygen helps mixture set) and let set 20 to 30 minutes.
7. Remove wax paper and shave off excess gelcoat with a razor blade.
8. By the time the area is shaved smooth, you are ready to sand (Use 400 to 600 grade sandpaper, NO SUBSTITUTES.)
9. Rub or buff the fiberglass with automotive cleaner compound, then wax.

Some discoloration may occur if your boat has weathered. For your first attempt at repair, experiment on an area not normally visible. With a little experience, even the novice can repair a scratch with few, if any visible repair marks.

Hardware and Fittings

Chrome, stainless steel, and aluminum hardware should be cleaned with water and a cloth, followed with either an application of commercial aluminum or chrome cleaner. For excessively dirty or oily hardware, use alcohol. **AVOID THE USE OF DETERGENTS OR ABRASIVES WHEN CLEANING HARDWARE.**

Inspect all hardware and fittings to make sure they are secure. All screws, bolts, clamps, cleats, etc., must be tight.

UPHOLSTERY

Your boat's seats and vinyl upholstery should be kept as clean as the exterior finish to prolong life and beauty.

Seat Coverings & Vinyl

The seat coverings and vinyl trim are made of temperature resistant vinyl.

1. Always try to clean up spills quickly to prevent staining.
2. Clean dirt and smudges with mild soap and warm water. If necessary, scrub with a soft bristle brush to remove dirt from textured vinyl. Dry with a soft, lint-free cloth or towel.
3. MSG Final Finish Cleaner is recommended for cleaning your interior vinyl. It may be purchased from your local dealer.
4. Certain household cleaners, powdered abrasives, steel wool and industrial cleaners can cause damage and discoloration and are not recommended. Dry cleaning fluids and lacquer solvents should not be used as they will remove the printed pattern and gloss.

Waxes should be used with caution. Many contain dyes or solvents that can permanently damage the protective coating.

5. Periodic applications of a vinyl protection solution will help keep vinyl clean and pliable. 303 Protectant is recommended and may be purchased from your local dealer. Follow instructions provided by vinyl manufacturer. Check cleaning solution labels before using. **Do Not** use 409® cleaner or Armor All®.
6. Removable outside seat cushions should be placed inside when not in use.

Interior Fabrics

Treat the fabric upholstery the same as home fabric upholstery. Vacuum and shampoo to maintain upholstery clean and odor free. Spray with Lysol™ or other disinfectant to prevent the build-up of mildew.

WINDSHIELDS AND WINDOWS

IMPORTANT: Never use acetone, benzene, carbon tetrachloride, lacquer thinner, or similar type solvents. They penetrate the glass surfaces and cause hazing which will obstruct visibility.

Safety glass windows and windshields may be cleaned just like those in a car. Plastic windshields and port windows should be cleaned with clear water. After dirt is removed, use a plastic window cleaner and non-abrasive polish. Vibration may loosen windshield fasteners and braces during normal use. These should be checked periodically for tightness.

CARPETING

Exterior

Scrub indoor/outdoor carpeting with a brush using mild detergent and warm water, then thoroughly rinse with clear water. Allow carpet to dry completely before use. Apply a light coating of Scotch Guard® to protect against accidental spills.

Interior

Vacuuming and occasional carpet shampoo are recommended for extended life and appearance. Apply a light coating of Scotch Guard® to protect against accidental spills.

CANVAS

Convertible and bimini-tops are designed and intended to provide coverage of the helm seating areas from the sun. These tops are not a weather cover and will be damaged by accumulation of rain water. While these tops are intended to provide ample weather protection for the helm, the tops are not completely weather-tight like a winter storage cover. To prevent exterior helm seat cushions from getting wet, it is recommended that all removable exterior cushions be removed and properly stored when helm cover is installed.

Glastron does not warrant damage to vinyl tops that might occur when a boat is being towed on a trailer with the top up, and does not warrant shrinkage, mildew, or other normal deterioration.

Cleaning

IMPORTANT: Do Not use hot water, dry in an automatic dryer, dry clean or steam press canvas.

1. Wet down all canvas. Use a soft bristle brush and scrub with a mild detergent and water solution.
2. Use a mild solution of ammonia/water and scrub for heavy soil or mildew build-up. Be sure to rinse thoroughly.
3. Brush or sweep underside of the top. Spray with Lysol™ or other disinfectant to prevent mildew.

Care

1. Keep the top up in rain or when boat is not in use.
2. Lubricate zippers with paraffin, and snaps with petroleum jelly.
3. If a leak occurs along a canvas seam, rub with paraffin or apply a light coating of Scotch Guard®.
4. Air dry all canvas material before storing. Never store canvas while damp or wet, and provide proper ventilation to prevent mildew.
5. Avoid mooring under trees.
6. Never tow your boat with the top up.
7. When not in use, remove the top and store in the boot onboard your boat.



This section of your owner's manual will assist you in preparing your boat for prolonged storage. When cold weather has arrived, or a change in your boat's usage requires extended storage, we suggest you follow the guidelines contained within this section. For areas that do not require seasonal storage, Glastron Boats recommends a thorough annual inspection.

IMPORTANT: Consult your engine manual for specific instructions covering winterization of the engine. For recommended cleaning solutions and procedures referenced, see Section IV. Maintenance of your owner's manual.

REMOVING BOAT FROM WATER

If you do not store your boat on a trailer, it may be necessary to lift your boat out of the water. Consult with your dealer or marina operator when deciding how to remove your boat. Your boat has structural components designed to support the boat when it is being lifted. Your dealer or marina operator should have the knowledge and equipment to safely lift your boat.

Prior to lifting your boat, be sure to remove all water from the bilge and drain all water and waste tanks. Consult your dealer or marina operator for the proper cradle to support your boat while it is out of the water.

PRIOR TO STORAGE

Hull

1. Scrape off any barnacles or crusted marine growth.
2. Scrub the hull thoroughly to remove marine growth and scum.

3. Inspect the underwater gear and propellers for excessive wear or damage.
4. Remove the hull drain plug and store in a safe place.

Deck

1. Wash the deck, superstructure and cockpit.
2. Clean all deck hardware (i.e. cleats, rails, instruments, etc.) and apply a coat of metal polish or wax.
3. Clean the indoor/outdoor carpet.

ENGINE, SYSTEMS & COMPONENTS

1. Drain the engine block, heat exchangers and manifolds. (This may vary by engine model.)
2. Drain the outdrive and change lubricant. (Your Glastron dealer will perform No. 1 and No. 2 for a moderate fee.)

IMPORTANT: In regions where temperatures fall below freezing, all engine plugs must be removed before storing your boat for the winter. Failure to do so will seriously damage the engine. Freeze damage is not covered by the Glastron Warranty. Make sure your boat's engine is slightly bow up during the extended storage period.

Fuel System

Fill the fuel tank completely, or empty completely. Either method will minimize condensation. You may want to add a gasoline stabilizer solution to the fuel, if the tank is to remain full. Follow the product manufacturer's recommended procedure.

Engine Lubrication

1. Drain oil when engine is warm. This will ensure complete drainage of oil. If the engine oil contains sludge, use a flushing oil to clean away the residue. Refer to your engine manual.
2. Replace the engine oil filter.
3. Fill the crankcase(s) with the required quantity of recommended engine oil as specified in your engine manual.
4. Start the engine, and check for leaks.
5. Pour or spray fogging oil through the carburetor air intake. Continue to pour or spray fogging oil until the engine stops.
6. Clean and lubricate all linkage.
7. Spray the entire exterior surface of the engine with a rust and corrosion inhibitor.
8. Have the engine alignment checked and adjusted by a qualified marine technician.
9. Inspect all gaskets and seals, grease the U-joints, and change gear oil.
10. Remove the propeller. Clean and lubricate the prop shaft and check for damage.

Battery

1. Remove battery, check water level, and store away from freezing temperatures.

IMPORTANT: Battery should be stored in a cool dry place.

WARNING

WARNING: To prevent personal injury, wear goggles, rubber gloves and a protective apron when working with battery. Battery electrolyte can cause severe eye damage and burns to the skin. In case of spillage, wash area with a solution of baking soda and water.

2. Clean outside battery case, terminals, and battery clamps with a solution of baking soda and water.

NOTE: Do Not allow baking soda/water solution to enter the cells.

3. Lightly sand battery posts and clamps with fine grit emery cloth.
4. Apply a light coat of petroleum jelly to the cover end of the battery cables.
5. A monthly recharge or continuous trickle charge should be applied to the battery during storage.

Cooling System

To prevent corrosion damage, drain the cooling system before extended storage or when freezing weather threatens.

1. When draining the cooling system, make sure all plug openings are free of obstructions and marine growth.
2. Fill the cooling system with anti-freeze and fresh water to provide additional corrosion and freeze-up protection. Mix anti-freeze according to label directions for the lowest expected temperature.

Fresh Water System

1. Open all faucets. Use manual pump to empty water tank and intake lines.
2. Open all drains.
3. Pump to force all water from unit.
4. After tank is empty, add RV type antifreeze to prevent freezing.
5. Open all faucets. Use manual pump to force antifreeze through system to each faucet.
6. Close faucets.

Marine Sanitation Device (MSD)

Improper winterizing can cause your MSD to fail. In salt water environments, the toilet bowl should be filled with fresh water and allowed to stand for several days. This will ensure that any accumulated salt has sufficient time to dissolve. Consult the manufacturer's instruction manual for detailed winterization procedures.

Bilge Pump

The bilge pump on your boat must be drained to prevent damage if it is exposed to freezing temperatures. Pump as much water as possible out of the bilge. Then, turn on the pump for a few seconds to remove water from the pump.

NOTE: Running the pump dry for an extended period of time will damage the pump. Run pump only as long as necessary.

⚠ WARNING

EXPLOSION HAZARD! Waste in holding tank can form methane, an explosive gas. Keep vent open and clear of obstructions. Keep fire and flame away when maintaining sanitary system.

INTERIOR CLEANING

1. Scrub all interior surfaces including cupboards, cabinets and drawers.
2. Be sure to remove everything that can hold moisture and cause mildew. Remove and store OFF the boat, all cushions, mattresses, curtains, blankets and sheets, pillows, towels, and clothing.
3. If it is necessary to store cushions onboard:
 - Open all zippers and elevate cover away from the foam padding.
 - Place a small plastic bowl or other round blunt object inside the cushion to allow for adequate air circulation.
 - Seats that can be folded should be stored in the down position.
 - Use plastic seat covers to keep out dampness and protect against mildew.
4. Make sure the cabin is well ventilated.
5. Personal flotation devices (PFDs) and other safety equipment must be cleaned and dried. If left onboard, place them where air can circulate around them.

6. Clean and thoroughly dry the bilge area. Remove all rags, sponges, or other cleaning materials from bilge area.
7. Before storing your boat, make sure all interior areas are dry, including carpet, upholstery, bilge, cabinets, etc. Never cover a wet boat for extended periods. Allow the interior to air out for a few days prior to storage. Failure to dry boat's interior before storage may cause damage to the interior that is not covered under the boat's warranty.
8. If you store your boat outside, we recommend that you do not store with the canvas and bow set on. Cover with a storage cover, tarp or plastic (available from Glastron dealers)-especially if you live in an area of heavy snow. Whatever material you use for a cover, be sure the boat is properly ventilated.

NOTE: After cleaning, make sure everything is thoroughly dry and air can circulate freely throughout the inside of your boat.

IF YOU STORE YOUR BOAT ON A TRAILER

1. Loosen all tie downs to relieve the stress on the hull.
2. Place blocks under the axles if tires are to come in contact with damp ground.
3. Repack the trailer wheel bearings.
4. Store with the bow up, and remove the drain plug to allow for any excess water to drain.

RECOMMISSIONING

1. Inspect the fuel system and all associated equipment for proper connections, corrosion, leaks, or other damage. Always be alert for the odor of fuel vapors.

IMPORTANT: For detailed information concerning recommissioning of the engine, refer to your engine manual.

2. Clean battery terminal posts with a wire brush or steel wool before installing.
3. Check the charge on the battery. Recharge or replace if necessary.
4. Inspect all battery wiring. Repair or replace if necessary.
5. Attach the battery cables and tighten the cable clamps.

IMPORTANT: Do Not apply petroleum jelly or marine grade grease before connecting and tightening clamps.

6. Apply petroleum jelly or marine grade grease on posts and clamps to eliminate air pockets and acid build-up.
7. Coat the hull drain plug threads with petroleum jelly and reinstall.
8. Clean the bilge area.
9. Reinstall the exhaust drain plug.
10. Inspect all exhaust connections for carbon monoxide (CO) leakage. Adjust and repair as required.
11. Test the navigational lights and all other lighting onboard.
12. Inspect all wiring for fraying, wear, loose connections, and other damage.
13. Inspect all switches, controls, and other related equipment for proper operation.
14. Inspect all safety equipment for proper operation and physical condition.



Abaft	Toward the stern.	Athwart	Across.
Abeam	Amidships, at a right angle to the keel.	Aweigh	Off the bottom, said of an anchor.
Aboard	On, in, or into a boat.	Aye	Yes, while aboard a boat or ship. Means "I understand."
ABYC	American Boat and Yacht Council, Inc., the organization that sets voluntary safety and construction standards for small craft in the USA.	Bail (Bale)	To remove water from a boat by pump or bailer.
Adrift	Without motive power and without anchor or mooring.	Ballast	Heavy material such as iron, lead, or stone placed in the bottom of the vessel.
Afloat	On the water.	Beacon	A post or buoy placed over a shoal or bank to warn vessels, also a signal mark on land.
Aft	Describing the after section of a vessel, or things to the rear of amidships and near the stern.	Beam	Imaginary line amidships at right angles to keel of vessel. Also vessel's width amidships.
Aground	Touching bottom.	Bearing	The direction or point of the compass in which an object is seen.
Amidships	In the center, the center portion of a vessel.	Belay	To make fast to a cleat or belaying pin; to cancel an order.
Anchor	A forging or casting shaped to grip the sea bottom and, by means of a cable or rope, hold a boat in a desired position.	Below	Beneath, or under, the deck. One goes below when going down into the cabin.
Anchorage	A customary, suitable and (usually) designated harbor area in which vessels may anchor.	Bend	To fasten by means of a bend or knot.
Astern	Toward the stern. An object that is aft of a boat is said to be astern of the boat.	Berth	A position, as a place to sleep or in which a vessel maybe made fast; a margin of safety, as "a wide berth."

Bilge	The lower internal part of a boat's hull.	Certificate	Government paper, such as a boat's license.
Bollard	A strong post for holding lines fast.	Chart	A map of a body of water that contains piloting information.
Bow	The forward part or front of the boat.	Chine	The intersection of sides and bottom of a boat.
Breakers	Waves cresting as they reach shallow water, as at or on a beach.	Cleat	A piece of wood or metal with projecting ends to which lines are made fast.
Breakwater	A structure, usually stone or concrete, built to create a harbor or improve an existing one.	Clinker	A method of planking in which the lower edge of each strake overlaps the upper edge of the strake next below. (Also called lapstrake.)
Bulkhead	Vertical partition in a boat.	Coaming	A raised edge, as around part or all of a cockpit, that prevents sea water from entering the boat.
Burdened Vessel	Former term for the vessel which must stay clear of vessels with the right-of-way.	Coast Guard	The federal marine law enforcement and rescue agency in the US.
Calking (Caulking)	Forcing filler material into the seams of the planks in a boat's deck or sides, to make them watertight.	Cockpit	A well or sunken space in the afterdeck of a small boat for the use of the helmsman and crew.
Camber	The arch of a deck, sloping downward from the center toward the sides.	Companionway	A hatch or entrance, from deck to cabin.
Capsize	To turn over.	Compass	The instrument which shows the heading of a vessel.
Carburetor Backfire Flame Arrestor	Required equipment on all motorboats except outboards and diesels. Reduces chance of fire caused by backfires in internal combustion engines.	Cowls	Hooded openings used for ventilation.
Cardinal Points	The four main points of a compass; north, east, south, and west.	Cradle	A frame used to support a vessel on land.
Ceiling	The inside lining of the hull.		

Current	The movement of the water in a horizontal direction.	Dunnage	Mats, boughs, pieces of wood, or other loose materials placed under or among goods carried as cargo in the hold of a ship to keep them dry and to prevent their motion and chafing; cushioning or padding used in a shipping container to protect fragile articles against shock and breakage; baggage or personal effects.
Deadrise	The rise of the bottom of a midships frame from the keel to the bilge.	Ebb	An outgoing tide.
Deck	Any permanent covering over a compartment.	Estuary	An inlet or arm of the sea.
Deep-six	To discard or throw overboard.	Fathom	Six feet.
Depth Sounder	An electronic depth-finding instrument, measuring the time a sound wave takes to go from the vessel to the bottom and return, then displaying the result in feet, fathoms, or meters.	Fenders	Objects placed along the side of the boat to protect the hull from damage.
Dinghy	A small, open boat.	Flare	The outward spread of the boat's sides from the waterline to the rail at the bow. Also, a pyrotechnic signaling device that can indicate distress.
Displacement Hull	Type of hull that plows through the water even when more power is added.	Fore	Used to distinguish the forward part of a boat or things forward of amidships. It is the opposite of aft or after.
Dock	An enclosed or nearly enclosed water area; all the port installations; a place where vessels can moor, as a pier, wharf, or floating dock.	Forward	Toward the bow.
Documented Vessel	Vessel registered with the U.S. Coast Guard.	Frame	Ribs of the hull, extending from the keel to the highest continuous deck.
Dolphin	A small group of piles, in the water, generally used for mooring or as a channel marker.	Freeboard	The vertical distance measured on a boat's side from the waterline to the gunwale.
Draft	The depth of the vessel below the water line, measured vertically to the lowest part of the hull.	Galley	The kitchen area of a boat.
		Gimbals	Swivels used to keep equipment level.

Give-Way Vessel	The one which must stay clear of vessels which have the right-of-way.	Inland Rules	Rules of the road that apply to vessel operation in harbors and certain rivers, lakes, and inland waterways.
Grab Rail	A convenient grip, on a cabin top or along a companion ladder.	Intracoastal Waterways	(ICW): bays, rivers and canals along the coasts (such as Atlantic and Gulf of Mexico coasts), connected so that vessels may travel without going into the open sea.
Gunwale	The upper edge of a boat's side. (pronounced gunnel.)	Jetty	A structure, usually masonry, projecting out from the shore; a jetty may protect a harbor entrance.
Harbor	A safe anchorage, protected from most storms; may be natural or man-made, with breakwaters and jetties; a place for docking and loading.	Keel	The permanently positioned, fore-and-aft backbone member of a boat's hull.
Hatch	An opening in a boat's deck for persons or cargo to go below.	Knot	To bend a line. Also, a unit of speed equal to one nautical mile (6,076.10 feet) an hour.
Head	A marine toilet.	Launch	(1) To put a vessel into the water; (2) a small open powerboat, mainly used for transportation between a vessel and shore.
Headway	Forward motion of a vessel through the water.	Lee	The side opposite to that from which the wind blows.
Helm	The wheel or tiller by which a ship is steered.	Leeward	Situated on the side turned away from the wind. (Opposite of windward.)
Holding Tank	Storage tank for sewage, so that it will not be pumped overboard into the water.	Leeway	The amount a boat is carried sideways by the wind's force or current.
Hull	The body of a boat.	Limber Holes	Drainage holes in the bilge timbers of a vessel, allowing water to run to a low point for pumping out.
Hypothermia	A physical condition where the body loses heat faster than it can produce it.		
Inboard	More toward the center of a vessel; inside; a motor fitted inside the boat.		

List	(1) A continuous leaning to one side, often caused by an imbalance in stowage or a leak into one compartment; (2) A light list is a printed listing of aids to navigation, in geographical order, or inclining of a vessel toward the side.	Navigation	The art of conducting a ship from port to port.
LOA	Length over all; the maximum length of a vessel's hull, excluding projecting spars or rudder.	Nautical Mile	6076.12 feet, or 1852 meters, an international standard; the geographical mile, the length of one minute of latitude at the equator, is 6087.20 feet.
Locker	A storage place, a closet.	Nun Buoy	A conical, red buoy bearing an even number and marking the starboard side of a channel from seaward.
Log	A record or diary of a vessel's journey.	Oar	A long, wooden instrument with a flat blade at one end, used for propelling a boat.
Lubber's Line	A mark or permanent line on a compass that shows the course of the boat.	Outboard	(1) a propulsion unit for boats, attached at the transom; includes motor, drive shaft, and propeller; fuel tank and battery may be integral or installed separately in the boat; (2) outside or away from a vessel's hull; opposite of inboard.
Making Way	Making progress through the water.	Outdrive	A propulsion system for boats, with an inboard motor operating an exterior drive, with drive shaft, gears, and propeller; also called stern-drive and inboard/outboard.
Marina	A place, essentially a dock area, where small recreational craft are kept; usually floats or piers, as well as service facilities, are available.	Overall Length	The extreme length of a vessel, excluding spars or rigging fittings. See LOA.
MAYDAY	A radio distress call, from the French m'aidez (help me); SOS in Morse Code.	Painter	A rope attached to the bow of a boat for making it fast.
Mooring	Commonly, the anchor chain, buoy, pennant, etc., by which a boat is permanently anchored in one location.	PFD	Personal Flotation Device.
Motor	A source of mechanical power.		
Motorboat	Any watercraft 65 feet or less in length propelled by machinery, whether or not such machinery is the principal source of propulsion.		

Pier	A structure, usually wood or masonry, extending into the water, used as a landing place for boats and ships.	Scope	The length of the anchor rope or chain. 6 to 1 scope means that the length of the anchor rope from the boat to the anchor is 6 times the depth of the water.
Pile	A vertical wooden or concrete pole, driven into the bottom; may be a support for a pier or floats; also used for mooring.	Scupper	A hole allowing water to run off the deck.
Piling	A structure of piles.	Sea Anchor	A floating canvas cone, held open by wire rings, with an opening in the smaller end, and a rope bridle at the larger end attached to a line leading to the vessel; used in storm conditions to (a) keep the bow of the boat to the wind, and (b) slow downwind drift of the boat.
Pitch	(1) The up and down movement as the bow and stern rise and fall due to wave action; (2) The theoretical distance advanced by a propeller in one revolution.	Seacock	A thru-hull valve, a shut-off on a plumbing or drain pipe between the vessel's interior and the sea.
Planning Hull	Type of hull that is shaped to lift out of the water at high speed and ride on the surface.	Slip	(1) a berth for a boat between two piers or floats; (2) The percentage difference between the theoretical and the actual distance that a propeller advances when turning in water under load.
Port	The left side of a boat when you are facing the bow, also a destination or harbor.	Sole	The cabin or cockpit floor.
Privileged Vessel	Former term for the vessel with the right-of-way.	Spar Buoy	A channel marker that looks like a tall, slender pole.
Propeller	Wheel or screw. Mechanism that pushes water aft to propel the boat.	Stand-On Vessel	The vessel with the right-of-way.
Rigging	The general term for all lines(ropes) of a vessel.	Starboard	The right side of a boat when you are facing the bow.
Roll	The sideward motion of a boat caused by wind or waves.	Stern	The after end or back of the boat.
Rules of the Road	The nautical traffic rules for preventing collisions on the water.		

Stow	To store items neatly and securely.	Vessel	Every kind of watercraft, other than a seaplane on the water, capable of being used as a means of transportation on water.
Strake	Planks running fore and aft on the outside of a vessel.	VHF Radio	A Very High Frequency electronic communications and direction finding system.
Taffrail	The rail around a boat's stern.	Wake	Moving waves, created by vessel motion. Track or path that a boat leaves behind it, when moving across the water.
Tide	The alternate rise and fall of waters caused by the gravitational attraction of moon or sun.	Wash	The loose or broken water left behind a vessel as it moves along; the surging action of waves.
Topsides	(1) The sides of a vessel above the waterline; (2) On deck as opposed to below deck.	Waterline	The intersection of a vessel's hull and the water's surface; the line separating the bottom paint and the topsides.
Transom	The transverse planking which forms the afterend of a small, square-ended boat. (Outboard motors are usually attached to a transom.)	Way	Movement of a vessel through the water. Technically it is underway when not at anchor, aground, or made fast to the shore. The common usage is interpreted as progress through the water. Headway when going forward and Sternway when it is going backwards.
Trim	To arrange weights in a vessel in such a manner as to obtain desired draft at bow and stern.	Well	Area at the rear of a boat where the motor may be located.
Trimaran	Boat with three hulls, the center one is the largest.	Wharf	A structure, parallel to the shore, for docking vessels.
Unbend	To cast-off or untie.	Wheel	(1) The steering wheel; (2) the propeller.
Underway	Vessel in motion, i.e., when not moored, at anchor or aground.		
USPS	United States Power Squadron, a private membership organization that specializes in boating education and good boating practices.		

- Whistle Signal** A standard communication signal between boats, to indicate change of course, danger, or other situations.
- Windward** Situated on the side closest to the wind. (Opposite of leeward.)
- Yaw** To swing or steer off course, as when running with a quartering sea.

GLASTRON

WARRANTY TRANSFER APPLICATION

For a transfer fee of \$250, the Second Retail Purchaser only may obtain any unexpired 2 year component/5 year structural coverage on the boat available to the First Retail Purchaser, subject to the other terms, limitations, and exclusions of the Glastron Limited Warranty.

Written inspection by a current Glastron dealer or an authorized Glastron representative must accompany the Warranty Transfer Application form (attached below). The Warranty Transfer Application form must be received by Glastron Boats within 30 days of purchase by Second Retail Purchaser. Please complete the application and return to the following address:

Glastron Boats Warranty Transfer Center
700 West River Road
Little Falls, MN 56345

NOTE: Upon approval by Glastron Boats, you will receive confirmation of transfer.

_____ Cut Here _____

Glastron Boats

GLASTRON

Please transfer the remainder of the 2 year component/5 year structural coverage for the boat described herein to the person listed below. A check or money order is enclosed for \$250 made payable to Glastron Boats.

OWNER'S NAME _____ DATE OF REQUEST _____

STREET ADDRESS _____

CITY _____ STATE _____ ZIP _____

HOME PHONE _____ BUSINESS PHONE _____

BOAT SERIAL NUMBER _____ BOAT YEAR _____

BOAT MODEL _____

SIGNATURE OF SECOND RETAIL PURCHASER _____

BOAT TRANSFER INSPECTION DATE _____

INSPECTED BY _____

GLASTRON LIMITED WARRANTY

Glastron Boats warrants to you, the first retail purchaser of a new Glastron boat bought from a factory authorized North American dealer, that it will repair or replace defects in materials or workmanship within the applicable Warranty Periods, subject to the "What This Warranty Does NOT Cover" section set forth below. The applicable Warranty Period runs from the date of delivery to the first retail customer provided that the boat is delivered within twelve (12) months from the date of manufacture. For boats delivered more than twelve (12) months after the date of manufacture, coverage will run from the date of manufacture and the first retail purchaser will be entitled to the coverage remaining under the Warranty Periods. All warranties run concurrently.

Non-structural parts and components: Two (2) year Warranty Period.

Structural defects in the hull: Five (5) year Warranty Period.

Your sole and exclusive remedy is the repair or replacement, at Glastron's sole option, of parts and components covered by this warranty.

This Glastron boat, including any alleged defective part, must be returned to an authorized Glastron dealer within the applicable warranty period to obtain warranty service. The Glastron dealer will carry out the warranty procedures on the owner's behalf. All warranty work will be performed at an authorized dealer, or at another repair facility that Glastron selects. The owner is responsible for the expense associated with transporting the boat to and from the repair facility.

This warranty extends only to the first retail purchaser. Coverage remaining under the Warranty Periods may be transferred to a second owner upon written request to Glastron within 15 days of purchase of the used boat. Proof of purchase date is required. The warranty may only be transferred **once**.

An action for breach of warranty shall be barred unless it is commenced within four (4) years from the date the cause of action accrues. An action for breach of any duty or obligation to repair or replace shall be barred unless it is commenced within one year from the date the cause of action accrues regardless of the time remaining in the Warranty Period.

This Warranty DOES NOT COVER:

1. A boat purchased from any party other than an authorized Glastron dealer.
2. A boat, including its components that has been altered or modified so as to adversely affect its operation, performance or durability.
3. Engines, outdrive, controls, propellers, batteries, appliances and other equipment or accessories that are not manufactured by Glastron, whether or not warranted by other manufacturers.
4. Gelcoat finishes (including blistering and osmotic blistering, cracking crazing or discoloration), mirrors, window glass, varnishes, paints, fabrics, chromium plated and stainless steel finishes, because of the varying effects resulting from different climatic and use conditions.
5. The cost of removal or re-instatement of parts or disassembly of units to repair or replace components covered by this warranty.
6. Any boat which has been misused, used in a negligent manner, used for racing, used for rental, charter, military or other commercial purposes, used without normal maintenance, operated contrary to any instruction furnished by Glastron, or operated in violation of any Federal, State, Coast Guard or other governmental agency laws, rules or regulations.
7. Any representation relating to speed, range, fuel consumption or other estimated performance characteristic.
8. Loss of time, inconvenience, boat payments, retail charges, improper lifting or trailering, travel expense, loss of use, in-and-out-of-water charges, towing and storage charges, loss of or damage to personal property, or other remedies not specifically allowed.
9. Dealer preparation, cleaning, final adjustments and alignments in preparing the boat for delivery or commissioning.
10. Leakage around windshield, hatches or other designed openings.
11. Fit and adjustment of exterior canvas tops, enclosures, and weather covers.
12. Sacrificial deterioration of anti-fouling paint or zinc anodes.

Remedy under this warranty is expressly limited to repair or replacement of defects in materials or workmanship, **and does not include incidental or consequential damages** that are specifically **DISCLAIMED**. Note: SOME STATES DO NOT ALLOW THE EXCLUSION OR LIMITATION OF INCIDENTAL OR CONSEQUENTIAL DAMAGES, SO THE ABOVE LIMITATION OR EXCLUSION MAY NOT APPLY TO YOU. The express limited warranty described above is exclusive. **IMPLIED WARRANTIES** are **LIMITED IN THEIR DURATION TO ONE (1) YEAR FROM THE DATE OF PURCHASE**. ALL IMPLIED WARRANTIES, if any, INCLUDING **MERCHANTABILITY and FITNESS FOR A PARTICULAR PURPOSE ARE DISCLAIMED** IN THEIR ENTIRETY AFTER ONE (1) YEAR FROM THE DATE OF PURCHASE. There are no warranties that extend beyond the description on the face hereof. **NOTE:** SOME STATES DO NOT ALLOW LIMITATION ON HOW LONG AN IMPLIED WARRANTY LASTS, SO THE ABOVE LIMITATION MAY NOT APPLY TO YOU. THIS WARRANTY GIVES YOU SPECIFIC LEGAL RIGHTS THAT VARY FROM STATE TO STATE.

This document contains the entire warranty given by Glastron. Glastron does not authorize any person or persons, including Glastron dealers, to change the terms of this express limited warranty, which is Glastron's only warranty. Glastron reserves the right to change or improve the design or manufacture of Glastron boats without obligation to modify any boat previously manufactured.

Glastron Boats

A Genmar Company

P.O. Box 460 • Little Falls, MN 56345 • 820-632-8895

<https://www.boat-manuals.com/>