

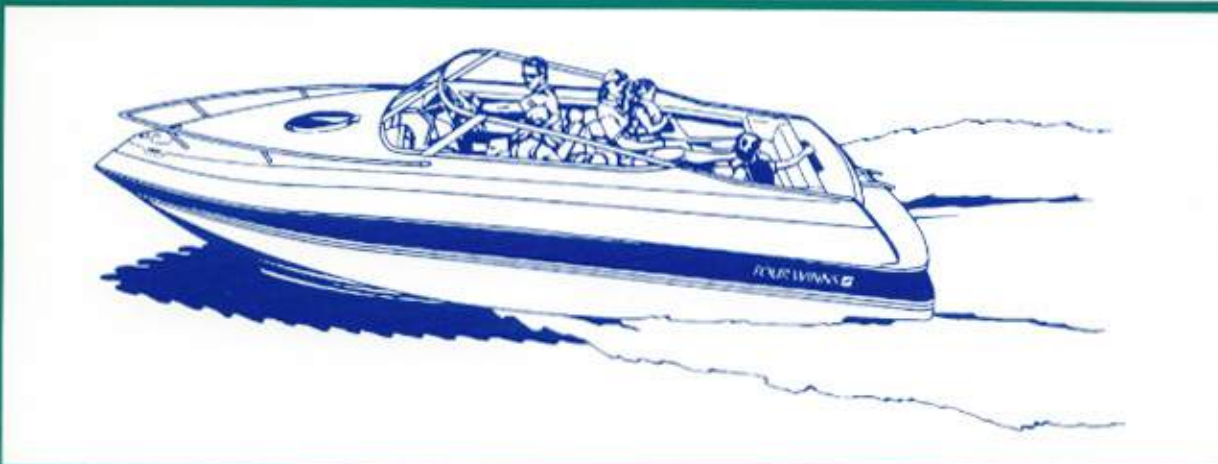

FOUR WINNS

SPORT BOAT

OWNERS MANUAL





PREFACE

This manual will acquaint you with the use and maintenance of your new Four Winns boat. This manual also provides special information critical to the safety of the passengers, and longevity of the equipment. The information on the following page lists the conventions used to increase the visibility of these important messages. Also included with this manual is the "Boating Basics, A Guide to Responsible Boating". This publication covers all the boating basics and should be read along with your Four Winns Owners Manual before operating your boat. Review this information in detail.

Four Winns continually strives to improve its products. Unit specifications, including standard and optional equipment are constantly being modified. Equipment availability is also subject to change. The most current and accurate information available at the time of publication is included in this manual. Some variation in equipment, description, location, and details can result.

The information in this manual focuses upon the equipment designed and manufactured by Four Winns on specific models. When appropriate, please utilize the information pertinent to your specific boat model.

Equipment such as engines, and other accessories are manufactured by others. The information provided in this manual is intended to be used in conjunction with the information provided by the manufacturers of this equipment. All information available at the time of manufacture has been included with your owners packet.

Read this manual carefully before operating your new boat. Many instructions may require direct performance of the activity to fully understand the correct method. If you choose to read this manual at home, remember to take it to the boat with you.

Your Four Winns dealer knows your boat best and is interested in your complete satisfaction. Return to him for service or other assistance. If you find it necessary to contact Four Winns directly, please write the office listed below. Be sure to include the boat model, serial number, your daytime telephone number, and specifics of the information desired.

This manual should be considered part of the boat. Should you sell the boat, pass this manual on to the new owner. Take special care of this manual. Certain information in this manual may not be available in a replacement manual.

Thank you for joining the Four Winns family. We appreciate your purchase and welcome the opportunity to demonstrate our commitment to you.

**Four Winns Customer Service Department
925 Frisbie Street
Cadillac, Michigan 49601
616-775-1343**

© Four Winns Boats 1995. All Rights Reserved.



WARNING CONVENTIONS

This manual contains instructions critical to the safety of those aboard or the longevity of the equipment. The conventions below have been adopted to increase the visibility of this information throughout the manual.

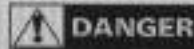

This is used to indicate the presence of a hazard which **WILL** cause **SEVERE** injury or death if the warning is ignored.

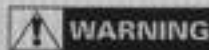

This is used to indicate the presence of a hazard which **CAN** cause **SEVERE** injury or death if the warning is ignored.

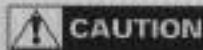

This is used to indicate the presence of a hazard which **WILL** or **CAN** cause **MINOR** personal injury or property damage if the warning is ignored.

NOTICE

This is used to notify people of installation, operation, or maintenance information which is important but not hazard-related.

The following pages illustrate the locations of various warning labels, capacity label and other stickers on your Four Winns boat.

CAPACITY LABEL AND OTHER STICKER LOCATIONS

The NMMA Capacity label and various warning stickers are placed at different locations on each model for your safety. Additional warnings for fuel leakage, operating the blower, and other important information will be imprinted or located on the dash. Many of these stickers and labels are not required by the U.S. Coast Guard but are important to ensure the safe operation of your Four Winns boat. In addition, the Hull Identification Number is molded into the gel coat below the deck-hull joint in the starboard aft corner.

Below are letters corresponding to the various locations for each item on the drawings.

- | | |
|-------------------------|--------------------------|
| (A) NMMA Certified | (E) Ski Tow Warning |
| (B) Capacity Label | (F) Ladder Warning |
| (C) Procedure Checklist | (G) Armorcote Sticker |
| (D) Equipment Checklist | (H) Winning Edge Sticker |

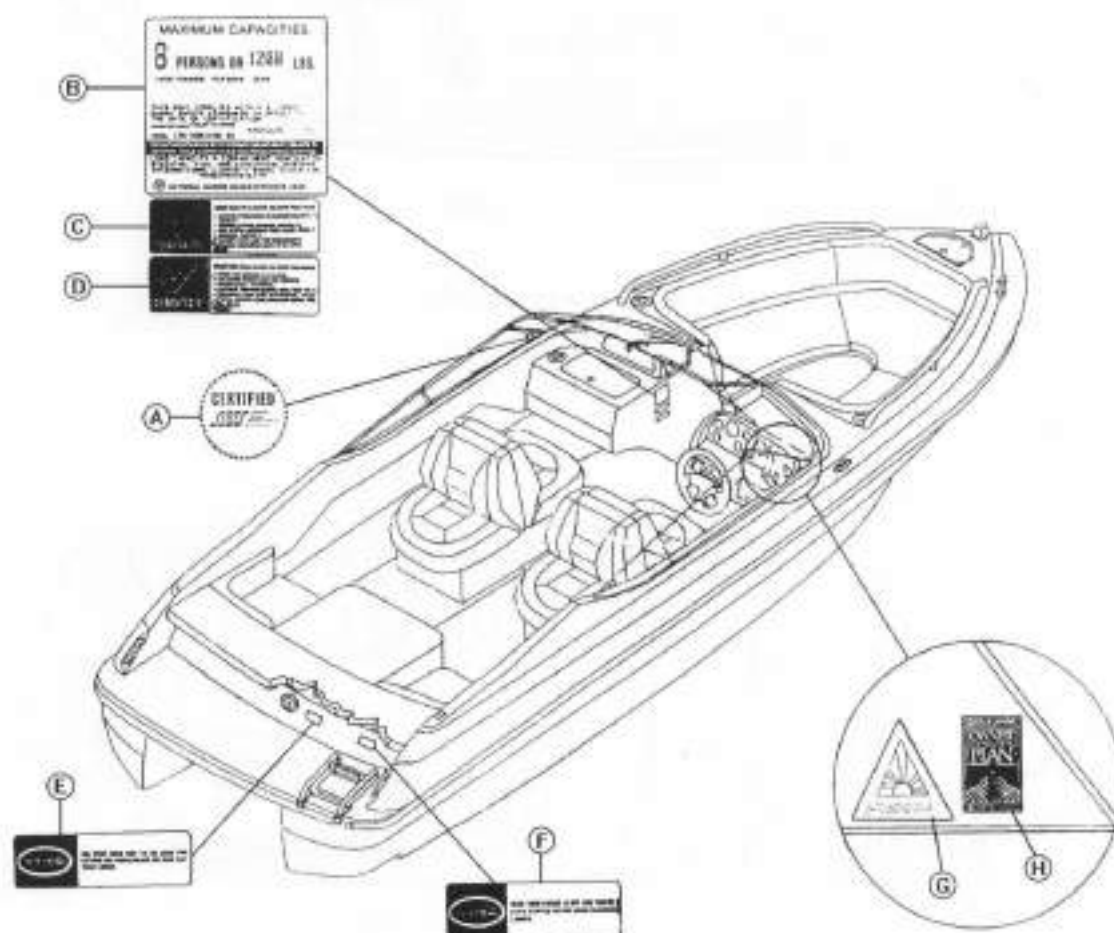

Figure 1: Horizon Models



- (A) NMMA Certified
- (B) Capacity Label
- (C) Procedure Checklist
- (D) Equipment Checklist

- (E) Ski Tow Warning
- (F) Ladder Warning
- (G) Armorcote Sticker
- (H) Winning Edge Sticker

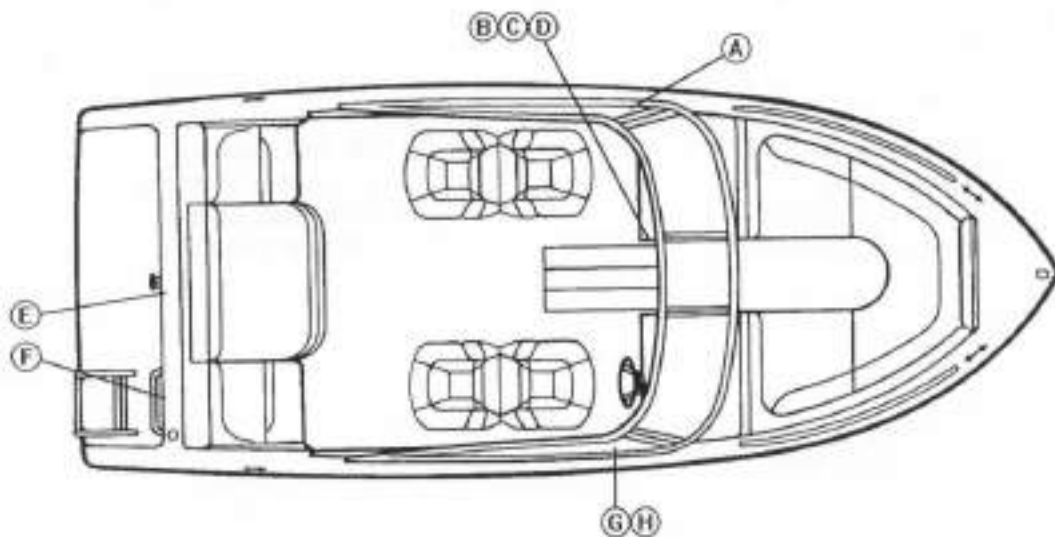

Figure 2: Freedom Model

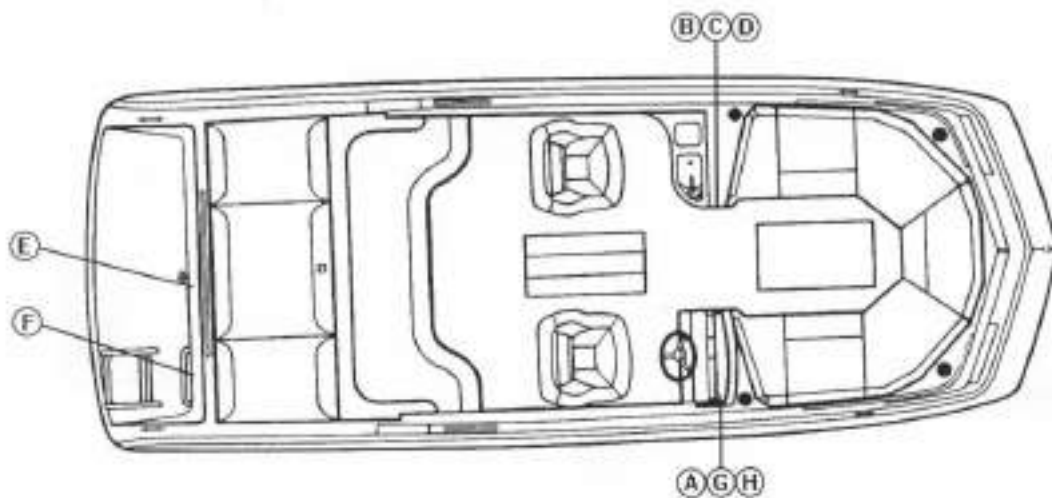

Figure 3: Candia Models



- (A) NMMA Certified
- (B) Capacity Label
- (C) Procedure Checklist
- (D) Equipment Checklist

- (E) Ski Tow Warning
- (F) Ladder Warning
- (G) Armorcote Sticker
- (H) Winning Edge Sticker

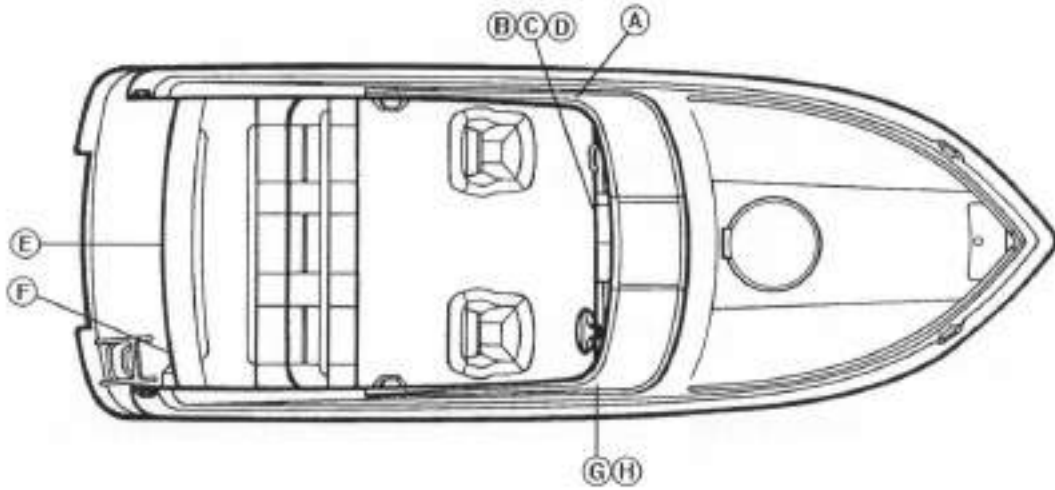

Figure 4: Sundowner Models



TABLE OF CONTENTS

WARRANTY AND SERVICE	1
A - 1 FOUR WINNS WARRANTY POLICY	1
A - 2 HULL STRUCTURE WARRANTY	1
A - 3 WARRANTY REGISTRATION	1
A - 4 TRANSFER OF WARRANTY	1
A - 5 PRE-OWNED UNIT REGISTRATION	1
A - 6 INSURANCE COVERAGE	2
A - 7 SERIAL NUMBER RECORD	2
A - 8 PRE-DELIVERY SERVICE	2
A - 9 REPLACEMENT PARTS	2
A - 10 CUSTOMER SATISFACTION SURVEY	2
A - 11 WINN GEAR	2
ENGINES AND INSTRUMENTATION	1
B - 1 GENERAL	1
B - 2 ENGINE EXHAUST	1
B - 3 ENGINES	2
B - 4 PROPELLERS	2
A. Diameter	2
B. Pitch	2
C. Prop Slip	2
B - 5 RUNNING ANGLE & POWER TRIM/TILT	3
A. Power Trim	3
B. Power Tilt	3
B - 6 TRIM TABS	4
A. Control Listing	4
B. Induce Planing & Control Trim Angle	5
C. Trim Tab Maintenance	5
B - 7 ENGINE INSTRUMENTATION	5
A. Tachometer	6
B. Speedometer	6
C. Temperature Gauge	7
D. Oil Pressure Gauge	7
E. Water Pressure Gauge	7
F. Voltmeter	7
G. Fuel Gauge	7
H. Power Trim Gauge	7
I. Depth Sounder	7
J. Ignition Switch	8
K. Emergency Ignition Shut-Off	8
L. Engine Hour Meter	8
M. Alarm Systems	8
N. Instrument Maintenance	9



CONTROL SYSTEMS	1
C - 1 GENERAL	1
C - 2 CONTROL OPERATION	1
A. Standard Engines	1
B. Multi-port Fuel Injected Engines (EFI)	1
C - 3 NEUTRAL SAFETY SWITCH	1
C - 4 CONTROL SYSTEM MAINTENANCE	2
STEERING SYSTEMS	1
D - 1 GENERAL	1
A. Rotary Steering	1
B. Tilt Steering	1
C. Power Steering	1
D. Hydraulic Steering	2
D - 2 PROPELLER TORQUE	2
D - 3 STEERING SYSTEM MAINTENANCE	3
A. General	3
B. Rotary System Maintenance	3
C. Hydraulic System Maintenance	3
D. Winter Storage	3
ELECTRICAL SYSTEMS	1
E - 1 GENERAL	1
E - 2 BATTERY SYSTEM	1
A. Single Battery System	1
B. Dual Battery System	1
C. Battery Switch Operation	2
E - 3 12 VOLT ELECTRICAL EQUIPMENT	3
A. Helm Equipment	3
B. Installation of Additional 12 Volt Equipment	4
C. Interior Equipment	4
D. Fish and Ski Option	4
E - 4 ELECTRICAL SYSTEM MAINTENANCE	4
A. Battery Maintenance	4
B. Electrical Wiring Maintenance	5
E - 5 STRAY CURRENT CORROSION	5
A. General	5
B. Galvanic Corrosion	5
C. Corrosion Prevention	5
FUEL SYSTEMS	1
F - 1 GASOLINE FUEL SYSTEMS	1
A. System Testing	1
B. Fuel Fills	1
C. Anti-Syphon Valves	2
D. Fuel Gauge	2
E. Fuel Senders	2
F. Fuel Filters	3
G. Use and Maintenance	3



F - 2	FUEL STANDARDS	3
	A. Problems With Alcohol in Gasoline	4
	B. Recommendations	4
F - 2	FUELING INSTRUCTIONS	4
WATER AND WASTE SYSTEMS		1
G - 1	GENERAL	1
G - 2	DISINFECTING THE WATER SYSTEM	1
G - 3	FRESH WATER SYSTEMS	2
	A. Cockpit Galley or Sink	2
	B. Transom Washdown	2
G - 4	GREY WATER SYSTEM	3
G - 5	HEADS	3
	A. Candia Head (Sunsport Models Only)	3
	B. Pump Out Option	3
G - 6	LIVEWELL	4
G - 7	SYSTEM MAINTENANCE	5
	A. Clean Vents and Screens	5
	B. Winterizing the Water System	5
VENTILATION AND DRAINAGE SYSTEMS		1
H - 1	ENGINE COMPARTMENT VENTILATION	1
	A. Gravity Ventilation System	1
	B. Forced Air Ventilation	1
	C. Engine Ventilation System Maintenance	1
H - 2	CABIN VENTILATION	1
H - 3	HULL DRAINAGE SYSTEMS	2
	A. Transom Drain	2
	B. Bilge Pumps	2
	C. Liner Drains	2
	D. Bilge Compartment Drainage	2
H - 4	CARBON MONOXIDE	2
	A. Definition of Carbon Monoxide	3
	B. Properties and Characteristics of Carbon Monoxide	3
	C. What Makes Carbon Monoxide	3
	D. How a Person is Affected by Carbon Monoxide	3
	E. Effects of Carbon Monoxide	3
	F. Symptoms	4
	G. Treatment (Evacuate, Ventilate, Investigate, Take Corrective Action)	4
	H. Inspection	4
	I. Operation	4
	J. Boathouses, Sea Walls and Other Boats	4
	K. Backdrafting (Station Wagon Effect)	5
	L. Cabin Appliances	6
	M. Ventilation of Accomodation Spaces	6
	N. Altitude and Sea Conditions	6
	O. Portable Generator Sets	6
	P. Maintenance - Engine Performance	6
	Q. Maintenance - External Conditions	7
	R. CO Detection Systems	7



INTERIOR EQUIPMENT	1
I - 1 BUTANE STOVE	1
I - 2 GLOVEBOX	1
I - 3 IN-DASH COOLER	1
I - 4 ICE BOX	1
I - 5 REFRIGERATOR	1
I - 6 STEREO	2
I - 7 SL PACKAGE	2
EXTERIOR AND SAFETY EQUIPMENT	1
J - 1 RAILS & DECK HARDWARE	1
A. Rails	1
B. Cleats	1
C. Transom Ski Tow Ring	1
D. Ski Pylon - Outboard Models	1
E. Anchor Locker	1
F. Maintenance	2
J - 2 WINDSHIELDS	2
A. Windshields (Except Candia Models)	2
B. Venturi and Console Windshields	2
J - 3 COMPANIONWAY & DECK HATCH	2
A. Companionway	2
B. Deck Hatch	3
C. Acrylic Maintenance	3
J - 4 SWIM PLATFORM	4
J - 5 BOW ROLLER	5
J - 6 ANCHOR	5
J - 7 NAVIGATIONAL EQUIPMENT	5
A. Compass	5
B. Depth Sounder	5
J - 8 FISHFINDER	6
J - 9 SPOTLIGHT	6
J - 10 FIRE EXTINGUISHER SYSTEM	6
UPHOLSTERY	1
K - 1 INTERIOR SEATING	1
A. Cabin Tables	1
B. V-berth Filler Cushions	1
C. Settee Cushions	1
K - 2 EXTERIOR SEATING	1
A. Bow Seating	1
B. Loungers	2
C. Bucket Seats	2
D. Stern (Jump) Seats	2
E. Outboard and Fish & Ski Seating	3
F. Top Storage	3
G. Motor Hood with Table Option	3
H. Wrap Around Seat (214 Candia Only)	3
I. Sunsport Interior	4
J. Bow Fishing Chair	4



K - 3	INTERIOR UPHOLSTERY CARE	4
K - 4	EXTERIOR UPHOLSTERY CARE	5
K - 5	REPLACEMENT UPHOLSTERY	6
K - 6	CARPET CARE	6
	A. Interior and Exterior Carpet	6
	B. Cleaning and Maintenance	6
	C. Stain Removal	6
WEATHER COVERS		1
L - 1	GENERAL INFORMATION	1
	A. Convertible Top (Suntop)	1
	B. Side Curtains	2
	C. Aft Curtain	2
	D. Forward Cover	2
	E. Bimini Top (Horizon & Sundowner)	2
	F. Bimini Camper	3
	G. Candia Bimini Top	3
	H. Cockpit Cover	4
	I. Mooring Cover	4
L - 2	TRAILERING	4
L - 3	WINTER STORAGE	4
L - 4	MAINTENANCE	4
L - 5	CARBON MONOXIDE	5
FIBERGLASS AND HULL INFORMATION		1
M - 1	HULL DESIGN INFORMATION	1
	A. Stable-Vee Hull Design	1
	B. Deep V-Hull Design	1
M - 2	FIBERGLASS CONSTRUCTION	1
M - 3	EQUIPMENT INSTALLATION	1
M - 4	FIBERGLASS CARE & MAINTENANCE	2
	A. General Maintenance	2
	B. Weathering Effects on Gel Coat	3
	C. Stains	4
M - 5	FIBERGLASS REPAIRS	4
	A. Scratches	5
	B. Gouges, Cracks, & Blisters	5
	C. Osmotic Blistering	6
M - 6	ANTI-FOULING PAINT	6
M - 7	HULL SUPPORT	7
WOODWORK AND COMPOSITES		1
N - 1	TEAK	1
N - 2	HIGH-PRESSURE LAMINATE CARE	1
N - 3	ASH	1
N - 4	STAR BOARD	1
N - 5	MAHOGANY	2



GENERAL MAINTENANCE	1
O - 1 WINTERIZATION	1
A. Prior to Lifting for Winter Layup	1
B. After Lifting	1
C. Prior to Winter Storage	2
O - 2 ENGINE FLUSH OUT	2
O - 3 GENERAL MAINTENANCE SCHEDULE	3
TRAILERS	1
P - 1 GENERAL TRAILER INFORMATION	1
A. Regulations	1
B. Load Carrying Capacity	1
C. Hitches	1
P - 2 TRAILER COMPONENTS	2
A. Bunk Supports	2
B. Tongue	2
C. Swivel Jack	3
D. Coupling Assembly	3
E. Surge Brakes	4
F. Winch	4
G. Wheels	5
H. Spare Tire Carrier	5
I. Lights	6
J. Tie-downs	6
P - 3 OPERATION	7
A. Hitching Trailers	7
B. Backing Up	8
P - 4 TRAILERING	8
A. Checklist	8
B. Tactics	9
P - 5 MAINTENANCE	9
A. Care of Exterior Finish	9
B. Bunks	10
C. Swivel Jack	10
D. Brake Actuator & Coupling Assembly	10
E. Winch	10
F. Lights	10
G. Tie-downs	10
H. Wheels	10
I. Brakes	11
J. Bearings	11
P - 6 AXLE INSPECTION & REPAIRS	11
A. Removal of Hub	11
B. Bearing/Seal Inspection and Replacement	12
C. Hub Reinstallation	12
OPERATION	1
Q - 1 GENERAL	1
Q - 2 COMPONENT SYSTEMS	1
Q - 3 SAFETY EQUIPMENT	1



Q - 4	PASSENGER SAFETY	1
Q - 5	RULES OF THE ROAD	1
Q - 6	LIGHTNING	1
Q - 7	DRINKING AND DRIVING	2
Q - 8	PRE-CRUISE SYSTEM CHECK	2
	A. Before Starting The Engines	2
	B. After Starting The Engine	2
Q - 9	ENGINE OPERATIONAL PROCEDURES	3
	A. Before Starting	3
	B. Cold Engine Start	3
	C. Warm Engine Starting	3
	D. Shifting and Control Speed	4
	E. Stopping Engine	4
Q - 10	GROUNDING AND TOWING	5
Q - 11	BOATING EDUCATION	5
	A. Boating Courses	5
	B. Boating Manuals or Literature	5
	C. Charts and Maps	6
Q - 12	GLOSSARY	6
FUEL LOG		1
SERVICE LOG		1
SERVICE INFORMATION		1
ELECTRICAL SCHEMATICS		1



WARRANTY AND SERVICE

A - 1 FOUR WINNS WARRANTY POLICY

The Four Winns Winning Edge™ Owner Protection Plan, provides the new Four Winns purchaser with one of the most comprehensive corporate commitments in the marine industry today. The Four Winns Owner Protection Plan, defines the warranty coverage on all units manufactured by Four Winns. It thoroughly describes the warranty policies and those procedures to be followed to obtain warranty coverage. Review the Four Winns Owner Protection Plan and limited warranty statements carefully.

All engines utilized in the Four Winns product are warranted by the engine manufacturer. Your Four Winns dealer is authorized to repair your engines and will work closely with the manufacturer to resolve any problems you have.

A - 2 HULL STRUCTURE WARRANTY

Each unit manufactured by Four Winns is encompassed by a separate warranty providing specific coverage on the hull structure. The Four Winns Owner Protection Plan thoroughly describes this coverage.

A - 3 WARRANTY REGISTRATION

A Four Winns Warranty Registration Card is attached to the Four Winns Owner Protection Plan statement. Your Four Winns Dealer is responsible for completing and mailing the warranty card at the time of purchase. This is the sole basis for establishing proof of ownership of the boat and trailer and corresponding warranty validation. Registration of the boat and engines with the manufacturer is required by the Federal Boat Safety Act of 1971.

Other equipment manufacturers also require that their products be registered with the respective companies. These warranty registration cards are provided with this manual.

A - 4 TRANSFER OF WARRANTY

Four Winns confidence in the product and our warranty commitments can extend long after the original purchaser may choose to move on to a new boat. Four Winns Limited Warranty coverage and Extended Protection Plan, when applicable, are transferable to successive owners of the boat. Registration of the second or successive owners is required. The Four Winns Owner Protection Plan thoroughly describes the action required to transfer warranty coverage.

A - 5 PRE-OWNED UNIT REGISTRATION

Section A-4 Transfer of Warranty discussed the need to properly register the purchase of a pre-owned boat with Four Winns to transfer applicable warranty coverage.

Purchasers of all Pre-Owned Four Winns models are encouraged to register ownership with Four Winns. To register ownership of a "Pre-Owned Four Winns boat," provide Four Winns with your name, address, daytime phone number, purchase date, and hull serial number of the boat purchased.

If you wish to transfer warranty or an extended service plan coverage, be sure to include a check to cover the necessary fees.

The hull serial number is embossed into the starboard side of the transom. The trailer serial number is imprinted on an identification plate affixed to the trailer frame.

Registration of a Pre-Owned Four Winns boat does not extend or in any way affect or modify the specific terms of the Four Winns Owner Protection Plan or Limited Warranties.

We provide this service to the purchasers of Pre-Owned Four Winns boats in the interest of better boating. Four Winns welcomes every purchaser of a Four Winns boat, new or used, to our family.



A - 6 INSURANCE COVERAGE

One of your responsibilities as a new boat owner is to acquire proper insurance protection. Insurance should include comprehensive and general liability coverage appropriate to your financial needs. Please contact your local agent for assistance on insurance coverage.

A - 7 SERIAL NUMBER RECORD

The manufacturer, model, and serial number of major components are recorded during the assembly of each Four Winns boat. Two copies of this completed form are included at the end of this section. One copy should be removed and kept by the dealer in his records. This can assist the dealer in processing warranty claims, or obtaining necessary information. The second copy should be kept in this owners manual.

A - 8 PRE-DELIVERY SERVICE

Four Winns makes every effort to deliver your boat in 'turn key' condition to the dealer. The process of transporting and handling the boat necessitates certain inspections and adjustments prior to delivery to you. Also, various aspects of operation must be checked and adjusted immediately prior to final delivery and use.

The selling Four Winns dealer must perform this thorough review of the boat and its numerous systems during the commissioning or "dealer pre-delivery service" of the craft.

A Four Winns Pre-Delivery Service Record form is provided with this manual. This form lists the many items encompassed by the pre-delivery service previously described. The Four Winns Pre-Delivery Service Record is a four-part form. The dealer is to check off the items as they are completed, and complete the form as indicated providing specific performance related information appropriately.

Your Four Winns dealer will sign the Pre-Delivery Service Record upon completion of the work. You will be asked to sign this form upon accepting delivery of the boat. Both you and your dealer are to retain one copy of the completed

Four Winns Pre-Delivery Service Record. The other two copies are to be mailed to the Four Winns Customer Service Department.

A - 9 REPLACEMENT PARTS

Four Winns dealers are equipped with a Four Winns Parts Manual that details the components of each model and their appropriate part numbers. Many Four Winns dealers inventory common replacement components.

In addition, Four Winns maintains specific records on the components used in the manufacture of each unit and makes a concerted effort to maintain components specifically to fill replacement part needs.

The Four Winns dealer from whom you purchased your boat is in the best position to meet your needs. If he does not have the needed item, he has the capability, through direct facsimile contact with the Four Winns Customer Service Department, to obtain it quickly. Four Winns will only sell replacement parts to established Four Winns dealers. If you relocate and cannot find a Four Winns dealer close to you, contact the Four Winns Customer Service Department for information on the nearest dealer in your area.

A - 10 CUSTOMER SATISFACTION SURVEY

Four Winns, in association with Outboard Marine Corporation, participate in an on-going market study of the purchasers of our products. Our concern and desire for your complete satisfaction is genuine. Should you receive such a survey, we would appreciate your comments and any suggestions you may have. Each dealer, the product, and our customer support services are rated based upon the responses received.

A - 11 WINNGEAR™

Show your colors! Four Winns offers a complete line of sports clothing designed to complement your new boat. Your Four Winns dealer has a complete catalog and pricing.



ENGINES AND INSTRUMENTATION

B - 1 GENERAL

WARNING

DO NOT attempt to service any engine without being totally familiar with the safe and proper service procedures. Certain moving parts are exposed and can prove dangerous to one unfamiliar with the operation and function of the equipment.

Four Winns, Inc. does not manufacture engines. Because of the technical nature of the engines, all manufacturers of these items require that warranty and service problems be taken directly to an authorized dealer for resolution. The Four Winns dealer from whom you purchased your boat will handle all warranty and service matters with the engine manufacturer for you.

In compliance with the Federal Boat Safety Act of 1971, all engine manufacturers require their products to be registered. A registration card is furnished with each new engine. When selling a Four Winns boat, the dealer, along with the purchaser, should complete the information requested on these cards and return them to the respective engine manufacturers. Engine registration cards are provided with the engine and will usually be found with the boat literature.

Each manufacturer of the various marine power components provides an owners information manual with their product. This publication is included with this manual. It is important that you read the manual(s) carefully and become completely familiar with proper care and operation of the engine system. Be sure to read the section on winterization. Replacement costs associated with frozen engine components are quite substantial.

Also review the other sections in this manual, especially Sections F on Fuel Systems, and Section C on Control Systems.

B - 2 ENGINE EXHAUST

The carbon monoxide in exhaust fumes can be hazardous. It is important for you and your passengers to be aware of the potential safety hazard created by exhaust fumes. Familiarize yourself with the symptoms of individuals overcome by carbon monoxide, and most importantly, ways you can protect yourself and your guests.

WARNING

DO NOT inhale exhaust fumes! Exhaust contains carbon monoxide which is colorless and odorless. Carbon monoxide is a dangerous gas that is potentially lethal.

Persons overcome by carbon monoxide may exhibit the following symptoms:

- a. Watery and itchy eyes
- b. Flushed appearance
- c. Throbbing temples
- d. Inattentiveness
- e. Inability to think coherently
- f. Ringing in the ears
- g. Tightness across the chest
- h. Headache
- i. Drowsiness
- j. Incoherence
- k. Nausea
- l. Dizziness
- m. Fatigue
- n. Vomiting
- o. Collapse
- p. Convulsions

IF YOU THINK EXHAUST FUMES ARE ENTERING YOUR BOAT, DETERMINE THE CAUSE AND HAVE IT CORRECTED IMMEDIATELY!

The following suggestions can help prevent exhaust fumes from entering the boat:

1. DO NOT allow the boat to remain stationary with the engine running for an extended period of time.



2. Use extreme caution while operating the engine in confined areas such as enclosed slips or congested piers. Operation under such conditions could easily lead to exhaust gases (carbon monoxide) entering even though you may have all the hatches, windows, doors and portholes closed.
3. Persons sleeping can be easily overcome by carbon monoxide because they are unaware of its presence. Sleeping while the engine is running is not recommended. If persons are sleeping aboard while underway, those awake should monitor for carbon monoxide accumulation in the cabin; especially the sleeping areas.

⚠ WARNING

NEVER operate the propulsion engine while everyone on-board is sleeping. Fatal carbon monoxide poisoning can occur.

For additional information, refer to Section H-4 Carbon Monoxide.

B - 3 ENGINES

Consult the Engine Owners Manual provided with this manual for additional operation and maintenance information.

B - 4 PROPELLERS

Knowledge of the propeller is most easily gained through better understanding of the terminology used to refer to the aspects of propeller size and performance.

A. Diameter

Diameter is twice the distance from the center of the prop shaft to the extreme tip of a propeller blade. Increasing or decreasing propeller size will have a direct bearing on the RPM's an engine will develop. This is due to the greater amount of propeller blade surface in contact with the water. See Figure B1.

B. Pitch

Pitch is a measure of helix angle, or angle of attack, of the rotating blade. Pitch is easily understood if one imagines the propeller rotating through a semi-solid such as butter or jello. The distance the propeller will travel in one revolution is called "Pitch." Increasing or decreasing pitch will also have a direct bearing on engine RPM's because of the greater bite taken by the blade with each rotation. See Figure B1.

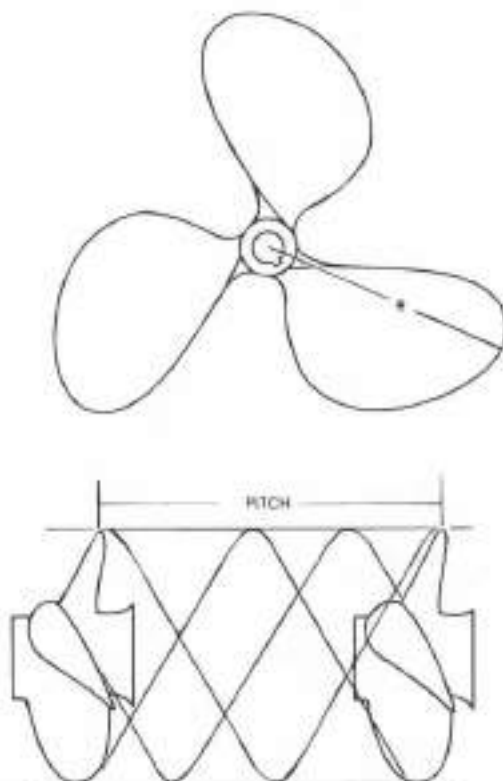

Figure B1: Propeller Pitch & Diameter

C. Prop Slip

When traveling through water a propeller is unable to get a complete bite because of the fluidity of water. "Prop Slip" is usually expressed as a percent of the computed theoretical speed. Fifteen to twenty-five percent prop slip is common for a sport-type boat operating at cruising speed.

Therefore the deduction can be made that a propeller, of a certain diameter, with a 10 inch



pitch, rotating at 3600 revolutions per minute, with a prop slip of 30%, would move the boat at a rate of 24 miles per hour.

Changing either diameter or pitch will have an effect on engine speed and prop slip, and in turn, directly effect the performance of a boat. The propeller(s) included with each Four Winns boat provide the best general performance based on data obtained from on-the-water testing of that model. Variations in load, operating conditions, environment, the individual engine and hull performance may necessitate the purchase and use of another propeller(s).

Under your normal load conditions the engine(s) should turn within the maximum RPM range when at full throttle. If the engine(s) exceeds the recommended RPM, an increase in pitch and/or diameter is required. If the engine RPM is too low, a decrease in pitch and/or diameter is required.

An engine that is not developing full power and the load carried in a boat will directly affect performance of the engine. Always be sure the engine is properly tuned and load conditions are those normally experienced, before changing propellers.

For additional information on factors affecting performance, please consult your Four Winns dealer.

B - 5 RUNNING ANGLE & POWER TRIM/TILT

Hull planing surfaces have the least amount of drag at a three to five degree angle with the water. This is the preferred running angle when boating. The running angle has a significant impact on top speed and handling. See Figure B2. Heavy load or certain water conditions may make it difficult to achieve the optimum running angle.

The running angle can be controlled through the use of power trim and trim tabs. See Section B-6 Trim Tabs, for information on the use of trim tabs.

A. Power Trim

Trim angle is how far in or out, the drive or outboard motor is positioned in relation to the bottom of the boat. The trim angle of the drive or outboard engine has a distinct effect on the running angle of the boat.

The power trim system permits control of the trim angle of the drive or outboard motor relative to the boat, at the touch of a button.

It allows the drive or outboard motor to be raised for shallow water operation. Power trim also allows the operator to adjust the motor while underway to provide the ideal running angle for a given load and water condition. Additional information can be found in the engine operator's manual.

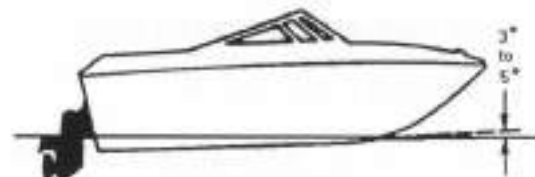

Boat Properly Trimmed

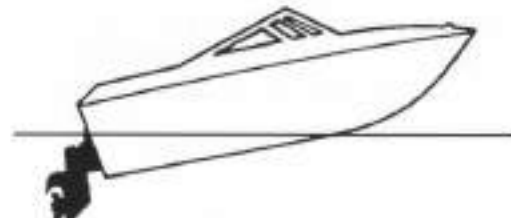

Bow Too High - Trim Bow "Down"

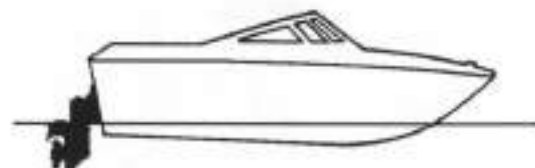

Bow Too Low - Trim Bow "Up"

Figure B2: Running Angle

B. Power Tilt

Power tilt allows the operator to raise and lower the drive or outboard motor for trailering, launching, and beaching. Additional information on



power tilt can be found in the engine operator's manual.

NOTICE

DO NOT operate the motor with the water intakes out of the water. Severe damage to the engine systems can result. Consult the engine operator's manual for specific information.

B - 6 TRIM TABS

Electric/hydraulic trim tabs are optional on some models and help provide maximum control of the hull in all water and load conditions. If used properly, trim tabs can

- a. Compensate for wind and load listing (level the boat side to side).
- b. Induce faster planing and help achieve optimum running angle (see Section B-5 Running Angle & Power Trim/Tilt).

The proper use of electric/hydraulic trim tabs require a basic understanding of trim tab operation and some practice in calm water.

The trim tab control uses two (2) momentary-type rocker switches. The trim tab switches control the attitude or position of the boat. See Figure B3.

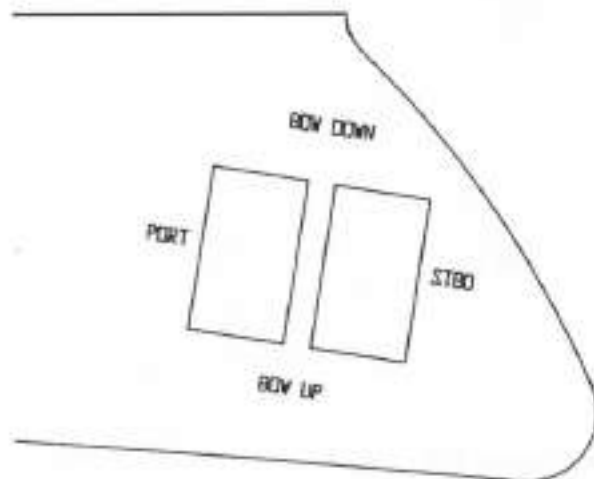

Figure B3: Trim Tab Switches

Before leaving the dock and utilizing the trim tabs, ensure the trim tabs are in the full up position.

Depress both lower halves of the trim tab switches and hold (for approximately 10 seconds) until the tabs are full up.

A. Control Listing

Wind, loading and many other factors can result in the boat tilting or leaning towards one side while running. This is called listing and can be negated using trim tabs.

Pressing the lower port trim tab switch will move the port trim tab upward. This will result in the starboard bow of the boat being allowed to rise.

Pressing the lower starboard trim tab switch will cause the starboard trim tab to move upward and will result in the port bow being allowed to rise.

Depressing the upper port trim tab switch will cause the port trim tab to move downward and will force the starboard bow downward.

Depressing the upper starboard trim tab switch will cause the starboard trim tab to move downward and will force the port bow downward.

Always establish your intended heading and attain desired cruising speed before trying to adjust running attitude (using the trim tabs).

WARNING

Always press the trim tab switches in short 1 second bursts. If depressed too long, you can overcompensate, and potentially lose control. DO NOT try to correct the situation by depressing the other upper trim tab switch. Instead, raise the tab slightly by depressing the appropriate lower half of the trim tab switch.

NOTICE

DO NOT depress both switches in opposite directions. This will cause a short in the trim tab motor and blow a fuse.



After stabilization of speed and direction, depress the upper half of the appropriate trim tab switch to achieve a level side to side running attitude. Be sure to press the correct trim tab switch to obtain the desired result.

After depressing a trim tab switch, always wait and allow time for the change in trim tab position to take effect. DO NOT continue to depress the trim tab switch while awaiting trim tab reaction. By the time the effect is noted, the trim tab will move too far and thus overcompensate.

B. Induce Planing & Control Trim Angle

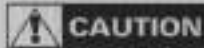

The use of trim tabs to attain quicker planing should not be used by inexperienced boaters. The combination of extreme inward drive position and extended trim tabs can dangerously affect the boats handling under certain sea conditions.

Trim tabs can also be used to facilitate faster planing and allow better control of the running angle.

Before accelerating and trying to gain plane, depress both upper trim tab switches. This will cause both trim tabs to move downward and force the bow down when running. This can also be used when running the boat with a heavy load aboard.

Moving the trim tabs downward will increase the lift and the boat will achieve plane faster, or stay on plane at a lower engine and boat speed.

After gaining plane and establishing cruising speed, depressing both lower trim tab switches will cause both trim tabs to move upward and will allow the bow to rise. This should be used to adjust the running attitude of the boat to decrease the drag at cruising speed or above, or when running in a following sea.

When running at an engine speed that results in the boat falling off plane or causes the boat to plane inefficiently, lowering both tabs slightly (bow down) will improve the running angle and improve operating efficiency.

Optimum efficiency is obtained when operating at a 3 to 5 degree running angle. Utilizing too much "Bow Down" trim tab can reduce operating efficiency and cause substantial steering and handling difficulties. Be extremely careful when running in a following sea. The effect of trim tabs is amplified under such conditions. Steering and handling difficulties can result from improper trim tab usage, especially in a following sea. If unsure of proper trim tab positioning, raise the trim tabs to the full-up position.

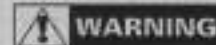

When running at high engine speeds, be sure the trim tabs are in the full up position. Trim tab action should be only enough to compensate for any listing. Trim tab adjustments at high speeds are extremely critical. Be prepared to slow down should handling difficulties arise.

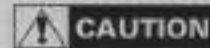

The combination of extreme inward drive position and extended trim tabs will cause a severe bow down running angle. In certain sea conditions, this will limit the operator's control over the boat.

When running in a displacement (very slow speed) mode, better efficiency will be obtained with the trim tabs in the full-up position.

C. Trim Tab Maintenance

Check the fluid level of the trim tab reservoir often. Always keep the fluid level between the designated marks on the trim tab pump-reservoir. Refer to the manufacturers information for specifications on the type of fluid to be used and other operation and maintenance information.

B - 7 ENGINE INSTRUMENTATION

The helm station is equipped with a complete set of engine instruments. These instruments allow the boat operator to constantly monitor the operational condition of the engine. Close observation of these instruments could save the engine from damage.

Four Winns is using a new style of instrumentation package which consists of a module similar to units used in the automobile industry. See Figure B4. All models except Freedom will have this module. The Freedom has standard gauges in the dash panel.



Figure B4: Dash Module

A. Tachometer

The tachometer indicates the speed of the engine in revolutions per minute (rpm). This speed is not the boat speed or necessarily the speed of the propeller. The tachometer may not register zero with the Ignition Key in the OFF position.

NOTICE

Never exceed the maximum recommended operating RPM of your engine. Maintaining maximum, or close to maximum RPM for extended periods can reduce the life of the engine.

Some engines are equipped with devices that limit engine rpm in accordance with the oil pressure, or engine temperature. Refer to the engine manual for additional information.

The tachometer must be set for different engines installed. The tachometer setting screw or knob is located on the backside of the gauge. See Figure B5. The tachometer should be set according to the information in Table 1. On outboard models with the new module, the tach is preset internally.

B. Speedometer

The speedometer is a water pressure sensitive unit. It has a pick-up (pitot tube) assembly mounted on the transom and a small plastic hose (speedo tube) that connects it to the speedometer gauge on the dash. See Figure B5. The pitot tube extends below the hull. Water strikes

the tube inlet and creates positive pressure. The faster the boat speed, the greater the pressure, and the higher the speed indication on the speedometer.

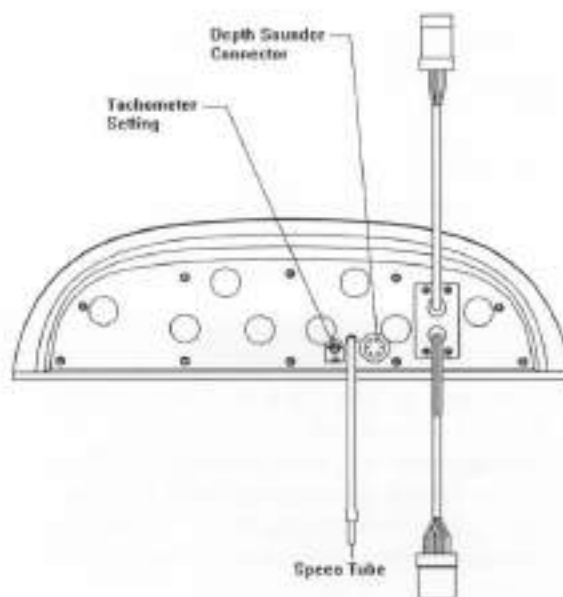

Figure B5: Rear View of Instrument Module

Engine Size	Tach Setting
4 Cylinder	2
6 Cylinder	3
8 Cylinder	4
Outboard (If Applicable)	6

Table 1: Tachometer Adjustments

If the pick-up becomes clogged, the speedometer will not register. Clean the opening with a piece of wire or disconnect the tubing and blow out the pick-up with compressed air.

When winterizing the boat, the speedometer tubing must be drained of water. Disconnect the speedometer hose at the pick-up assembly and at the gauge and blow through the tubing to remove the water.



NOTICE

Speedometers are not precision instruments. The indications are relative and should never be used for navigational purposes or similar critical situations.

NOTICE

DO NOT rely on the speedometer when trying to achieve a "NO WAKE" condition in a harbor or other enclosed waterway. ALWAYS reduce throttle! Speedometers are not effective at measuring low operational speeds. You are responsible for damage caused by the wake of your boat.

C. Temperature Gauge

The temperature gauge monitors the cooling system of the engine. A sudden increase in the temperature could be a signal of a blocked cooling passage or a water pump malfunction.

NOTICE

Operation of an overheated engine can result in engine seizure. If an unusually high temperature reading occurs, shut the engine off immediately.

D. Oil Pressure Gauge

The Oil Pressure Gauge indicates the pressure in the engine lubrication system. A drop in oil pressure is a possible indication of oil pump or leakage problems.

NOTICE

Operation of an engine with abnormally low oil pressure can lead to engine damage and possible seizure. Have the engine serviced immediately upon a reduced oil pressure indication.

E. Water Pressure Gauge (Outboards Only)

The water pressure gauge monitors the cooling system of the engine. A decrease in water pressure indicates a problem with the water intake and needs to be checked immediately. A drop in water pressure will result in an increase in engine temperature and could damage the engine.

NOTICE

Operation of an overheated engine can result in engine seizure. If the water pressure drops to zero, shut the engine off immediately.

F. Voltmeter

The voltmeter monitors battery condition and thus alternator performance. See Section E Electrical Systems for additional information on voltmeter operation.

G. Fuel Gauge

The Fuel Gauge displays the level of fuel that is present in the fuel tank. The fuel gauge will operate when the ignition switch supplying power to the fuel gauge is in the RUN position.

Due to the mechanical nature of the fuel sender, variations in readings during various speeds of operation may occur. This system is merely a relative indication of the available fuel supply and not a calibrated instrument. Relative adjustments can be made by your Four Winns dealer by bending the fuel sender float arm. Refer to Section F-1f Fuel Sender for additional information.

NOTICE

Use only clean fuel of the type and grade recommended by the engine manufacturer. The use of incorrect or contaminated fuel can cause engine malfunction and serious damage. Refer to Section F Fuel Systems for additional information.

H. Power Trim Gauge

Boats equipped with Stern Drives also have a "Power Trim Gauge." This gauge provides a visual indication of the inward-outward (trim angle) position of the outdrive.

I. Depth Sounder

The depth sounder is optional equipment on all models. Additional information on depth sounders can be found in Section J-6b in this manual.

J. Ignition Switch

The ignition switch has three positions: OFF, RUN, and START. The START position is spring loaded and the key should be held in this position until the engine starts. The key will return to the RUN position once released. Always turn the key to the OFF position when the engine is not running. This will prevent discharging of the battery(s). Additional information on ignition switch operation is covered in Section Q Operation, of this manual.

K. Emergency Ignition Shut-Off

The emergency ignition shut-off switch is provided on all sport boat models. Its use is highly recommended when underway. The switch has a lanyard (cord) attached to a clip which must be in position for the engine to run. The boat operator can attach the cord to a belt loop, life jacket, etc. See Figure B6.

NOTICE

DO NOT attach the lanyard to clothing that will tear away before the lanyard is pulled from the switch to stop the engine.

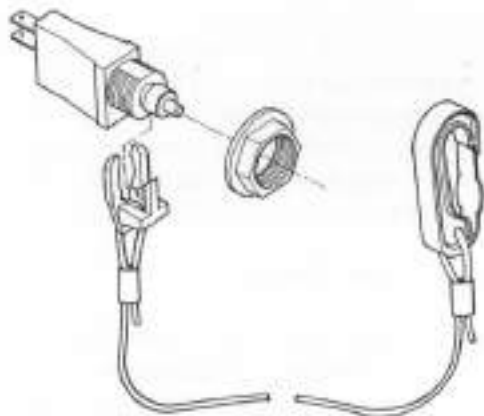

Figure B6: Emergency Stop Switch

If the clip is not in position, the starter and other systems will still operate **but the engine will not start**. Should the boat operator move beyond the range of the lanyard, the lanyard will pull the clip from the switch, shut off the engine and prevent the boat from becoming a runaway. If the lanyard is too long, it can be shortened by

knocking or looping it. DO NOT cut and retie the lanyard.

The emergency stop switch can only be effective when in good working condition. Observe the following:

1. Lanyard must always be free of entanglements that could hinder its operation.
2. Once a month, check the switch for proper operation. With engine running, pull lanyard. If the engine does not stop, see your Four Winns dealer.
3. Once a month, inspect both the clip and lanyard for cuts, breaks or wear. Replace worn or damaged parts.

In an emergency situation, any occupant of the boat can restart the engine. Just press in and hold the emergency stop switch button, then follow normal starting procedures. When the button is released, the engine will stop.

CAUTION

Avoid knocking or pulling the clip or lanyard from the switch during regular boating operation. Occupants may be thrown forward or possible engine damage may occur by the sudden loss of engine power.

L. Engine Hour Meter

Engine hour meters are optional on most models and provide a numeric record of elapsed engine operating time. This information is important in determining scheduled maintenance intervals, ships log data, cruise information, etc. If so equipped, the hour meter will be located in the engine compartment.

The hour meter is connected to the ignition switch. Be sure the ignition switch is in the OFF position when the engine is not operating or the hour meter will record additional time.

M. Alarm Systems

Engine alarm systems are installed on some models. The alarm is an audible alarm that is



mounted in the helm area; it is actuated by various engine sensors. Additional information can be found in the engine owners manual.

N. Instrument Maintenance

Electrical protection for instruments and ignition circuitry is provided by fuses on or below the instrument panel.

Periodically, spray the ignition switch with a contact cleaner. The ignition switch and all instruments, controls, etc. should be protected from the weather when not in use. Four Winns offers appropriate weather covers for each model. Excessive exposure can lead to gauge and Ignition Switch difficulties.

NOTICE

DO NOT use a product such as WD-40 as a contact cleaner. Be sure to read the label before using any product.

Electronic gauges are affected by static electricity that builds-up on the glass face. Periodic washing of the gauge face with warm water and mild liquid detergent will help eliminate the static electricity problem and improve gauge accuracy.



CONTROL SYSTEMS

C - 1 GENERAL

Control systems permit operation of the engine's throttle and shift mechanisms. They consist of three major components: the control, and the throttle and shift cables.

Your Four Winns boat is equipped with a single lever concealed side mount or binnacle mount control. This allows you to select forward or reverse gear, regulate engine speed, and ensure shifting is done at low engine speed.

A start-in-neutral-only feature which prevents starting in gear is included. Refer to C-3 Neutral Safety Switch in this section.

Also, the side mount control has a neutral lock button to prevent accidental shifting. It must be squeezed to permit shifting from neutral to forward or reverse.

Neutral is in the center or straight up position. Rotating the control forward shifts the engine into forward. Rotating the control aft shifts the engine into reverse. Moving the lever further forward or aft increases engine speed.

Specific information on controls and their operation can be found in the section on "Starting and Operation" in the engine manufacturer's manual.

C - 2 CONTROL OPERATION

A. Standard Engines

The shift mechanism on the controls can be disengaged to allow for easier starting and engine warm-up. See Figure C1. To disengage:

1. Place control handle in neutral position (B).
2. Press both neutral lock button (A) and shift disengage button (C).
3. Move control handle forward to increase throttle.

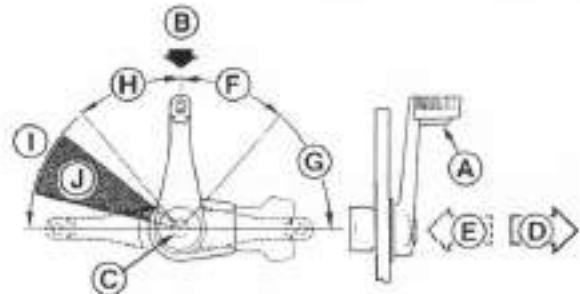

Figure C1: Control Operation

The neutral lock and shift mechanism will automatically engage when the control handle is returned to the neutral position.

4. Shift Mechanism Engaged (D).
5. Shift Mechanism Disengaged (E).
6. Reverse Shift Range (F).
7. Reverse Throttle Range (G).
8. Forward Shift Range (H).
9. Forward Throttle Range (I).

Refer to the engine manual for additional information on control operation.

B. Multi-port Fuel Injected Engines (EFI)

On Multi-port Fuel Injected engines, starting the engine is much easier and faster. It is not necessary to use the throttle while in neutral to cold-start the engine. Simply turn the key and allow the engine to warm up.

For additional information, refer to the section on "Starting and Operation" in the engine manufacturer's manual.

C - 3 NEUTRAL SAFETY SWITCH

Control systems usually incorporate neutral safety switches within their design. This device



prevents the engine from being started while the shift lever is in any position other than the neutral position. If the engine will not start, slight movement of the shift lever may be necessary to locate the neutral position and disengage the safety cut-out switch. Control or cable adjustments are required to correct this condition should it persist. See your Four Winns dealer for necessary control and cable adjustments.

C - 4 CONTROL SYSTEM MAINTENANCE

Periodic inspections of the control, cables, and all connections should be made. Signs of looseness, rust, corrosion, wear, cable jacket cracks or other deterioration require immediate system servicing. Replace all damaged components.

Generally, periodic lubrication of all moving parts and connections with a light, waterproof grease is in order. Cables can be lubricated by positioning them to their fullest extension and applying light grease to the inner cable near the jacket. Working the cables back and forth will distribute the grease in the inner cable. Re-apply the grease if necessary.

Lubrication should be performed as often as necessary to keep the system operating smoothly. Cable manufacturers such as Teleflex, DMC, and Morse often offer special tools to make cable lubrication easier.

Cable and control adjustments may become necessary. Adjustment screws in the control, on the cables and in the linkage are provided.



WARNING

DO NOT attempt control adjustments unless you are familiar with control systems service procedures. Control misadjustment can cause loss of control.

Other lubrication, adjustment and maintenance instructions are included in the information provided by the control manufacturers.



STEERING SYSTEMS

D - 1 GENERAL

Four Winns boats are equipped with rotary or hydraulic-type steering systems. Tilt and power steering are features which are available on most models.

A. Rotary Steering

In the rotary system, a rotary drum assembly is mounted under the dash behind the steering wheel with a one piece cable running through the boat into the engine compartment. At the transom, the cable turns and is connected to the engine. Additional information on steering operation can be found in Section Q-9.

B. Tilt Steering

If equipped with tilt steering, depress the release lever with your thumb to tilt the steering wheel. See Figure D1. Be sure to hold the top of the wheel to assist in positioning. Refer to the steering manufacturer's literature for additional information.

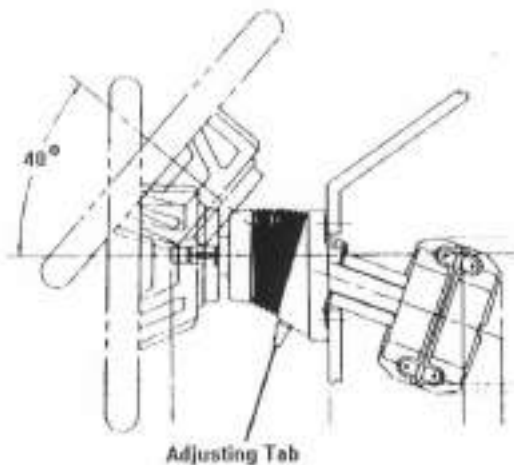
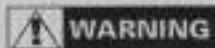

Figure D1: Tilt Steering Option



WARNING

The tilt mechanism should not be adjusted when the boat is moving. Sudden boat movement may cause loss of balance resulting in loss of control and/or injury.



WARNING

The tilt mechanism is spring loaded. Due to the variation in steering wheel offerings, the wheel may spring up rapidly when depressing the release lever. **ALWAYS KEEP ONE HAND ON THE WHEEL DURING TILT ADJUSTMENT OR INJURY MAY OCCUR.**

C. Power Steering

Power steering is also available. It is comprised of an engine mounted pump, hoses and steering cylinder. Power steering works in conjunction with the helm and steering cable to move the transom mount tiller arm and vertical drive more smoothly.

This is a "power assist" system and can greatly reduce steering effort required. It is not, however, a full power steering system as is used in automobiles. Some steering tension remains in the system.

On models with power steering, restricting movement of the steering cable will limit or stop the steering system's hydraulic assist.

NOTICE

DO NOT interfere with or restrict steering cable movement through the last 90° of bend at the engine. **DO NOT** use cable retainers, clamps or tie straps. Using one or all of these could restrict the cable movement near the engine. **DO NOT** tie wiring harnesses or other control cables to the steering cable. Make sure the deck coaming pads and bulkheads allow for steering cable movement in all positions of trim.

If the power steering becomes inoperative, steering will be harder and more effort will be needed to steer the boat. Check for a broken or loose belt on the power steering pump. Also, low fluid levels in the power steering pump reservoir will cause hard steering. If these items are not the source of the problem, check for equipment or

other items lying on or up against the steering cable at the back of the boat. The cable must be free and clear to slide back and forth. Any item blocking free movement of the cable will result in harder steering and possible damage to the steering cable.

If the power steering system cannot be corrected on board, proceed at a reduced speed. The boat will be steerable, but with increased effort. Return the boat to your Four Winns or OMC dealer as soon as possible to correct the power steering system.

CAUTION

If equipped with power steering, check the fluid level in the reservoir periodically. Low power steering fluid levels may increase steering difficulty.

CAUTION

After the first two hours of running time, check the entire steering system for loose bolts, nuts and fasteners which could adversely affect steering control.

NOTICE

When storing equipment in the engine compartment, be sure to avoid contact with the steering cable. Cables may become kinked or damaged and may increase steering effort.

Most Four Winns boats equipped with stern drives are equipped with power steering. This is a "power assist" system and can greatly reduce steering effort required.

NOTICE

DO NOT force the steering unit to either extreme. This can place undue strain on the unit and can lead to hydraulic line or seal failure.

It is important that the power steering fluid be maintained to the proper level. If equipped with a power steering unit, please consult the engine manual for additional information.

For additional information, refer to the steering manufacturer's literature included with this manu-

al. Also, refer to the section on Steering in your engine manual.

D. Hydraulic Steering

The hydraulic steering system is comprised of the helm pump and reservoir, hydraulic hoses, and the hydraulic cylinder. The helm assembly acts as a pump to move the oil through the system. In many aspects this type of steering is similar to the mechanical system. Instead of activating a cable, turning of the helm causes fluid in the hydraulic hoses to flow and activate the hydraulic cylinder causing the rudders or outboards to turn. See Figure D2.

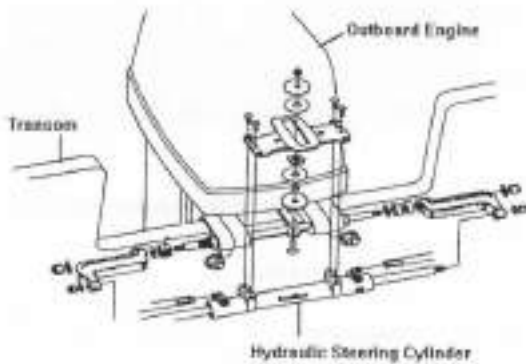

Figure D2: Hydraulic Steering

Upon commissioning the boat, it is necessary to purge the system of air. This is performed by your Four Winns dealer during pre-delivery service. Should steering difficulty increase with time, it is possible additional bleeding of the system is required. See your Four Winns dealer for assistance. This and other adjustments on power steering units are critical and should be performed only by a qualified service technician.

NOTICE

If equipped with the hydraulic system, a slight clicking sound may be heard as the wheel is turned. This sound is the opening and closing of valves in the helm unit; this is normal.

D - 2 PROPELLER TORQUE

The propeller rotation of a single engine installation will exert a directional force on the steering



system. This can cause the steering to be harder in one direction than the other, and is called propeller torque. If this occurs, adjust the drive or outboard's trim tab (when applicable). Refer to the engine manual for information on adjusting the trim tab.

Propeller torque can also cause the boat to wander (not follow a straight line) when operated at low speeds. This condition is normal and can be corrected only by increasing engine rpm. Wind, water currents and play in steering components can cause equivalent effects.

CAUTION

Steering effort can vary significantly with engine acceleration, steering angle, trim angle, and sea condition. Be prepared for additional steering loads at all times.

D - 3 STEERING SYSTEM MAINTENANCE

A. General Maintenance

A periodic inspection of all steering cables, linkage and helm assemblies should be made. Signs of corrosion, cracking, loosening of fastenings, excessive wear, or deterioration should be immediately corrected. Failure to do so could lead to steering system failure and corresponding loss of control.

NOTICE

Check all bolts, nuts and fasteners for tightness.

B. Rotary System Maintenance

The helm and cable assembly should be so adjusted that the steering wheel is centered with the drive or outboard engine in the straight ahead position. There should be an equal number of turns to port and starboard from the straight ahead position. If adjustment becomes necessary, see your Four Winns dealer.

Check all metal parts at the cable output end for corrosion. Remove any old grease from the cable ram and motor swivel connections using a mild solvent such as kerosene. Spray the cleaned areas with a moisture-displacing lubri-

cant and apply a light coat of good quality marine grease. Do this with the ram fully extended. See Figure D3.

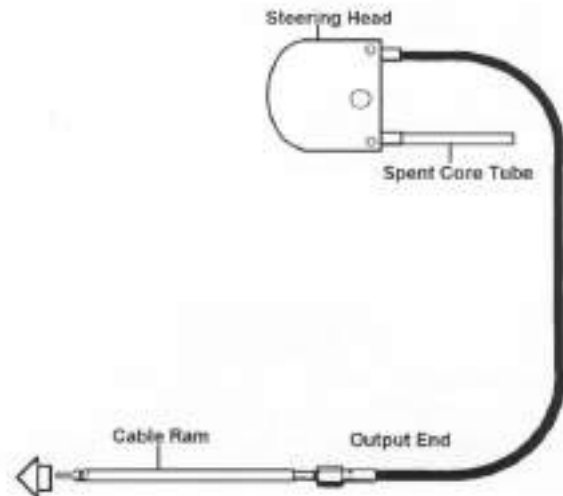

Figure D3: Steering Cable

C. Hydraulic System Maintenance

Hydraulic steering systems must periodically have all air purged from the system. Review the information provided by the hydraulic steering manufacturer for proper specifications and details on system service and maintenance.

D. Winter Storage

If the boat is placed in winter storage or used infrequently, clean the cable ram as instructed above. Cycle the steering several times when applying lubricant. If at any time the steering system becomes stiff, has an excessive amount of freeplay or shows any change in its operating characteristics, contact your Four Winns dealer to have the system inspected.



ELECTRICAL SYSTEMS

E - 1 GENERAL

All electrical equipment on Four Winns boats operate on 12 volt DC electrical power. Dual battery systems are optional on the 245 Sun-downer models only.

WARNING

To prevent equipment or electrical wiring damage, DO NOT tamper with any electrical connection, panel or harness, or attempt installation of any electrical equipment unless thoroughly familiar with the systems and are experienced in making such installations.

For detailed information on the electrical system, electrical schematics have been provided with this manual.

E - 2 BATTERY SYSTEM

A. Single Battery System

A single battery is provided as standard equipment (12 volt DC) per Section E-1 above. The dash components are protected by a fuse panel located below the helm. On Outboard models, a separate in-line fuse is provided at the battery. Refer to Figure E1 and to the wiring schematics in the back of this manual.

NOTICE

Some later models will have a decal located near the battery showing battery connections.

When installing the battery, proceed as follows:

1. Connect the red (positive) cable running from the engine starter solenoid to the positive (+) battery terminal. On models with EFI engines, a separate red, power wire must also be attached to the positive battery terminal.

2. Connect the black (negative) battery cable running from the engine block to the negative (-) battery terminal.

CAUTION

When disconnecting the cables from the battery, make sure all switches are off and disconnect the black negative cable first to prevent spark.

NOTICE

DO NOT disconnect the battery while the engine is running. Alternator damage could result.

Monitor the battery's condition regularly with the Voltmeter in the dash panel. For additional information, refer to Section E-4 Electrical System Maintenance.

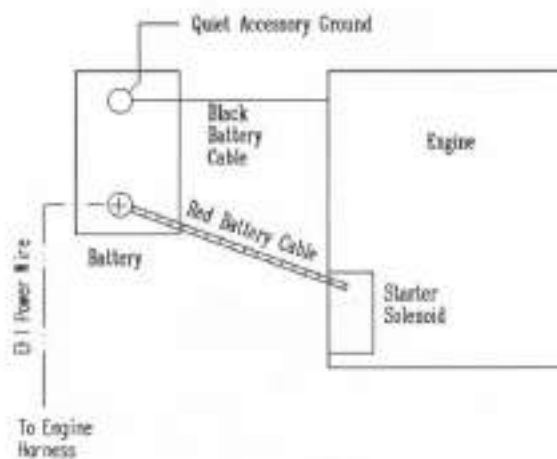

Figure E1: Single Engine-Single Battery Installation

B. Dual Battery System

A battery selector switch is provided on single engine, dual battery installations. This allows DC power to be used from either one or both batteries. Refer to Figure E2.

When installing dual batteries, proceed as follows:



1. Connect each of the red battery cables leading from the battery selector switch to the positive (+) terminal on each of the two batteries.

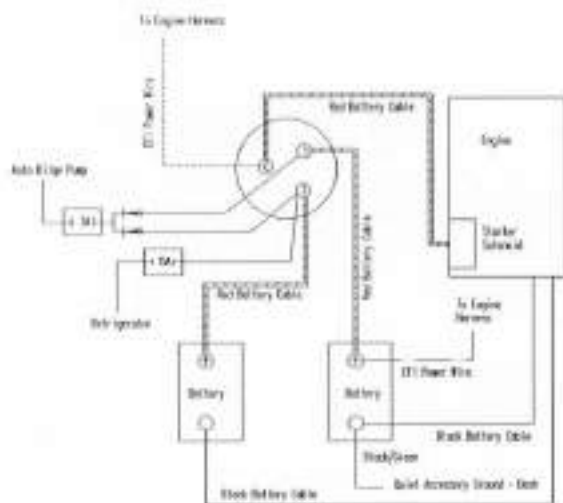
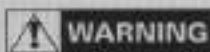

Figure E2: Single Engine-Dual Battery Installation

NOTICE

Be sure both cables are installed on the positive (+) battery terminals.

2. Connect the black battery cable to the port negative (-) battery terminal (see Section E-2, 2 above). Connect the other black battery cable to the starboard negative (-) battery terminal.



WARNING

When disconnecting the cables from the battery, make sure all switches are off and disconnect the black negative cable(s) first to prevent spark.

C. Battery Switch Operation

Power to the engine and all 12 volt electrical equipment (except the automatic bilge pump and refrigerator) is controlled by the battery selector switch. See Figure E2.

Battery selector switch positions:

"OFF" - With the battery selector switch in the "OFF" position, all 12 volt power to the boat is

shut off completely except to the automatic bilge pump and refrigerator (if installed). A separate circuit breaker is provided on the battery switch panel for the automatic bilge pump. Always turn the battery selector switch to the "OFF" position when the boat is removed from the water.

NOTICE

DO NOT turn the battery selector switch to the "OFF" position while the engine is running. Alternator and wiring damage could result.

"1" - Turning the switch to position "1" will use battery #1 to power the engine and 12 volt equipment. Battery #2 will be isolated and remain in reserve. Only battery #1 will be charged by the alternator.

"2" - Turning the switch to position "2" will use battery #2. Battery #1 is isolated and remains in reserve. Only battery #2 will be charged by the alternator.

"ALL" - With the battery selector switch in the "ALL" position, the batteries are connected in parallel. Both batteries will be used by the engine and all 12 volt equipment. Both batteries will be charged by the alternator. However, the batteries will charge at a slower rate compared to setting the switch in the other positions.

The use of one battery at a time is recommended. Position the battery selector switch to either the #1 or #2 position.

When a refrigerator is installed, it is wired to the starboard battery and is not affected by switch position. When not in use, the refrigerator should be turned off. Please refer to the refrigerator owners manual and to Section I-5 in this manual for more information.

NOTICE

DO NOT use the "ALL" position when the refrigerator is running. This will run both batteries down.

Under normal conditions, avoid using the "ALL" position. Use the "ALL" position only when a single battery is not capable of starting the engine.



Four Winns recommends alternating between batteries during boating. Depending upon boating use, this may increase battery longevity. Use battery #1 for the first day of a cruise and switch to battery #2 on the second day.

NOTICE

If a refrigerator is installed, it is very possible to run down the #2 battery. Alternating between batteries will not be as beneficial and the battery switch should be set on "1" or "ALL"

Position the battery selector switch to the battery that has sufficient power to start the engine (normally position "1"). After the engine is running, turn the battery selector switch to the battery that has the lowest charge. This will allow the alternator to charge the low battery. Utilizing the battery selector switch in this manner (instead of using the "ALL" position) will supply a greater charge to the battery.

FOR EXAMPLE: If battery #1 is fully charged and battery #2 is in need of a charge, use battery #1 to start the engine. After the engine is running and warmed-up, turn the battery selector switch to the #2 position. This will permit the alternator to charge the low, #2 battery.

E - 3 12 VOLT ELECTRICAL EQUIPMENT

A. Helm Equipment

The ignition, DC outlet, and panel switches are protected by a separate fuse panel located below the dash. Descriptions of individual switches are below.



CAUTION

To avoid equipment damage or electrical fires, use only replacement fuses that are of equal rating to the original fuse. Refer to the electrical schematic included with this manual for proper sizes.

Horn - To sound the horn, push the HORN button.

Aft Bilge Pump - The PUMP switch at the dash is used to manually activate the bilge pump in the

engine compartment. The bilge pump is used to remove water from the bilge (bottom of the hull) area of the boat by pumping that water overboard.

On most models, the aft bilge pump is equipped with an automatic bilge switch and will operate whenever bilge water rises above the pump stop level. This will cause the internal float to move upward and activate the pump.

This automatic bilge pump will be active when the battery selector switch is in the "OFF" position. The automatic bilge pump circuitry is connected to a circuit breaker on the battery switch panel. Refer to Section E-2c for additional information on battery switch operation.

When leaving your boat unattended for an extended period, check the charge on the battery(s) periodically. Also check the water level in the bilge and make sure the float switch is functional.

If the automatic bilge pump must be disabled, disconnect the wiring plug near the bilge pump.

Navigation & Anchor Lights - Moving the NAV/ANC LTS switch towards the NAV position activates the bow lights and the all-around light or both portions of the mast light. Move the switch to the ANC position to activate the all-around light or both the fore and aft portion of the mast light. The center switch position is OFF.

Wipers - The WIPERS switch activates the windshield wiper. This is an option for the starboard side only.

Trim Tabs - Trim tabs are optional on the 240 Horizon and 245 Sundowners only. If the boat is equipped with electric hydraulic trim tabs, the trim tabs are controlled by the TRIM TAB switches. Refer to Section B-6 Trim Tabs for more information.

Fishwell - This is optional on many models. A switch is provided at the dash to operate the aerator pump. Refer to Section G for additional information on the livewell.

Accessories - Additional 12 volt equipment may be added to the boat using the accessory switch. Certain accessories may be wired directly to the fuse block below the dash. For more information,



refer to Section E-3b Installation of Additional 12 Volt Equipment.

Cockpit Lights - The CKPT LTS switch is used to activate the cockpit (courtesy) lights.

Cockpit Sink - The cockpit sink water pump is activated by a remote switch located within the cockpit sink compartment.

Transom Washdown - A separate water pump is installed in the engine compartment for the transom washdown system. A separate switch panel is provided to supply power to the pump.

B. Installation of Additional 12 Volt Equipment

On the fuse panel, non-factory installed 12 volt accessory equipment can be connected to the "ACC" terminal. Accessory equipment can also be wired directly to the "ACC" switch on the dash.

CAUTION

Be sure to provide proper fuse protection for all 12 volt equipment that is installed. Accessory current should be limited to 20 amp if the connection is made to the fuse block. If the "ACC" switch is used, the current should be limited to 15 amp. Gauge and 12 volt equipment may operate improperly and cause possible internal damage at higher levels.

C. Interior Equipment

Stereo - On all models, the stereo is mounted at the dash. It is connected at the fuse block and has a separate in-line fuse provided in the stereo wiring for protection. For additional information, refer to the manufacturer's operation manual included with this manual.

Cabin Lights - Cabin lights are equipped with remote switches and are standard on all cabin models.

The REFRIGERATOR circuit breaker on the battery switch panel protects the refrigerator. This is available as an option only on the 245 Sundowner model. The refrigerator will automati-

cally operate on the 12 volt system. This can deplete the battery quickly, and excessive drain on the battery may cause irreparable battery damage. Dual battery installation is required for this option. Refer to Section E-2c Battery Switch Operation and Section I-5 Refrigerator for additional information.

D. Fish & Ski Option

The Freedom and 190 Horizon outboard models are available with Fish & Ski options. This includes a trolling motor, two batteries, livewell, and separate electrical panel at the helm. A wiring schematic of this option is included in the back of this owners manual.

The switch located on the forward panel operates the voltmeter to determine charge on the trolling motor batteries.

To charge the trolling motor batteries, the batteries must be removed from the boat and charged on a portable battery charger.

CAUTION

When disconnecting the cables from the battery, make sure all switches are off and disconnect the black negative cable first to prevent spark.

E - 4 ELECTRICAL SYSTEM MAINTENANCE

A. Battery Maintenance

Be sure to keep the batteries charged. Also, keep the batteries clean, especially the terminals and connection lugs. The battery cables must be fastened securely while in use.

Check the battery fluid level often, especially when a charger/converter is being used. Recharge a battery indicating a low voltage. Determine the reason for the discharge. Alternating battery usage with dual batteries is important. Refer to the Electrical System section in the engine manufacturer's manual for additional information on care and maintenance of batteries.



B. Electrical Wiring Maintenance

Periodically, inspect all wiring for nicks, chaffing, embrittlement, improper support, etc. Spraying the electrical connections with an electrical connection cleaner will reduce corrosion and improve electrical continuity.

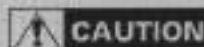

DO NOT allow corrosion to build up on connections. This can cause equipment to operate improperly.

E - 5 STRAY CURRENT CORROSION

A. General

Electrically induced underwater corrosion occasionally affect boats and their related components. This is referred to as "Stray Current Corrosion" and appears as surface pitting or deterioration. Stray current corrosion is the decomposition of chemical compounds by electric current.

Stray current corrosion can be caused by the polarity of the dockside wiring system of the boat being reversed from the power source (reversed polarity) or surrounding boats, an improperly wired battery installation, other boats that are in close proximity that have electrical power leakages, or any other source close to the boat that has electrical power leakage into the water. Stern drive units are especially vulnerable to stray current corrosion.

Periodically inspect the drive components and thru-hull fittings to determine if stray current corrosion damage exists. If corrosion damage is found, determine and correct the cause of stray current to prevent further damage. Consult an experienced marine electrician or contact your Four Winns dealer for assistance.

The use of some shore power battery chargers, while the boat is in the water and the battery is connected to the system, can cause stray current corrosion. Have an experienced marine electrician review any battery charger installation to ensure a stray current corrosion problem will not

develop. An improper battery connection is a common cause of stray current corrosion.

NOTICE

Use only "Coast Guard" approved battery chargers. Consult your Four Winns dealer for his recommendations.

Corrosion is usually more prevalent in polluted or salt water than in clean water. It is also more likely to occur when dockage is in an area with steel piers, large metal boats, or where shore power is in use.

B. Galvanic Corrosion

Galvanic corrosion results from a potential electrical difference existing between dissimilar metals immersed in a conductive solution (e.g., salt water). If these metals touch or are otherwise electrically connected, this potential difference produces an electron flow between them. The attack on the more active metal is usually increased and the attack on the less active metal is decreased, as compared to when these metals are not touching.

C. Corrosion Prevention

Anti-corrosion anodes are attached to the bottom of the gimbal housing to prevent corrosion to your stern drive and underwater parts. These anodes will be slowly eroded away by galvanic action and require periodic inspection. Please refer to the section on "Anti-Corrosion Anodes" in your engine manufacturer's manual for additional information.

FUEL SYSTEMS

F - 1 GASOLINE FUEL SYSTEMS

Gasoline fuel systems used in Four Winns boats are designed to meet or exceed the requirements of the U.S. Coast Guard, the National Marine Manufacturers Association, and the American Boat and Yacht Council in effect at the time of manufacture.

Tanks on Four Winns boats are located forward of the aft bilge compartment below the floor. Below is a list of fuel tank capacities by model.

Fuel Tank Capacities

MODELS	CAPACITY
Freedom	18 gal.
190 Horizon	28 gal.
200 Horizon	35 gal.
220 Horizon	50 gal.
240 Horizon	65 gal.
214 Candia	35 gal.
195 Sundowner	28 gal.
205 Sundowner	35 gal.
225 Sundowner	50 gal.
245 Sundowner	65 gal.

NOTICE

Use only clean fuel of the type and grade recommended by the engine manufacturer. Engine damage resulting from the use of a lower octane gasoline is considered misuse of the engine and will void the engine warranty. Refer to the section on Gasoline Requirements in the engine manual for information on octane specifications.

A. System Testing

All gasoline fuel systems have been factory inspected and pressure tested in accordance with

regulations in effect at the time of manufacture. Additionally, each fuel tank must pass rigid tests and inspections performed by the fuel tank manufacturer.

Prior to taking delivery, it is important that a full inspection be made of the entire fuel system by the selling dealer. An entry on the Four Winns Pre-Delivery Service Record will attest to the dealer's performance of this service.

B. Fuel Fills

Fuel fill deck plates are located either on the aft deck or side decks, and are marked "GAS". To open, push the tab in and lift up on the cap. Be sure to utilize the proper type and grade fuel. See Section F-3 for additional information.

The fuel fill fitting allows for venting below the fill cap. While the tank is being filled, the air displaced by the fuel escapes through the fuel fill/vent. This reduces the amount of fuel spillage. ALWAYS open the lid slowly to allow air to escape. See Figure F1.

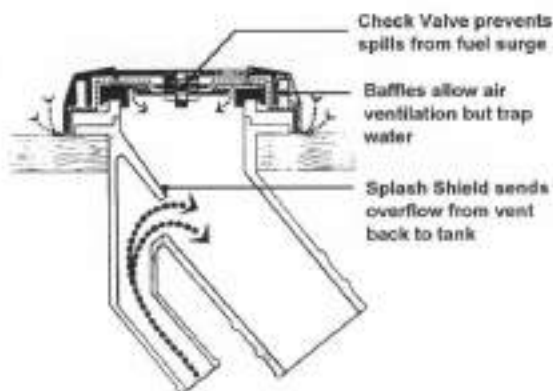

Figure F1: Gas Fill (Attwood #3663-1)

The gasket seal on the fuel fill cap assists in sealing when closed. A missing or damaged gasket can allow water on the surrounding surfaces to run into the tank. Periodically inspect the gasket and the fuel deck plate for damage.



WARNING

DO NOT confuse GAS deck fill plate with WATER or WASTE deck plates. Deck fill plates are labeled according to the intended use.

WARNING

Spilled fuel is a fire hazard. DO NOT overfill or overflow the tank, or allow fuel spills into the hull or bilge. If spillage occurs, clean up immediately and dispose of soiled rags/towels in a proper container.

NOTICE

When fueling at a marina, DO NOT overfill. Fuel may spill into the water.

After fueling, replace the fill cap, and wash the areas around the fuel fill plate. Residual fuel left on the deck and hull sides can be dangerous, and will yellow the fiberglass. It will also damage the tape stripes and logos.

C. Anti-Syphon Valves

The fuel withdrawal line is equipped with an anti-syphon valve where the line attaches to the fuel tank. This valve prevents gasoline from syphoning out of the fuel tank should a line rupture. See Figure F2 for anti-syphon location.

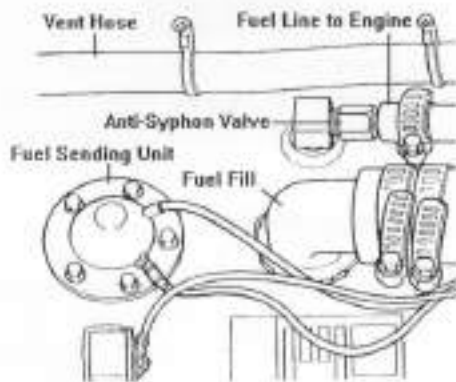

Figure F2: Fuel Tank Fittings

CAUTION

The fuel withdrawals are positioned in the fuel tanks to achieve optimum fuel usage, and fuel line routing. At certain speeds and hull trim angles, the fuel supply at the withdrawal tank location can increase or decrease accordingly. Be extremely careful when attempting to operate the boat on a minimum amount of fuel. Though some fuel may be in the tank, the relative trim angle of the boat may cause the fuel to flow away from the withdrawal.

NOTICE

Access plates or lids are provided in the floor for easier access to the fuel pick-up, anti-syphon valve and sender.

D. Fuel Gauge

The fuel gauge indicates the amount of fuel in the tank. See Section B-7g Fuel Gauge for additional information on fuel gauge use.

E. Fuel Senders

The fuel sender consists of a mechanical arm with float which measures the fuel in the tank. The sender arm adjusts with the amount of fuel in the tank and sends a signal to the fuel gauge. See Figure F3.

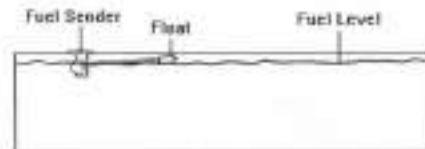

Figure F3: Fuel Sender Operation

Due to the mechanical nature of the fuel sender, variations in readings during various speeds of operation may occur. This system is merely a relative indication of the available fuel supply and not a calibrated instrument. Relative adjustments can be made by your Four Winns dealer by bending the fuel sender float arm.

The gauge readings will also vary with the trim angle of the boat. When sitting at a dock and the boat is nearly level, the fuel gauge will register accurately. Refer to Figure F3. When boating, the trim angle of the boat changes and affects the gauge readings. Under these conditions, the fuel sender will register "full" for the first few hours of running time until the fuel level drops below the 3/4 or 1/2 mark. This is caused by the angle of the fuel in the tank as shown in Figure F4.

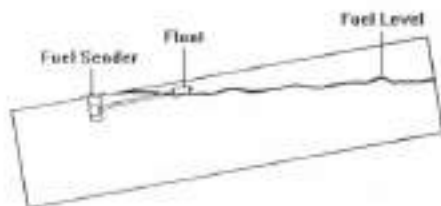

Figure F4: Effects of Trim Angle

It is very important to keep track of hours and fuel consumption to obtain an average gallon per hour consumption figure. This will prevent any problems with running out of fuel in the middle of the lake.

Dealers are equipped with some general figures on consumption which can be used as a guide until specific information on your boat is determined. Because of boating conditions, speed, weight and other factors common to your situation, fuel consumption will vary between your boat and consumption figures developed by Four Winns.

When the fuel gauge begins to register below the "full" mark, the gauge readings will drop much faster until it reads "empty". When this occurs, the trim angle has affected the sender reading. When the gauge registers "empty", the sender has bottomed out and there may be 3 to 4 gallons of fuel in the tank. See Figure F5.

F. Fuel Filters

Fuel filters are installed on each engine. Filters should be cleaned or changed frequently to assure an adequate supply of fuel to the engine. Refer to the engine manual for additional information.

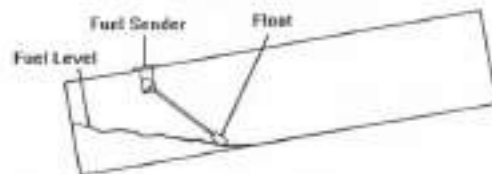

Figure F5: Trim Angle Effect with Low Fuel

NOTICE

OMC canister-type filters should be changed annually.

G. Use and Maintenance

WARNING

DO NOT let the odor of gasoline go unchecked. If the odor of gasoline is noted, DO NOT START ENGINE. If engine is running, SHUT OFF ENGINE, ELECTRICAL AND HEAT GENERATING EQUIPMENT. Investigate and correct the situation immediately! Have all passengers put on personal flotation devices and keep fire extinguishers at hand until the situation is resolved.

Periodically inspect all connections for leakage and all hoses for damage or deterioration. Replace as necessary.

WARNING

To help guard against damage, avoid the storage or handling of gear near the fuel lines, fittings and tanks.

F - 2 FUEL STANDARDS

Be cautious when using gasoline that contains alcohol. Refer to the section on gasoline requirements in your engine manual for additional information.



 **CAUTION**

To conform to Federal Air Quality Standards, the petroleum industry reduced the amount of tetraethyl lead in gasoline. Alcohol is being blended with gasoline to help restore the octane rating lost when the lead was removed. While blending alcohol with gasoline increases the octane level of the fuel, it can also create certain safety and performance related problems for boaters.

A. Problems With Alcohol In Gasoline

Below is a list of problems which may be experienced when using blended gasoline.

1. Premature deterioration of fuel system components may occur. Alcohol will attack rubber fuel hoses, fuel tanks, fuel filters, fuel pumps and rubber gaskets. This deterioration will lead to fuel system leakage.
2. Phase separation of fuel will cause contamination. Water which accumulates in the tank through contamination or condensation will be absorbed by the alcohol. This water-heavy alcohol will settle at the bottom of the tank. This phase separation will lead to fuel tank corrosion. This may also result in a lean mixture to the carburetor and cause engine stalling or possible engine damage.

The use of alcohol additives in gasoline has become more wide-spread. Regulations on public notification of the existence of additives is currently controlled by the Environmental Protection Agency (EPA). Some states do require that gasoline pumps display information on additives (especially alcohol). If alcohol content is not posted, ask and avoid using fuel containing alcohol if possible.

B. Recommendations

Assume blended gasoline is being used and follow these recommendations below.

1. Inspect fuel hoses often. A deteriorated hose containing alcohol blended gasoline will normally be soft and swollen. A deteriorating hose containing no fuel will normally be hard

and brittle. In both cases the hose should be replaced.

2. Ventilate the engine compartment before starting the engine(s). Operate the engine compartment blower for four (4) minutes. Then, prior to starting the engine(s), check the bilge area for the scent of gasoline fumes; DO NOT start the engine(s) if the odor of gasoline is detected.
3. Frequently inspect the fuel system fittings. Inspect the fuel tank, pump and filter for signs of leaks or corrosion. Visually inspect for deteriorating metal fittings at the fuel hose connections.

 **WARNING**

Fuel leaks in hoses or at fittings are a fire hazard. If areas are found within the fuel system that appear questionable, have a qualified marine technician inspect the system. A thorough fuel system examination should be made by an experienced marine technician at least once a year.

F - 3 FUELING INSTRUCTIONS

1. Avoid fueling at night except in emergencies.
2. When moored at fueling pier:
 - a. Do not smoke, strike matches, or throw switches.
 - b. Stop all engines, motors, fans, and devices that could produce sparks.
 - c. Put out all lights.
3. Before starting to fuel:
 - a. Ensure that boat is moored securely.
 - b. Be sure the proper type and grade of fuel as recommended by your Engine Owners Manual is used.
 - c. Determine how much additional fuel is required to avoid overflow.



4. During fueling:

Keep the fill nozzle in contact with the fuel opening at all times to guard against possible static spark. See Figure F6.

 **WARNING**

Spilled fuel is a fire hazard. DO NOT overflow the tank or allow fuel spills into the hull or bilges. Avoid overboard spills. Visually monitor the fuel vent located on either the transom or side of the hull. When the tank is full, fuel will flow from the fuel vent.

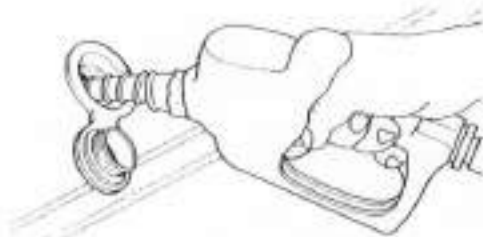

Grounding the fuel hose - Proper

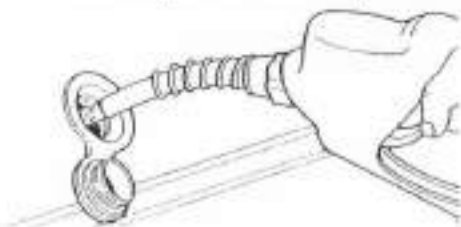

Not grounding the fuel hose - Improper

Figure F6: Grounding Fuel Hose

5. After fueling:

- a. Replace all fill caps securely.
- b. Wipe up any spilled fuel.
- c. Determine that there is no odor of gasoline in the engine compartment or below decks before starting machinery, turning on lights or lighting stove. Operate the bilge blower system for at least four (4) minutes before engine start-up.
- d. Be prepared to cast off moorings as soon as engine is started.



WATER AND WASTE SYSTEMS

G - 1 GENERAL

Some Four Winns models are equipped with a fresh water supply system. This system consists of a water supply tank, water distribution lines and a distribution pump. The water fill deck plate for the fresh water system is located on the deck. Always fill the tank slowly.

The approximate location of the water fill for each model is listed below.

Water Fill Location

MODEL	DECK WATER FILL LOCATION
214 C	Port, Forward of Sink
245 S	Port, Forward of Sink



CAUTION

The water deck plate is appropriately labeled. **DO NOT** fill the system with anything other than water. Should the system become contaminated with fuel or other toxic solution, component replacement may be necessary.

The water tank is equipped with an overboard vent. Maintain a close visual watch on the overboard vent while filling the water tank. Always fill the tank slowly. When the tank is almost full, water will spurt out of the vent.

NOTICE

When filling the tank, never seal the hose to the deck plate. The tank would become pressurized and could rupture.

The following is the capacity and location of water supply tanks.

NOTICE

DO NOT overfill the water tank. Tank damage may result. Water capacity and tank location may vary due to other equipment that may be installed on the boat.

Water Tank Capacities

MODEL	TANK CAPACITY	LOCATION
214 C	7 gal.	Port Bow Storage
245 S	7 gal.	Below Companionway Step

The materials from which the components of the water system are made may give the water supply a peculiar taste, especially when new. This condition is normal and can be reduced somewhat through the use of a water filter, such as that produced by Ametek Inc. Also, chemicals such as Sudbury's Aqua-Fresh and Pettibone's Aquabon are effective. The taste will completely dissipate in time.

G - 2 DISINFECTING THE WATER SYSTEM



WARNING

The fresh (potable) water system should be disinfected prior to initial use.

The water system should be disinfected before first use and at the beginning of each season. The following information is a general guide to disinfecting the fresh water system.

1. Flush the boat's water system thoroughly with fresh water. Make sure all anti-freeze is removed from the system.
2. The water system should be drained completely.
3. To disinfect the water system, use one gallon of water and 1/4 cup of Clorox or Purex household bleach (5% sodium hypochlorite solution). This is recommended for each 15 gallons of tank capacity.
4. Allow to stand for three (3) hours. If time is a factor, greater concentrations of chlorine solution will be needed to disinfect the water system.



5. Drain the system.
6. Flush the system thoroughly with fresh water.
7. Fill the system with fresh water.

To remove excessive chlorine taste or odor which might remain in the system, prepare a solution of one quart vinegar to five gallons water and allow this solution to agitate in the tank for several days during boating. Then drain tank and refill with fresh water.

The cockpit sinks are equipped with traps, and the water will drain slowly. If the system is not operating properly, have it checked by your authorized Four Winns dealer.

G - 3 FRESH WATER SYSTEMS

A. Cockpit Galley or Sink

The cockpit sink is available as an option 214 Candia and 245 Sundowner models. The water pump for the cockpit galley or sink is located below the sink on your Four Winns boat and will draw water when the switch is operated. The switch is located next to the faucet. After the tank has been filled, operate the pump switch until water comes out of the faucet.

NOTICE

If the line is routed improperly, kinked or is dislocated, the water pump may not operate properly. Inspect and correct the hose routing (if necessary). If a problem still exists, contact your Four Winns dealer for assistance.

After all the air has been purged from the system and a steady flow of water is coming from the faucet, turn off the pump.

NOTICE

DO NOT operate the pump with an empty tank. Damage to the water pump may result. Be sure the pump switch is off when not in use.

B. Transom Washdown

The transom washdown option is available on Sundowner models only. The washdown unit is located on the port side of the transom. The water supply system can be used for showering or washdown purposes at the transom. See Figure G1.

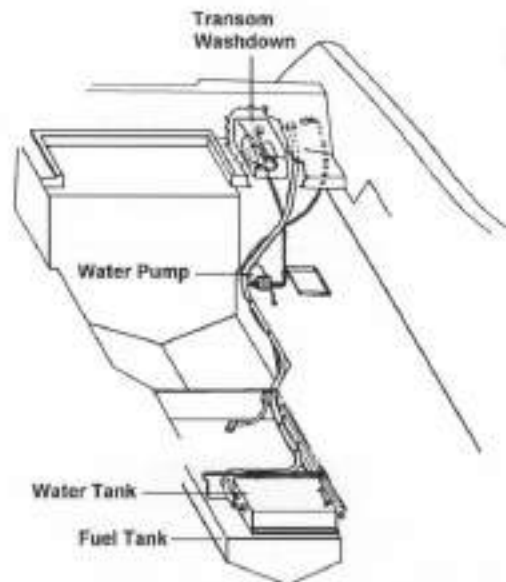

Figure G1: Transom Washdown

The fresh water tank has a seven gallon capacity and is located beneath the fuel tank lid. The water fill deck plate is located at the transom on the port side.

A separate toggle switch to operate the pump is located at the transom and is wired directly to the battery. An in-line fuse is included to protect the water pump. The pump is located in the rear engine compartment on the port side.

Models equipped with the transom washdown option will have a separate pump. With the pump switch "ON", push the spray nozzle button to purge any air that may be in the system. When a steady flow of water is coming from the washdown nozzle, release the spray nozzle. As the pressure builds, the pump will automatically shut off at 35 psi.



When properly primed and activated, the pressurized water system can be used in the same manner as the water system in a home. An automatic pressure sensor in the water pump keeps the system pressurized. Simply operate the spray nozzle and water will be delivered. If the system has been recently filled, or has not been used for an extended period of time, air bubbles may accumulate at the pump. If this should happen, re-priming may be necessary.

G - 4 GREY WATER SYSTEM

The grey water system is optional on 214 Candia and 245 Sundowner models. Water from the cockpit galley or sink will drain into a separate tank. A pump-out fitting labeled WASTE but designated for grey water is provided on the deck.

Generally, the grey water tank will be located in the same area as the water tank.

NOTICE

Certain geographical areas have restrictions on grey water being pumped or drained overboard. Be sure to check all local, state and federal laws in the boating area.

G - 5 HEADS

Portable heads are available on the Candia (Sunsport models only), 240 Horizon and all Sundowner models. The portable head used on Four Winns models has separate water and waste holding tanks built into the unit.

A. Candia Head (Sunsport Models Only)

The head is located aft, under the port sundeck lid. A privacy curtain is installed on the underside of the sundeck lid. Refer to Figure G2.

To set up the privacy curtain, follow the steps below.

1. Raise the sundeck lid to the open or vertical position. The gas shock will keep the lid open.

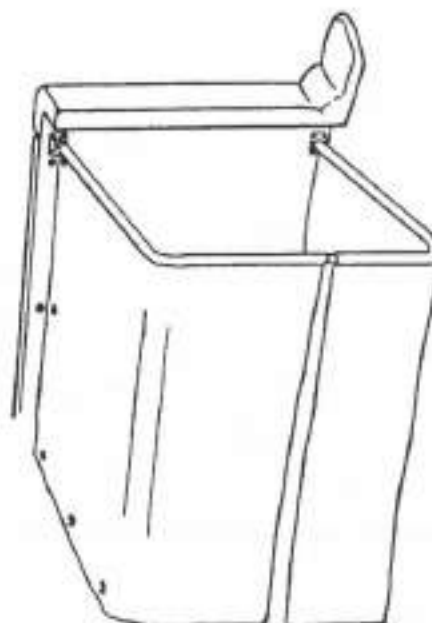

Figure G2: Privacy Curtain

2. Lift the privacy curtain rod. The spring stay will lock in the upright position. To unlock, push the spring at midpoint.
3. Snap the curtain to the sides of the engine compartment.

A zipper is provided in the front of the privacy curtain for access.

B. Enclosed Head (245 Model Only)

On the 245 Sundowner, there is an enclosed head as standard equipment. It includes a storage cabinet, hanging locker and privacy curtain (not shown). The porta potti stores below the hinged cushion. See Figure G3.

C. Pump Out Option

When equipped with the pump out option, the waste can be removed from the tank at a pumping station. A deck plate fitting labeled WASTE, is provided for this purpose. The pump out option is available only on Sundowner models. Most marina fueling facilities provide service for waste pump out. See Figure G4.



Figure G3: 245 Sundowner Enclosed Head

To pump out the holding tank.

1. Connect the dockside pump out connection to the WASTE plate located on the deck.

Usually the dockside pump out connection will screw into the waste deck plate or has a rubber sleeve that inserts into the plate and must be held in position during the pump out operation.

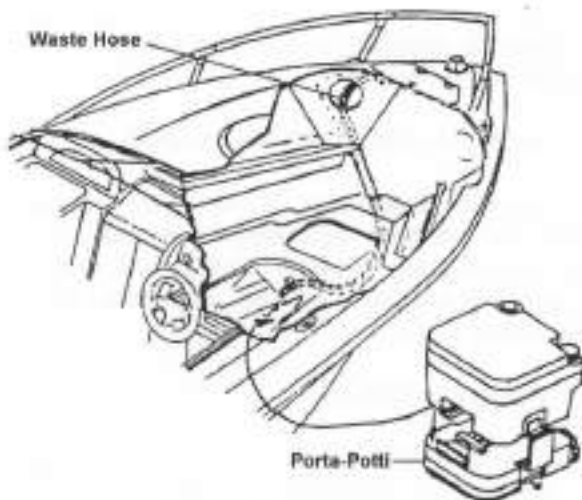

Figure G4: Head Pumpout

2. Have the pumping station operator activate the pumping equipment. The waste will be drawn from the holding tank and into the pumping stations disposal tank.

3. Remove the pump out connection from the deck plate. Add 1 gallon of clean water to the holding tank through the waste deck fitting using a dockside water hose.
4. Repeat steps 1 & 2 above to pump out the water used in step 3 to flush the holding tank.
5. Add waste holding tank treatment chemical available from the dockside pumping station operator to the head. Flush at least twice.

CAUTION

Be careful when handling and storing treatment chemicals. Not only are they toxic, but they will also stain and damage surrounding surface.

It will be necessary to remove the top holding tank of the portable head to fill with water.

G - 6 LIVEWELL

The livewell is optional on Freedom and Horizon models. It is included with the Fish and Ski option and has a capacity of approximately 15 gallons.

The livewell comes equipped with an aerator pump which is operated from a switch on the dash. The water is aerated as it is pumped into the tank. A hatch is included for access and the tailpiece regulates the water level. To drain, remove the tailpiece as shown in Figure G5.

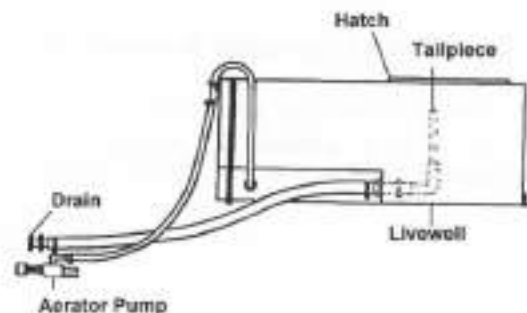

Figure G5: Livewell



G - 7 SYSTEM MAINTENANCE

Be sure the batteries in the boat are properly charged. Operating the pressure pump from a battery with a low charge will result in pump cycling. This could lead to premature pump failure.



WARNING

The decomposition of waste produces a colorless, odorless gas, methane, that is lighter than air, combustible, and extremely lethal. Always provide sufficient ventilation when effecting repairs to the waste system and allow no odor from the waste system to go un-resolved.

A. Clean Vents and Screens

Periodically remove the vent caps and check the water tank vent(s). Clean the thru-hull vent fitting(s) of any dirt, wax, plastic particles, etc. Always replace the caps after cleaning.

NOTICE

Failure to keep the water tank vent fitting clean will cause excessive pressure buildup within the tank during filling. This can cause water tank damage.

B. Winterizing the Water System

Winter lay-up service procedures should include a thorough draining of the water system. Disconnect all accessible fittings. Blow out all lines. Be sure the water tank, waste tank, pumps and lines are completely dry. Freezing water can cause severe damage to all water system components.

NOTICE

It may be necessary to disconnect the hose below the faucet to remove excess water in the lines to prevent freeze damage.

NOTICE

Always winterize the fresh water system prior to winterization of the hull drainage (bilge pump) system.

Draining the system as mentioned can be very tedious and an incomplete job can result in expensive repairs. The use of non-toxic anti-freeze (such as R.V. anti-freeze) designed for fresh water systems considerably reduces the work necessary and is a more positive means of winterizing the system. Follow the directions included with the anti-freeze solution.

To winterize:

1. Turn on the water pump/faucet and drain the water tank. The water tanks on some models can be drained by removing the withdrawal hose from the tank and allowing water to drain into the bilge.

NOTICE

DO NOT run the water pump without water in the system. Pump damage can result. Be watchful and turn the pump off as soon as the tank becomes empty.

2. Add 1/2 gallon of R.V. anti-freeze to the water tank.
3. Turn ON the pump until undiluted antifreeze is seen.



DANGER

Use only non-toxic anti-freeze solutions such as R.V. anti-freeze. DO NOT use ethylene glycol solutions; the type that is used in engine coolant systems. These are toxic.

NOTICE

Be sure to wipe up any anti-freeze that has been spilled on the fiberglass surfaces to prevent possible discoloration or damage to the gel coat.

Depending upon options and model, additional information by the equipment manufacturers is included with this manual. Also, refer to Section O on Maintenance.



VENTILATION & DRAINAGE SYSTEMS

H - 1 ENGINE COMPARTMENT VENTILATION

All Four Winns stern drive models are equipped with engine compartment ventilation. This system is designed to meet or exceed the requirements (in effect at the time of manufacture) of the U.S. Coast Guard, the National Marine Manufacturers Association, and the American Boat and Yacht Council.

A. Gravity Ventilation System

This system includes air intake and exhaust components. The exhaust ducting reaches to the lower bilge area. This provides adequate air movement while underway and during bilge blower operation.

B. Forced Air Ventilation

All Four Winns models except outboards are equipped with an electric bilge blower. The bilge blower provides the ventilation required prior to starting the engines and while at idle. See Section E Electrical Systems for blower operation instructions.



WARNING

Before starting the engine, operate the engine compartment bilge blower for four (4) minutes. Then check the engine compartment for gasoline vapors. ALWAYS operate the bilge blower while the engines are at idle. Failure to comply could cause explosion and thereby inflict serious injury.

NOTICE

A Gas Vapor Detector is a monitor which will alert the operator of an accumulation of gasoline fumes in the engine compartment. It is optional only on larger models but can be installed by your Four Winns dealer. DO NOT rely solely on detectors or similar equipment. ALWAYS conduct a physical inspection of the engine compartment.

C. Engine Ventilation System Maintenance

Periodic inspection and cleaning of the ventilation ducts is necessary to ensure adequate air circulation. A build-up of leaves, twigs, or other debris can severely reduce ventilation. Be sure bilge water does not accumulate to a level that would obstruct the ventilation ducts.

Blower operation can be tested by placing a hand over the vents. DO NOT rely on the sound of the blower. Be sure a substantial amount of air is being exhausted by the bilge blower. Check the bilge blower system often, preferably before each cruise.

Should blower noise and vibration be excessive, loosening the bilge blower mounting screws and then tightening evenly usually reduces noise considerably.

H - 2 CABIN VENTILATION

Deck hatches on Four Winns Sundowner models are designed to open and provide adequate ventilation in the cabin berth area.



WARNING

Failure to properly ventilate the boat while the engine is operating may permit carbon monoxide to accumulate inside of the cabin. Refer to Section B-2 Engine Exhaust and Section H-4 Carbon Monoxide for additional information.

Screens for the deck hatches are available as an option. The screen will attach with velcro from inside the cabin.

NOTICE

DO NOT close the deck hatch with the hatch screen in place. Damage to the screen can result. Be sure deck hatch is secured while underway. Damage to the hatch may result.



In time, the color on certain plastic deck hatch and port hole assemblies may fade or become weathered. The surface oils in the plastic are removed due to exposure. This is normal. The deep, rich color can easily be restored by periodic applications of mineral oil or silicone lubricant.

H - 3 HULL DRAINAGE SYSTEMS

A. Transom Drain

A transom drain with plug is provided in the engine compartment to allow water drainage. When the boat is out of the water, the boat and trailer should be positioned so any bilge water accumulation during dry storage will flow towards the transom.



CAUTION

Be sure the drain plug is securely in place prior to launching the boat. Upon shipment of the boat, the drain plug is usually taped to the steering wheel.

B. Bilge Pumps

Bilge pumps are provided in the bottom of the hull to remove miscellaneous water accumulations that might occur during normal boating or weather conditions. The bilge pump is controlled by the Bilge Pump Switch on the dash panel (see Section E-3 for a detailed description of the bilge pump switches).

Bilge pumps equipped with automatic switches are optional on most models. As the water level rises, the automatic float switch will activate the pump.

If a dual battery switch is installed, a separate circuit breaker is provided on the panel to supply power directly from the battery(s) regardless of battery selector switch position.

When leaving the boat unattended for long periods of time or during excessive rain storms, it is a good idea to check on the boat for excessive water accumulation. Be sure the bilge pump and automatic float switch (if equipped) are

operating properly. The operating time of the bilge pump will be limited to the battery capacity.

NOTICE

While at rest, any bilge water accumulation may flow forward. Therefore, operate the bilge pump shortly after getting underway and while the boat is at a substantial running angle. **DO NOT** allow bilge water to accumulate. Damage to the engine or other components may result.

Periodically, clean the bilge pump strainers. **DO NOT** allow dirt and debris to clog the bilge pump intakes. Check operation of the bilge pump float switch often to ensure movement of the switch is not restricted by debris, portions of the hull, etc.

Wipe up any oil accumulation in the bilge prior to activation of the bilge pump. Pumping oil overboard will pollute the water, and is subject to fine.

After winterization of the fresh water systems, be sure the bilge area, bilge pump and associated hoses are thoroughly dry. Damage to the hull, bilge pump and other equipment could occur if water is allowed to freeze in the bilge.

C. Liner Drains

Liner drains are provided on models with fiberglass liners or floors. Fiberglass liners can be cleaned easily by hosing the floor. The water will drain into the bilge and be pumped overboard.

D. Bilge Compartment Drainage

Certain bulkhead areas of Four Winns boats are sealed in accordance with U.S. Coast Guard regulations effective at the date of manufacture. Drainage is provided and water can be removed with the bilge pump.

H - 4 CARBON MONOXIDE

Carbon monoxide accumulation is affected by vessel geometry; hatch, window and door openings; ventilation openings; proximity to other structures; wind direction; vessel speed; and a multitude of other variables. The technical information included in this section is to inform the



boat owner of possible cause and effects of carbon monoxide. This information has been reprinted with permission from the American Boat and Yacht Council's (ABYC) technical information report: "Educational Information About Carbon Monoxide". This information pertains to all boats manufactured by Four Winns.

NOTICE

The boat owner should be aware that other factors may contribute to carbon monoxide accumulation. The most common ones are listed in this section. If a person is exhibiting carbon monoxide-type symptoms (Refer to Section F Symptoms), be sure to take the necessary precautions as prescribed later in this section.

NOTICE

Boats fueled by diesel have limited carbon monoxide present in the exhaust in comparison to gasoline engine exhaust. However, the boat owner should still be aware of the causes and effects of carbon monoxide which may occur in different boating situations.

A. Definition of Carbon Monoxide

1. Carbon Monoxide: Carbon Monoxide (CO) is a gas formed by the combination of one molecule of carbon and one molecule of oxygen. Chemists refer to it as CO, its chemical formula, "C" for carbon and "O" for oxygen.
2. COHb: Carboxyhemoglobin is the molecule formed when Carbon Monoxide combines with blood instead of oxygen.

B. Properties and Characteristics of Carbon Monoxide

1. Carbon Monoxide is a colorless, odorless and tasteless gas.
2. Its weight is about the same as air so it cannot be expected to rise or fall like some other gases, but will distribute itself throughout the space.

NOTICE

DO NOT rely on the use of smell or sight of other gases to detect CO, because it diffuses in the air much more rapidly than easily detectable (visible and smellable) gases.

C. What Makes Carbon Monoxide

Any time a material containing carbon burns such as gasoline, natural gas, oil, propane, coal, or wood, CO is produced.

Common sources of carbon monoxide are:

1. Internal combustion engines.
2. Open flame devices such as:
 - a. Cooking ranges
 - b. Central heating plants
 - c. Space heaters
 - d. Water heaters
 - e. Fireplaces
 - f. Charcoal grills

D. How a Person is Affected by Carbon Monoxide

Carbon monoxide is absorbed by the lungs and reacts with blood hemoglobin to form carboxyhemoglobin, which reduces the oxygen carrying capacity of the blood. The result is a lack of oxygen for the tissues with the subsequent tissue death and, if prolonged, death of the individual.

E. Effects of Carbon Monoxide

Carbon monoxide in high concentrations can be fatal in a matter of minutes. Lower concentrations must not be ignored because the effects of exposure to CO are cumulative and can be just as lethal.

Certain health related problems and age will increase the effects of CO. People who smoke or are exposed to high concentrations of cigarette smoke, consume alcohol or have lung disorders or heart problems, are particularly susceptible to an increase in the effects from CO. However, all occupants' health should be considered. Physical exertion accelerates the rate at which the blood absorbs CO.



F. Symptoms

One or more of the following symptoms can signal the adverse effect of CO accumulation:

1. Watering and itchy eyes
2. Flushed appearance
3. Throbbing temples
4. Inattentiveness
5. Inability to think coherently
6. Ringing in the ears
7. Tightness across the chest
8. Headache
9. Drowsiness
10. Incoherence
11. Nausea
12. Dizziness
13. Fatigue
14. Vomiting
15. Collapse
16. Convulsions

NOTICE

The order of the above list is generally the sequence of appearance of symptoms. However, the order of appearance may change for different people.

NOTICE

The symptoms of Carbon monoxide poisoning may easily be mistaken for seasickness.

G. Treatment (Evacuate, Ventilate, Investigate, Take Corrective Action)

1. Move the person to fresh air.
2. Administer oxygen if available.
3. Contact Medical help.
4. If the victim is not breathing, perform artificial respiration per approved CPR procedures until medical help arrives and takes over.

NOTICE

Prompt action can make the difference between life and death.

5. Ventilate area.

6. Investigate source of CO and take corrective action.

H. Inspection

Look and listen for leaks in the exhaust systems of both the generator and propulsion engine(s). Look for discoloration around joints in the system (water leaks, carbon, stains, etc.).

1. Make sure all exhaust clamps are in place and secured.
2. Make sure ventilation systems work and are not obstructed or restricted.
3. Make sure gaps around the engine room plumbing and cableways and exhaust system doors, hatches, and access panels are minimized to reduce the opportunity for CO to enter the accommodation spaces(s).

I. Operation

Cold Start vs. Warm Start: CO production is greater while the combustion chamber surfaces and gas passages are cold versus when they are warm. A boat operator should:

1. Pay attention to ventilating the boat.
2. Orient the boat so it will allow the maximum dissipation of CO.
3. Minimize the time spent on getting underway.

J. Boathouses, Sea Walls and Other Boats

A boat operator should be aware that dangerous concentrations of CO can accumulate when a boat, generator or other engine operated device is operated while the boat is moored in a confined area such as:

1. Boathouses,
2. Proximity to sea walls, or
3. Proximity to other boats.

Orient the boat for maximum dissipation of the exhaust or DO NOT run the boat or boat equip-



ment for extended periods under these conditions. See Figure H2.



Figure H2: The effect of sea walls and other confined spaces.

A boat operator should be aware that carbon monoxide is emitted from any boat's exhaust. The operation, mooring, and anchoring in an area containing other boats may be in an atmosphere containing CO not of the operator's making. An operator likewise needs to be aware of the effect of his actions on other boats. Of prime concern is the operation of an auxiliary generator with boats moored along side each other. Be aware of the effect your exhaust may have on other vessels and be aware that the operation of other vessel's equipment may affect the carbon monoxide concentration on your vessel. See Figure H3.

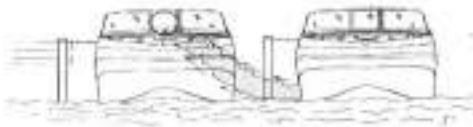

Figure H3: The effect of boats moored along side.

K. Backdrafting (Station Wagon Effect)

Backdrafting or the "station wagon effect" is caused by air movement over or around a boat creating a low pressure area of suction area around the stern which can increase CO level on the boat. Backdrafting can be affected by relative wind direction, boat speed, and boat trim angle. See Figure H4 Backdrafting - Airflows Over Boat and Behind Transom".

Under certain speed and operating conditions the low pressure area may form in other regions and permit carbon monoxide to enter the hull through

openings that are not on the back of the vessel. Boat factors which may affect CO concentration:

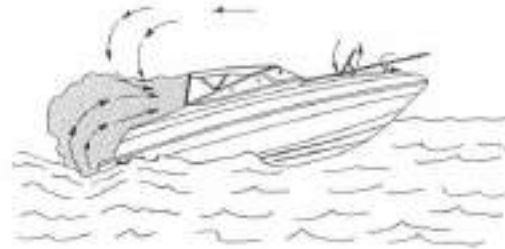

Figure H4: Backdrafting - Air flows over boat and behind transom.

1. Inefficient trim angle. See Figure H5.
2. Excessive or unequally distributed weight.

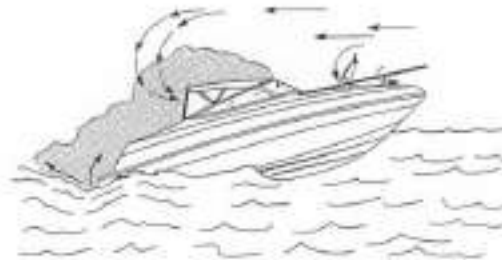

Figure H5: Inefficient trim angles.

3. Canvas Configurations - Under various conditions, adding or removing canvas may raise or lower CO levels. See Figures H4, H5 & H7.
4. Opening and closing ports, hatches, doors, and windows may raise or lower CO levels on board a boat. See Figures H6 and H7.



Figure H6: Desired air flow through the boat.



Figure H7: The effect of canvas configurations.

L. Cabin Appliances

Boats having fuel burning appliances in accommodation areas should be provided with adequate ventilation and maintained to function properly.

M. Ventilation of Accommodation Spaces

Accommodation spaces need to be ventilated to introduce fresh air into the spaces. Ventilation method; e.g. windows, hatches, doors, and blowers; used to accomplish this may, under certain conditions, bring hazardous levels of CO into the accommodation spaces. Care should be taken to be aware of all prevailing conditions when using these ventilating methods.

N. Altitude and Sea Conditions

Changes in altitude greater than 5,000 feet contribute to inefficient engine performance and may require adjustments to the ignition systems, fuel systems, or changing the propeller's size.

1. Failure to make adjustments to ignition systems, fuel systems, and propeller size may cause an increase in CO production.
2. Heavy sea conditions tend to load engines resulting in reduced performance and thereby increasing their CO production.

O. Portable Generator Sets

Gasoline powered portable generator are available in the marine market place and is not an option available through Four Winns. The portable generator will produce CO. These sets discharge their exhaust products in locations which can lead to an increase in the

accumulation of carbon monoxide in the accommodation space. This equipment is not recommended for use on Four Winns boats.

P. Maintenance - Engine Performance

Efficient engine performance is vital to minimizing CO production. The following items are those considered to have the greatest effect on increased CO production:

1. Fuel Systems - Fuel that is contaminated, stale or incorrect octane number.
 - a. Dirty or clogged flame arrester.
 - b. Malfunctioning automatic choke plate or faulty adjustment of manual choke plate.
 - c. Worn float needle valve and seat.
 - d. High float level.
 - e. Incorrect idle mixture adjustment.
 - f. Dirty or worn injectors.
3. Ignition System
 - a. Fouled or worn spark plugs.
 - b. Worn points or incorrect gap on points.
 - c. Shorted or opened circuit high tension spark plug cables.
 - d. Incorrect ignition timing.
4. General
 - a. Worn piston rings and valves.
 - b. Engine temperature - Cold running engines increase CO production. Engine cooling water system design and selection of thermostat(s) are primary considerations affecting engine operating temperature. Generally, an engine produces less CO if it operates at a relatively high temperature within manufacturer's specifications.



- c. Exhaust Back-Pressure - Certain alterations to the exhaust system may increase engine exhaust back pressure and CO production.
- d. Restricted engine room or compartment ventilation.

Q. Maintenance - External Conditions

External conditions that contribute to inefficient engine performance are:

1. Fouled hull bottom.
2. Damaged and fouled running gear (propeller and trim tabs).
3. Incorrect selection of propeller size.

R. CO Detection Systems

Carbon Monoxide (CO) Detectors are optional equipment on the Sundowner models only. This may also be installed by your Four Winns dealer.

NOTICE

For information on CO Detection Systems, see American Boat and Yacht Council (ABYC Manual) Section A-24, "Carbon Monoxide Detectors".

Even with the best of boat design and construction plus utmost care in inspection, operation, and maintenance, hazardous levels of CO may still be present in accommodation spaces under certain conditions. Continuing observation of passengers for symptoms of CO intoxication can be supplemented by an alarm type CO detection device in the accommodation space.

Current CO detector technology can be broken down into three major categories: single-point, multi-point, and fully-integrated; the difference being the degree to which each type of unit considers exposure time.

1. Single-point Detection: The single-point detector will sound the alarm whenever the detector senses that a single pre-set PPM (Parts Per Million) level of CO has been exceeded.

2. Multi-point Detection: The multi-point detector alarm will sound at a number of selected CO levels. The multi-point detector may include several different measuring time periods with their corresponding different PPM CO level alarm settings.
3. Fully-integrated Detection: The fully-integrated detector will sound an alarm to any combination of PPM CO level and exposure time that would cause a health hazard.

Detection devices should meet the requirements of ABYC A-24 "Carbon Monoxide Detection Systems on Boats".



INTERIOR EQUIPMENT

I - 1 BUTANE STOVE

CAUTION

Care must be exercised while around stoves and other appliances. Keep children away from burners.

The butane stove is optional only on the 245 Sundowner model. It is equipped with a single burner. Refer to the manufacturer's manual for additional information.

WARNING

To prevent skin burns, be careful while lighting and operating your stove. Be sure the stove is off and cools totally before storing.

I - 2 GLOVEBOX

The glovebox is located on the port side on all models. It allows for storage of valuables under lock and key. See Figure I1.

I - 3 IN-DASH COOLER

Most models are equipped with an in-dash cooler for storage of soft drinks. The excess water from melting ice will drain overboard. The lid consists of starboard and includes a finger-pull type latch to allow easy access. See Figure I1.

I - 4 ICE BOX

The ice box is available with the cockpit galley option only on the 245 Sundowner model. The ice box functions similar to a portable cooler. Adding ice (preferably block ice) will keep food cold for a long period of time. The excess water from melting ice will drain overboard.

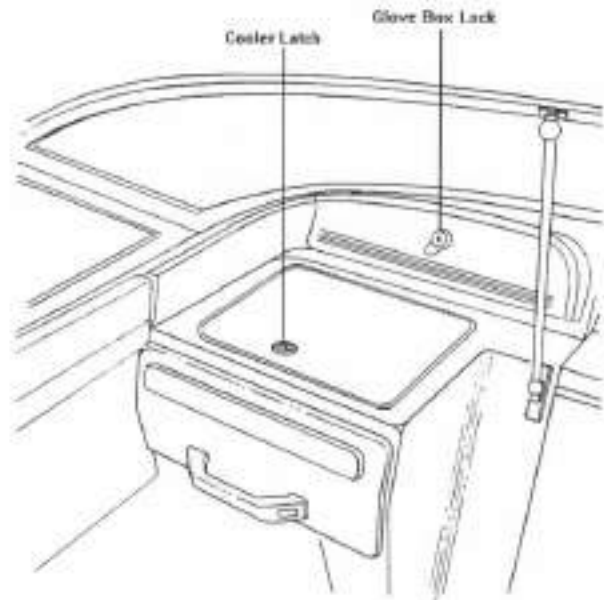

Figure I1: In-Dash Cooler & Glove Box

I - 5 REFRIGERATOR

Refrigerators are optional with the cockpit galley on the 245 Sundowner model. The refrigerator will operate on the 12 volt system only. In general, the refrigerator will cool more slowly when compared to operation on 120 volt systems. Making ice cubes may be difficult on a warm day unless the unit is operated when the engine is running.

Care should be exercised while operating the refrigerator on the 12 volt system. The refrigerator requires a substantial amount of current. Excessive current draw can severely drain a battery through extended use. Be sure to limit battery usage with the battery switch which is required with this option. The refrigerator is wired to battery #2 or position "2" on the battery switch. It will utilize both batteries when set on the "ALL" position. Refer to E-2c Battery Switch Operation for additional information.



NOTICE

Before installing dockside or a shore power battery charger (not a Four Winns option), refer to the refrigerator owner's manual. Damage to the refrigerator may occur from improper installation.

I - 6 STEREO

Four Winns offers an AM/FM cassette stereo as standard equipment on all models. The stereo is mounted within a plastic box to protect it from the elements. The radio box has a sliding door to allow access to the controls.

The speakers are installed within coaming (side upholstery) pads, seat bases, or cabin depending upon model and type of interior.

For additional information on stereos, refer to the manufacturer's literature included with this manual.

I - 7 SL PACKAGE

A new option on Horizon and Sundowner (except 195) models is the wood grain accent or SL package. This consists of finished mahogany for the steering wheel, dash panels, and glovebox door to accent the cockpit. For care and upkeep information, refer to Section N-4 Mahogany in this manual.



EXTERIOR AND SAFETY EQUIPMENT

J - 1 RAILS & DECK HARDWARE

A. Rails

Hand rails have been installed to provide security for passengers in the cockpit. Limiting passenger movement while underway is recommended. All those on board should be safely seated whenever possible. Additional care must be taken when in rough seas or foul weather.

The rail system and hardware fittings have been selected and installed to perform specific functions. Fenders or mooring lines should not be secured to the rails or stanchions. Be certain that a clear lead exists when running dock lines or an anchor line. A line inadvertently threaded around a stanchion or over the rail could cause damage.

B. Cleats

The cleats that have been installed are specifically designed and are intended to be used as mooring cleats. Their purpose is for securing the vessel to a dock, pier, mooring, or anchor.

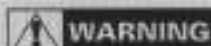

WARNING

Four Winns Boats are not equipped with any hardware designed for towing purposes. The mooring cleats that are installed on the boat are not to be used for towing another vessel or having the boat towed. Refer to Section Q Operation for additional precautions regarding grounding and towing.

C. Transom Ski Tow Ring

The transom ski tow ring is mounted on the transom above the integrated platform. It is available on all models except outboards. On models with the 3.0 Litre engines, the boat will normally pull up one skier. All other models should pull up two skiers under normal boating conditions. However, Four Winns recommends no more than two skiers be pulled behind the boat at any time.

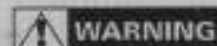

WARNING

To prevent personal injury or damage to the boat, DO NOT use ski tow ring for lifting or parasailing.

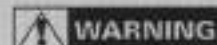

WARNING

To prevent personal injury or damage to the boat, DO NOT tow more than two water skiers with the transom mounted ski tow ring.

NOTICE

Skier(s) weight, boating conditions, amount of gear, and operator's experience will affect the number of skiers which can be pulled.

D. Ski Pylon - Outboard Models

The ski pylon is an option for the 190 and 200 Horizon and 205 Sundowner Outboard models. The ski pylon is mounted at the transom. The legs and center post may be disassembled for easy storage. See Figure J1.

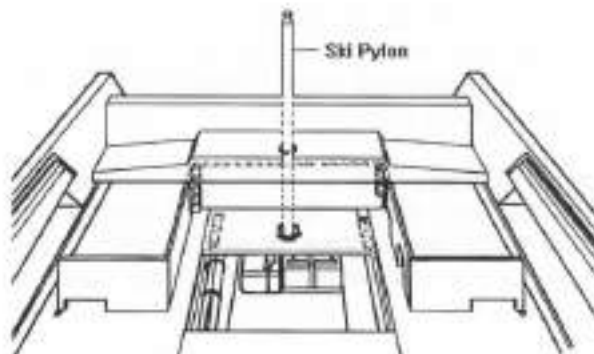

Figure J1: 200H/205S Ski Pylon

E. Anchor Locker

Most models come equipped with hinged anchor lockers for storage of the line (rode) and anchor. To open, lift the latch. The compartment should be inspected after each use, and kept cleaned of dirt and debris to prevent plugging of the drain

hole. For information on anchors, refer to Section J-5.

F. Maintenance

The majority of the hardware installed is made of stainless steel. Regardless of the type of hardware used, periodic maintenance is necessary.

The manufacturer of our hardware recommends the following when washing your boat:

1. Rinse the hardware with fresh water after each exposure to saltwater.
2. Periodically wash the hardware with mild soap, warm water, and a sponge. Then dry it with a soft cloth.
3. Avoid cleaners, abrasives, waxes, and most of all, do not use steel wool.

NOTICE

All fittings must be periodically inspected for loosening, wear, and damage. Problems should be corrected immediately!

J - 2 WINDSHIELDS

A. Windshields

The windshield on all models is standard equipment except on the 214 Candia. Windshields consist of tempered safety glass and the windshield frame is aluminum.

On windshields with walk-through window, the manufacturer (Water Bonnet) has patented a slider hinge which allows for easy removal of the center windshield section. The "Versa hatch" is a new product. A drawing of the slider hinge mechanism is shown in Figure J2, and instructions for hatch removal are listed below.

To remove hatch:

1. Open hatch 30° to 45°
2. Slide sliders up.
3. Carefully remove hatch. Storage bags are available as an option.



Figure J2: Versa Hatch Slider Hinge

To replace hatch:

1. Assure sliders are in "up" position.
2. Insert hatch in proper position.
3. Slide sliders down securely. It will "click".
4. Check to insure hatch is securely locked in place by opening and closing.

Windshields of tempered glass can be cleaned with automotive glass cleaners or dishwashing soap and water. Refer to Section J-3c for instructions on cleaning acrylic.

Aluminum can be cleaned with similar products or with non-abrasive cleaners such as Fantastic.

NOTICE

Read the label before using any product. DO NOT use abrasive cleaners.

J - 3 COMPANIONWAY

A. Companionway

The companionway door is comprised of acrylic or plexiglass on cabin models. The hatch lid is fiberglass on all Sundowners except the 195 model, which does not have a lid. See Figure J3.

NOTICE

To prevent damage to the companionway, ALWAYS open the hatch lid before opening the door.

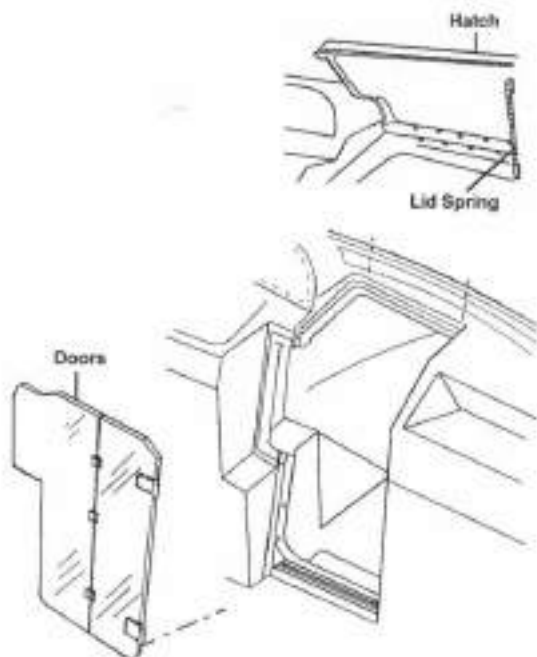

Figure J3: Companionway Door

The companionway hatch is equipped with slam latches on all Sundowners except the 195 model. A standard lock is installed on the starboard door of the 195 model. To unlock a slam latch, turn the key to unlock. Then push the center portion of the latch and lift up on the hatch.

The companionway doors will open freely after the hatch is lifted open. A strap is provided to secure the doors open. The lid spring will secure the hatch open. To close, push in on the middle of the spring and close the hatch.

On all Sundowner models (except 195), the doors can be lifted out and stored on the floor next to the boat operator. See Figure J4.

These models are equipped with sliding hinges and need to be removed from within the cabin. Please use the following steps to remove the doors.

1. Push the starboard cabin door inward to cause the door assembly to fold.
2. Lift the door up parallel to the bulkhead or companionway opening. A handle is provided on the inside of the door. The door will slide up along the hinges.

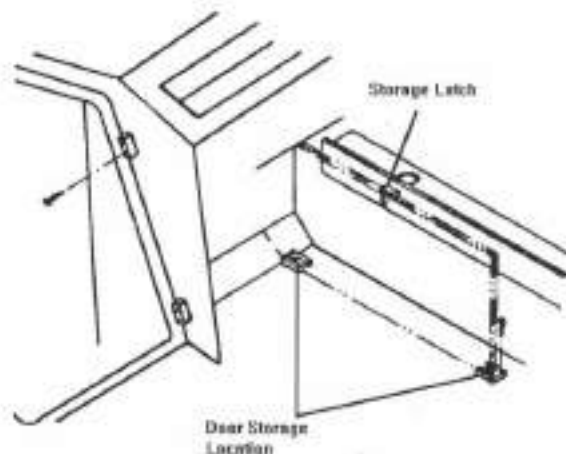

Figure J4: Companionway Door Storage

NOTICE

Companionway hatches and doors should be secured when the boat is in motion. This will prevent any possible breakage resulting from bouncing, hitting waves, etc.

B. Deck Hatch

Deck hatches are composed of plastic or plexi-glass material inside an aluminum frame. Hatch screens are available as an option through your Four Winns dealer.

The deck hatch is secured with three handles as shown in Figure J5. The hatch support arm can be adjusted to an open or partially open position. To adjust the hatch, loosen the coupler and open the hatch to the desired position. Then, tighten the coupler to secure the hatch.

NOTICE

DO NOT close the deck hatch with the hatch screen in place. Damage to the screen can result. Be sure the deck hatch is secured while underway. Damage to the hatch may result.

C. Acrylic Maintenance

Acrylic is used for console windshields, companionway door assemblies, sliding storage doors, cabinets, deck hatches, and some windshield



sections. Acrylic will scratch easily and must be handled with care.

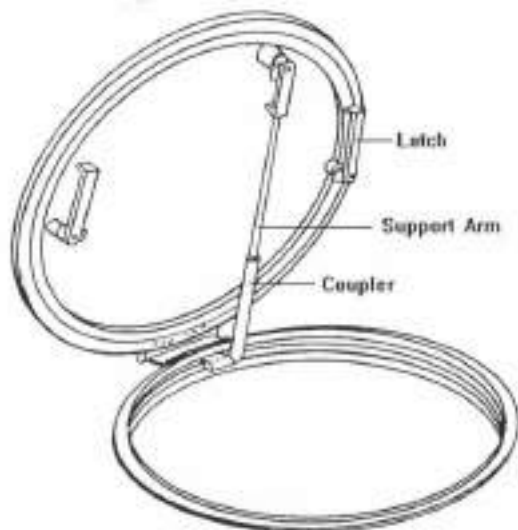

Figure J5: Deck Hatch

To clean, wash gently with dishwashing soap and water. Rinse thoroughly with plenty of clean lukewarm water. To dry, use a clean soft cloth and apply light pressure. Chamois cloth can also be used. DO NOT use paper towels. They will scratch the acrylic.

Acrylic or plastic polish may also be used. Our acrylic supplier recommends a product manufactured by Novus, Inc. called "Novus Plastic Polish". This product is an anti-fog, anti-static, and dust repellent cleaner for all plastic surfaces. Total Plastics, Inc. is a local distributor of Novus Plastic Polish and can be purchased by calling 800-289-3232. Read the label first before using any cleaning product.

Grease, oil or tar may be removed with a good grade of hexane, aliphatic naphtha, or kerosene. These solvents may be obtained at a paint or hardware store. Read the label first before using any cleaning product.

Any oil film left behind by solvents should be removed immediately by washing with mild soap and water.

NOTICE

DO NOT USE window cleaning sprays, kitchen souring compounds, or solvents such as acetone, gasoline, benzene, carbon tetrachloride, lacquer thinner, harsh chemicals or strong cleaning solutions on acrylic. The surface can be etched, scratched, disfigured, or clouded.

Static electricity can attract dust to acrylic. To reduce it, use an anti-static cleaner such as Novus Plastic Polish or consider using an anti-static gun, which can be purchased locally at stores specializing in stereo equipment.

Additional information on maintaining acrylic material is included with this manual.

J - 4 SWIM PLATFORM

Four Winns provides an integrated fiberglass swim platform on all models. For better footing, a non-skid surface is provided. The ladder is located for easy access when boarding.

WARNING

Keep hands and fingers away from ladder hinges to prevent injury.

WARNING

To prevent personal injury, **DO NOT** use the boarding ladder or swim platform while the engines are running or while the boat is in motion. Engines must be off when using the swim platform or boarding ladder.

NOTICE

When lowering or raising the ladder, the drive or outboard engine must be turned away (port or starboard depending upon the model) to clear the ladder. Damage to the ladder may otherwise result. Always secure the ladder before boating.

J - 5 BOW ROLLER

The bow roller is an option on all Sundowners except the 195 model. The bow roller allows for storage of the anchor at the bow. The rope should be secured to a cleat to keep the anchor up against the bow roller. See Figure J6.

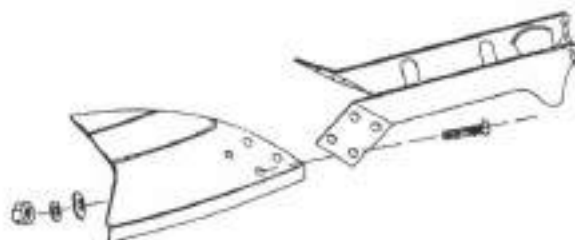

Figure J6: Bowroller Assembly

NOTICE

For field installation, consult your Four Winns dealer for information on proper reinforcement of fiberglass to install bow roller.

J - 6 ANCHOR

Four Winns recommends an eight (8) pound, "Danforth-type" anchor be used on all Sport boat models except the 245 Sundowner. Four Winns recommends a thirteen (13) pound anchor for the 245 Sundowner. Because of differences in style, a larger anchor may be needed for different bottom or boating conditions.

Anchors are usually a dealer installed option. Please check with your Four Winns dealer for his recommendations.

J - 7 NAVIGATIONAL EQUIPMENT

A. Compass

A compass is optional equipment on all Four Winns models except the Freedom model. It is a valuable piece of equipment when operating offshore, in unfamiliar waters, or in adverse weather conditions. The safety of those aboard the boat could, at some time, depend upon the compass and your navigational skills.

On models with the new style module, a cutout is provided for the compass and it is mounted on the shroud assembly as shown in Figure J7.

After all personal equipment is installed, including all electronics (radio, depth sounder, etc.), the compass must be properly calibrated. DO NOT rely on the compass readings until initial adjustment (compensation) has been performed. If the boat has a factory installed compass, the compass must be adjusted by the owner or mechanic prior to use. Refer to the manufacturer's instructions provided with this manual. Most areas have local companies that specialize in compass adjustment. If unsure of the proper compensation techniques, consider having the adjustment done professionally to insure accuracy and confidence in the compass.

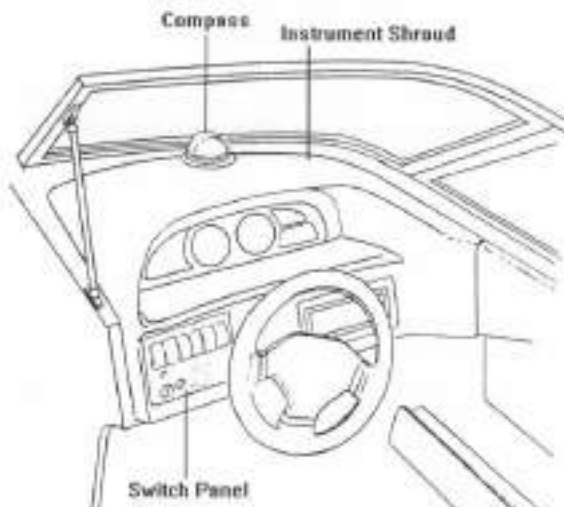

Figure J7: Horizon/Sundowner With Compass Option

NOTICE

During use, keep all extraneous metal objects away from the compass. The close proximity of metal objects (e.g., beverage cans) can cause compass deviation.

B. Depth Sounder

Depth Sounders are available as an option on all models except the Freedom. The depth sounder on the Horizon/Candia/Sundowner module will read depth only, and does not have an audible alarm.



NOTICE

Depth sounders provide a relative indication of water depth.

The transducer is factory installed and is water tested. It will be located in the bilge compartment to limit the effect of water turbulence while underway.

NOTICE

DO NOT depend solely upon the depth sounder for water depth. It is important to have navigational charts of the waters in which you are operating.

J - 8 FISHFINDER

The fishfinder is optional equipment on all Sport Boat models. The fishfinder mounts on the dash. If equipped, please refer to the manufacturer's literature for additional information.

NOTICE

With the fish finder option installed, the depth indicator will no longer function.

J - 9 SPOTLIGHT

A properly operating spotlight is essential for safe cruising at night. Four Winns offers a DC outlet as an option which can be used for portable spotlights. The spotlight is a dealer installed option.

J - 10 FIRE EXTINGUISHER SYSTEM

A self-contained, environmentally acceptable fire extinguisher system is available as an option on all Sport Boat models. If equipped, please refer to the manufacturer's literature for additional information.



UPHOLSTERY

K - 1 INTERIOR SEATING

A. Cabin Tables

Table bases are "flush" mounted for convenience. Table legs are removable for easy storage by lifting the leg from the base. Rotating the leg while lifting will ease the removal.

The v-berth table on cabin models has one table leg. The table may be stored behind the back-rests or under the v-berth cushions when not in use.

With the extra table option, another flush floor mount is installed in the aft cockpit area. The table can then be installed in either location.

B. V-berth Filler Cushions

Four Winns provides filler cushion(s) for the v-berth area on cabin models. The filler cushion(s) will either be supported by star board supports or will drop into place onto the forward carpeted bulkheads. This will provide additional berth area in the cabin area. See Figure K1.

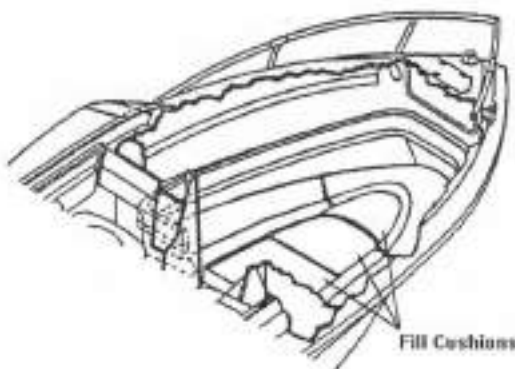

Figure K1: Filler Cushions

Storage is provided under the v-berth. The storage area is easily accessible under the cushions.

CAUTION

To prevent personal injury, be sure the v-berth filler cushion(s) are installed securely before use.

C. Settee Cushions

Canted seating or settee cushions at the rear of the cabin allows for comfortable seating. Fill-in cushions extend the v-berth into a larger sleeping area. To extend the v-berth, lift the cushion edge, pull the flipper board up and stand on end. The port and starboard cushions will lay across the supports to form additional berth. See Figure K2.

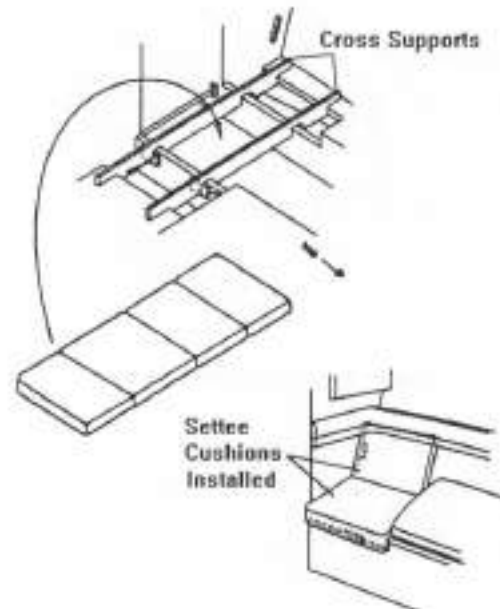

Figure K2: Settee Supports

K - 2 EXTERIOR SEATING

A. Bow Seating

Bow seating is provided on the Freedom, Horizon and Candia models. Certain cushions have hinges to allow for access to storage areas below.

Also, on the 240 Horizon a built-in lounge with armrest is provided in the bow area.

Filler cushions are optional. When installed, the filler cushions help form a berth across the bow area. These cushions are stored in the compartment beneath the dash and glove box.

B. Loungers

The loungers are built with lumbar supports and have inserts in both the seat and backrests. This is applicable to all models except Freedom. These inserts are installed with velcro and can be removed for easier cleaning of the cushions. The lounge has been designed so that each component is serviceable such as the inserts, headrest, and backrest wings. See Figure K3.

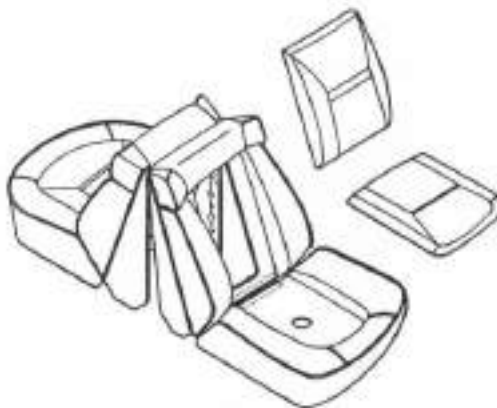

Figure K3: Lounger Assembly

The lounge will fold into a "lounger-type or reclining" position. A locking hinge on the aft end will allow for a headrest in the lounge position. Refer to Figures K7 & K8 at the end of this section for drawings on lounge operation.

In addition, the lounge is adjustable forward and back. To adjust, turn the handle upwards and push/pull the seat assembly. The total travel distance or adjustment is approximately six (6) inches.

C. Bucket Seats

The bucket seat or captain's chair also has lumbar supports (except Freedom) and will swivel. To swivel, locate the knob below the seat and loosen by turning counterclockwise. Then lift

on the chair before rotating. In addition, **DO NOT USE FORCE** to rotate the chair. To prevent upholstery damage, be sure the seat is not hitting the coaming pad or any other objects before adjusting. See Figure K4.

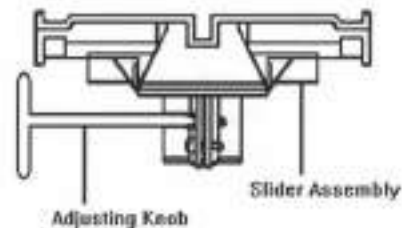

Figure K4: Bucket Seat Base

Both bucket seats are adjustable. To adjust, lift the lever below the seat and slide the seat forward or aft to the desired position. The seat will adjust a total of six (6) inches.

WARNING

DO NOT sit on the backrest portion of any cockpit seat. The helmsman could lose control of boat or passengers could be thrown from boat. Also, the seat may be damaged from improper use.

D. Stern (Jump) Seats

In a standard interior, the motor hood and two stern or jump seats are installed at the stern. The seats are supported by the motor hood base and ski rack (lower upholstered pads) in the bottom position.

To install the jump seats in the upper position:

1. Remove the seat.
2. Pull up on the support located inside the motor hood base to the upright position. Slide horizontally to the locked position. Be sure it is locked.
3. Locate the plastic support on the outboard side of the jump seat and slide this into the catch within the coaming pad. This will secure the cushion from being blown out of the boat.



- Drop the other side of the cushion into place. This will create a "couch" across the back.

CAUTION

To prevent personal injury, be sure the jump seats are secure and the supports are locked into position.

NOTICE

When traveling at highway speeds, be sure the stern seats are secure. Air currents (created within the interior when traveling) will lift the cushions up and out of the boat under certain conditions, especially when semi-trucks or other large vehicles pass by.

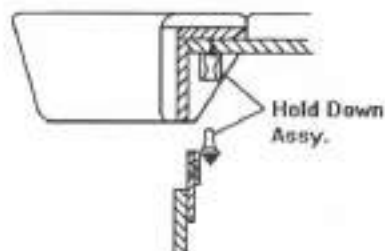

Figure K5: Hold-Down Assembly

The motor hood table is optional and is attached to the lid. To install: lift the table and spread the support arms to the sides. Refer to Figure K6.

E. Outboard and Fish & Ski Stern Seating

The outboard and Fish & Ski models have similar stern seating arrangements. On outboard models, the jump seats are supported by plastic (star board) cleats.

On Fish & Ski models, the carpeted base can be folded and removed from the boat. The thumb screw brackets will allow for easy detachment of the carpeted base. When removed, more usable space for fishing is created.

F. Top Storage

The top storage cushion at the stern of the boat allows for storage of the canvas top assembly. The top storage will be secured by a rubber ball and socket-type device. See Figure K5. It is important to lift the top storage at the strap, which is located next to the "Hold-Down Assembly" to allow for easier access.

G. Motor Hood with Table Option

The motor hood allows access directly to the engine compartment on standard models. The lid is hinged to the base. To gain access to the engine compartment, remove the stern seats before lifting on the motor hood. An aluminum pole is installed on the underside of the motor hood to support the lid in the "open" position.

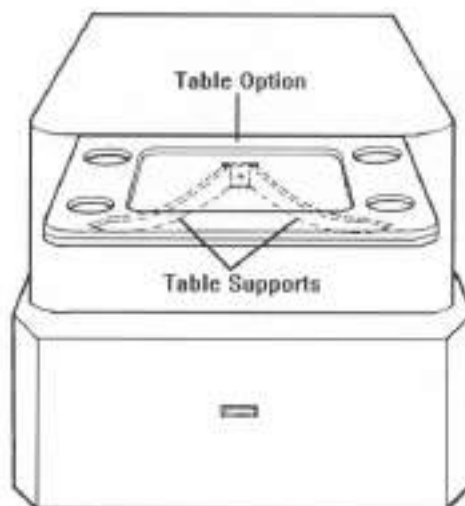

Figure K6 : Table Option

H. Wrap Around Seat (214 Candia Only)

On the 214 Candia, the aft couch assembly is standard with wrap around seating. Two bucket seats are standard. If the optional port lounger is installed, the stern seat will wrap to the starboard side only.

Optional fill-in cushions are available only with the standard interior and are supported by plastic cleats. The fill-in cushions form a large berth for sunbathing. Be sure to store the cushions properly when not in use; especially when traveling at highway speeds.



I. Sunsport Interior

The couch assembly is part of the optional Sunsport interior. On all sunsport models except Candia, the seat slides out and a filler cushion(s) can be installed to create additional berth. The fill-in cushion(s) will store in the engine compartment.

Sundecks with gas shocks or hydraulic supports are used to cover the engine. The sundeck can be used for sunbathing and is supported by bulkhead and other supports.

The sundeck is integrated with the headrest portion of the couch on most models. A hold-down assembly and strap are installed for opening and closing the sundeck.

The 214 Candia is standard with sundeck and couch assembly and is built very similar to the Horizon models. However, there are three separate sundecks. A hold-down assembly and strap are installed for each sundeck. An optional portable head with privacy curtain is installed under the starboard sundeck. Refer to Section G-5 Heads in this manual for additional information on this option.

J. Bow Fishing Chair

The bow fishing chair is an option only on the Fish & Ski models. This chair has a removable pedestal and will mount in either the bow or aft position.



WARNING

DO NOT sit on the backrest portion of any cockpit seat. The helmsman could lose control of the boat or passengers could be thrown from the boat. The seat could also be damaged if excessive force is applied.



WARNING

To avoid possibility of occupant being thrown from boat, NEVER ALLOW ANYONE TO OCCUPY AN ELEVATED FISHING CHAIR WHEN THE BOAT IS UNDERWAY AT MORE THAN TROLLING SPEED.

K - 3 INTERIOR UPHOLSTERY CARE

The fabric used in the cabin should be treated the same as upholstery in your home. Periodic vacuuming and shampooing will keep the upholstery clean and odor free. Spraying the upholstery with Lysol Spray Disinfectant will help retard mildew.

Cleaning Kit includes:

- Westley's Clear Magic
(to order, call 1-800-545-0982)
- Lendow Glass Cleaner
(to order, call 313-777-2236)
- Lift-off Spot Remover
(to order, call 216-881-4070)
- Clean, white towels
- Clothes shaver
- Air hose (if available)

To remove stains, please refer to the following list for recommended cleaners.

1. Basic Stains/Ink/Grease/Pencil/Dirt:

Westley's Clear Magic

2. Adhesives/Teak Oil/Gum/Tar:

Lift-Off Spot Remover

3. Water Stains:

- a. While fabric is still wet, use an air hose and nozzle to go over the wet area. This will force the stain into the back of the fabric.
- b. For water stains that have dried, spray Lendow Glass Cleaner over the stained area. Let the foam dissipate, then rub the area with a clean towel. Repeat.

4. Tough Stains/Set Water Stains:

- a. Always try the Lendow Glass Cleaner method first!



- b. Spray Westley's Clear Magic on the area, going two (2) inches around the stain or if possible, bring wetness to a break point, such as a bulkhead, etc. Spray water on the same area as directed on the bottle.
- c. Let set approximately five (5) minutes.
- d. Rub the area with a clean towel, rotating the towel as the stain is removed. As you rub, go a little beyond the wetness with the towel, flaring the edges.
- e. Allow to dry or blow complete area with air hose.
- f. Repeat if necessary or try the Lendow cleaner.
- g. After the stain is removed, use a clothes shaver to remove fuzzies.

K - 4 EXTERIOR UPHOLSTERY CARE

The vinyl material used on the exterior upholstery can be easily cleaned using mild detergent and water. Be sure to thoroughly rinse the seats after washing to remove all soap film. Periodic spraying of the seats with Lysol Spray Disinfectant will help retard mildew.

NOTICE

DO NOT apply vinyl protectants such as Armorall. The manufacturer does not recommend this product because it removes the oils present in vinyl that keeps vinyl soft.

Cleaning Kit includes:

- Ivory Dishwashing Liquid and water
- Clean, white towels
- Medium-soft brush
- Fantastik Spray Cleaner
- Denatured Alcohol
- 3M Citrus Cleaner

(to order, call 404-447-7132)

- Ammonia and hydrogen peroxide

To remove stains, follow the guidelines below.

1. Basic Stains/Grease/Pencil/Dirt:

Ivory Soap and water or Fantastik Spray Cleaner applied with a medium-soft brush.

2. Tough Stains/Adhesive/Teak Oil/Rust:

3M Citrus Cleaner; rinse with soap and water.

NOTICE

To prevent possible damage to the vinyl, rinse with soap and water after applying the 3M Citrus Cleaner.

3. Ink:

Denatured alcohol.

4. Mildew Stains:

To kill bacteria creating the mildew, vigorously brush the stained area with a 4-to-1 mixture of water and ammonia; rinse with water.

5. Tough Mildew Stains:

Apply a mixture of one (1) teaspoon ammonia, one-fourth (1/4) cup of hydrogen peroxide, and three-fourths (3/4) cup of distilled water; rinse with water.

NOTICE

ALWAYS CLEAN STAINS IMMEDIATELY! DO NOT use 409 Cleaner or Armorall on vinyl.

All cleaning methods must be followed by a thorough rinse with water.

Certain household cleaners, powdered abrasives, steel wool and industrial cleaners can cause damage and discoloration and are not recommended. Dry cleaning fluids and lacquer solvent should not be used as they will remove the



printed pattern and gloss. Waxes should be used with caution. May contain dyes or solvents that can permanently damage the protective coating.

Additional cleaning information is provided by the manufacturer and is included with this manual.

Four Winns offers a variety of optional weather covers for protection of the boat and associated equipment. Continued exposure can damage the upholstery and seating. The seating can become thoroughly saturated with water if not adequately protected. Refer to Section L on Weather Covers for more information.

NOTICE

The appearance and longevity of the exterior upholstery will be affected by water saturation. Protect these items appropriately.

K - 5 REPLACEMENT UPHOLSTERY

Should upholstery become severely soiled, torn, or in some manner damaged, replacement upholstery cushions and certain jackets are available. Larger upholstery items have separate component parts for easier serviceability.

Depending upon the year and model of the boat, most upholstery parts can be obtained through your Four Winns servicing dealer within a short period of time.

K - 6 CARPET CARE

A. Interior and Exterior Carpet

Four Winns Sport Boat models use a high quality grade carpeting in the cabin and cockpit. Vacuuming and occasional rug shampooing are recommended for extended life and appearance. It is 100% UV stabilized Olefin Polypropylene fiber.

The optional snap-in carpet for the cockpit with fiberglass liner is also made of 100% UV stabilized Olefin Polypropylene fiber. This is an exterior grade, high quality carpet with rubber-type backing.

NOTICE

DO NOT dry carpeting in an automatic dryer.

The snap-in carpet may be periodically washed with mild laundry soaps or shampooed, dried and reinstalled. Additional information is listed below.

B. Cleaning and Maintenance

The following information should be useful in helping you keep your carpet looking well maintained.

Carpet made with Olefin fiber possesses built-in stain and soil release for easy, less costly maintenance. Regular vacuuming and occasional shampooing help it stay attractive and serviceable.

C. Stain Removal

Even the most stubborn stains can be removed from Olefin fiber following the procedures outlined. A total of thirty-four stains were selected as being representative of spills commonly occurring on carpets. Stains were pressed into the carpet to simulate foot pressure following a spill. Stains were applied to a two-inch square section and allowed to penetrate. Removal was performed after two weeks. Carpets were tested for stain removal by an independent laboratory. Stain removal was effective for all 34 stains. Results are shown in the table.

Stain Removal Procedure

Regular Maintenance such as vacuuming, hosing or washing should be performed. Most stains and mildew are easily removed from carpet made with Olefin fiber using common household cleaners. Refer Table I. Olefin fiber is so resistant to chemical attack that Clorox bleach may be used to clean up any mildew that may result from excessive wetness.

Code for stain removal procedure:

"A" Apply hot water and detergent.

"B" Apply volatile dry solvent, work with bone spatula, blot.



"C" Flush by hot water extraction.

Recommended reagents:

- Carpet detergent such as "Mintex" (Hydro-master) or any carpet detergent suitable for hot water extraction.
- Volatile dry solvent such as "Carbona", "Energene", or "Picrin" (Street).
- Oily type paint remover such as nail polish remover, "Energene" or "Pyrotex" (Street).
- Neutral lubricant such as "Streetex Spray Spotter" (Street) or alternate treatment with detergent and "Energene".

Table I: Stain Removal

STAIN	REMOVAL PROCEDURE
Automotive grease	A
Automotive oil (new or used)	A
Bacon grease	A
Berry stain	A
Blood	A
Butter	A
Catsup or Mustard	A
Chewing gum	A, B (repeat)
Chlorine bleach (5%)	A
Chocolate (melted)	A
Clay (red)	A
Coffee or Tea	A
Cola	A
Crayon	A, B, C
Egg	A
Feces	A
French Dressing	A
Furniture polish	A
Grape juice	A
Gravy	A
Ink (permanent black)	A, B, C
Ink (Scripto, ballpoint)	A, B, C
Iron rust	A
Lipstick	A, B
Mayonnaise	A
Milk	A
Shaving Cream or Lotion	A
Urine	A
Vomit	A
Wine	A

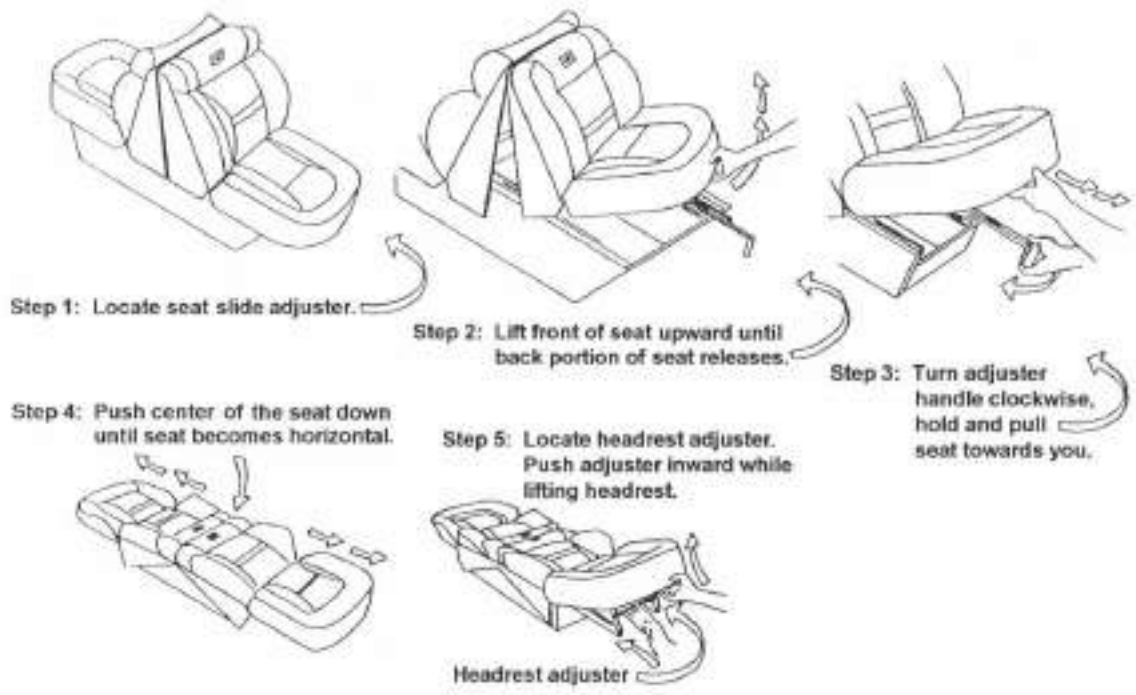

Figure K6: Steps to change lounge to the "down" position.

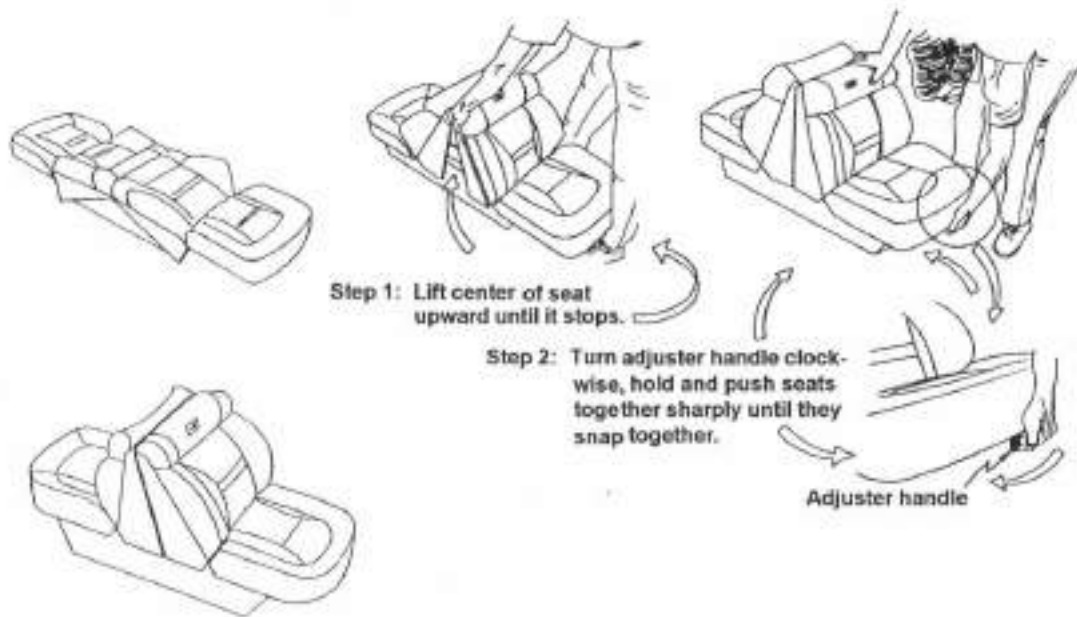

Figure K7: Steps to change lounge to the "up" position.



WEATHER COVERS

L - 1 GENERAL INFORMATION

Weather covers for the cockpit areas are available on all Four Winns models. Convertible and bimini tops, side and aft curtains, campers, and cockpit covers are available on most models. Four Winns covers are designed and intended to provide protection of the cockpit seating areas.

Four Winns utilizes acrylic-type material for all its covers. All Sport Boat canvas except mooring covers consist of 100% acrylic Sunbrella material and is color matched to the boat. The mooring covers are made of 10 ounce acrylic (not Sunbrella) and come in gray only.



WARNING

Never use any form of open flame cooking device while under, in any area fully enclosed, or near any acrylic weather cover. This material is flammable.

During the manufacture of the weather covers, the smallest possible needle and highest quality UV stabilized, bonded polyester thread is used in the stitching.

The weather cover is water repellent but not water proof. During a hard rain, you may notice a light mist permeating through a weather cover. This is normal. If the seams leak, they can be sprayed with Scotchguard or similar water repellent or a seam sealing compound can be applied. Keep objects from contacting the inside of the cover. Leakage may occur at point of contact.

Weather covers must be installed taut or will be damaged by accumulation of rain water.

NOTICE

Periodically check weather covers for accumulation of water. Damage to the bow assemblies may otherwise result. Make sure cover is taut to avoid puddling of water.

After use, the top canvas should be rolled up into the boot (if supplied) and secured.

NOTICE

NEVER fold or store a wet weather cover. This can lead to mildew or shrinkage. Roll rather than fold the enclosure curtains. Sharp folds increase the chance of cracking the clear vinyl.

NOTICE

DO NOT use the weather covers during outdoor winter storage. The weight of the snow or heavy rain can cause severe damage to the material or top structure. Refer to L-3 Winter Storage in this manual for more information.

When snapping covers to the boat, apply direct downward pressure on the snap. When unsnapping, rotate the snap and cover upward at each snap location.

NOTICE

Remove snaps one at a time to prevent damage. DO NOT rip off or pull the weather cover as a whole; acrylic material may tear at snaps.

A. Convertible Top (Suntop)

The convertible top covers the cockpit area and is stored on most models in the rear engine compartment, under the top storage or sundeck.

To install:

1. Attach the main bow to the windshield mount and unroll the canvas.
2. Snap the forward edge of the top to the windshield. Windshield snaps will slide to adjust to the canvas.

NOTICE

The center snap should be centered on the windshield, then adjust all other windshield snaps to align to canvas snaps.

3. Adjust the secondary bow to support the canvas and attach the nylon strap to the

strap eye located on the deck. The strap can be adjusted for tautness.

NOTICE

On most models, couplers on the bow extensions allow for vertical adjustment. Horizontal adjustments can be made with the buckle located on the nylon strap and by sliding the secondary bow(s) up or down along the main bow.

B. Side Curtains

The side curtains are used to enclose the area between the windshield wings and canvas. Each curtain will zip to the underside of the suntop and snap to the windshield wings. Windshield snaps will slide to adjust to the curtain.

NOTICE

DO NOT FOLD THE SIDE CURTAINS! Damage may result. Always roll the side curtains up to prevent damage to the isinglass.

C. Aft Curtain

The aft curtain encloses the remaining cockpit area when the suntop is installed. The aft curtain is part of the full canvas option (which includes suntop and side curtains). Refer to Figure L1.

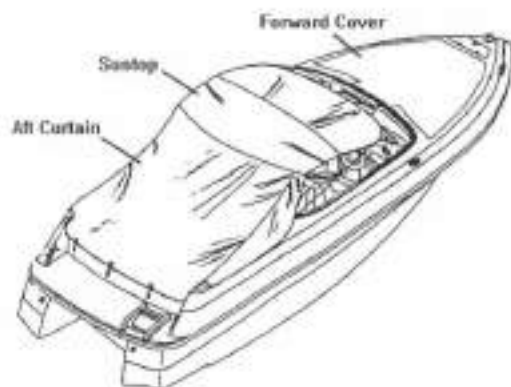

Figure L1: Full Canvas

To install:

1. Attach the aft curtain to the zipper provided on the rear portion of the suntop.

2. Secure the rear corners.
 - a. If the canvas has snaps along the aft edge, secure the corners.
 - b. If the canvas has shock cords along the aft edge, attach to knobs as shown in Figure L2.

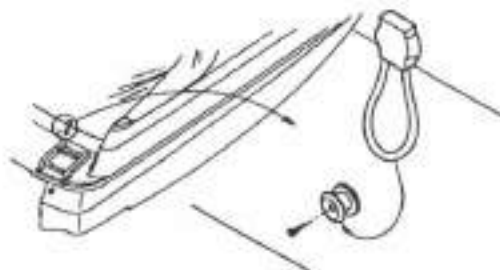

Figure L2: Shock Cords

3. Finish snapping canvas to deck.

When storing the aft curtain, fold canvas in a manner which will keep the isinglass from creasing.

D. Forward Cover

The forward cover is available on Freedom and Horizon models only. It is installed over the bow seating area and is snapped to the deck. An adjustable pole is provided to adjust the canvas for tautness. Refer to Figure L1.

E. Bimini Top (Horizon & Sundowner)

The bimini top is optional on the Horizon and Sundowner models. This is a free-standing top and is supported only by the bow assembly. Refer to Figure L3.

To install:

1. Attach the main bow to the windshield mount. The secondary bows should be loose to allow for adjustment.
2. Attach the nylon straps to the strap eyes located on the deck. The forward strap eyes on the Horizon and Sundowner models will be located on the windshield.

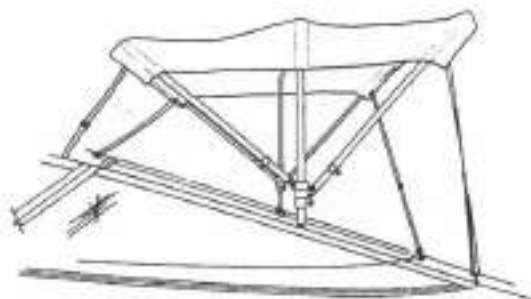

Figure L3: Horizon/Sundowner Bimini Top

3. Adjust the bows and straps for tautness.

The bimini top can be stored in the rear engine compartment under the top storage or sundeck.

When storing below the top storage, it is important that the canvas is rolled up properly onto the bows. Open the lid, then:

1. Position one bow (at an angle) and insert into the hole provided in the corner of the deck.
2. Rotate the other bow down into the hole on the opposite side.
3. Check placement of bows inside engine compartment. Be sure cables and wiring are not affected.

NOTICE

DO NOT try to insert both bows into the holes at the same time. Bows must be inserted one at a time and at an angle.

To prevent damage to the upholstery and to make the storage process easier, use two people when storing the bimini top.

F. Bimini Camper

The camper canvas is an option which encloses the cockpit area and allows for overhead space. Covers roll up to expose the window screens. It is available only with the bimini top. Refer to Figure L4 and Table 1.

To install:

1. Install bimini and side curtains as previously instructed above.

2. Attach camper bows to deck hinge. Unroll canvas and attach forward edge of canvas to bimini zipper.
3. Adjust bows and attach strap to strap eye.
4. Attach shock cords to deck. Fine tune the installation by adjusting the bows and nylon straps.

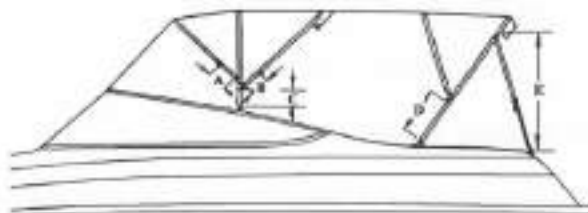

Figure L4: Camper Canvas Option

MODEL	BOW EXTENSION & HEIGHTS (INCHES)				
	A	B	C	D	E
190 H	11.0	11.0	10.5	16.0	31.5
200 H	11.5	11.5	10.0	15.0	30.25
220 H	11.5	11.5	10.0	18.25	N/A
240 H	8.0	9.5	7.5	17.75	N/A
195 S	11.0	11.0	10.0	14.0	31.50
205 S	11.5	11.5	10.0	15.0	30.25
225 S	11.5	11.5	10.0	18.25	N/A
245 S	8.0	9.5	7.5	17.75	N/A

Table 1: Canvas Bow Adjustments By Model

G. Candia Bimini Top

On the 214 Candia, the top canvas is free-standing and covers most of the cockpit area. It is very similar to a bimini top but will store on the deck when not in use. Braces are included to support the bow assembly.

To install:

1. Remove cover and lift canvas assembly to upright position. Insert primary bows into



deck hinge and secure with quick release pin.

2. Insert brace rod into deck hinge. Secure with quick release pin.
3. Unroll canvas. Spread out primary and secondary bows.
4. Attach forward nylon straps to strap eyes.
5. Adjust the bows and straps for tautness.

H. Cockpit Cover

The cockpit cover is used to cover the complete cockpit area and is intended as a short term storage cover.

To install:

1. Snap the forward edge of the cockpit cover to the walk-through on the windshield. Windshield snaps will slide to adjust to the canvas.
2. Secure the rear corners.
 - a. If the canvas has snaps along the aft edge, secure the corners.
 - b. If the canvas has shock cords along the aft edge, attach to knobs as shown in Figure L2.
3. Snap the cockpit cover sides and rear (if applicable) to the deck.

An adjustable pole is provided to adjust the canvas for tautness.

I. Mooring Cover

Mooring covers are intended for longer term storage and spread over the entire boat. If used in areas with snow accumulation, be sure to support the canvas adequately and inspect frequently for snow loads or damage will occur. Refer to L-3 Winter Storage for additional information.

To install:

1. Spread mooring cover over entire boat.
2. Install adjustable poles in bow area (if applicable) and in the rear cockpit. Be sure the canvas is taut and no pockets exist.
3. Tie off at the transom.
4. Nylon loops are provided for attaching rope or bungee cords to the trailer or from side to side (under the boat).

L - 2 TRAILERING

High winds encountered during trailering your boat can severely damage most weather covers. If an extended trip at highway speeds is planned, the top and other weather covers should be in the down position or removed entirely. This will prevent damage and loss.

L - 3 WINTER STORAGE

The boat must be properly protected during winter dry dock storage. A winter storage cover is advisable. Many marine dealers offer shrinkwrap enclosures for outdoor storage. See a Four Winns dealer for information on the availability of winter storage covers or other alternatives for storage.

When storing outdoors, make sure the supporting framework keeps the weight of the snow and rain from accumulating on the storage cover. Proper ventilation must also be provided or dry rot and mildew will occur. See Section O General Maintenance for additional winter storage information.

L - 4 MAINTENANCE

Moisture, dirt, chemicals from industrial fallout, heat, ultraviolet rays and in some cases, salt water are factors which affect the longevity of acrylic covers.

1. Moisture can cause shrinkage and mildew. Allow the cover to dry thoroughly before



disassembling tops. Keep it clean and well ventilated to prevent mildew. Spraying the weather cover with Lysol Disinfectant or similar product will help prevent mildew.

2. Dirt creates a starting point for mildew when moisture is present. Clean the top with a sponge or soft scrub brush and mild detergent when the cover is installed. Make sure cover is taut to help prevent shrinkage.
3. Chemicals cause decay if allowed to accumulate for long periods of time. Keep the cover clean to prevent decay.
4. Heat can cause cracks in vinyl components and stiffening of fabric when enclosed in plastic or polyethylene. DO NOT store the weather cover in polyethylene under direct sunlight or high temperature situations.
5. Ultraviolet degradation may occur under prolonged exposure to direct sunlight. Store the top in the boat when not in use.
6. Salt water can corrode brass, aluminum, or stainless steel fittings and fasteners. Keep fittings clean, lubricated, and waxed to prevent corrosion.

Clear vinyl curtains and windows demand extra care to prevent scratching. DO NOT use cloth or chamois skin. Dirt or grit in the cloth will scratch the vinyl window. Hose clean water onto vinyl to rinse off salt, dirt, or grime.

NOTICE

DO NOT use hot water. DO NOT dry in an automatic dryer. DO NOT dry clean or steam press.

Leakage after cleaning may be the result of insufficient rinsing. Re-rinse. If leakage continues, apply a coat of silicone air drying water repellent, such as Scotchguard.

See your Four Winns dealer for additional information on weather covers.

L - 5 CARBON MONOXIDE

When the boat is underway, a natural vacuum may exist with the right wind and sea conditions to draw the exhaust gases (which includes carbon monoxide) into the boat. When the camper or side curtains are installed, this compounds the possibility of this occurring. Carbon monoxide may also be present when mooring or near sea walls. For more information, refer to Section H-4 Carbon Monoxide in this manual.

The carbon monoxide in exhaust fumes can be hazardous. It is important for you and your passengers to be aware of the potential safety hazard created by exhaust fumes. Familiarize yourself with the symptoms of individuals overcome by carbon monoxide, and most importantly, ways you can protect yourself and your guests.

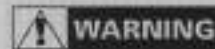

WARNING

DO NOT inhale exhaust fumes! Exhaust contains carbon monoxide which is colorless and odorless. Carbon monoxide is a dangerous gas that is potentially lethal.



FIBERGLASS AND HULL INFORMATION

M - 1 HULL DESIGN INFORMATION

Four Winns boats are designed using the sound engineering and mathematical principles of hydrostatics, hydrodynamics, structure, and strength of materials. The materials utilized provide optimum strength at the lightest possible weight. The exact fiberglass laminate schedule and construction techniques of each part is determined in accordance with the strength and rigidity required.

All Four Winns include our patented **Stable-Vee** hull design. Pods on either side of the outdrive extend the running surface beyond the transom. These pods, plus the unique distribution of dead-rise from transom to bow, allows Four Winns to place more hull in the water than deep-vee designs of similar length and beam. This results in better boat handling whether on plane, during turns, or at rest.

M - 2 FIBERGLASS CONSTRUCTION

The fiberglass components of Four Winns boats are of the finest quality materials, workmanship and construction techniques available. This ensures the structural integrity to provide years of boating enjoyment with minimal maintenance.

The construction of a Four Winns hull begins with the application of gel coat to the mold. The gel coat is approximately 20 mils thick. A coat of resin and chopped fiberglass is then sprayed into the hull and carefully hand rolled until it is securely affixed to the gel coat.

A number of fiberglass layers and woven roving are applied to the above laminate. Each layer is hand laid and hand rolled. The keel and chine areas have fiberglass woven roving overlapped in these areas to provide additional strength. Some models utilize encapsulated end-grain balsa core or coremat laminates to achieve additional rigidity. Others utilize additional laminations of woven roving to maintain strength and rigidity.

The hull support stringers are located using special tools, and are fiberglassed into place. This ensures a strong, rigid hull, permanently formed into a solid assembly, free of distortions.

Fiberglass cockpit liners, seat bases, v-berths, and bow pulpits are constructed similar to the hull. Balsa core or coremat laminations are utilized when necessary.

In addition to a thorough visual inspection of each fiberglass component, samples are measured using special equipment, for fiberglass reinforcement to resin ratio, laminate configuration, weight and thickness. By these procedures Four Winns ensures proper composition.

M - 3 EQUIPMENT INSTALLATION

Many boats are used for specific purposes or under conditions which require the addition of special equipment to the hull, deck or cabin areas. Special care must be taken during the installation of any equipment to a fiberglass component. A polysulfide or butyl based sealant should be used to seal installations below the water line. Silicone "marine" seal or similar bedding compound should be used elsewhere.

NOTICE

DO NOT install any item onto or through the hull without adequately sealing the hull area penetrated by the installed item or related fasteners. Improper installations could cause leakage or allow water absorption and thus cause serious hull damage.

Always pre-drill fastening holes with a proper size bit. Pre-drilling will help prevent the fiberglass from splintering and thus causing unsightly damage. Also, counter sink holes to prevent the gel coat from chipping.

Any equipment which will be subjected to cyclic loading or significant force should be through-bolted to a fiberglass component. A butt block or



backing plate should be used to strengthen any area onto which an item will be mounted.

M - 4 FIBERGLASS CARE & MAINTENANCE

Fiberglass is affected by weathering processes and requires maintenance on a periodic basis to help maintain the beauty and shine. The effects upon the gel coat will be dependent upon boating conditions, storage, type of use, and the care given to the boat during the boating season.

Four Winns utilizes fade-fighting Armorcoat™ gel coat in the exterior finish. It is specially formulated to resist fading and yellowing, and retain more of its original gloss than better grade gel coats. However, it is still important to maintain the gel coat to protect the finish.

A. General Maintenance

For fresh water use, the boat should be washed once or twice a month. When using in a salt water environment, considerable more care will be necessary. Be careful when selecting a cleaning agent. Hand dishwashing detergents are usually gentle and are recommended for cleaning gel coat. Cleaning products such as Ivory or Dawn hand dishwashing liquid can be safely used. Always read the label before using any product.

NOTICE

DO NOT use acetone, paint thinner, solvents, or strong alkaline based detergents, nor cleaners with a "gritty" and abrasive texture. Avoid products which contain sodium phosphate. Common examples of these types of household cleaning agents are: Tide, Oxydol, Janitor-in-a-Drum, Fantastic, Clorox, etc. Always read the label before using an agent.

There are several products available which are specifically designed to clean fiberglass exterior finishes. Many companies like Johnson & Johnson, Turtle Wax, etc. manufacture cleaning fluids mild enough to clean without stripping the wax.

NOTICE

Treading on a soiled fiberglass surface can severely scratch and mar the finish. Keep the fiberglass as clean as possible.

When cleaning non-skid areas, DO NOT attempt to use a wire brush or sandpaper because this will remove the non-skid gel.

Apply wax once a month to maintain gel coat lustre. Read the label before using any product. Make sure product is applicable to fiberglass. Refer to the brochure on gel coat care in your owner's packet. Also, consult a Four Winns dealer for his recommendations.



CAUTION

Waxing decks, cockpit floors or other areas on which one walks is not recommended. Waxing will produce a very slippery surface, especially when wet. Wax may also build-up in the non-skid surfaces. Be sure all persons wear deck shoes while aboard the boat. Footing will be improved and feet will be protected from accidental cuts and bruises.

A darkening or discoloration of the non-skid surfaces can sometimes occur as a result of wax buildup. Exposure to the sun and elements can turn the wax darker, or occasionally can cause it to become flaky or powdery. To remove, use fine rubbing compound and a low RPM buffer (1200 to 2000 RPM). Apply light pressure and keep the buffer moving at all times to prevent heat build up. Read the directions before using any equipment.

B. Weathering Effects on Gel Coat

Weathering occurs from direct sunlight, water, chemicals, and dust. Some of the terms below describe the changes that can occur to the gel coat surface.

Chalking is a result of the gel coat's top surface being broken down into an extremely fine powder. When this happens, the color whitens. The chalk is present on the surface only.

Fading is the uniform change in color. This happens when the actual pigments have changed



color, especially from excessive chalking, or when the gel coat has either been stained or bleached by something.

Yellowing is gel coat which has a yellow cast and streaking usually deals with a stain or contact with another surface.

Gloss refers to the shine of the surface. This can change from sanding action, chalk, residues, or exposure.

Blistering refers to a condition in which the unprotected gel coat surface below the waterline has absorbed water and formed bubbles. See Section M-5 for additional information.

Follow the instructions below for boats that have weathered and chalked.

1. Wash.
2. Wax. If this does not work, then use a fine rubbing compound. If this does not work use 400 or 600 wet or dry sandpaper, followed by fine rubbing compound and wax.

When using wax or fine rubbing compounds, make sure to read the label and follow the directions. Some helpful tips are listed below.

1. Avoid working in direct sunlight. This dries out the wax or compound, and can stain the surface.
2. Use clean pads or cloths to apply a thin coating of wax or rubbing compound to a small area such as three feet by three feet. Remove any excess, and then rub the area with a buffing pad, or power buffer. Apply pressure only as necessary to restore the surface finish. Applying too much pressure or buffing in one place too long can permanently damage the surface.
3. After applying compound, always follow with waxing.

NOTICE

If using a power buffer, use a low RPM buffer with light pressure. Keep the pad wet and the buffer moving at all times to prevent heat build up.

NOTICE

When sanding, DO NOT use a power or belt sander to prevent gouges, uneven areas, or other damage. For best results, block sand the gel coat.

C. Stains

Stains can appear anywhere on the exterior of the boat and may be a result of contact with tar, plant sap, leaves, rust from metal fittings, and other materials. Surface stains may be removed with hand dishwashing soap, mild cleansers, or some household detergents. DO NOT use chlorine or ammonia products. These products can affect the color of gel coat. Commercial car washes use strong cleaners and should be avoided.

To remove stains, refer to the procedures below.

1. Wash area with hand dishwashing soap.
2. Begin with a small area such as three feet by three feet and apply a mild cleanser.
3. Rinse with clean water.
4. Follow with compound and waxing as outlined in procedure above.

If the stain is not removed by the hand dishwashing soap or mild cleanser, then the next procedure is to use either denatured or rubbing alcohol. If this does not work, consult your Four Winns dealer for professional assistance.

NOTICE

DO NOT use acetone, ketone, or other solvents to remove stains. These chemicals are flammable and may damage the gel coat.

M - 5 FIBERGLASS REPAIRS

Fiberglass is one of the most durable, strong, and forgiving construction materials afloat. It is resilient and normal repairs can be made without affecting the strength or structural integrity of the boat.



WARNING

Striking docks, other boats, or submerged objects could create a very hazardous situation or severely damage the fiberglass. In the event an object is struck below or near the waterline, proceed directly and cautiously to the nearest service facility and remove the boat from the water. Closely inspect the hull for damage. If the outer fiberglass laminate was penetrated, repairs must be made prior to re-launch.

Occasionally, blisters, crazing, scratches, or damage to the fiberglass can occur. Repairs may be necessary to correct the problem.

A. Scratches

Scratches occur during normal use. Below is a step by step procedure to repair scratches.

1. Clean area with soap and water.
2. Apply a fine rubbing compound and buff.
3. Wax.

If this does not work, clean the area and sand lightly with 400 to 600 wet or dry sandpaper and follow with rubbing compound and wax.

B. Gouges & Cracks

Stress cracks and crazing are the appearance of hairline cracks in the gel coat surface. When present, these problems usually occur in the gel coat finish or the outer "skin" coat fiberglass laminate. The appearance of these cracks do not pose a threat to the structural integrity of the boat. In most cases, they are cosmetic and can be treated.

Cosmetic surface damage can be repaired as follows:

1. Sand the surrounding area with medium or fine grit sandpaper. Clean all marine growth, dirt, anti-fouling paint, etc. from the immediate area. DO NOT excessively scratch or gouge the surrounding area.

2. Use a hard, pointed tool to open the gel crack. Take care not to damage the surrounding gel coat.
3. Sand the crack or gouge so the edges are smooth and will allow proper "feathering" of the area.
4. Clean the area thoroughly. Make sure the area is dry before proceeding.

NOTICE

Be sure the structure and the ambient temperature are above 60 degrees F (15 degrees C) and the relative humidity below 70% immediately before, during, and after the repair.

5. If the nick or gouge is deep and penetrates through the gel coat, fill the area with fiberglass patching paste. Follow the directions on the can when mixing the paste with the catalyst.
6. After the gouge is filled and has dried, sand the patched area. Begin by using medium-fine grade sandpaper. Progressively use finer grade sandpaper until the surface is very smooth. If necessary, add filler and then sand the surface again.
7. Apply two or three light coats of matching fiberglass gel coat to the repaired area. Enough gel coat should be used so that the entire area is covered.

The gel coat must be catalyzed using up to 2% MEK Peroxide which can be purchased at a supplier handling fiberglass reinforced products. Contact your Four Winns dealer for assistance.

8. After ample drying time, sand the area using very fine wet/dry sandpaper. If the appearance of the area is still not satisfactory, repeat steps 2 through 4 as necessary.
9. If above the waterline, polish the area using a fiberglass rubbing compound and then wax. If the repaired area is below the waterline, the area should be primed and painted in accordance with the anti-fouling paint manufacturer's instructions.



Gel coat, like paint, will change colors with time and exposure to sunlight (ultraviolet). For this reason, "matching" gel coat obtained from Four Winns may not match the gel color of a boat that has been exposed. However, this is the closest match commercially available. A fiberglass technician can tint the gel to be used in the repair to provide a closer color match.

More severe fiberglass damage, especially when structural, requires the expertise of an experienced fiberglass repair technician. See your Four Winns dealer for assistance.

NOTICE

Improper repair techniques can lead to further fiberglass component damage.

C. Osmotic Blistering

Osmotic blistering or "boat pox" is an unfortunate but not uncommon occurrence in fiberglass boats. Fiberglass is water retardant, not water-proof. When a boat is left in the water for a period of time, the fiberglass will absorb water. It is a natural process that can not be eliminated in production methods or material selection and usage. However, there are ways to control and possibly prevent blisters (see Section M-6). If you do encounter blisters, be assured that the blisters are merely cosmetic. They do not indicate a defect in the boat structure or lamination. Four Winns, along with most boat manufacturers, regard gel blisters as a standard maintenance item.

The repair procedure for gel coat blisters is similar to the procedures outlined in the previous section on cracks and gouges. There is an exception however, in that the hull must dry out for several days or possibly weeks before repairs can proceed.

To determine if the hull has dried sufficiently, tape one square foot of household plastic wrap securely to the hull bottom. Make sure all edges are sealed and let it stand for twenty-four hours. If condensation has accumulated under the plastic, the hull is still "wet" and must be allowed to dry longer before repairing.

When the repair is completed, an application of an epoxy barrier coat should be considered. This

will help prevent the possibility of recurrence of blisters. Your Four Winns dealer or local ship store will have information on barrier coat products.

M - 6 ANTI-FOULING PAINT

Four Winns recommends anti-fouling or bottom paint for boats which will be kept in the water for extended periods of time. Anti-fouling paint reacts with water to retard the growth of algae, barnacles and other marine growth on the hull. In addition to marine growth, it offers protection against excessive water pollution.

Anti-fouling paint begins reaction upon contact with water. After a season's use or sooner under certain conditions, the anti-fouling paint may appear to be dissolving. This is due to the paint's chemical emission that in turn retards marine growth. When this occurs, refinishing is in order.

Four Winns recommends re-application of the anti-fouling paint seasonally. The effectiveness of the paint will be drastically reduced if used longer. Though Four Winns has found the anti-fouling paints used to provide good marine growth protection in most water, other paints may be more effective in certain water conditions. See a Four Winns dealer for recommendations on antifouling paint use in your area.

NOTICE

During surface preparation, the hull should be sanded only enough to remove any foreign matter, and loose paint. DO NOT sand deeply into the gel coat, fiberglass cosmetic problems could later result. After sanding, the surface should be wiped with a rag treated with a cleaner recommended by the anti-fouling paint manufacturer. The surface must be clean and slightly rough to ensure paint adhesion.

Prior to application of the anti-fouling paint, the boat owner may consider coating the hull bottom with an epoxy coating. Four Winns recommends this procedure as a preventive and effective means of controlling osmotic blistering. Most major anti-fouling paint manufacturers also



supply a line of epoxy undercoatings. Consult your Four Winns dealer or local ship store for their recommendations.

M - 7 HULL SUPPORT

Proper support of the hull while it is out of the water is imperative. Due to the design complexities, Four Winns does not recommend trailers or storage cradles be home-made. The boat is a valuable piece of equipment. DO NOT risk permanent damage to the hull structure in an attempt to save the cost of an adequate support. Improper support can lead to serious and permanent hull deformation.

NOTICE

When attempting to raise the hull, never allow one end of the boat to rise first, while letting the opposite rest momentarily on the outdrives or underwater gear. Serious damage to these components could result. DO NOT place lifting straps on underwater gear. Be sure the strap is against the hull surface only.

A trailer, or storage cradle designed for a larger or smaller boat will not provide proper support for the hull. This could lead to hull deformation and thus serious performance deficiencies.

Four Winns trailers are available for all Vista models. Refer to Section P Trailers for additional information.



WOODWORK AND COMPOSITES

N - 1 TEAK

Solid teakwood is being used on the platforms as an insert on most models. This wood gives a rich warm appearance with minimal maintenance. Under normal conditions, teak is resistant to rot and will not structurally deteriorate. Exposure to the sun and elements will only cause the wood to turn grayish white. Teak can be restored to its original appearance with minimal care using teak care products that are commercially available.

For a natural teakwood appearance, Wattco Teakwood Oil or Prelude Marine Oil Finish is recommended. When proper application procedures are followed, these dressings can provide a long lasting, protective coating. Many other fine teakwood finishing materials are available. Check with a Four Winns dealer for recommendations on materials commonly used in the immediate area.

To maintain teak, follow directions below.

1. Extended exposure will cause the grain of the wood to rise. The teak will feel and appear rough. Should this occur, lightly sand teak using a hand sanding block and medium grit sandpaper. Sand the wood only enough to smooth the surface.
2. Liberally apply a teakwood dressing. This will replenish the lost teak oil. Repeat the application in a few days.
3. Periodically apply teakwood dressing to keep the wood dark and rich in appearance. DO NOT varnish or paint the teak. The oil emitted by the teakwood will cause the varnish or paint to peel.

Once the teak becomes excessively gray (weathered) more complex cleaning or bleaching is necessary to restore it. Many teak restoration products are available from any Four Winns dealer. Consult your Four Winns dealer for his recommendations.

N - 2 HIGH-PRESSURE LAMINATE CARE

Table tops, hanging locker door and cabinet fronts consist of a high pressure laminate, "formica" like material. The formica has a "matte texture" finish and can be cleaned with hand dishwashing soap and water or other cleaning solutions such as Fantastic. Always read the label before using any product.

NOTICE

DO NOT use abrasive cleaners or solvents on formica. DO NOT use Soft-Scrub soap or similar cleaning products; they will scratch the surface and remove the shine.

N - 3 ASH

Four Winns utilizes ash trim for interior trim on Sundowner models. The wood is prepared with a light stain followed by a polyurethane finish. To clean, a damp cloth will usually suffice. Care should be similar for ash as it is for fine, household furniture.

N - 4 STAR BOARD

Star board is a high density polyethylene (plastic) and is very durable and fade resistant. Star board requires little maintenance, and is being used in place of wood in many areas of the boat. It is currently being used for trim, step pads, hand rails, and seat supports.

To clean star board, use a solvent-free, non-abrasive cleaner such as hand dishwashing soap or Fantastic. Read the label before using any cleaning product.

NOTICE

Star board will stain when exposed to certain oils or chemicals. Always wipe up any spills immediately.



N - 5 MAHOGANY

Mahogany is used in the SL option package offered on all Sport Boat models. The dash panel, switch panel, glove box door (except Freedom) and steering wheel are manufactured with finished mahogany.

The mahogany is prepared with a light stain followed by a polyurethane finish. To clean, a damp cloth will usually suffice. Care should be similar for mahogany as it is for fine, household furniture.



GENERAL MAINTENANCE

O - 1 WINTERIZATION

A. Prior to Lifting for Winter Lay-up

1. Pump out the head (dockside discharge), and be sure the holding tank is empty. Flush the portable head's tank with soap, water and a deodorizer (e.g., Lysol Liquid). Add more water if necessary. Have the cleaning solution pumped out.
2. Have the fuel tank either completely full or completely empty. See the "Engine Owner's Manual" for recommendations. Also, check with the dry dock operators for recommendations. If winter storing with a full fuel tank, gasoline winterizer such as OMC 2+4™ Fuel Conditioner will reduce varnishing, condensation, etc.

NOTICE

If the fuel has been treated with winterizer, run the engine for ten minutes to make sure the treated fuel is present in all lines and parts of the engine.

3. Drain water from the fresh water system (if applicable).
4. Winterize the engine and drive systems as recommended in the "Engine Owner's Manual". Portions of this winterization procedure may require that the boat be lifted.
5. If the boat is to be lifted or taken off the trailer, see Section M-7 Hull Support in this manual for additional details.

B. After Lifting

1. Remove the drain plug.
2. Thoroughly wash the fiberglass exterior, especially the hull bottom. Remove as much marine growth as possible.
3. Lower boat onto cradle properly or place boat on trailer. Be sure boat is adequately supported. The boat should be raised slightly under the forward supports or trailer tongue to improve drainage to the transom drain.
4. Be sure all the water is completely drained from the fresh water system. Disconnect all hoses, check valves, etc. and blow all the water from the system using very low air pressure. The use of non-toxic, fresh water system anti-freeze is recommended as an alternative to disassembling the water system. Refer to Section G-7 System Maintenance in this manual for information on winterizing the water system.
5. Winterize the head as recommended by the head manufacturer. Also, refer to Section G-7 System Maintenance for additional information.
6. Ensure that all water is removed from the bilge pump and bilge pump lines. Dry the hull bilge, and self-bailing cockpit drain troughs. Water freezing in these areas could cause damage. See Section H-3 Hull Drainage Systems.
7. Remove the battery and store it in a cool place. Clean the battery using clear, clean water. Be sure the battery has sufficient water and clean terminals. Keep the battery charged throughout the storage period. Do not store the battery on a concrete floor or other damp or conductive surface.
8. Drain the butane out of the stove (if applicable) and store in a cool, dry place away from heat or spark.
9. Clean the boat interior thoroughly. Vacuum carpets, and dry clean drapes and upholstery jackets as necessary.



10. Scrub the hull bottom and wash exterior fiberglass components, wax lightly.
11. Clean exterior upholstery with mild soap and water, rinse, and dry thoroughly.
12. Remove all oxidation from exterior hardware and apply a light film of moisture - displacing lubricant.

C. Prior to Winter Storage

1. Remove as many cushions as possible. Remove storage lids or hatches. Open as many locker doors, as possible. Open the ice box or refrigerator door. Leave these areas open to improve ventilation.
2. Spray the weather covers and the boat upholstery with Lysol Spray Disinfectant. Enclosed areas such as the refrigerator, head, storage locker areas, etc. should also be sprayed with Lysol disinfectant.
3. Place small dishes of rodent poison such as D-Con in a number of areas around the boat. Be sure dishes are placed near the head and the engines, as rodents will destroy water intake and discharge hoses.
4. If the boat will be in outside storage, properly support a storage cover and secure it over the boat. DO NOT secure the cover tightly to the boat. This does not allow adequate ventilation and can lead to dry rot. DO NOT store the boat in a damp storage enclosure. Excessive dampness can cause electrical problems, corrosion, and dry rot.
5. DO NOT use the bimini top or convertible top as a winter storage cover. The life of these covers may be significantly shortened if exposed to harsh weather elements for long periods.



WARNING

Placing an electric or fuel burning heating unit in the bilge of the boat during cold weather could cause fire or explosion and is not recommended.

NOTICE

Boats stored outside in areas with heavy snow accumulation are more susceptible to damage, and should be inspected regularly during the winter months.

6. Engine should be winterized according to the engine manufacturers manual.

O - 2 ENGINE FLUSH OUT

The optional engine flush out should be used to clean the engine of unwanted salt, mud, sludge, etc. which may have accumulated in the engine cooling system. Before winterizing the engine, flush out the system for at least five minutes.



CAUTION

Make sure that no section of flush hoses are in contact with moving or hot engine parts or abrasive surfaces such as screw threads, sharp edges, etc., which could damage the hoses. Damage to the hoses could cause leaks and possible flooding of the engine compartment. Periodically check hoses for abrasions.

NOTICE

The flush out kit should only be used with the boat in the water and the engine OFF.

To flush out the engine, follow the instructions below.

1. Do not run engine during flushing procedure.
2. Remove cap from coupling and attach swivel connector.
3. Attach water supply hose to swivel connector.
4. Turn water on and allow water to flush the engine and exhaust manifold for five to ten minutes.
5. Turn water off. Disconnect hose; replace and tighten cap securely.

**CAUTION**

Reinstall cap onto coupler after flushing. Flooding of the engine compartment will occur if the cap is not installed and tightened.

O - 3 GENERAL MAINTENANCE SCHEDULE

* Or As Required

SERVICE	At Launch and First Operation*	25 Hour Check each Season*	Bi-Seasonally or Every 6 Months or Every 100 Hours*	Seasonally or Every 12 Months or Every 200 Hours*
Engine and Drive Systems		Refer to Section B		
Engine Maintenance	As Recommended by the Manufacturer			
Inspect Water Intake Connections and Hoses	■	■	■	
Inspect Exhaust System Hoses and Connections	■	■	■	
Check Propellers				■
Check All Thru-Hull Fittings	■			■
Test Emergency Shut-Off Switch	■		■	
Gauge Cleaning			■	■
Control Systems		Refer to Section C		
Throttle and Shift Adjustment		■		■
Neutral Safety Switch Test				■
Cable and Control Lubrication				■
Steering Systems		Refer to Section D		
Linkage and Connection Inspection			■	■
Stern Drive Torque Tab Adjustment				■
Power Steering Service	As Recommended by the Manufacturer			
Steering Adjustments				■
Steering System Lubrication				■
Electrical Systems		Refer to Section E		
Inspect Battery Connections			■	■
Check Battery Water		■	■	■



SERVICE	At Launch and First Operation*	25 Hour Check each Season*	Bi-Seasonally or Every 6 Months or Every 100 Hours*	Seasonally or Every 12 Months or Every 200 Hours*
Battery Cable Inspection				■
12 V. Electrical Equipment Operation		■		■
12 V. Wiring and Connection Inspection				■
Fuel Systems		Refer to Section F		
Inspection for Leaks		■	■	■
Fuel Sender Inspection				■
Fuel Filter Inspection		■	■	■
Tank Inspection				■
Fresh Water Systems		Refer to Section G		
Flush Water System				■
Water Tank Inspection				■
System Inspection		■		■
Ventilation and Drainage		Refer to Section H		
Blower Operation		■	■	■
Blower Vent System Cleaning			■	■
Bilge Pump Operation and Cleaning		■	■	■
Check Transom Drain Plug	■		■	■
Hatch Window Operation				■
Interior Equipment		Refer to Section I		
Head Maintenance	As Recommended by the Manufacturer			
Thru-Hull Fitting Inspection	■	■	■	■
Ice Box and Refrigerator Cleaning				■
Stove Fuel System		■		■
Stove Maintenance	As Recommended by the Manufacturer			
Stereo Head Cleaning and Demagnetizing				■
Hatch Screen Cleaning				■
Exterior Equipment		Refer to Section J		
Clean Spotlight			■	■
Check Compass for Magnetic Deviation				■
Check Trim Tab Fluid Level		■	■	■



SERVICE	At Launch and First Operation*	25 Hour Check each Season*	Bi-Seasonally or Every 6 Months or Every 100 Hours*	Seasonally or Every 12 Months or Every 200 Hours*
Check Trim Tab System for Leakage				■
Upholstery		Refer to Section K		
Clean Upholstery				■
Spray Upholstery with Lysol				■
Check Convertible Seat Hinges and Swivels				■
Weather Covers		Refer to Section L		
Wash Weather Covers				■
Spray Weather Covers with Lysol				■
Fiberglass Components and Hull		Refer to Section M		
Check all fastenings securing rails, seats, etc.				■
Clean Fiberglass Thoroughly			■	■
Wax Hull Sides and All Non-tread Areas				■
Inspect Fiberglass Areas for Damage				■
Perform Minor Touch-up Repairs				■
Sand Hull and Re-apply Anti-fouling Paint				■
Wood & Composites Care and Maintenance		Refer to Section N		
Apply Teak Care Products	As Needed			
Clean Star board Parts				
Clean Ash Trim and Tables				■
Trailer		Refer to Section P		
Wax Trailer		■	■	■
Lubricate Trailer Jack		■	■	■
Lubricate Trailer Coupler			■	
Lubricate Trailer Winch		■	■	■
Brake Operation	Before Every Use			
Brake Inspection			■	■
Hub/Drum				■
Inspect Bearings & Seals			■	■
Lubricate Bearings		■	■	
Springs, Hangers, & Suspension Parts				■



SERVICE	At Launch and First Operation*	25 Hour Check each Season*	Bi-Seasonally or Every 6 Months or Every 100 Hours*	Seasonally or Every 12 Months or Every 200 Hours*
Wheel Lug Nut		■	■	■
Wheels			■	■
Tire Pressure & Condition	Before Every Use			



TRAILER INFORMATION

P - 1 GENERAL TRAILER INFORMATION

The trailer must properly "match" the boat's weight and hull design. Four Winns trailers are designed specifically for each boat model. This will prevent any problems related to trailer capacity or improper support. Four Winns trailers meet or exceed the National Marine Manufacturers Association's trailer requirements.

Four Winns, Inc., manufactures bunk type trailers. The bunks are located specifically for Four Winns boats and adequately support all parts of the boat. It is a "drive-on" type trailer which means winching the boat from the water is not necessary.

NOTICE

When winching the boat onto the trailer, be sure the bunks are wet to prevent damage to the boat or trailer. **DO NOT** attempt to winch the boat forward when out of the water. Damage to the winch stand/assembly or tongue could occur.

Four Winns offers both painted and galvanized trailers. The painted trailer is intended to be used in fresh water and the galvanized trailer in salt/brackish water.

A. Regulations

Federal law requires that the trailer and tire registration information be compiled and recorded. The Four Winns boat registration card includes trailer registration information. A trailer tire warranty card provided with this manual, is to be filled out and returned to the tire manufacturer.

Laws covering such items as trailer brakes, lights, safety chains, etc., will vary from state to state. Please contact the motor vehicle department in your state for additional information.

B. Load Carrying Capacity

The certification label shows the maximum load-carrying capacity and is located on the port forward side of the trailer. The Gross Vehicle

Weight Rating (GVWR) is the load-carrying capacity plus the weight of the trailer itself. **DO NOT** exceed the GVWR rating for the trailer.

If selecting a trailer from another manufacturer, check the load-carrying capacity. A trailer with a load-carrying capacity that is too low will be unsafe on the highway and could cause sudden failure of critical trailer components or abnormal tire wear. A trailer with too high of a load-carrying capacity that is sprung for heavy loads can damage a lighter boat.

NOTICE

DO NOT overload your trailer by placing camping gear or other heavy equipment in the boat. **DO NOT** exceed the GVWR rating. Damage to the hitch, coupler, or trailer may occur.

Improper weight distribution can place excessive strain on the towing vehicle and trailer. It can also cause the trailer to "fishtail" (sway side to side). Be sure gear and other items are distributed evenly in the boat.

C. Hitches

The load-carrying capacity of trailer hitches will vary between manufacturers and must equal or exceed the GVWR. Four Winns trailers use surge brake systems and require a fixed hitch. Refer to Section P-2e Surge Brakes for more information.

Before hitching the trailer to the vehicle, make sure the proper size hitch ball is installed to match the coupler. Please refer to the coupler or actuator on the trailer for ball size. Four Winns trailers require a 2" hitch ball on all sport boat model trailers except the 245 Sundowner. The 245 Sundowner uses a 2 5/16" hitch ball. Refer to Section P-3 Operation for additional information on hitches. Also, consult your Four Winns dealer for his recommendation before purchasing a trailer hitch for your towing vehicle.



WARNING

To help guard against a sudden failure while in use, **DO NOT** use a worn hitch ball. Replace all worn or damaged parts.

P - 2 TRAILER COMPONENTS

A. Bunk Supports

All bunk boards are made of pressure treated wood. This wood is rot resistant. All boards are covered with a high quality exterior grade carpet to protect the boat from damage during normal use.

Bunk supports run parallel to the keel and support the hull, extending beyond the transom. See Figure P1.



Figure P1: Trailer Bunks

Outer bunk supports provide stability for the boat. The inside bunks are the main weight bearing members. Side guide-on supports help to keep the boat straight while driving the boat onto the trailer. Keeping the tie-downs tightly fastened will prevent the boat from bouncing against the bunk supports.

NOTICE

Improper trailer set-up can cause hull damage.

B. Tongue

Four Winns trailers are designed with tongue weights between 5% and 10% of the total weight of the boat, fuel, gear and trailer. If the down-

ward weight on the coupling ball does not fall within this range, coupler failure and towing instability may occur. If using another manufacturer's trailer, have the dealer check the tongue weight before trailering.

NOTICE

DO NOT use a bent or damaged tongue or coupler. Replacement parts may be ordered through a Four Winns dealer.

On most trailers, the trailer tongue can either be removed or pushed into the trailer frame for easier storage. The tongue is attached with two clevis pins with hair pin cotters to the trailer frame. Refer to Figure P2.

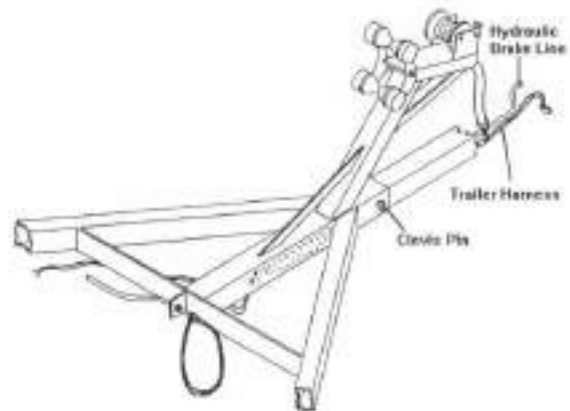

Figure P2: Trailer Tongue Assembly

To remove the tongue:

1. Make sure the trailer jack is supporting the trailer load properly. Refer to Section P-2c on Swivel Jacks for additional information.
2. Unplug the wire harness at the trailer cross member.
3. Disconnect the brake line coupler.
4. Remove the hair pin cotters and clevis pins.

NOTICE

The tongue will exert some pressure on the clevis pins. It may be necessary to lift, push or wiggle the tongue to remove the clevis pin.



- Slide trailer tongue out of receiver and store in a proper place.

To reinstall, follow this procedure in reverse order.

CAUTION

Make sure the trailer tongue is secure before hitching to the towing vehicle.

C. Swivel Jack

The jack is designed to lift, lower and support the tongues of the trailers when not connected to the towing vehicle. Before unhitching the trailer, use the following guidelines when setting up the jack.

- Pull on the lock pin. See Figure P3.
- Swivel jack to the vertical position.

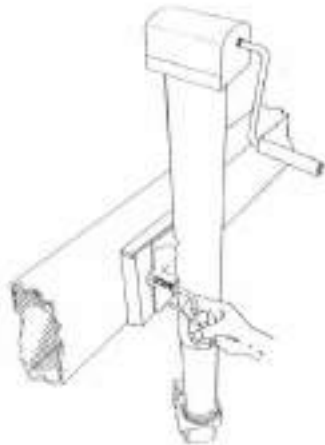

Figure P3: Swivel Jack

- Release the lock pin and make sure the pin fully engages the attached tongue bracket.

CAUTION

Be sure dirt, sand, ice, etc., does not obstruct the proper seating of the lock pin.

- When raising or lowering the jack, prevent the caster from rotating while cranking. Make sure the jack is planted on a firm and level surface before unhitching the trailer.

WARNING

To prevent personal injury or damage to the boat and trailer, observe the following.

- NEVER pull on the lock pin when any trailer weight is on the trailer jack.
- DO NOT move the trailer when resting on the swivel jack. Use towing vehicle to move the boat and trailer.
- Keep body and feet clear of trailer tongue when raising or lowering jack.

Always remember to swivel jack to the horizontal position before towing the trailer. Damage to the caster and jack may result.

The swivel jack provided on the Four Winns trailer can be removed from the trailer to allow for maintenance or repairs. Follow the manufacturer's recommendations provided with this manual.

D. Coupling Assembly

To unlock the coupler, pull the locking trigger upward with your index finger and lift the locking lever. To lock, push the locking lever down. See Figure P4.

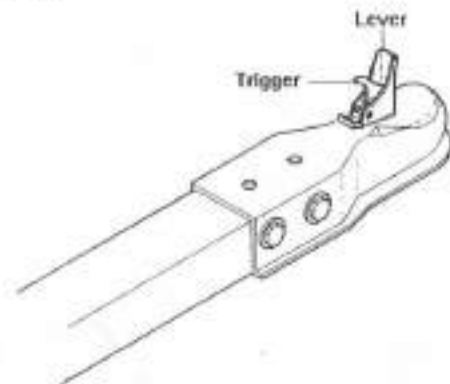

Figure P4: Coupling Assembly

This is also applicable to the Surge Brake Actuator and Coupling Assembly used on the 245 Sundowner Model depicted in Figure P5.



E. Surge Brakes

Brakes are available on all trailers manufactured by Four Winns, Inc. Surge brakes operate automatically when the tow vehicle's brakes are applied. When the tow vehicle slows down or stops, the forward momentum or "surge" of the trailer against the hitch ball applies pressure to a master cylinder in the trailer coupler. This pressure activates the trailer brakes through the brake's hydraulic system. See Figures P5 and P6.

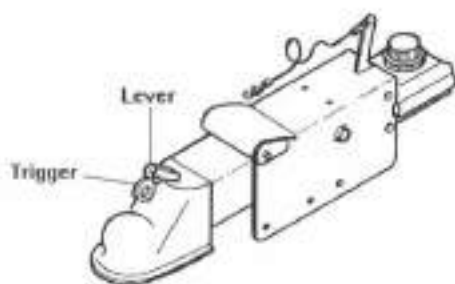

Figure P5: Surge Brake Actuator & Coupling Assembly (245 Sundowner Model)

For boat models with the Surge Brake Actuator and Coupling Assembly shown in Figure P6, lift the release handle to unlock the coupler. The optional locking pin or a padlock may be inserted in the locking lever hole to secure the trailer. Refer to Section P-3 Operation for additional information on couplers and hitching to the tow vehicle.

NOTICE

Anti-sway devices as used on recreational vehicles (RV's) are not applicable to surge brake systems and should not be used on Four Winns trailers.

DO NOT use a trailer hitch with moving parts. The brakes could activate when traveling downhill. Always use a fixed hitch.

If the brakes are wet from loading, travel at a slow speed and apply the brakes on your towing vehicle several times to "dry" out the trailer brakes.

Release handle must be held in fully open position to remove from or place on ball.

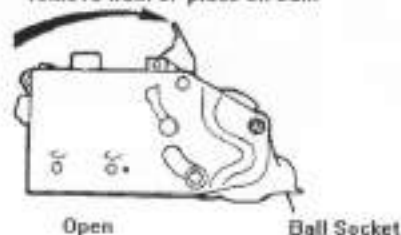

Release handle must be fully closed before towing.

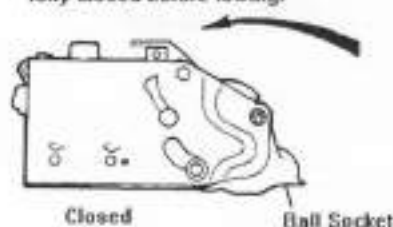

Figure P6: Surge Brake Actuator & Coupling Assembly

For maintenance and other information, refer to the manufacturer's literature included with this manual.

F. Winch

Winch operating instructions are listed below.

To release the winch, place the ratchet in the REVERSE or NEUTRAL position. The winch handle may spin when pulling on the winch line.

CAUTION

To prevent personal injury, observe the following:

A spinning winch handle can cause injury. Be sure the area is clear.

DO NOT release the handle when the ratchet is disengaged. Be sure the ratchet is engaged or no load is on the winch before releasing the handle.



CAUTION

To prevent personal injury, ALWAYS inspect the winch line and hook before each use. NEVER use line that is worn or frayed. NEVER let anyone stand in or behind a boat while pulling with the winch.

To rewind the winch, ALWAYS engage the ratchet first. Turn the handle in the appropriate direction to rewind the line.

CAUTION

A clicking sound will be heard when the winch is properly engaged. If a clicking sound is not heard, DO NOT release the handle. Handle may spin backwards. Lower the load into a safe position before releasing the handle.

Refer to the manufacturer's literature included with this manual for more information on winch operation.

G. Wheels

Trailer wheel rims are available in three types of finishes: white, aluminum and galvanized. The white, powder coat finish is standard. Aluminum rims (Mags) are optional on painted trailers. Galvanized trailers are equipped with matching galvanized rims. Spare tire covers are available as an option and will match the trailer. Refer to P7.

The tires installed on Four Winns trailers meet the trailer load requirements for each model. Before trailering, make sure the tires are inflated according to the manufacturer's recommendation. Tire pressure information is noted on the tire and on the manufacturer's literature.

Lug nuts must be checked for proper tightness after the first 50 miles and periodically thereafter. Lug nuts should be torqued to 85 foot pounds on white, galvanized, and aluminum wheels.

Mag wheels include a locking-type nut to help deter theft. This nut requires a special key or socket to remove. The socket will be included

with your trailer when mag wheels are ordered. Refer to Figure P8.

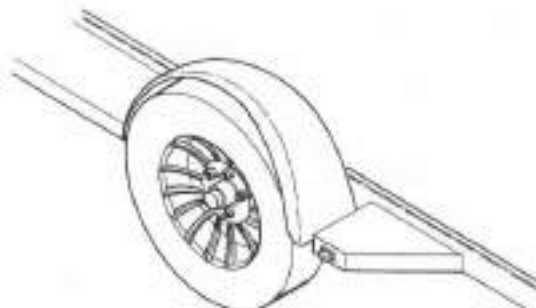

Figure P7: Mag Wheel



Figure P8: Mag Wheel Key (Socket)

NOTICE

DO NOT use an air wrench or other power equipment to install lug nuts on aluminum (Mag) wheels. Damage to the wheel may result. Lug nuts should be torqued to 85 foot pounds.

Examine the tires frequently for snags, bulges, excessive tread wear, separations or cuts.

Refer to the manufacturer's literature included with this manual for more information.

H. Spare Tire Carrier

Spare tires are optional on all Four Winns trailers. A spare tire carrier is bolted to the trailer frame and is available in painted or galvanized finish. A spare tire carrier and wheel can be ordered from your Four Winns dealer. Refer to Figure P9.

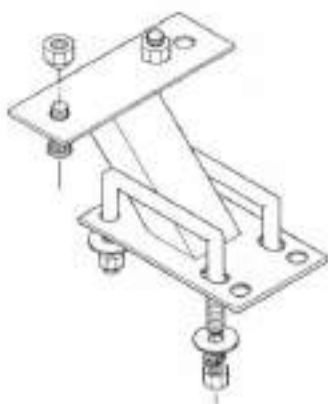

Figure P9: Spare Tire Carrier

I. Lights

Four Winns trailers are equipped with taillights, brake lights, turning signals, and clearance lights. All lights are sealed to prevent moisture from entering. However, the taillight bulb assembly may be replaced. The bulb is assembled in a sealed housing and can be replaced. Contact your Four Winns dealer for assistance.

NOTICE

Use a heavy duty turning signal flasher on towing vehicles. Check with your local auto parts store or ask your Four Winns dealer for assistance.

Consult your dealer for state trailer regulations concerning lighting and other optional equipment.

J. Tie-downs

The boat should be secured to the trailer by tie-downs to prevent damage to the hull. The boat may shift or bounce against the bunks or hull supports if not secured. It may also slide or fall off the trailer while being towed.

There are two types of tie-downs being used:

1. **Bow Tie-downs:** A bow stop to hold the front of your boat in place is located on the winch stand. It should be positioned so that the winch line pulls straight and is parallel to the trailer frame. A separate tie-down should then be attached to hold the boat. See Figure P10.

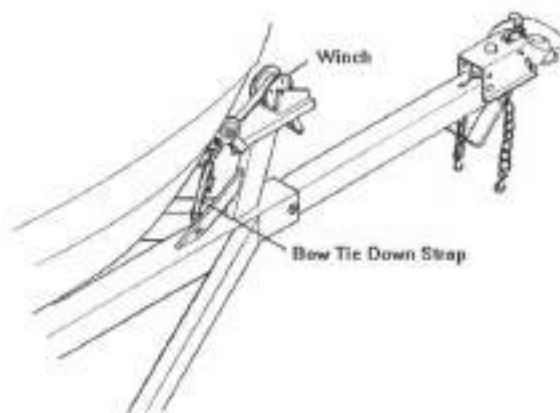
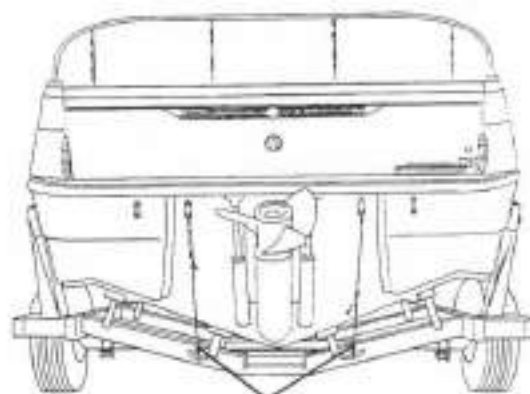

Figure P10: Bow Tie Down Strap

NOTICE

DO NOT rely on the winch cable (or line) alone to hold the bow of the boat against the bow stop. A bow tie-down is provided with the Four Winns trailer.

2. **Rear Tie-downs:** It is very important that the transom is resting securely on the bunk supports at the rear of the trailer. Rear tie-downs are provided to secure the boat to the trailer. Tighten the tie-downs to prevent the boat from moving. See Figure P11.



Rear Tie Down Straps

Figure P11: Rear Tie Down Straps

The tie-down is a mechanical ratcheting device. To allow line out, follow the procedures below:



1. Place two fingers on spring-loaded release, and pull release away from spindle/gear.
2. Open tie-down to a flat, 180° position.

NOTICE

Spring-loaded release should click into a notch on the painted handle. Both spring releases should clear the inner gear.

3. Pull line out. The inner spindle/gear should move freely.

To ratchet line or tighten down the strap on the boat:

1. Place two fingers on spring-loaded release, and pull release away from spindle/gear.
2. Bring both handles together. Both handles should ride on the inner gear.
3. Open (to approximately 110°) and close handles to ratchet. Leave in closed position to maintain pressure on line.

P - 3 OPERATION

A. Hitching Trailer

Before towing, the trailer must be properly hitched to the tow vehicle.

1. Position actuator ball socket above ball hitch.
2. Hold release handle in open position. See Figure P6.
3. Lower trailer tongue until ball is seated or rests in ball socket.
4. Close release handle.

The release handle will close freely with finger pressure when ball is properly seated in socket. If the handle does not close freely, do not tow trailer. **DO NOT** force handle into closed position. Inspect actuator for bent parts or cause of improper operation.

NOTICE

Keep the coupler clean and lubricated to prevent damage to the coupler.

5. Make sure the actuator is secure. If unsure, extend the trailer tongue jack to the ground and lift (with the jack) the car and trailer combination approximately 2" to 4". If the ball does not disengage and remains secured, the actuator is latched properly.

NOTICE

To prevent back injury, **DO NOT PHYSICALLY LIFT** the trailer tongue when loaded.

6. Insert padlock or bolt through lock hole to protect from theft.
7. Connect breakaway cable solidly to bumper or frame of tow vehicle and should be as near to center as possible. The cable should hang clear of trailer tongue and be long enough to permit short radius turns without pulling breakaway cable forward.
8. Make sure breakaway cable is in released position with indicator bead touching or resting against cable spring stop. See Figure P12.

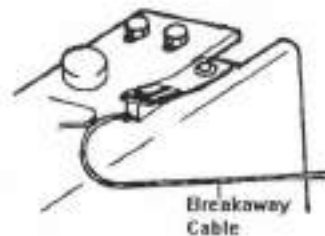



Figure P12: Breakaway Cable

CAUTION

DO NOT use breakaway cable as a parking brake.

9. Safety chains are provided and must be used. Cross the safety chains under the coupling and attach to the towing vehicle's frame or bumper. Always allow slack for turns.



 **WARNING**

To reduce the risk of breakaway accidents, be sure coupler is seated and safety chains crisscrossed before trailering.

10. Retract jack fully and place in trailering or horizontal position.
11. Check for proper tow vehicle-trailer hook-up. The tow vehicle and trailer should be level with a positive tongue load. Four Winns trailers are designed with tongue weights between 5% and 10% of the total weight of the boat, fuel, gear and trailer. The trailer should be close to level. If unsure of tongue load and trailer position, consult your Four Winns dealer before proceeding.

Be sure to read the manufacturer's literature included with this manual before towing your Four Winns boat and trailer.

B. Backing Up

Follow the steps listed above for hitching the trailer before backing up.

1. Before backing up a slope or through soft ground, pull the trailer forward slightly to assure the actuator socket is in the fully forward position.
2. Move the lever knob on the side of the actuator downward from the "Towing Position" along the curved slot in the actuator frame to the "Back-up Position". Refer to Figure P6. The slot has a notch at the bottom of its travel. Push the lever knob down to engage the locking notch.
3. Back the trailer up.

 **CAUTION**

Avoid sharp turns. This could bend, create extreme stress or fracture either the actuator or trailer tongue.

NOTICE

Be sure to check for obstacles or persons behind the trailer before backing up. Also, adjust your mirrors for clear view of the area behind the trailer.

4. If the trailer is to be uncoupled from the tow vehicle after backing with the lever knob engaged, block all trailer wheels and pull forward slightly to take strain off the actuator.

Uncouple the actuator by lifting the release handle and raise the trailer tongue with the jack.

 **CAUTION**

BEFORE TOWING, ALWAYS ENSURE THE LEVER KNOB HAS DISENGAGED AND IS IN THE "TOWING POSITION"

NOTICE

Trailer components may be different between models and may change during the model year. Be sure to read all manufacturer's literature supplied with your Four Winns trailer.

P - 4 TRAILERING

A. Checklist

Before trailering, the trailer should be inspected for the following:

1. Check tires for proper inflation. Under-inflated tires heat up rapidly and may blow-out or cause uncontrolled swaying. Also, make sure lug nuts are tight.
2. Be sure the coupler is secured to the trailer hitch and safety chains are attached.
3. Be sure trailer taillights and turning signals are operational.
4. Check the brakes for proper operation prior to departure.
5. Check lug nuts for proper tightness.



6. Check tie-downs and make sure boat is secured to the trailer.
7. Check the springs and under carriage for loose parts.
8. Before towing, close and secure all hatches, doors, and windows. Securely store all equipment and canvas. Installed tops, side curtains, and aft curtains can be damaged while towing.
9. Carry a spare tire for both the trailer and towing vehicle. On extended trips, carry spare wheel bearings, seals, and races. Be sure and carry the proper tools to complete the repairs.

**WARNING**

To avoid bearing failure and possible wheel loss, keep wheel bearings properly lubricated. Inspect the wheel bearings periodically and check for damage.

10. Before trailering, inspect the bearings for wear and adequate lubrication. When traveling, check the wheel hubs during stops at gas stations, restaurants or other places. If the hub feels abnormally hot, the bearing should be inspected before continuing the trip.

B. Tactics**NOTICE**

Be sure to check the towing vehicle manufacturer's literature for recommendations on towing.

1. Install outside rear view mirrors on both sides of the towing vehicle to improve vision. Check the rear view mirrors at frequent intervals to be sure trailer and boat are riding smoothly.
2. Allow at least one car and trailer length between vehicles for each 10 mph. **DO NOT** tailgate.
3. Use low gear (on manual transmissions) when traveling up steep hills or over sand, gravel, or dirt roads.

4. Use care if shifting to a lower gear while traveling downhill. This could activate the trailer's surge brakes for the duration of the downhill run and cause overheating. Extended overheating could result in complete loss of the trailer brakes.

To help prevent overheating, slow down while approaching the crest of a hill and maintain a slow, controlled downhill speed. Apply brakes in short intervals to allow time between braking for the brakes to cool off.

5. When rounding turns on highways or streets, **DO NOT** cut corners. Also, travel slowly over railroad tracks.
6. If the trailer begins to "fishtail" when accelerating, reduce speed until it ceases. If the trailer "fishtails" again during acceleration, stop to investigate the cause of the problem. Check for improper trailer load and uneven weight distribution inside the boat. Check the winch line and tie-downs. Also check the tires for proper inflation or damage. If necessary, redistribute the load before continuing.

NOTICE

Before backing the trailer into the water, disconnect the trailer light plug from the towing vehicle. This will greatly reduce the likelihood of blowing out trailer lights or fuses on the towing vehicle, and give extra time for the hubs to cool down. Be sure to carry extra fuses for the towing vehicle.

For additional information on trailering, refer to the Boating Basics manual included with this manual.

P - 5 MAINTENANCE**A. Care of Exterior Finish**

When using the trailer, keep in mind the paint can scratch and become marred during normal use. Paint touch up kits can be ordered from Four Winns Customer Service department. Contact a Four Winns dealer for assistance.



Some maintenance is required to maintain the finish and minimize rusting. The trailer should be washed and rinsed with clean water immediately after each use. On galvanized trailers, rinse only with clean water. Depending upon use, waxing is recommended twice a year. Use paste wax designed for enamel paint.

B. Bunks

The bunks should be replaced if they are cracked, warped, or evidence of dry-rot is found. The replacement boards should be treated lumber of the same length and width.



CAUTION

DO NOT burn damaged or broken bunks. Toxic fumes will be released. Dispose of bunks properly.

C. Swivel Jack

Keep the swivel jack clean of dirt, tar, and mud. Lubricate every six months. The swivel jack's inner ram should be lubricated with SAE 30 weight oil. The top cover may be removed to lubricate the gears with wheel bearing grease.

Replace all worn and damaged parts. ALWAYS use the manufacturer's replacement parts. Replacement parts may be ordered through your Four Winns dealer.

For more information on maintenance, refer to the manufacturer's literature included with this manual.

D. Brake Actuator & Coupling Assembly

When storing or parking your trailer, keep the brake actuator and coupling assembly (coupler) off the ground to prevent dirt build-up in the ball socket. Keep the coupler clean of dirt, tar, and mud. Lubricate the coupler with SAE 30 weight oil every six months or as often as necessary. Replace any worn or defective parts. If the coupler is damaged, contact your Four Winns dealer for replacement parts. DO NOT use a damaged or bent coupler assembly.

For more information on maintenance, refer to the manufacturer's literature included with this manual.

NOTICE

The trailer should be set up at a slight angle to allow for water to drain aft in the boat.

E. Winch

The winch should be kept clean of dirt, ice, paint, etc., and the spur gears should have a film of grease on them at all times. Apply several drops of SAE 30 weight oil to the ratchet pawl mechanism, bushings and pinion shaft threads twice per season.

Replace any worn or damaged parts. For more information on maintenance, refer to the manufacturer's literature provided with this manual.

F. Lights

Inspect wiring for cuts or bare wire which could cause electrical shorts. Repair or replace defective wiring. Replace cracked or damaged lens and always carry spare bulbs. Replacement parts may be ordered through a Four Winns dealer.

G. Tie-downs

Replace frayed or damaged tie-downs. Periodically, lubricate the ratchet mechanism with a fine oil or silicone spray. Replacement parts may be ordered through a Four Winns dealer.

H. Wheels

Some maintenance is required to maintain the finish and retard rusting of painted rims. The wheels should be cleaned with dishwashing soap and water and rinsed with clean water immediately after each use. Waxing is recommended three to four times each year.

Aluminum wheel rims may be cleaned with dishwashing soap and water. However, cleaning products specifically for aluminum are available and can be used. Cleaners may be obtained from Four Winns dealers and your local auto



parts stores. The Mag wheel manufacturer recommends a product by Priority One called "Pro-Long Aluminum/Chrome Wheel Protectant". Galvanized rims should be rinsed only with clean water immediately after each use.

NOTICE

ALWAYS read the manufacturer's instructions on the label before using any product.

I. Brakes

Keep the actuator clean of dirt, tar, and mud. The actuator and internal parts should be lubricated at all times with SAE 30 weight oil. The hitch ball may be lubricated with automotive grease or lubricant made for hitch balls.

Periodically inspect the brake system for leaks. Check all hoses for cuts or wear. Replace all defective hoses. The master cylinder should be filled within 1/2 inch from the top of the reservoir. At the beginning of each year, inspect the brakes for excessive wear, have linings replaced if necessary.

If the brakes need bleeding, consult your Four Winns dealer for assistance. If unavailable, a brake or auto repair facility can perform the repair.

Refer to the manufacturer's literature with this manual for additional information on the brake system.

J. Bearings

Wheel bearings and seals should be inspected at the same time as brakes. Have worn or defective parts replaced. Grease bearings and seals at this time and at the end of the boating season. Lube Bearing Protectors should be greased three to four times a year. A grease fitting is provided.

NOTICE

Most bearing failures are due to improper maintenance. Be sure to inspect bearings and seals as noted in Section P-6b and refer to the manufacturer's literature included with your trailer.

P - 6 AXLE INSPECTION & REPAIRS

As a general rule, have all repairs and maintenance should be performed by qualified servicing personnel. Our axle manufacturer recommends that a certified mechanic should be consulted on the following items:

1. Broken axle
2. Broken spring
3. Worn spring eye bushing parts
4. Sagging springs
5. Welding fatigue
6. Serious leakage of seal
7. Tire wear
8. Loose or worn suspension parts
9. All brake related adjustments, inspections and problems

A. Removal of Hub

The following instructions pertain only to trailers manufactured by Four Winns. To remove the hub to inspect the bearings and seals, refer to Figure P13 and the following instructions:

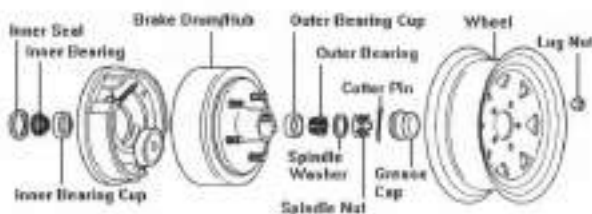

Figure P13: Axle Components

1. Remove lug nuts.
2. Remove wheel.
3. Remove grease cap.
4. Remove cotter pin.
5. Unscrew the spindle nut counter clockwise.
6. Remove spindle washer.
7. Remove hub from spindle.



B. Bearing/Seal Inspection and Replacement

When inspecting bearings or seals:

1. Inspect the grease seal for damage, tears, or cracks. If there is no damage or leakage in not occurring, the seal is in good condition.

If the seal is torn or cracked, then it should be replaced. The seal can be pried out of the hub with a screw driver. Be sure to replace the seal using the recommended replacement parts. Parts can be obtained from your Four Winns dealer.

2. When inspecting the bearing, check for corrosion and wear. If any rust or wear exists on the bearing, then remove and replace with the recommended parts listed in the table above.
3. If the bearings are in good condition, repacking the grease should be done at this time. Hand pack each bearing individually using a premium water resistant wheel bearing grease.

C. Hub Reinstallation

1. To reinstall hub, reverse the procedures listed above.
2. It is important to tighten the spindle nut to approximately 50 ft. lbs. (12" wrench with full hand force). Loosen the nut then finger tighten.
3. Replace the cotter.
4. When reinstalling wheel, the following tightening procedure is recommended by the manufacturer:
 - a. Place wheel lug nuts on by hand to start.
 - b. Tighten initially to 15 - 20 ft. lbs. (Apply 20 pounds of pressure to wrench 12" long) using cross tightening sequence. Proceed to finish tightening to 85 ft. lbs. (Applying 85 pounds of pressure to wrench 12" long will yield 85 ft. lbs. of torque).

- c. Re-torque after first 50 miles of use.

Refer to Section P-2g for additional information on wheel requirements.



OPERATION

Q - 1 GENERAL

Before starting the boat, become familiar with all of the various systems and related operations. Be sure all necessary safety equipment is on-board. Know the "Rules of the Road". Have an experienced pilot brief you on the general operation of your new boat. Perform a "Pre-Cruise Systems Check".

Q - 2 COMPONENT SYSTEMS

Before you can really enjoy your boat, a thorough understanding of its systems and their operation is essential. This manual and the associated manufacturers information are provided to enhance your knowledge of the boat. Read this information carefully.

After becoming familiar with the boat and its systems, re-read this manual. Maintenance and service tips are included to help keep the boat in like-new condition.

Q - 3 SAFETY EQUIPMENT

Besides the equipment installed on the boat by Four Winns, Inc., certain other equipment is required for passenger safety. A brochure listing the Federal equipment requirements is included with this manual. Remember that these laws are for your protection and are minimum requirements. Check your local and state regulations, also.

Items like a sea anchor, working anchor, extra dock lines, flare pistol, a line permanently secured to your ring buoy, etc. could at some time save your passengers lives, or save your boat from damage.

The Coast Guard Auxiliary offers a "Courtesy Examination." This inspection will confirm the boat is equipped with all of the necessary safety equipment.

Q - 4 PASSENGER SAFETY

You are responsible for the safety of your passengers as well as for their behavior while aboard. Make sure:

1. Each passenger is properly instructed in Personal Flotation Device (PFD) use and keeps one within reach in case of emergency. Children should wear a PFD at all times when underway.
2. Passengers do not sit on gunwales, open decks, elevated pedestal seats or on seat backs when the boat is underway. This could cause them to be thrown overboard during a sudden maneuver.
3. At least one other person knows how to operate the boat in case of an emergency.

Q - 5 RULES OF THE ROAD

As in driving an automobile, there are a few rules that must be known if safe boating operation is to be maintained. The Coast Guard, Coast Guard Auxiliary, Department of Natural Resources or your local boat club sponsor courses in boat handling, including rules of the road. Such courses are strongly recommended. Books on this subject are also available from local libraries.

Q - 6 LIGHTNING

When boating, it is important to be aware of the weather around you. When the weather changes for the worse, DO NOT jeopardize your safety by trying to "ride out the storm". If possible, return to safe harbor and dock your vessel immediately.

If caught in a storm, seek shelter inside the cabin and wait for the storm to pass. With open bow models, suntops and campers will provide some protection, but should not be relied on if you are able to return to shore. Exercise care when high winds are present!

**WARNING**

DO NOT swim or dangle legs or arms into the water during a lightning storm. Stay out of the water!

Lightning will seek a ground when it strikes. Avoid contact with metal parts such as bow rails, control handle, or windshield.

Q - 7 DRINKING AND DRIVING

Please keep in mind that along with the fun of boating comes responsibility. As the owner or operator of a pleasure boat, you are obligated (morally and legally) to use good judgement while underway in providing for the safety and well-being of your passengers and other boaters around you.

A common and flagrant violation of good judgement by mariners involves the use of alcohol or drugs. Each year, about half of all accidents involving fatalities involve the use of alcohol or drugs.

Laws enacted in 1984 make it a federal offense to operate a boat while intoxicated. Criminal penalties may include the termination of operating privileges for up to one year. Many states have passed similar laws.

Alcohol or drugs have an inhibiting effect on the judgement and reaction time of the helmsmen. Heed the advice of experts and statisticians...DO NOT drink or use drugs when operating a boat. NEVER allow an obviously intoxicated person to take the helm.

Have fun in your Four Winns boat but also, have the good sense to be mentally alert and physically capable of operating the boat in a safe manner.

Q - 8 PRE-CRUISE SYSTEM CHECK

Before leaving the dock, the following items should be checked:

A. Before Starting The Engine

1. Check the weather forecast. Determine if the cruise planned can be made safely.
2. Check the bilge water level and bilge pump operation. Check the engine and drive fluid levels. Look for other signs of potential problems. Check for the scent of fuel fumes.
3. Set the Battery Selector Switch to the desired position. See Section E Electrical Equipment.
4. Activate the Bilge Blower. Check the blower output.
5. Be sure all necessary safety equipment is on-board and operative. This includes items such as the running lights, horn, spotlight, life saving devices, etc.
6. Be sure the dockside shore power cord is disconnected (if applicable).
7. Be sure the dockside water supply line is disconnected (if applicable).
8. Ensure an adequate amount of fuel is on board.
9. Be sure you have sufficient water and other provisions on board for the cruise planned.
10. Leave a written message listing details of the planned cruise with a close friend ashore.

B. After Starting The Engine

1. Visibly check the engine to be sure there are no apparent water or oil leaks.
2. Check the gauges. Make sure the oil pressure, water temperature, voltmeter, etc. are reading normally.
3. Have a safe cruise and enjoy yourself.



Q - 9 ENGINE OPERATIONAL PROCEDURES

A. Before Starting

1. Check the engine compartment for water, gas, and/or oil leaks of any kind. Keep the bilge in a clean condition to prevent blower and bilge pump damage, and fire hazards.
2. Check the fluid levels of the engine oil and power steering system daily. Fill oil or steering fluid as required by the indications on the dip sticks. Use an SAE 30 motor oil. **DO NOT USE MULTIGRADE OIL.** Power steering, power trim, and trim tabs use automatic transmission fluid. Check the fluid levels in the vertical drive units or transmission as often as practical.
3. Start and operate the bilge blower system for at least four (4) minutes before start-up.
4. Lower the vertical outdrive units (on applicable models) making sure the water intakes are under the water.
5. Attach the lanyard to the emergency ignition cut-off switch. Engine will crank but will not start if lanyard is not in place. Attach the other end of the lanyard to a secure place on your clothing.

B. Cold Engine Start

1. The engine may require priming prior to starting. To prime the engine, proceed as follows:
 - a. Place ignition switch in the OFF position.
 - b. Disengage shift mechanism.
 - c. Move control handle to the full throttle position; this operates accelerator pump and primes the engine.
 - d. Repeat priming, if necessary.
 - e. Return the control handle to fast idle position.

2. Turn key switch to START position and hold until engine starts. **DO NOT** hold in START position for more than ten seconds. In colder weather, more priming may be necessary. However, too much priming may flood engine.

If engine floods:

- Disengage shift. Move handle to full throttle position.
- Turn key switch to the START position.
- Immediately move the control handle to the idle position when the engine starts.

NOTICE

Failure to move the control handle to the idle position immediately when engine starts will allow engine to overspeed and engine damage could result. Over speeding engine after off-season storage could also damage the water pump impeller. **When starting engine for the first time after off-season storage, always idle engine for one minute to allow the water pump to prime.**

3. As soon as engine starts:
 - a. Release key to the ON or RUN position.
 - b. Move control handle to the fast idle position to warm up engine. **DO NOT** exceed 1000 RPM.

NOTICE

Cold engine starting procedures are different for EFI engines. Priming is not necessary. Refer to the engine owner's manual for additional information.

C. Warm Engine Starting

1. Move control handle to the neutral detent position.
2. Turn key switch to START position and hold until engine starts, but **DO NOT** hold in start position for more than ten seconds. If engine does not start, let go momentarily, then try again.



3. As soon as engine starts, release key to the ON or RUN position.

NOTICE

NEVER turn key to START position when engine is running.

NOTICE

Warm engine starting procedures are different for EFI engines. Refer to the engine owner's manual for additional information.

D. Shifting and Control Speed

NOTICE

If your boat is equipped with a non-OMC remote control system, ask your dealer how to properly operate it.

1. Move control handle to the neutral detent (idle) position. This will engage neutral start switch and allow engine to start.

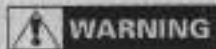

WARNING

DO NOT shift into FORWARD or REVERSE unless engine is running. Damage to the shift system could result from trying to shift without the engine running. Carefully check function of all control and engine systems before leaving the dock.

2. To go FORWARD - actuate the neutral lock mechanism and briskly move the shift handle forward. Throttle movement will begin after forward gear engagement.
3. To go in REVERSE - actuate the neutral lock mechanism and briskly move the shift handle rearward. Throttle movement will begin after reverse gear engagement.

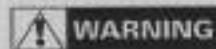

WARNING

DO NOT shift from forward to reverse when the boat is planing.

NOTICE

DO NOT shift if engine speed is above 800 RPM.

4. To go from FORWARD to REVERSE, or REVERSE to FORWARD; always pause at NEUTRAL and allow engine speed to return to idle.
5. After shifting is completed, continue to move the control handle slowly in the desired direction to increase speed.

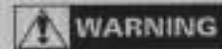

WARNING

Any time the boat is operated, be aware of changes in shift system operation. A sudden increase in shift effort at the remote control handle, or other abnormal operation, indicates a possible problem in the shift system. If this occurs, the following precautions must be taken:

- With engine running and boat securely tied to the dock, shift drive into forward and reverse to ensure there is gear engagement.
- When docking the boat, all docking maneuvers must be performed at slow speed. Pay special attention to other boaters. Passengers should be informed of potential problems and precautions taken.

If you suspect there is a problem, see your OMC Cobra dealer as soon as possible for proper diagnosis and required service or adjustment. Continued operation could result in damage to the shift mechanism and loss of control.

E. Stopping Engine

1. Move control handle to the NEUTRAL position.
2. Turn ignition key to the OFF position.

NOTICE

DO NOT stop engine at speeds above idle or "speed up" engine while turning off ignition. Engine damage could result. If propeller is not removed, personal injury could result.



Q - 10 GROUNDING AND TOWING

WARNING

If the boat should become disabled, or if assisting another craft that is disabled, great care must be taken. The stress applied to a boat during towing may become excessive. Excessive stress can damage the structure of the boat and create a safety hazard for those aboard.

Four Winns Boats are not designed nor intended to be used as a towing vessel. The mooring cleats on Four Winns boats are not designed or intended to be used for towing purposes. These cleats are specifically designed as mooring cleats for securing the boat to a dock, pier, etc. DO NOT use these fittings for towing or attempting to free a grounded vessel.

Freeing a grounded vessel or towing a boat that is disabled requires specialized equipment and knowledge. Line failure and structural damage caused by improper towing have resulted in fatal injuries. Because of this, Four Winns strongly suggests that these activities be left to those who have the equipment and knowledge such as the U.S. Coast Guard, to safely accomplish the towing task.

CAUTION

Running aground can cause serious damage to a boat and associated underwater gear. If the boat should become grounded, distribute personal flotation devices and inspect the boat for possible damage. Thoroughly inspect the bilge area for signs of leakage. An experienced service facility should check the hull and underwater gear at the first opportunity. DO NOT continue to use the boat if the condition of the hull or underwater equipment is questionable.

If towing or being towed is absolutely necessary, use the strongest lines available, and attach them to the bow eyes or stern eyes only. Have all passengers slip on life jackets and take a seat in the cabin or other protected area.

WARNING

Lines can snap or other hardware can be loosened or broken while towing. Under certain conditions, this can cause severe injury or fatality.

Q - 11 BOATING EDUCATION

A. Boating Courses

Boating education classes are offered throughout the country. The United States Coast Guard Auxiliary offers free courses on different topics usually during the off-season. The most popular course is the "Boating Skills & Seamanship Course," and information can be obtained by calling 1-800-336-BOAT.

The United States Power Squadron also offers free courses ranging from basic seamanship to celestial navigation. For information, contact your local Power Squadron, or write: U.S.P.S., P.O. Box 30423, Raleigh, NC 27622.

The Red Cross offers power boating and canoeing classes. Contact: Director of Water Safety, American National Red Cross, 17th & D Streets N.W., Washington, DC 20006.

The Canadian Power and Sail Squadron offers seamanship courses. Information can be obtained by calling 1-800-268-3579 (Canada only).

B. Boating Manuals or Literature

A good source of information is the U.S. Coast Guard's home study book called "The Skipper's Course". This book may be purchased through: Superintendent of Documents, U.S. Government Printing Office, Washington, DC 20402, Stock # 050-012-00159-6.

Another good source of boating information is Chapman's "Piloting, Seamanship and Small Boat Handling". Also, check the local library or bookstore for additional information on boating.



C. Charts and Maps

U.S. nautical charts are sold throughout the country at Governmental Printing Office stores and other agents. A chart catalog is available by writing to: National Oceanic and Atmospheric Administration, National Ocean Survey, Rockville, MD 20852.

In addition, many federal agencies publish recreational maps, including the U.S. Army Corp of Engineers, the Forest Service, the National Park Service, and the Tennessee Valley Authority.

Addresses of all state boating agencies are listed in "A Boater's Guide". For a free copy, write to: National Marine Manufacturers Association, 401 N. Michigan Avenue, Chicago, IL 60611.

Q - 12 GLOSSARY

ABAFT - Toward the rear of a boat.

ABEAM - At right angles to the keel of the boat.

ABOARD - On the boat.

ABREAST - Side by side.

ADRIFT - Loose, not on moorings or towline.

AFT - Moving toward the stern, you are going aft.

AGROUND - Stuck fast to the bottom.

AHEAD - In a forward direction.

ALEE - Away from the direction of the wind, opposite of windward.

ALOFT - Above the deck.

AMIDSHIPS - 1. An object or area midway between the bow and stern. 2. An object or area midway between the port side and the starboard side of a vessel.

AMPERE - The standard unit used to measure the draw of an electrical current.

ANCHOR RODE OR ROPE - The line (chain) connecting a vessel to its anchor.

ANCHOR BALL - A black, circular, day signal hoisted to show that a vessel is anchored. Replaced at dusk by the anchor light.

ASTERN - Anywhere behind the boat, a reverse direction, opposite of ahead.

ATHWARTSHIPS - A line, or anything else, running perpendicular to the fore-and-aft center line of a boat.

BATTEN - A strip of wood or metal used to secure tarpaulin(s) in place over a hatch. To batten down means to secure for rough weather.

BEAM - 1. The widest distance across a boat from the outside skin on one side to the outside skin on the other. 2. A transverse structural member that stiffens and supports a portion of the deck.

BEAM WIND - A wind blowing against the side of the vessel, perpendicular to the long axis of the vessel.

BILGE - The lowest interior area of a hull, used to collect water that has entered.

BILGE PUMP - A pump intended for removal of spray, rainwater, and the normal accumulation of water due to seepage and spillage; not intended for damage control.

BINNACLE - The stand or support for a magnetic compass occasionally used to mean helm.

BITT - A heavy and firmly mounted piece of wood or metal used for securing lines.

BLOCK - A wooden or metal case enclosing one or more pulleys and having a hook, eye, or strap by which it may be attached.

BOLLARD - A single post (wood, metal, or concrete) on a dock, pier, or wharf used to secure a vessel's lines.

BONDING - The electrical connection of exposed metallic, non-current carrying components to a common point on the main engine block.

BOW - The front end of the boat.

BOW LINE - A docking line leading from the bow.



BREAKER - A single breaking plunging or spilling wave.

BREAKER LINE - The outer limit of the surf. However, all breakers may not be in a line. They can occur outside the breaker line.

BRIDGE - The main vessel control station

BROACH - The turning of a boat parallel to the waves, subjecting it to possible capsizing.

BULKHEADS - The interior walls of a boat.

BULWARK - The side of a vessel when carried above the level of the deck.

BUOY - An anchored float used for marking a position on the water, a hazard, or a shoal.

CAPSIZE - To turn over.

CAPSTAN - A machine that moves a cylindrical device on a shaft for the purpose of hauling up an anchor.

CAST OFF - To let go.

CATAMARAN - A twin-hulled boat, with the hulls being side-by-side.

CHINE - The intersection of a boat's bottom and side. If this intersection is rounded, it is a "soft" chine. If the intersection is squared off, it is a "hard" chine.

CHOCK - 1. A fitting or hole in a railing or deck through which a mooring or anchor line is routed. 2. A wedge used to secure an item in place.

CIRCUIT BREAKER - A device used to interrupt an electrical circuit when current flow exceeds a predetermined level.

CLEAT - A double-ended deck fitting to which lines are secured; usually anvil-shaped.

COAMINGS - Raised lips around cockpits or hatches used to keep water from entering

COCKPIT - An exposed deck area (usually aft) that is substantially lower than the adjacent deck.

COMBER - A wave on the point of breaking. A comber has a thin line of white water on its crest, known as "feathering."

COMPANIONWAY - The steps or ladder leading downward from a deck.

COMPARTMENTS - Rooms divided by bulkheads.

COUNTER - The overhang at the stern of a boat.

CRADLE - A framework, generally made of wood, used to support a boat when it is out of the water.

CREST - The top of a wave, breaker or swell.

CUDDY - A small sheltered cabin in a boat.

CURRENT -1. The movement of water, 2. The flow of electrical charge

DEAD AHEAD - Directly in front of the boat.

DEAD RECKONING - A plot of courses steered and distances traveled through the water.

DECK - A permanent covering over a compartment, hull or any part thereof.

DINGHY - A small, open boat used for ship to shore transportation.

DISPLACEMENT - The weight of water displaced by the hull of a vessel.

DISPLACEMENT HULL - A hull that "displaces" a volume of water equal to the weight of the boat. A hull designed to run in the water rather than on top of the water. When a displacement hull moves through the water, it pushes that water out of the way. Water will then flow around the hull and fill the "hole" the boat leaves astern.

DOCUMENTED VESSEL - Documented yachts have been specially registered with the U.S. Coast Guard. All documented yachts must have their name and home (hailing) port marked on some conspicuous place on the hull. Numbering is not required. Advantages include legal authority to fly the yacht ensign, privilege of recording bills of sale, and other instruments of



title with federal officials, and preferred status for mortgages. Documentation does not exempt the unit from any State or Federal taxes. All safety and equipment regulations still apply.

DOLPHIN - A group of piles driven close together and bound with wire cables into a single structure.

DRAFT - 1. The depth of a boat from the actual water line to the bottom of the lowest part of the boat (e.g., the propeller tip or rudder). 2. The depth of water necessary to float a boat.

DROGUE - Any device streamed astern to check a vessel's speed, or to keep its stern up to the waves in a following sea.

DYE MARKER - A brightly colored chemical that spreads when released into water; normally used to attract attention.

EBB TIDE - A receding tide.

EVEN KEEL - To be floating evenly without listing to either side.

EXHAUST SYSTEM - The means by which the hot engine (or generator) exhaust gases are moved from the engine to an outboard port and then released into atmosphere.

EYE SPLICE - A permanent loop spliced in the end of a line.

FAST - Said of an object that is secured to another.

FATHOM - Six feet.

FENDER - A device (usually constructed of rubber or plastic) positioned so as to absorb the impact between vessels or dock.

FETCH - The unobstructed distance that the wind can blow over the water to create waves.

FLARE - 1. Outboard curve of the hull as it comes up the side from the waterline; the reverse of tumble home. 2. A pyrotechnic device used for emergency signaling.

FLAT - A small deck that is built below decks, specifically to support a piece of equipment.

FLEMISH - To coil down a line or rope on deck in a flat, circular, concentric arrangement.

FLOTSAM - Floating wreckage, trash or debris.

FLUKE - The palm of an anchor.

FOAM CREST - The top of the foaming water that speeds toward the beach after a wave has broken, commonly referred to as "white water."

FOLLOWING SEA - A sea (waves) moving in the same direction as a vessel.

FORE-AND-AFT - A line, or anything else, that runs parallel to the longitudinal center line of a boat.

FOREFOOT - The portion of a vessel's keel that curves upward to meet the stem.

FOREPEAK - A compartment in the bow of a boat.

FORWARD - Toward the bow.

FREEBOARD - The minimum vertical distance from the surface of the water to the gunwale.

FREQUENCY - The number of crests passing a fixed point at a given time.

FRONTS - Where opposing warm and cold air masses meet, generally producing a band of wet, stormy weather wherever they meet.

GALLEY - The kitchen area of a boat.

GALVANIC CORROSION - A potential electrical difference exists between dissimilar metals immersed in a conductive solution (e.g., salt water). If these metals touch or are otherwise electrically connected, this potential difference produces an electron flow between them. The attack on the less corrosion resistant metal is usually increased and the attack on the more resistant metal is decreased, as compared to when these metals are not touching.



GANGWAY - The area of a ship's side where people board and disembark.

GASKET - A strip of sealing material, usually rubber, set along the edge of a water or gas tight door, port, cover or hatch.

GELCOAT - The thin outer layer of pigmented plastic covering a fiberglass vessel.

GLAND - The movable part of a stuffing box, which when tightened, compresses the packing.

GROUND - Electrical term meaning the electrical potential of the earth's surface, which is zero.

GROUND SPEED - A vessel's speed made good over the earth's surface along a course or track.

GROUND TACKLE - The anchor, anchor rodes, and other fittings that are used to secure a vessel at anchor or dockside.

GUNWALE - 1. The line where the upper deck and the hull meet.
2. The upper edge of a boat's side.

HALYARD - A line used to hoist a flag or pennant.

HATCHES - Cover on hatchways.

HATCHWAYS - Access ways through decks.

HARDTOP - A permanent cover over the cabin or cockpit.

HAWSER - A heavy rope or cable used for mooring or towing.

HEAD - A toilet or lavatory area.

HEADING - The direction that a vessel is going with reference to true, magnetic, or compass north.

HEADWAY - The forward motion of a vessel through the water.

HEAVE TO - To bring a vessel up in a position where it will maintain little or no headway, usually with the bow into the wind.

HEAVY WEATHER - Stormy weather with high seas and strong winds.

HEEL - To tip to one side.

HELM - The wheel or tiller that manually controls the boat's steering system.

HELMSMAN - The individual steering the vessel.

HIGHS - A center of pressure surrounded by lower pressure on all sides. Caused by a mass of cooler, sinking, drier air. This raises the area ground level air pressure and provides clear skies.

HULL - The main body of a boat.

INBOARD - 1. From either the port or starboard side of a boat toward the fore-and-aft centerline of a boat. 2. The dock side of a moored boat.

INLAND RULES - Nautical "Rules-of-the-Road" that apply in U.S. lakes, rivers, and coastal waters.

INTERNATIONAL RULES - Nautical "Rules-of-the-Road" that are in effect by international agreement to the high seas.

ISOBARS - Lines of equal air pressure that connect all the local points on a weather map. These lines are usually closed and define high or low pressure air masses.

ISOTHERMS - Isotherms are lines that are similar to isobars except that isotherms connect all the points that are of equal temperature.

JETSAM - Refuse that sinks when discharged overboard.

KEDGE(S) - One or more anchors set out from a grounded vessel, usually astern, to 1) keep it from being driven further aground and 2) to aid in refloating.

KEEL - 1. The centerline of a boat hull bottom running fore and aft, 2. The backbone of a vessel.



KNOT - 1. A maritime unit of speed equal to one nautical mile per hour (6076 feet). 2. A term for hitches and bends.

LANYARD - A short line made fast to an object to secure it.

LATITUDE - The measure of angular distance in degrees, minutes, and seconds, north or south of the equator.

LAZARETTE - Storage compartment in the deck at the stern.

LEADLINE - A weighted line used to take depth measurements.

LEE - The direction opposite that of the wind.

LEEWARD - Away from the wind.

LIST - A vessel that inclines to port or starboard.

LORAN - Long Range Navigation. An electronic system whereby a navigator can determine position regardless of weather.

LONGITUDINAL - Running lengthwise.

LOWS - A region of low atmospheric pressure. Hurricanes are extremely concentrated low pressure systems.

LUBBER LINE - A mark or line on the compass parallel to the keel indicating forward.

MAST - A spar that is set upright to support lighting, rigging, or sails.

MOORING - An arrangement for securing a boat to a mooring buoy or pier.

NAVIGATION LIGHTS - A set of red and green or white lights which must be shown by all vessels between dusk and dawn.

OVERHEAD - A ceiling or roof of a vessel.

OVERBOARD - Over the side of the boat.

OUTBOARD - 1. From the fore-and-aft centerline of a boat toward both the port and starboard sides. 2. The seaward side of a moored boat.

3. An engine that is mounted externally onto the transom of a boat.

PAINTER - A line to the bow of a small boat used for making fast.

PASSAGEWAY - A corridor or hallway aboard ship.

PENNANT - The line by which a boat is made fast to a mooring buoy; also pendant.

PERSONAL FLOATATION DEVICE (PFD) - A life preserver.

PIER - A loading platform that extends at an angle from the shore.

PILASTER - A rectangular structural support column that is an extension of the port and starboard aft cabin sides and which supports the hardtop and flybridge.

PILING - Support, or protection for wharves, piers, etc.

PITCH - 1. The vertical (up and down) motion of a bow in a seaway, about the athwartships axis. 2. The axial advance of a propeller during one complete revolution.

PITCHPOLING - A boat being thrown end-over-end.

PLANING HULL - At slow speeds, a planing hull will displace water in the same manner as a displacement hull. As speed is increased, the hull provides a lifting effect up onto the surface of the water.

POINT - One of 32 points of the compass that is equal to 11-1/4 degrees.

PORT - 1. Looking forward, the left side of a boat, 2. A harbor, 3. An opening for light or ventilation or passage of material in the side of a boat.

PORT BEAM - The left-center of a boat.

PORT BOW - Facing the bow, the front left side.



PORT QUARTER - Looking forward, a vessel's left rear section.

QUARTER - The sides of a boat aft of amidships.

QUARTERING SEA - Sea coming on a boat's quarter.

RED-RIGHT-RETURNING - A term for helmsmen that buoys and day marker are on the right when returning from seaward.

REEF - A shallow underwater barrier

REEVE - To pass a line through a block or other opening

RIDGES - High pressure fingers extending out from a high.

RODE - The anchor line or chain.

RUNNING LIGHTS - Lights required to be shown on boats underway between sundown and sunup.

RUDDER - A vertical plate for steering a boat.

SALON - The main social cabin on a vessel, usually the largest area, occasionally referred to as the deckhouse.

SCREW - A propeller.

SCUPPER - A drain from the edge of a deck that discharges overboard.

SEACOCK - A positive action shut-off valve connected directly to the hull seawater intake and discharge piping.

SERIES - A group of waves which seem to travel together and at about the same speed.

SHACKLE - A "U" shaped connector with a pin or bolt across the open end.

SHAFT - The long, round member that connects the engine or transmission to the propeller.

SHAFT LOG - A fitting at the hull bottom where the shaft connecting an engine to its propeller penetrates the hull. A shaft log permits the shaft

to rotate while simultaneously preventing water from entering the hull.

SHEER - The top of the hull's curvature at the deck line from the bow to the stern.

SHEER STRAKE - The upper edge of the hull, immediately below the deck.

SHEET BEND - A knot used to join tow ropes.

SHOAL - An area of shallow water.

SILENCER - A baffled chamber installed in an exhaust system to reduce the noise.

SOLE - Term for deck, cabin or cockpit floor

SPAR - A general term for booms, masts, yards etc.

SPRING LINE - A pivot line used in docking, undocking, or to prevent the boat from moving forward or astern while made fast to a dock.

STARBOARD - Looking forward, the right side of a boat

STARBOARD BEAM - The right-center of a boat.

STARBOARD BOW - When facing the bow, the front right side.

STARBOARD QUARTER - When looking forward, the right rear section of the boat.

STEERAGEWAY - The lowest speed at which a vessel can be controlled by the steering wheel.

STEM - The leading edge of a boat's hull.

STERN - The back of a boat.

STRINGER - A fore and aft continuous member used to provide a vessel longitudinal strength.

STRUT - A propeller shaft support that is below the hull.

SUMP - A pit or well into which water is drained.

SUPERSTRUCTURE - Deck houses and other structures extending above the deck.



THWART - A seat or brace running laterally across a boat.

THWARTSHIPS - At right angles to the centerline.

TILLER - A bar or handle for turning a boat's rudder, or motor.

TOPSIDE - To go up to the top deck.

TRANSOM - The stern cross-section of a square sterned boat.

TRANSVERSE - Across the vessel; athwartships.

TRIM - Fore and aft balance of a boat.

TROUGH - 1. The valley that exists between waves. 2. A trough is the opposite of a ridge in that it is an elongated low-pressure area extending out from a low. A trough normally indicates unsettled weather.

TUMBLE HOME - The opposite of flare. The shape of the hull as it moves outboard going down from the gunwale to the waterline or chine.

UNDERWAY - Movement. Usually referring to a vessel proceeding forward.

V-BOTTOM - A hull with the bottom section in the shape of a "V."

V DRIVE - A drive system that has the output of the engine facing forward and coupled to a transmission. The prop shaft is then coupled to the transmission.

WAKE - Moving waves, track or path that a boat leaves behind it when moving across the water.

WATER LINE - The line of the water on the hull when the vessel is afloat.

WATCH - A 4 hour duty period while at sea.

WAVES - Waves are periodic disturbances of the sea's surface, caused by wind, seaquakes, and the gravitational pull of the moon and the sun.

WAVE GRADIENT - A wave's slope or angle from trough to crest with respect to the horizon.

WAVE HEIGHT - From the bottom of a wave's trough to the top of the crest.

WEATHER DECK - A deck with no overhead protection.

WET EXHAUST - This term refers to an exhaust system where the cooling seawater is mixed with the exhaust gases just after the riser. This mixture is then ejected through the drive or ports located in the transom or hull sides.

WHARF - A man-made structure bounding the edge of a dock and built along the shoreline.

WHIPPING - The act of wrapping the end of a piece of rope with small line, tape or plastic to prevent it from fraying.

WINDLASS - A device used to raise and lower the anchor.

WINDWARD - Toward the direction from which the wind is coming.

YAW - 1. To swing off course, as when due to the impact of a following or quartering sea. 2. Any motion about a vertical axis.



SERVICE INFORMATION

BOAT MODEL	
HULL IDENTIFICATION NUMBER	
ENGINE MODEL	
ENGINE SERIAL NUMBER	
DRIVE MODEL	
DRIVE SERIAL NUMBER	
PROPELLER DIAMETER	
PROPELLER PITCH	
PROPELLER PART NUMBER	
OIL FILTER NUMBER	
BOAT COLOR	
COCKPIT UPHOLSTERY COLOR	
CABIN UPHOLSTERY COLOR	
FUEL CAPACITY	
FUEL: ESTIMATED AVG. GALLON/HR US-AGE	
IGNITION KEY NUMBER	
GLOVE BOX KEY NUMBER	
COMPANIONWAY KEY NUMBER	
TRAILER MODEL	
TRAILER COLOR	
TRAILER SERIAL NUMBER	
TRAILER TIRE SIZE & MANUFACTURER	
SELLING DEALER	
CITY AND STATE	
PHONE NUMBER	
MISC.	

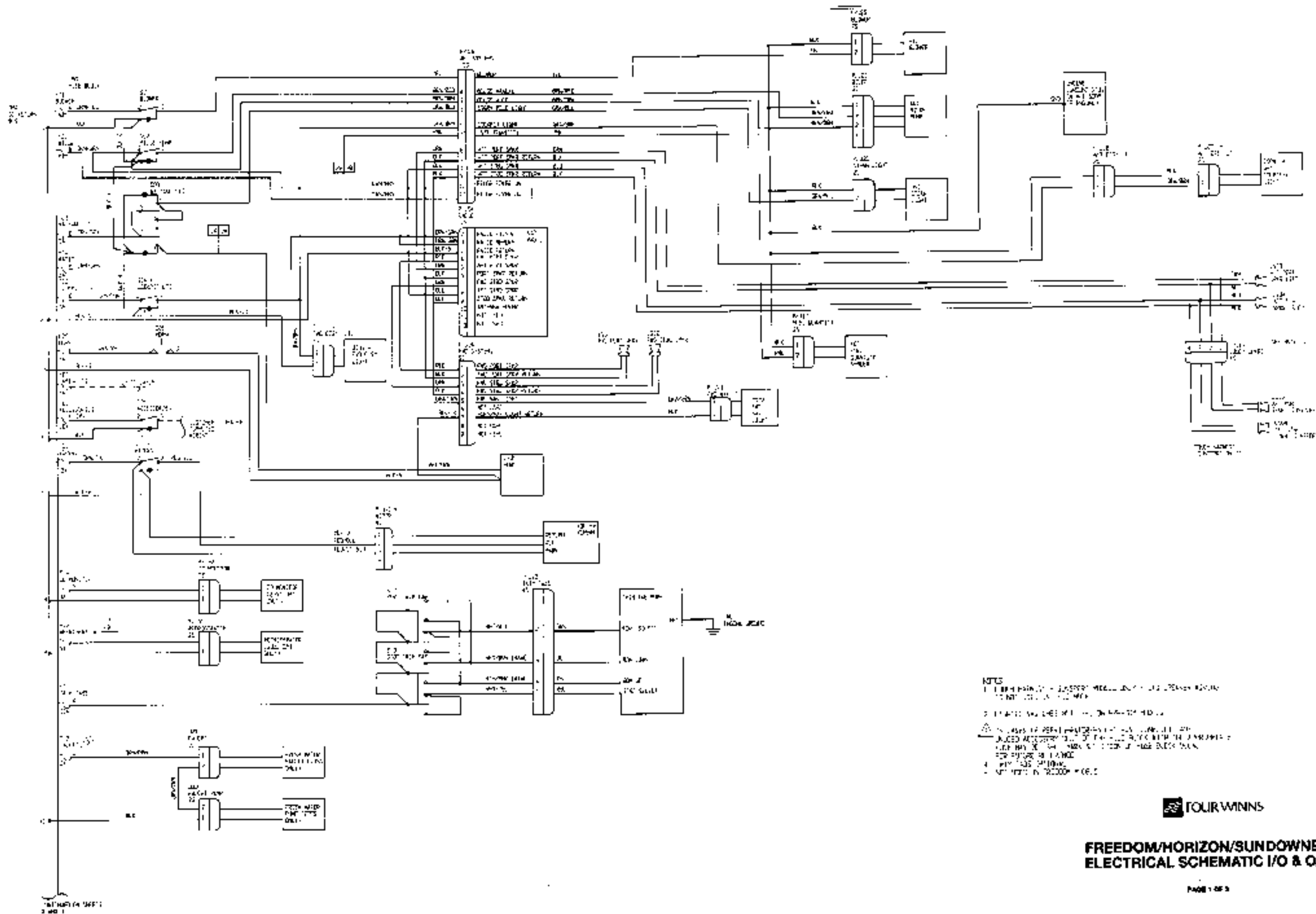

**FREEDOM/HORIZON/SUNDOWNER
ELECTRICAL SCHEMATIC I/O & O/B**

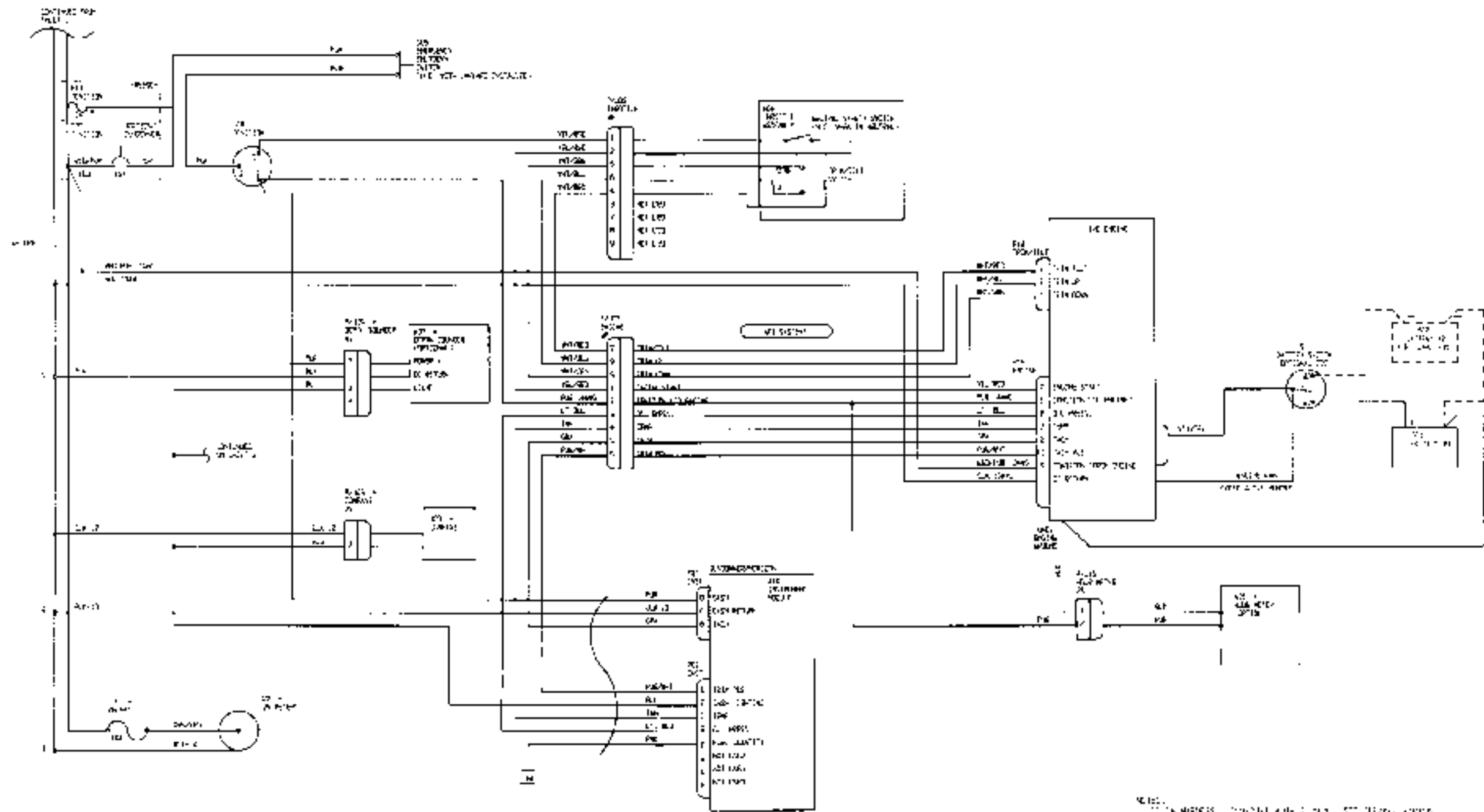

- NOTE:
1. WIRING CONNECTIONS MUST BE MADE TO THE CORRECT WIRING POINTS AND IN THE CORRECT ORDER.
 2. LOCKED SWITCHES ARE USED TO PREVENT SHORTS.
 3. IN CASE OF A SHORT CIRCUIT, ALL CIRCUITS WILL BE TRIPPED. ALL CIRCUITS WILL BE TRIPPED WITH THE APPROPRIATE FUSE. THE FUSE SHOULD BE REPLACED WITH THE SAME RATING AS THE ORIGINAL FUSE.
 4. WITH THIS SYSTEM.
 5. NOT USED IN THIS MODEL.

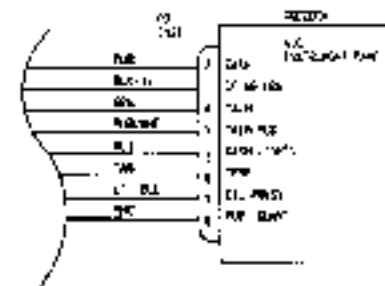

55 TOUR WINNS

**FREEDOM/HORIZON/SUNDOWNER
ELECTRICAL SCHEMATIC I/O ONLY**



FOUR WINNS

