

# V475

 **FOUR WINNS**

090-3054

V475 OWNERS MANUAL



<https://www.boat-manuals.com/>



## WARNING

A wide variety of components used on this vessel contain or emit chemicals known to the State of California to cause cancer and birth defects and other reproductive harm.

### EXAMPLES INCLUDE:

- Engine and generator exhaust
- Engine and generator fuel, and other liquids such as coolants and oil, especially used motor oil
- Cooking fuels
- Cleaners, paints, and substances used for vessel repair
- Waste materials that result from wear of vessel components
- Lead from battery terminals and from other sources such as ballast or fishing sinkers

### TO AVOID HARM:

- Keep away from engine, generator, and cooking fuel exhaust fumes
- Wash areas thoroughly with soap and water after handling the substances above

GM2203301

<b>PREFACE</b> .....	9
<b>SAFETY MESSAGES</b> .....	10
<b>OPERATION</b> .....	16
A - 1 GENERAL .....	16
A - 2 COMPONENT SYSTEMS .....	16
A - 3 SAFETY EQUIPMENT .....	16
A - 4 PASSENGER SAFETY .....	16
A - 5 RULES OF THE ROAD .....	16
A - 6 LIGHTNING .....	17
A - 7 DRUGS AND ALCOHOL .....	17
A - 8 PRE-CRUISE SYSTEM CHECK .....	17
A. Before Starting the Engines .....	17
B. After Starting the Engine .....	18
A - 9 ENGINE OPERATIONAL PROCEDURES .....	18
A. Before Starting .....	18
B. Starting Procedures .....	18
C. Shifting and Control Speed .....	19
D. Stopping Engine .....	20
E. After Stopping Engine .....	21
A - 10 GROUNDING AND TOWING .....	21
A - 11 BOATING EDUCATION .....	21
A. Boating Courses .....	21
B. Boating Manuals or Literature .....	22
C. Charts and Maps .....	22
D. Laws and Regulations .....	22
A - 12 BOAT OWNER REGISTRATION .....	22
A - 13 ACCIDENT REPORTING .....	23
A - 14 DISCHARGE OF OIL .....	23
A - 15 DISPOSAL OF PLASTICS & OTHER GARBAGE .....	23
A - 16 MARPOL TREATY .....	23
<b>BOATING SAFETY</b> .....	25
B - 1 GENERAL .....	25
A. Required Safety Equipment .....	25
B. Personal Flotation Devices (PFD's) .....	25
C. PFD Types .....	25
D. PFD Pointers .....	26
E. Fire Extinguisher .....	26
F. Fire Extinguisher System .....	27
G. Visual Distress Signal Devices .....	27
H. Sound Signaling Devices .....	27
I. Navigation Lights .....	28
J. Additional Recommended Equipment .....	28
B - 2 CARBON MONOXIDE .....	28
A. Properties and Characteristics of Carbon Monoxide .....	29
B. What Makes Carbon Monoxide .....	29
C. How a Person is Affected by Carbon Monoxide .....	29
D. Effects of Carbon Monoxide .....	29
E. Symptoms .....	29
F. Treatment (Evaluate, Ventilate, Evacuate, Investigate, Take Corrective Action) .....	30

G. Inspection.....	30
H. Operation .....	30
I. Boathouses, Sea Walls and Confined Spaces .....	30
J. The Effect of Boats Moored Along Side.....	31
K. Backdrafting (Station Wagon Effect).....	31
L. Accumulation of Exhaust Gases-Swim Platform.....	32
M. Dangerous Activity - “Teak Surfing”/“Dragging” .....	32
N. Cabin Appliances .....	32
O. Air Conditioning.....	32
P. Ventilation of Accommodation (Occupied) Spaces .....	32
Q. Running of Engines in Idle.....	32
R. Altitude and Sea Conditions .....	32
S. Portable Generator Sets.....	33
T. Maintenance - Engine Performance .....	33
U. Maintenance - External Conditions.....	33
V. Maintenance - Exhaust System Integrity .....	33
W. Maintenance - Ventilation Systems .....	34
X. Maintenance - Bulkhead and Deck Integrity .....	34
Y. Maintenance - Air Conditioning Systems .....	34
Z. Maintenance - Liquid Drains.....	34
AA. Carbon Monoxide Detection Systems .....	34
<b>B - 3 SAFE BOATING PRACTICES.....</b>	<b>35</b>
A. Drugs and Alcohol.....	35
B. Safe Operation .....	35
C. Passenger Safety.....	35
D. Propeller.....	36
E. First Aid.....	36
F. Operation By Minors .....	36
G. “Rules of the Road” .....	36
H. Voluntary Inspections .....	36
I. Safe Boating Courses .....	36
J. Anchoring.....	36
<b>B - 4 WATER SPORTS.....</b>	<b>38</b>
A. Water Sport Guidelines .....	38
B. Water Skiing/Wakeboarding/Kneeboarding.....	38
<b>BASIC SEAMANSHIP .....</b>	<b>40</b>
<b>C - 1 GENERAL.....</b>	<b>40</b>
A. Boating Regulations .....	40
B. Rules of Seamanship .....	40
<b>C - 2 NAVIGATIONAL AIDS .....</b>	<b>42</b>
A. International Association of Lighthouse Authorities System B (IALA-B) .....	42
B. Lateral Markers .....	42
C. Safe Water Markers .....	42
D. The Uniform State Waterway Marking System .....	43
E. A Special Sign.....	43
F. Noise.....	43
<b>C - 3 RECOMMENDED READING .....</b>	<b>43</b>
<b>C - 4 CONTACTS .....</b>	<b>43</b>
<b>C - 5 OWNER’S LOGS AND RECORDS .....</b>	<b>44</b>
<b>C - 6 NAVIGATIONAL AIDS CHART .....</b>	<b>44</b>



<b>WARRANTY AND SERVICE</b> .....	45
D - 1    FOUR WINNS WARRANTY POLICY .....	45
D - 2    DECK/HULL STRUCTURE WARRANTY .....	45
D - 3    WARRANTY REGISTRATION .....	45
D - 4    TRANSFER OF WARRANTY .....	45
D - 5    PRE-OWNED UNIT REGISTRATION .....	45
D - 6    INSURANCE COVERAGE .....	46
D - 7    SERIAL NUMBER RECORD.....	46
D - 8    PRE-DELIVERY SERVICE.....	46
D - 9    REPLACEMENT PARTS.....	46
D - 10   OWNER'S RESPONSIBILITIES.....	46
D - 11   CONSTRUCTION STANDARDS.....	47
D - 12   WINNGEAR.....	47
NAME/ADDRESS CHANGE FORM .....	48
WARRANTY REGISTRATION TRANSFER REQUEST .....	50
 <b>ENGINES, DRIVES AND INSTRUMENTATION</b> .....	 52
E - 1    GENERAL .....	52
E - 2    ENGINE EXHAUST.....	52
A    Carbon Monoxide.....	52
B    Carbon Monoxide Monitor .....	53
E - 3    ENGINES & DRIVE SYSTEM .....	53
A    Engine.....	53
B    Volvo Penta IPS Drive - Units.....	54
E - 4    PROPELLERS .....	54
A    Diameter .....	54
B    Pitch.....	54
C    Prop Slip .....	55
E - 5    COOLING SYSTEMS.....	55
A    Fresh Water Cooling System .....	55
B    Sea Water Cooling System .....	55
E - 6    RUNNING ANGLE & TRIM TABS .....	56
A    Trim Tabs Control Operation .....	56
B    Control Listing .....	57
C    Induce Planning & Controlling Trim Angle .....	57
D    Trim Tab Maintenance .....	58
E - 7    ENGINE INSTRUMENTATION .....	58
A    EVC System Display .....	58
B    EVC Control Panel .....	60
C    Engine Hour Meter .....	61
D    Ignition Switch .....	61
E    Alarm System .....	61
F    Navigational Equipment .....	61
G    Instrument Maintenance .....	63
 <b>CONTROL SYSTEMS</b> .....	 64
F - 1    GENERAL .....	64
F - 2    CONTROL OPERATION.....	64
A    General.....	64
B    Shifting and Control Speed .....	64
C    Engine Speed Synchronization .....	65

F - 3	NEUTRAL SAFETY SWITCH.....	66
F - 4	JOYSTICK CONTROL .....	66
F - 5	CONTROL SYSTEM MAINTENANCE .....	66
<b>STEERING SYSTEMS.....</b>		<b>67</b>
G - 1	GENERAL .....	67
	A. Tilt Steering.....	67
G - 2	STEERING LOAD .....	67
G - 3	PROPELLER TORQUE .....	68
G - 4	STEERING SYSTEM MAINTENANCE.....	68
<b>ELECTRICAL SYSTEMS .....</b>		<b>69</b>
H - 1	GENERAL .....	69
H - 2	CIRCUIT BREAKER PANELS.....	69
H - 3	BATTERY CHARGER .....	72
H - 4	SYSTEM VOLTAGE .....	72
H - 5	12 VOLT ELECTRICAL EQUIPMENT .....	73
	A. Helm Equipment.....	73
	B. Installation of Additional 12 Volt Equipment .....	75
	C. Interior/Exterior Equipment .....	75
H - 6	12 VOLT ELECTRICAL SYSTEM SHUTDOWN PROCEDURES.....	77
H - 7	240/120 (230V 50Hz) VOLT ELECTRICAL SYSTEM.....	77
H - 8	DOCKSIDE OPERATION .....	79
	A. Shore Power Connections .....	79
	B. 120 Volt AC Equipment .....	80
	C. Ground Fault Current Interrupters (GFCI).....	81
H - 9	GENERATOR .....	82
H - 10	ELECTRICAL SYSTEM MAINTENANCE .....	83
	A. Battery Maintenance .....	83
	B. Electrical Wiring Maintenance .....	84
H - 11	STRAY CURRENT CORROSION .....	85
	A. General .....	85
	B. Galvanic Corrosion .....	85
	C. Corrosion Prevention .....	85
<b>FUEL SYSTEMS .....</b>		<b>86</b>
I - 1	DIESEL FUEL SYSTEMS.....	86
	A. System Testing .....	86
	B. Fuel Fills.....	87
	C. Fuel Vents.....	87
	D. Fuel Pickup .....	88
	E. Fuel Level .....	88
	F. Fuel Senders .....	88
	G. Fuel Filters .....	89
	H. Use and Maintenance .....	89
I - 2	FUEL INSTRUCTIONS.....	89
<b>WATER AND WASTE SYSTEMS .....</b>		<b>93</b>
J - 1	GENERAL .....	93
J - 2	PRESSURIZED WATER SYSTEM.....	94

	A. Priming the System .....	94
	B. System Operation .....	95
	C. Water Heating Systems.....	95
	D. Using The Forward and Aft Showers .....	95
J - 3	GRAY WATER SYSTEM OPTION .....	96
J - 4	SHORE WATER CONNECTION .....	96
J - 5	TRANSOM SHOWER .....	97
J - 6	BOW WASHDOWN .....	97
J - 7	WASTE SYSTEM.....	98
	A. Sanitation System .....	98
	B. Head with Overboard Discharge .....	99
	C. Dockside Waste Pump Out .....	101
J - 8	SYSTEM MAINTENANCE.....	101
	A. Clean Vents and Screens.....	101
	B. Winterizing the Water System .....	102
	C. Winterizing the Waste System .....	103
<b>VENTILATION AND DRAINAGE SYSTEMS .....</b>		<b>104</b>
K - 1	ENGINE COMPARTMENT VENTILATION.....	104
	A. Natural Ventilation System .....	104
	B. Forced Air Ventilation .....	104
	C. Engine Ventilation System Maintenance .....	104
K - 2	CABIN AND COCKPIT VENTILATION .....	104
K - 3	HULL DRAINAGE SYSTEM .....	106
	A. Transom Drain .....	106
	B. Bilge Pumps .....	106
	C. Sump .....	106
	D. Bilge Compartment Drainage .....	106
	E. Cockpit Drainage .....	107
<b>INTERIOR EQUIPMENT.....</b>		<b>108</b>
L - 1	GALLEY EQUIPMENT .....	108
	A. Electric Stove .....	108
	B. Galley Sink.....	108
	C. Microwave Oven .....	108
	D. Galley Refrigerator/Freezer .....	108
L - 2	COCKPIT REFRESHMENT CENTER.....	109
L - 3	COCKPIT STORAGE .....	110
L - 4	ENTERTAINMENT .....	110
	A. Stereo System - Helm and Transom .....	110
	B. Bose Lifestyle® 35 System .....	111
	C. Flatscreen Televisions with Remotes .....	112
	D. Cockpit TV Options .....	113
	E. Satellite TV System Option.....	113
L - 5	CENTRAL VACUUM .....	114
L - 6	WASHER/DRYER OPTION .....	114
L - 7	AIR CONDITIONING .....	114
L - 8	CARBON MONOXIDE DETECTORS .....	116

<b>EXTERIOR EQUIPMENT .....</b>	<b>119</b>
M - 1 RAILS & DECK HARDWARE .....	119
M - 2 TRANSOM DOOR.....	119
M - 3 COMPANIONWAY DOOR.....	120
M - 4 WINDOWS .....	120
A. Windshield .....	120
B. Cabin/Cockpit Windows .....	121
M - 5 FOREDECK HATCH .....	121
M - 6 EXTENDED SWIM PLATFORM.....	122
M - 7 SWIM PLATFORM LIFT OPTION .....	123
M - 8 TRANSOM STORAGE LOCKER .....	123
M - 9 ELECTRIC GRILL .....	123
M - 10 TRANSOM TABLE OPTION .....	123
M - 11 BOW PLATFORM .....	124
M - 12 WINDLASS.....	124
M - 13 SEARCH LIGHT .....	125
M - 14 UNDERWATER LIGHTING OPTION .....	125
M - 15 HARD TOP.....	125
M - 16 ENGINE HATCH WITH ELECTRIC LIFT.....	125
M - 17 FLAG POLE AND HOLDER OPTION.....	126
 <b>UPHOLSTERY .....</b>	 <b>127</b>
N - 1 INTERIOR FURNISHINGS.....	127
A. Couch and Dinette Table.....	127
B. Master Stateroom.....	127
C. Mid Cabin Stateroom .....	128
N - 2 EXTERIOR FURNISHINGS.....	129
A. Helm Seat .....	129
B. Stern Seat .....	130
C. Cockpit Table .....	130
D. Port Lounge .....	131
E. Deck Sunpads.....	132
N - 3 INTERIOR UPHOLSTERY CARE .....	132
A. Cleaning Interior Fabric/Upholstery .....	132
B. Interior Carpets .....	133
C. Privacy Curtains.....	133
N - 4 EXTERIOR UPHOLSTERY CARE .....	133
A. Cleaning Vinyl .....	133
B. Exterior Carpets .....	135
C. Cleaning and Maintenance.....	135
D. Stain Removal Testing .....	135
E. Stain Removal Procedures.....	136
N - 5 REPLACEMENT UPHOLSTERY .....	136
 <b>WEATHER COVERS.....</b>	 <b>137</b>
O - 1 GENERAL INFORMATION .....	137
O - 2 GENERAL CANVAS INSTALLATION GUIDE LINES .....	137
O - 3 CANVAS INSTALLATION .....	138
O - 4 USE OF WEATHER COVERS AND CARBON MONOXIDE .....	140
O - 5 WINTER STORAGE.....	141
O - 6 MAINTENANCE .....	141



<b>FIBERGLASS AND HULL</b> .....	142
P - 1 HULL DESIGN INFORMATION.....	142
P - 2 FIBERGLASS CONSTRUCTION .....	142
P - 3 EQUIPMENT INSTALLATION.....	142
P - 4 FIBERGLASS CARE & MAINTENANCE .....	142
A. General Maintenance .....	142
B. Weathering Effects on Gel Coat .....	143
C. Stains.....	144
P - 5 FIBERGLASS REPAIRS .....	144
A. Scratches .....	144
B. Gouges & Cracks .....	145
C. Osmotic Blistering .....	145
P - 6 ANTI-FOULING PAINT.....	146
P - 7 HULL SUPPORT .....	146
 <b>WOODWORK AND COMPOSITES</b> .....	 148
Q - 1 HIGH-PRESSURE LAMINATE CARE .....	148
Q - 2 REAL WOOD TRIM.....	148
Q - 3 STAR BOARD .....	148
Q - 4 LAMINATED FIBERGLASS.....	148
Q - 5 TEAK.....	148
Q - 6 SOLID SURFACE MATERIAL.....	149
Q - 7 ACRYLIC PLASTIC - (PLEXIGLASS).....	150
Q - 8 FLEXITEEK.....	151
 <b>GENERAL MAINTENANCE</b> .....	 152
R - 1 WINTERIZATION .....	152
A. Prior to Lifting for Winter Lay up .....	152
B. After Lifting.....	152
C. Prior to Winter Storage.....	153
R - 2 GENERAL MAINTENANCE SCHEDULE .....	154
 <b>PRE-LAUNCH AND UNDERWAY</b> .....	 157
S - 1 LAUNCH & CRUISE CHECKLIST .....	157
S - 2 FUELING.....	158
A. Recommendations .....	158
B. Preliminary Guidelines .....	158
C. Pumping Fuel.....	158
D. After Fueling.....	158
S - 3 LOADING PASSENGERS & GEAR .....	159
S - 4 STARTING PROCEDURES .....	159
A. Preliminary Checks .....	159
B. Starting.....	159
S - 5 MANEUVERING.....	160
A. Leaving the Dock .....	160
B. Stopping.....	160
S - 6 ACCELERATION.....	161
S - 7 TRIMMING YOUR BOAT .....	161
S - 8 NAVIGATION LIGHTS.....	162
S - 9 HAZARDOUS CONDITIONS.....	162

A. Storms .....	162
B. Fog.....	163
C. Running Aground .....	163
D. Warning Markers.....	164
S - 10 REACTING TO EMERGENCIES.....	164
A. Flooding .....	164
B. Capsizing and Man Overboard.....	164
C. Capsizing .....	164
D. Man Overboard .....	164
E. Collision .....	164
F. Fire.....	165
G. Medical Emergency.....	165
H. Propulsion Failure .....	165
I. Control Failure.....	165
J. Steering Failure.....	166
K. Additional Underway Information.....	166
S - 11 RETURNING TO SHORE.....	166
A. Docking.....	166
B. Mooring.....	167
<b>GLOSSARY.....</b>	<b>169</b>
<b>FLOAT PLAN .....</b>	<b>176</b>
<b>FUEL LOG.....</b>	<b>177</b>
<b>SERVICE LOG .....</b>	<b>180</b>
<b>SERVICE INFORMATION .....</b>	<b>183</b>
<b>V475 LOCATOR DRAWING .....</b>	<b>184</b>

Congratulations on your new boat purchase and welcome to our boating family!

We want your boating experience to be the most enjoyable possible. The more you know about your new boat, the more you'll enjoy the time you spend aboard. That's why we prepared this manual. It's your guide for safe operation as well as understanding your boat's systems and equipment. It has been written for the beginning boater but experienced boaters will find helpful information as well. Be sure to read the contents thoroughly.

This manual will acquaint you with the use and maintenance of your new Four Winns boat. This manual also provides special information critical to the safety of the passengers, and longevity of the equipment. The information on the following page lists the graphics used to increase the visibility of these important messages. Also included in your owner's packet is the "Boating Basics, A Guide to Responsible Boating". This guide covers boating basics and should be read along with your Four Winns owner's manual before operating your boat. Review this information completely before using your new boat.

Four Winns continually strives to improve its products. Unit specifications, including standard and optional equipment are constantly being modified. **Equipment availability is also subject to change without notice. The most current and accurate information available at the time of publication is included in this manual. Some variation in material, equipment, description, location, and details can result. Please refer to our website for further updated information and possible revisions to this manual.**

The information in this manual focuses upon the equipment designed and manufactured by Four Winns on specific models. When appropriate, please utilize the information pertinent to your specific boat model.

Equipment such as engines, and other accessories are manufactured by others. **The information provided in this manual is intended to be used in conjunction with the information provided by the manufacturers of this equipment.** All information available at the time of manufacture has been included with your owner's packet. In many cases, replacement of manufacturer's literature may be obtained via their respective websites.

**Read this entire manual carefully before operating your new boat.** Many instructions may require direct performance of the activity to fully understand the correct method. If you choose to read this manual at home, remember to take it to the boat with you.

Your Four Winns dealer knows your boat best and is committed to your complete satisfaction. Return to the dealer for service or other assistance. If you find it necessary to contact Four Winns directly, please refer to the contact information listed below. Be sure to include the boat model, hull identification number, your daytime telephone number, and specifics of the information desired.

This manual has been specifically developed for the V475 model. Please record the model and hull identification number information below.

Model

Hull Identification Number

---

This manual should be considered part of the boat. Should you sell the boat, pass this manual on to the new owner. Take special care of this manual. Certain information in this manual may not be available in a replacement manual. An electronic version of this manual may be viewed on our website at [www.fourwinns.com](http://www.fourwinns.com).

Thank you for joining the Four Winns family. We appreciate your purchase and welcome the opportunity to demonstrate our commitment to you.

Four Winns Customer Service Department

925 Frisbie Street

Cadillac, Michigan 49601

231 775-1343 (Phone)

231 779-2345 (Fax)

E-Mail Address: [boating@fourwinns.com](mailto:boating@fourwinns.com)

©FOUR WINNS LLC 2010. All Rights Reserved.

The popularity of boating and other water sports has grown tremendously in the past few years. Because of this, safety is an important issue for everyone who shares our waterways.

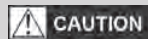
Remember that along with the freedom and exhilaration of boating comes the responsibility that you have for the safety of your passengers and the other boaters who share the water with you. Throughout this manual, specific precautions and symbols identify safety-related information. Be sure to pay close attention to them.

**IMPORTANT HEALTH AND SAFETY INFORMATION ABOUT YOUR NEW BOAT**
**NOTICE**

*Boxes that are gray require your special attention. Notice boxes include helpful boating practices and law reminders.*



*This symbol means "pay attention!" Here is important information for your safety. If you don't follow these instructions, you can damage your boat, hurt yourself or someone else or, even worse, have a fatal accident.*



*This symbol and signal word indicate a potentially hazardous situation. If you ignore this safety message, property damage or minor or moderate personal injury MAY or CAN result.*



*This symbol and signal word indicate a potential hazard. If you ignore this safety message, serious injury or death CAN result.*



*This symbol and signal word indicates an immediate hazard. If you ignore this safety message, serious personal injury or death WILL result.*

The precautions in this manual can not and do not cover every boating situation. If a specific method or procedure is not recommended, you must make sure that what you do is safe for you and others. Always use common sense when boating! Remember to make sure that every safe boating excursion is a happy experience.

**IMPORTANT HEALTH AND SAFETY INFORMATION ABOUT YOUR NEW BOAT**

WARNING

A wide variety of components used on this vessel contain or emit chemicals known to the State of California to cause cancer and birth defects and other reproductive harm.

**EXAMPLES INCLUDE:**

- Engine and generator exhaust
- Engine and generator fuel, and other liquids such as coolants and oil, especially used motor oil
- Cooking fuels
- Cleaners, paints, and substances used for vessel repair
- Waste materials that result from wear of vessel components
- Lead from battery terminals and from other sources such as ballast or fishing sinkers

**TO AVOID HARM:**

- Keep away from engine, generator, and cooking fuel exhaust fumes
- Wash areas thoroughly with soap and water after handling the substances above

0M2203391


We'd also like to remind you to be kind to our environment while you're boating. Don't throw garbage and other refuse overboard. Do your best to keep harmful compounds like gasoline, oil and antifreeze out of the water. Please see the notifications below:

### DISCHARGE OF OIL PROHIBITED

THE FEDERAL WATER POLLUTION CONTROL ACT PROHIBITS THE DISCHARGE OF OIL OR OILY WASTE INTO OR UPON THE NAVIGABLE WATERS OF THE UNITED STATES, OR THE WATERS OF THE CONTIGUOUS ZONE, OR WHICH MAY EFFECT NATURAL RESOURCES BELONGING TO, APPERTAINING TO, OR UNDER THE EXCLUSIVE MANAGEMENT AUTHORITY OF THE UNITED STATES, IF SUCH DISCHARGE CAUSES A FILM OR DISCOLORATION OF THE SURFACE OF THE WATER OR CAUSES A SLUDGE OR EMULSION BENEATH THE SURFACE OF THE WATER. VIOLATORS ARE SUBJECT TO SUBSTANTIAL CIVIL PENALTIES AND/OR CRIMINAL SANCTIONS INCLUDING FINES AND IMPRISONMENT.

*Oil Discharge Plate - (Specific Models Only - Location Not Shown)*

**It is illegal for any vessel to dump plastic trash anywhere in the ocean or navigable waters of the United States. Annex V of the MARPOL TREATY is an international law for a cleaner, safer marine environment. Violation of these requirements may result in civil penalty up to \$25,000, fine and imprisonment.**

 U.S. Lakes, Rivers, Bays, Sounds and <u>3 miles from shore</u> <b>ILLEGAL TO DUMP Plastic &amp; Garbage</b> Paper Metal Rags Crockery Glass Dunnage Food	<b>3 to 12 miles</b> <b>ILLEGAL TO DUMP Plastic</b> Dunnage, lining & packing materials that float, also if not ground to less than one inch: Paper Crockery Rags Metal Glass Food	<b>12 to 25 miles</b> <b>ILLEGAL TO DUMP Plastic</b> Dunnage, lining & packing materials that float	<b>Outside 25 miles</b> <b>ILLEGAL TO DUMP Plastic</b>
---	---	---	---

State and local regulations may further restrict the disposal of garbage.

*Trash Overboard Decal - (Specific Models Only - Location Not Shown)*

*This manual has been compiled to help you operate your boat with safety and pleasure. It contains the details of the boat, the equipment supplied or fitted, its systems, and information on its operation and maintenance. Please read it carefully and familiarize yourself with the boat before using it.*

*If this is your first boat, or if you are changing to a type of boat you are not familiar with, for your own comfort and safety, please ensure that you obtain handling and operating experience before "assuming command" of the boat. Your dealer or national sailing federation or yacht club will be pleased to advise you of local sea schools and competent instructors.*

**PLEASE KEEP THIS MANUAL IN A SECURE PLACE, AND HAND IT OVER TO THE NEW OWNER WHEN YOU SELL THE BOAT.**

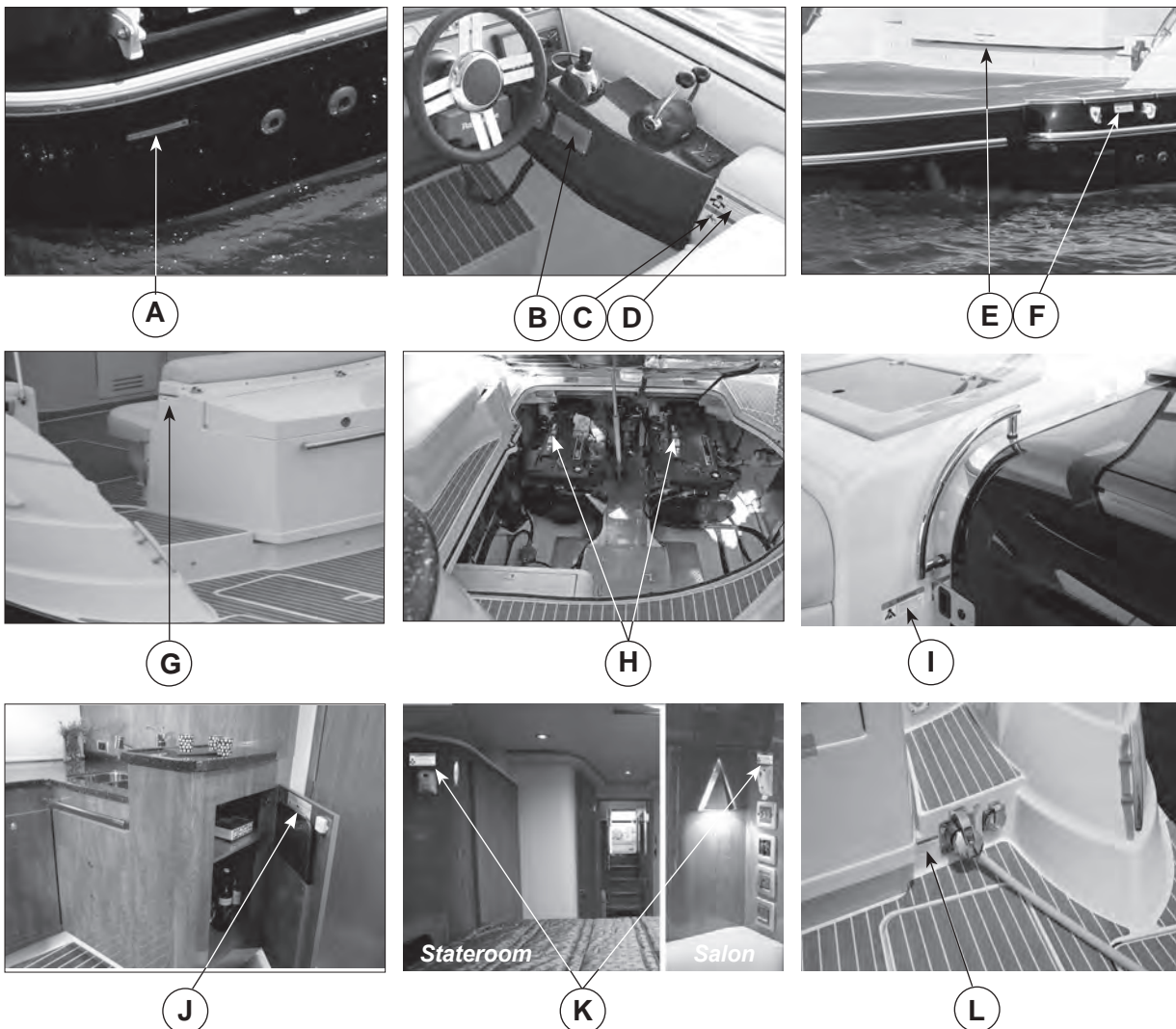


## LABEL LOCATIONS

Various warning labels are placed at different locations on each model for your safety. Additional warnings for fuel leakage, blower operation, and other important information will be imprinted or located on the dash. Many of these stickers and labels are not required by the US Coast Guard but are important to ensure the safe operation of your Four Winns® boat. In addition, the Hull Identification Number plate is permanently attached below the deck-hull joint at the stern on the starboard side.

Below are letters corresponding to the various locations for each item on the drawings. See the following pages of this section for the actual wording of each of the various warning labels found on your boat.


- |   |  |
|---|--|
| (A) Hull Identification Number Plate                    | (G) Transom Door Prevent Falls Overboard Label |
| (B) NMMA Yacht Certification Plate                      | (H) Leaking Fuel Warning Label                 |
| (C) Helm Boarding Ladder Warning                        | (I) CO - Cabin Door                            |
| (D) CO - Helm Warning Label                             | (J) Trash Overboard Discharge Decal            |
| (E) CO - Transom Warning Label                          | (K) CO - Cabin Warning Label                   |
| (F) Rotating Prop Boarding Ladder (Port & Stbd Typical) | (L) Shore Power Inlet Warning Label            |



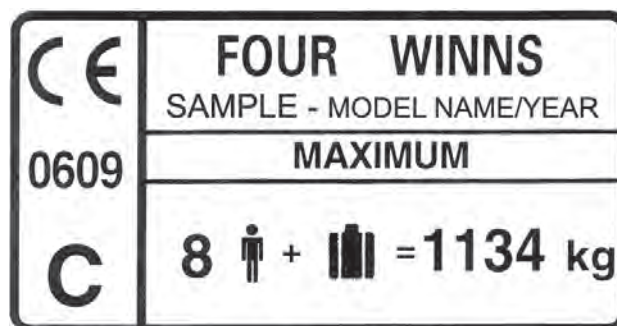
**Figure 1: Warning Labels and Other Label Locations - Reference Only**  
(Locations may vary)

**YACHT CERTIFICATION & WARNING LABELS**


*NMMA Yacht Certification Plate*

 Fisheries and Oceans / Pêches et Océans Canada / Canada Coast Guard / Garde côtière		Canada	
<b>BUILDER - CONSTRUCTEUR</b>	<b>MODEL - MODÈLE</b>		
FOUR WINNS BOATS, L.L.C.	MODEL NAME (GFN)		
THE MANUFACTURER CERTIFIES THAT THIS PRODUCT COMPLIES WITH THE CONSTRUCTION STANDARDS FOR SMALL VESSELS.	LE FABRICANT CERTIFIE QUE CE PRODUIT EST CONFORME AUX NORMES DE CONSTRUCTION DES PETITS BATEAUX.		
NO. - no POYEXXXX	<b>SAMPLE</b>		

*Canadian Conformity Label*



*EU Builders Plate - CE Certification Plate (Export)*



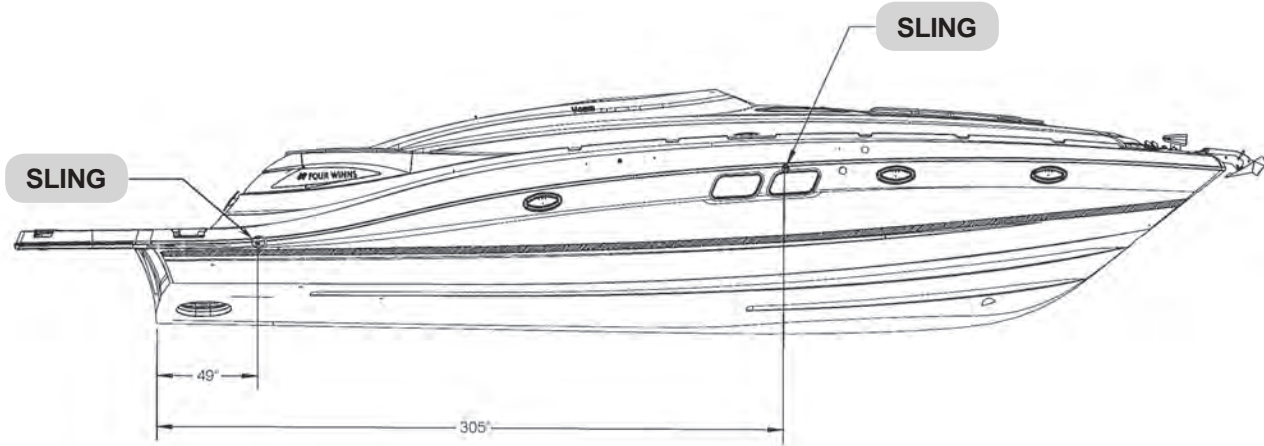
*Winning Edge Sticker*




*NMMA Certified Sticker*

**CAUTION**

Ensure slings are in proper location as indicated by the sling label location. Failure to do so may result in permanent hull structure damage and will invalidate the hull structure warranty.



**WARNING**



Fuel vapors are a fire and explosion hazard. To avoid injury or death, do not store fuel or flammable liquids here.

GM1850701

*No Ventilation - Do Not Store Fuel Warning Label*

**WARNING**



Exhaust fumes from engines contain carbon monoxide. To prevent fumes from entering cabin, keep door closed when engine or generator are running.

GM1850301


*Carbon Monoxide - Cabin Doors Warning Label*

**WARNING**

Exhaust fumes from engines contain carbon monoxide. Boats with canvas deployed are more likely to collect exhaust fumes. Avoid brain damage or death from carbon monoxide. Keep cockpit and cabin areas well ventilated. Signs of exposure include nausea, dizziness, and drowsiness. See boat owner's manual for more details. If using a catalytic heater, provide ventilation. Do not use catalytic heater while sleeping.

*Carbon Monoxide - Canvas Warning Label*

**WARNING**



To minimize shock and fire hazards:

- (1) Turn off the boat's shore connection switch before connecting or disconnecting shore cable.
- (2) Connect shore power cable at the boat first.
- (3) If polarity warning indicator is activated, immediately disconnect cable.
- (4) Disconnect shore power cable at shore outlet first.
- (5) Close shore power inlet cover tightly.

**DO NOT ALTER SHORE POWER CONNECTORS**

GM1850401

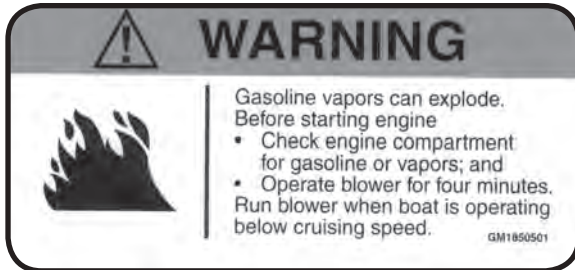
*Shore Power Inlet Warning Label*

**CAUTION**

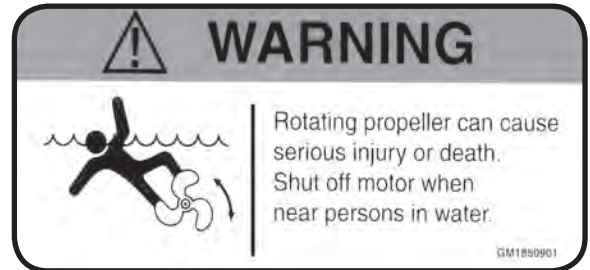
DO NOT RESTRICT AIR FLOW WHILE MICROWAVE IS IN USE, OR DAMAGE TO MICROWAVE OVEN OR CABINET MAY RESULT.

*Microwave Caution Label*

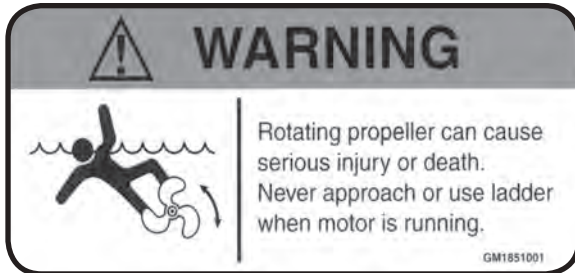




**Gasoline Vapor-Blower Warning Label**



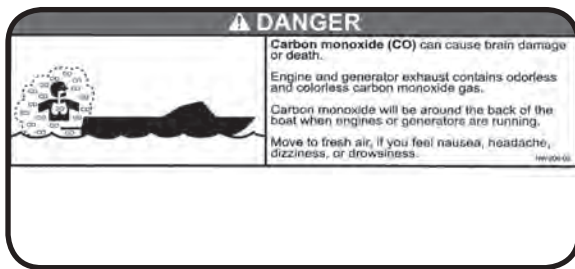
**Rotating Propeller - Helm Warning Label**



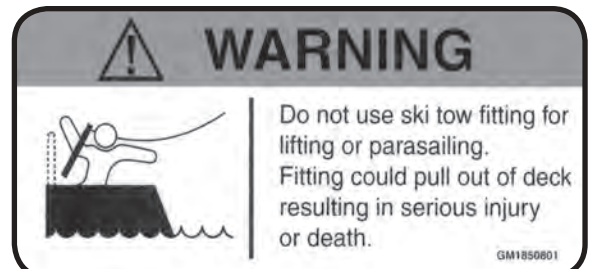
**Rotating Propeller - Ladder Warning Label**



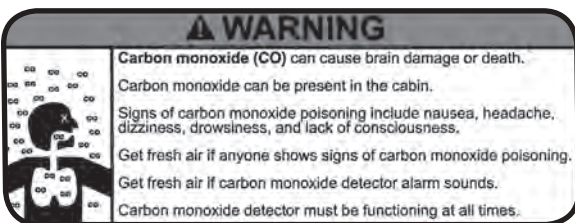
**Leaking Fuel Warning Label**



**CO Swim Platform and Lounging Area Warning Label**



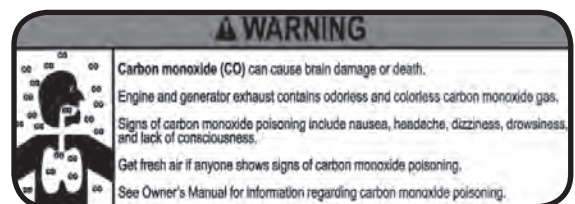
**Ski Tow Warning Label**



**CO-Cabin Warning Label**



**Transom/Side Door Warning Label**



**CO-Helm Warning Label**

## A - 1 GENERAL

Before starting the boat, become familiar with all of the various systems and related operations. Be sure all necessary safety equipment is on-board. Know the “Rules of the Road”. Have an experienced operator brief you on the general operation of your new boat. Perform a “pre-cruise systems check”. This manual is a part of your boat’s equipment. Always keep it on board.

## A - 2 COMPONENT SYSTEMS

Before you can really enjoy your boat, a thorough understanding of its systems and their operation is essential. This manual and the associated manufacturers information are included in the owner’s packet. This information is provided to enhance your knowledge of the boat. Read this information carefully.

After becoming familiar with the boat and its systems, reread this manual and other material provided in the owner’s packet. Maintenance and service tips are included to help keep the boat in like-new condition.

## A - 3 SAFETY EQUIPMENT

Besides the equipment installed on the boat by Four Winns certain other equipment is required for passenger safety. A booklet listing the Federal equipment requirements is included in the owner’s packet or is available through your local US Coast Guard Station. Remember that these laws are for your protection and are minimum requirements. Check your local and state regulations, also. More information on safety equipment is provided in Section B.

Items like a sea anchor, working anchor, extra dock lines, flare pistol, a line permanently secured to your ring buoy, etc. could at some time save your passengers lives, or save your boat from damage.

The Coast Guard Auxiliary offers a “Courtesy Examination.” This inspection will confirm the boat is equipped with all of the necessary safety equipment.

## A - 4 PASSENGER SAFETY

You are responsible for the safety of your passengers as well as for their behavior while aboard. Make sure:

1. Each passenger is properly instructed in Personal Flotation Device (PFD) use and keeps one within reach in case of emergency. All non-swimmers and children should wear a PFD at all times when underway.
2. Passengers do not sit on gunwales, open decks, elevated pedestal seats or on seat backs when the boat is underway. This could cause them to be thrown overboard during a sudden maneuver.
3. At least one other person knows how to operate the boat in case of an emergency.

## A - 5 “RULES OF THE ROAD”

As in driving an automobile, there are a few rules that must be known if safe boating operation is to be maintained. The Coast Guard, Coast Guard Auxiliary, Department of Natural Resources or your local boat club sponsor courses in boat handling, including “rules of the road”. Such courses are strongly recommended. Books on this subject are also available from local libraries.

## A - 6 LIGHTNING

When boating, it is important to be aware of the weather around you. When the weather changes for the worse, DO NOT jeopardize your safety by trying to “ride out the storm”. If possible, return to safe harbor and dock your vessel immediately.

If caught in a storm, seek shelter inside the cabin and wait for the storm to pass. With certain models, campers will provide some protection, but should not be relied on if you are able to return to shore. Exercise care when high winds are present!

### NOTICE

*Four Winns boats are **not** equipped with a lightning protection system.*





*DO NOT swim or dangle legs or arms into the water during a lightning storm. Stay out of the water!*

Lightning will seek a ground when it strikes. Avoid contact with metal parts such as bow rails, control handle, or windshield.

## A - 7 DRUGS AND ALCOHOL

Please keep in mind that along with the fun of boating comes responsibility. As the owner or operator of a pleasure boat, you are obligated (morally and legally) to use good judgement while underway in providing for the safety and well-being of your passengers and other boaters around you.

A common and flagrant violation of good judgement and the law by boaters involves the use of alcohol or drugs. Each year, about half of all accidents involving fatalities involve the use of alcohol or drugs.

It is a federal offense to operate a boat while intoxicated. Criminal penalties may include the termination of operating privileges for up to one year. Many states have passed similar laws.

Alcohol or drugs have an inhibiting effect on the judgement and reaction time of the boat operator and his/her passengers. Heed the advice of experts and statisticians...DO NOT drink or use drugs when operating a boat. NEVER allow an obviously intoxicated person to take the helm.

Have fun in your Four Winns® boat, but also have the good sense to be mentally alert and physically capable of operating the boat in a safe manner.

## A - 8 PRE-CRUISE SYSTEMS CHECK

Before leaving the dock, the following items should be checked:

### A. Before Starting The Engine

1. Check the weather forecast. Determine if the cruise planned can be made safely.

2. Be sure all necessary safety equipment is on board and operative. This includes items such as the running lights, horn, spotlight, life saving devices, etc.
3. Conduct an engine and engine room general inspection. Check the bilge water level and bilge pump operation. Check the engine oil level, coolant level and drive-unit oil level. Look for other signs of potential problems such as leaks and conduct function checks. Check for the scent of fuel fumes.
4. Activate the Bilge Blower. Check the blower output.



*Fuel vapors can explode resulting in injury or death. Before starting the engine, check engine compartment bilge for fuel or vapors. Operate blower for four minutes, and verify blower operation. ALWAYS run the blower when the vessel is operating below cruising speed.*

5. Ensure an adequate amount of fuel is on board.
6. Be sure you have sufficient water and other provisions on board for the cruise planned.
7. Leave a written message listing details of the planned cruise with a close friend ashore.

### B. After Starting The Engine

1. Visibly check the engine to be sure there are no apparent water or oil leaks.
2. Check the displays . Make sure the oil pressure, water temperature, voltmeter, etc. are reading normally.
3. Have a safe cruise and enjoy yourself.



*Always be sure to raise the anchor and ensure the chain stop is engaged prior to operating your boat. Failure to raise and secure anchor before getting underway could result in damage to boat and even severe injury or death from a rebounding anchor.*

## A - 9 ENGINE OPERATIONAL PROCEDURES

### NOTICE

*Consult engine operator's manual for specific procedure for your particular model. The following information is general in nature. Additional general information is located in Section S.*

#### A. Before Starting

1. Ensure an adequate amount of fuel is on board. Open the fuel valves.
2. Check the engine compartment for water, fuel, and/or oil leaks of any kind. Keep the bilge in a clean condition to prevent blower and bilge pump damage, and fire hazards.
3. Check the fluid levels of the engine oil and drive-unit daily before first start. Fill oil or drive-unit as required by the indications on the dip sticks. Refer to the engine operator's manual for specific requirements regarding grade and viscosity of oils.

### NOTICE

**Important!** *Use of improper or inferior oil can cause excessive wear of bearings and moving parts thus shortening the engine life. It can also result in sticking of piston rings and seizing of pistons in the cylinders, thus causing major damage.*

4. Activate the 3 batteries (Port, Stbd & House) by pressing the respective main battery switches located on the 12VDC cabin panel. See Figure A1.

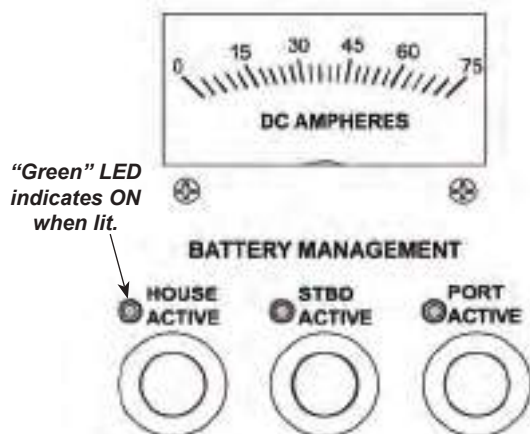


Figure A1: Battery Activation Switches

5. Turn the HELM MAIN circuit breaker switch ON located on the 12VDC cabin panel. See Figure A2.

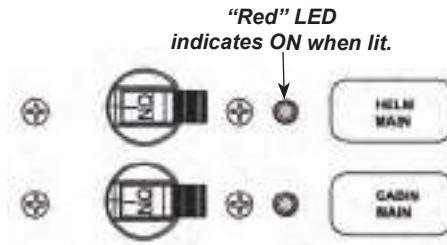


Figure A2: Helm & Cabin Main Circuit Breakers

6. Start and operate the bilge blower system for at least four (4) minutes before start-up.
7. Open the seawater seacocks on the drive units.
8. Place the drive-unit in neutral by moving the control levers to the neutral positions.

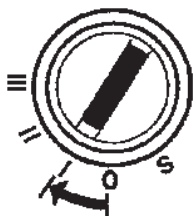
#### B. Starting Procedures

1. Move the dual shift/throttle lever of the control head to the neutral idle detent positions (N). Note: The engine can only be started if the control is in the neutral detent position. When in the neutral idle detent position, press the neutral button "N" in and hold it down while moving the control lever forward to the forward shift position. Release the neutral button. The green indicator begins to flash indicating the shift function has been disengaged. The lever now only controls engine speed which permits engine warm-up. See the manufacturer's literature for further details. Moving the lever back to the neutral detent position will automatically re-engage the shift function which is indicated by the constant green light.

### WARNING

*Take care not to engage the drive-unit unintentionally.*

2. Turn the ignition key to the ON position "I" and wait 20 seconds, allowing pre-heaters to activate. See Figure A3.



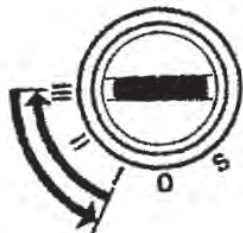
**Figure A3: Ignition Switch ON Position**

3. Check for audible warnings, information messages or alarms on EVC system displays.
4. Activate the control position by pressing the EVC control panel activation button for at least one second. When the button is released, the indication button lights up to confirm that the control position is activated. Note: If the indicator flashes, the control position has not been activated because the control levers are not in the neutral position. See Figure A4.



**Figure A4: EVC Control Panel Activation Button**

5. After 20 seconds, turn key switch to START position and hold until engine starts. DO NOT hold in START position for more than ten seconds. See Figure A5. **Note:** If one of the designated engine batteries fails to start its respective engine, engage the “EMERGENCY START” switch at the helm and attempt to start the engine.



**Figure A5: Ignition Switch START Position**

6. As soon as engine starts, release key to the ON or RUN position.

#### NOTICE

Allow the engine to idle for the first ten seconds. Monitor all instruments and displays to ensure normal readings are shown. Check that no alarms are displayed and that no warning lights are flashing. Then warm the engine at low speed and low load until engine reaches normal temperature before full power is used.

#### NOTICE

Priming is not necessary for EFI engines. Refer to the engine owner's manual for additional information.

#### NOTICE

NEVER turn key to START position when engine is running.

#### NOTICE

Failure to move the throttle handle to the idle position immediately when engine starts will allow engine to “over-rev” and engine damage could result. “Over-revving” engine after off-season storage could also damage the water pump impeller. **When starting engine for the first time after off-season storage, always idle engine for ten minutes to allow the water pump to prime.**

### C. Shifting and Control Speed

#### NOTICE

If your boat is equipped with a non-OEM remote control system, ask your dealer how to properly operate it.

1. Move shift/throttle lever(s) to the neutral idle position. Placing the shift/throttle levers in the neutral detent position will engage neutral start switch and allow engine to start.
2. To go FORWARD - move the shift/throttle lever(s) forward. Once forward gear engagement is complete, push shift/throttle lever(s) forward until desired speed is achieved.

- To go in REVERSE - move the shift/throttle lever(s) rearward. Once rearward gear engagement is complete, push shift/throttle lever(s) rearward until desired speed is achieved.

**WARNING**

*DO NOT shift from forward to reverse when the boat is planing.*

- To go from FORWARD to REVERSE, or REVERSE to FORWARD; always pause at NEUTRAL and allow engine speed to fall below 1500 RPM.

**NOTICE**

*If you attempt to shift gear at an excessive engine speed, a safety function cuts in automatically, and delays shifting until engine speed has fallen below 1500 RPM.*

- After shifting is completed, slowly push throttle lever(s) forward/rearward until desired speed is achieved.

**CAUTION**

*On a boat with twin engines it is important that both engines be running during reverse procedures, to avoid the risk of water entry (via the exhaust pipe) into a stationary engine.*

**WARNING**

*Any time the boat is operated, be aware of changes in shift system operation. A sudden increase in shift effort of the shifter levers, or other abnormal operation, indicates a possible problem in the shift system. If this occurs, the following precautions must be taken:*

- With engine running and boat securely tied to the dock, shift drive into forward and reverse to ensure there is gear engagement.
- When docking the boat, all docking maneuvers must be performed at slow speed. Pay special attention to other boaters. Passengers should be informed of potential problems and precautions taken.

If you suspect there is a problem, see your engine manufacturer's authorized service center as soon as possible for proper diagnosis and required service or adjustment. Continued operation could result in damage to the shift mechanism and loss of control.

**D. Stopping Engine**

1. Move shifter lever(s) to the NEUTRAL position. Allow engines to idle for a few minutes (in neutral) before turning them OFF. This will avoid boiling and even out the temperature. This is especially important if the engines have been operated at high engine speeds and loads.
2. Turn ignition key to the STOP position "S" Keep the key turned until the engine stops. The key will automatically return to the OFF position "0" when released and then can be removed. See Figure A6.



**Figure A6: Ignition Switch STOP Position**

**CAUTION**

*Never switch OFF the main battery switches while engines are running. This could damage the alternator.*

**CAUTION**

*Never switch OFF the main battery switches before the starter key is turned OFF (is in the "0" position or removed). This could damage the electrical system.*

**CAUTION**

*DO NOT stop engine at speeds above idle or "speed up" engine while turning off ignition. Engine damage could result.*

With the Inboard Performance System (IPS) engines, when they are stopped the drive-units will automatically be positioned in the straight forward position.



## E. After Stopping Engines



Ensure the starter key is turned OFF (is in the "0" position or removed) before main battery switches are turned OFF. Otherwise the electrical system could be damaged.

1. Inspect the engines and engine compartment for any leaks.
2. Switch OFF the main battery switches located at the at the 12VDC cabin panel if the boat is not to be used for some time.

## A - 10 GROUNDING AND TOWING



If the boat should become disabled, or if assisting another craft that is disabled, great care must be taken. The stress applied to a boat during towing may become excessive. Excessive stress can damage the structure of the boat and create a safety hazard for those aboard.

Four Winns® boats are not designed nor intended to be used as a towing vessel. The mooring cleats on Four Winns® boats are not designed or intended to be used for towing purposes. These cleats are specifically designed as mooring cleats for securing the boat to a dock, pier, etc. DO NOT use these fittings for towing or attempting to free a grounded vessel.

Freeing a grounded vessel or towing a boat that is disabled requires specialized equipment and knowledge. Line failure and structural damage caused by improper towing have resulted in fatal injuries. Because of this, Four Winns strongly suggests that these activities be left to those who have the equipment and knowledge such as the US Coast Guard or Sea Tow®, to safely accomplish the towing task.



Running aground can cause serious damage to a boat and associated underwater gear. If the boat should become grounded, distribute personal flotation devices and inspect the boat for possible damage. Thoroughly inspect the bilge area for signs of leakage. An experienced service facility should check the hull and underwater gear at the first opportunity. DO NOT continue to use the boat if the condition of the hull or underwater equipment is questionable.

If towing or being towed is absolutely necessary, use the strongest lines available, and attach them to the bow eyes or stern eyes only. Have all passengers slip on life jackets and take a seat in the cabin or other protected area.



Lines can snap or other hardware can be loosened or broken while towing. Under certain conditions, this can cause severe injury or fatality.

## A - 11 BOATING EDUCATION

### A. Boating Courses

Boating education classes are offered throughout the country. The United States Coast Guard Auxiliary offers free courses on different topics usually during the off-season. The most popular course is the "Boating Skills & Seamanship Course," and information can be obtained by calling 1 800-336-BOAT (2628) or by visiting their website at: [www.boatus.com/courseline](http://www.boatus.com/courseline).

The United States Power Squadron also offers free courses ranging from basic seamanship to celestial navigation. For information, contact your local Power Squadron, or write: USPS, P.O. Box 30423, Raleigh, NC 27622 or visit their website at: [www.usps.org](http://www.usps.org).

The World Wide Web contains many websites devoted to boating and boating safety. One such site is [www.discoverboating.com](http://www.discoverboating.com) which contains many informative articles and website links for both the new



boater as well as the experienced boater alike. The Canadian Power and Sail Squadron offers seamanship courses. Information may be obtained by visiting their website at [www.cps-ecp.ca/](http://www.cps-ecp.ca/).

## B. Boating Manuals or Literature

A good source of information is the US Coast Guard's home study book called "The Skipper's Course". This book may be purchased through Superintendent of Documents, US Government Printing Office, Washington, DC 20402, Stock # 050-012-00159-6.

Another good source of boating information is Chapman's "Piloting, Seamanship and Small Boat Handling". Also, check the local library or bookstore for additional information on boating.

## C. Charts and Maps

US nautical charts are sold throughout the country at Governmental Printing Office stores and other agents. Chart catalogs are available by visiting the National Oceanic and Atmospheric Administration website at <http://nauticalcharts.noaa.gov/mcd/ccatalogs.htm#state>.

In addition, many federal agencies publish recreational maps, including the US Army Corp of Engineers, the Forest Service, the National Park Service, and the Tennessee Valley Authority.

Addresses of all state boating law administration offices are found in the "Boating Basics, A Guide to Responsible Boating", included in your owner's packet. Additional copies may be purchased by contacting Outdoor Empire Publishing at [www.outdoor-empire.com](http://www.outdoor-empire.com).

## D. Laws and Regulations

The US Coast Guard is the authority of the waterways; they are there to help the boating public. State boating regulations are enforced by local authorities. You are subject to marine traffic laws and "Rules of the Road" for both federal and state waterways; you must stop if signaled to do so by enforcement officers, and permit to be boarded if asked.

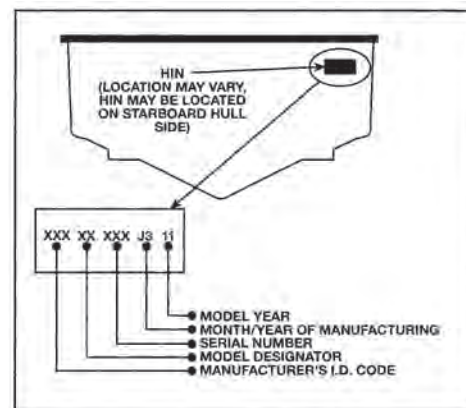
There are many pamphlets, prepared by the US Coast Guard, available to you. These pamphlets explain "Rules of the Road," signal lights, buoys, safety, international and inland regulations and other information which goes beyond the scope of this manual.

For more information contact your local US Coast Guard Unit or call the Coast Guard info line at 1 800 368-5647, or visit the US Power Squadron website at [www.usps.org](http://www.usps.org).

## A - 12 BOAT OWNER REGISTRATION

Federal and state laws require that every boat equipped with propulsion machinery of any type must be registered in the primary state of usage. Registration numbers and validation stickers must be displayed on the boat according to regulations. In most states, this means registration with the designated state agency. In a few jurisdictions, the Coast Guard retains registration authority. Your dealer will either supply registration forms or tell you where they may be obtained. The registration agency will issue you a certificate that must be carried on board when the boat is in use. Some states require additional registration when an out of state boat is used within their boundaries.

Your boat has a hull identification number on the starboard side of the hull. Figure A7 shows a typical identification number. Use this hull identification number for registration and to identify your boat for warranty service.



**Figure A7: HIN**

In most states, the boat owner is legally responsible for damages or injuries he or she causes, even if someone else is operating the boat at the time of the accident. Common sense dictates that you carry adequate personal liability and property damage insurance on your boat, just as you would on an automobile. You should also protect your investment by insuring your boat against physical damage or theft.

## A - 13 ACCIDENT REPORTING

The operator of the boat is responsible for filing a report with the appropriate authorities. In general, reports are necessary for accidents involving loss of life, injury, or damage over \$500. In the case of accidents with reportable injuries or death, a formal report is required within 48 hours. If only property damage is involved, a report must be made within ten days. The 1971 Boating Safety Act may impose a \$1,000 civil fine for people who fail to submit a boating accident report. Ask your insurance agent for more information.

If you see a distress signal, you must assume it is a real emergency and render assistance immediately. The master or person in charge of a boat is obligated by law to provide assistance to any individual in danger at sea. However, you should not put your boat or crew in a dangerous situation which exceeds your capabilities or those of your boat. The 1971 Boating Safety Act grants protection to a Good Samaritan boater offering good faith assistance, and absolves a boater from any civil liability arising from assistance given.

## A - 14 DISCHARGE OF OIL

The Federal Water Pollution Control Act prohibits the discharge of oil waste into or upon the navigable waters of the United States or the waters of the contiguous zone if such discharge causes a film or sheen upon or a discoloration of the surface of the water or causes a sludge or emulsion beneath the surface of the water. Violators are subject to a penalty of \$5,000.

## A - 15 DISPOSAL OF PLASTICS & OTHER GARBAGE

Plastic refuse dumped in the water can kill fish and marine wildlife and can foul boat propellers and cooling water intakes. Other forms of waterborne garbage can litter our beaches and make people sick. US Coast Guard and most state regulations prohibit the dumping of plastic refuse or other garbage mixed with plastic into the water anywhere, and restrict the dumping of other forms of garbage within specified distances from shore.

## A - 16 MARPOL TREATY

Boats 26 feet or longer must display a sign stating the disposal regulations of the Federal Water Pollution Control Act. The US Coast Guard has issued these regulations to implement Annex V of the International Convention for the Prevention of Pollution from Ships, 1973, commonly known as Annex V of the MARPOL (Marine Pollution) Treaty 73/78. They apply to all US boats wherever they operate (except waters under the exclusive jurisdiction of a State) and foreign boats operating in US waters out to and including the Exclusive Economic Zone (200 miles). It is important to know these regulations and adhere to them.

The regulations require US recreational boaters, if your boat is 26 feet or more in length, to affix one or more USCG Trash Dumping Restrictions placards to your boat. The placard warns against the discharge of plastic and other forms of garbage within the navigable waters of the United States and specify discharge restrictions beyond the territorial sea. (The territorial sea generally ends three nautical miles from the seashore.) In addition, the placard must contain the warning that a person who violates these requirements is liable to civil (\$25,000) and criminal (imprisonment) penalties. The placard also must note that State and local regulations may further restrict the disposal of garbage.

Operators shall display one or more placards in a prominent location and in sufficient numbers so they can be observed and read by crew and passengers. These locations might include embarkation points, food service areas, galleys, garbage handling spaces and common deck spaces frequented by crew and passengers. We recommend that these placards may be purchased from local marinas, boat dealerships and marine equipment suppliers. A special placard is available for boats operating on the Great Lakes.

### NOTICE

*IMPORTANT: It is illegal to discharge waste from your marine sanitary device (toilet) into the water in most areas. It is your responsibility to be aware of and adhere to all local laws concerning waste discharge. Consult with the Coast Guard, local marina or your dealer for additional information.*

**NOTICE**

*NOTE: Some states and localities have legal limits on speed, noise and trailer specifications. It is your responsibility to be aware of these laws and limits and to insure that your boat (and trailer) comply. Consult with your local Marine Patrol or local Coast Guard office.*



## B - 1 GENERAL

As the owner/operator of the boat, you are responsible for assuring that all required safety equipment is aboard. You should also consider supplying additional equipment as needed for your safety and that of your passengers. Check state and local regulations and call the US Coast Guard Boating Safety Hotline at 1-800-368-5647 for information about required safety equipment.

### A. Required Safety Equipment

Minimum requirements include the following:

- Personal Flotation Devices (Life Jackets)
- Visual Distress Signal
- Bell or Whistle
- Fire Extinguishers
- Navigation Lights

#### NOTICE

*As the owner/operator of the boat, you are responsible for assuring that all required safety equipment is aboard and meets the boating regulations as prescribed by both federal and local authorities in your area.*

### B. Personal Flotation Devices (PFDs)

Federal regulations require that you have at least one Coast Guard approved personal flotation device (PFD) for each person in a recreational boat. You should not use your boat unless all PFDs are in serviceable condition, readily accessible, legibly marked with the Coast Guard approval number, of an appropriate size (within the weight range and chest size marked on the PFD) for each person aboard.

A PFD provides buoyancy to help keep your head above the water and to help you remain in a satisfactory position while in the water. Body weight and age should be considered when selecting a PFD. The buoyancy provided by the PFD should support the person's weight in the water.

The size of the PFD should be appropriate for the wearer. Body weight or chest size are common methods used to size PFDs. It is your responsibility to ensure that you have the proper number and types of PFDs on board and that your passengers know where and how to use them.

### C. PFD Types

Five types of PFDs have been approved by the US Coast Guard. The PFDs are described as follows:

**PFD Type 1, Wearable** (Figure B1) has the greatest required buoyancy. Its design allows for turning most unconscious persons in the water from face down position to a vertical or slightly backward, face-up position. It can greatly increase the chances of survival. Type 1 is most effective for all waters, especially offshore when rescue may be delayed. It is also the most effective in rough waters.



**Figure B1: Type I, Wearable**

**PFD Type II, Wearable** (Figure B2) turns its wearer in the same way as Type I, but not as effectively. The Type II does not turn as many persons under the same conditions as a Type I. You may prefer to use this PFD where there is a probability of quick rescue such as in areas where other people are commonly involved in water activities.



**Figure B2: Type II, Wearable**

**PFD Type III, Wearable** (Figure B3) allows the wearer to place themselves in a vertical or slightly backward position. It does not turn the wearer. It maintains the wearer in a vertical or slightly backward position and has no tendency to turn the wearer face down. It has the same buoyancy as a Type II PFD and may be appropriate in areas where other people are commonly involved in water activities.



**Figure B3: Type III, Wearable**

**PFD Type IV, Throwable** (Figure B4) is required in addition to the PFDs previously discussed. The most common Type IV PFD is a buoyant cushion or ring buoy. It is designed to be thrown to a person in the water, grasped and held by the user until he or she is rescued. A Type IV PFD should always be in serviceable condition and immediately available for use. Grasping this PFD may be difficult if the rescue is delayed or if the user is overcome by hypothermia (loss of body heat).



**Figure B4: Type IV, Throwable**

**PFD Type V, Wearable** (Figure B5) when inflated, it provides buoyancy equivalent to Type I, II, or III PFDs. When it is deflated, however, it may not support some people.



**Figure B5: Type V, Wearable**

#### **D. PFD Pointers**

The purpose of a PFD is to help save your life. If you want it to support you when you are in the water, it needs to fit, float, and be in good condition.

1. Try the PFD on and adjust it until it fits comfortably in and out of the water. Mark your PFD if you are the only wearer.
2. To make sure the PFD works, wear it in the water. This will show you how it works and give you confidence when you use it.

3. Teach children how to put a PFD on and allow them to try it in the water. That way, they know what the PFD is for and how it works. They will feel more comfortable with it if they suddenly find themselves in the water.
4. If the PFD is wet, allow it to dry thoroughly before storing it. Do not dry it in front of a radiator or heater. Store it in a well ventilated area.
5. Keep PFDs away from sharp objects which can tear the fabric or puncture the flotation pads.
6. For their own safety and the safety of others, all nonswimmers, poor swimmers, and small children should wear PFD's at all times, whether the boat is stationary or moving.
7. Check the PFD frequently to make sure that it is not torn, that flotation pads have no leaks, and that all seams and joints are securely sewn.
8. If a PFD contains kapok, the kapok fibers may become waterlogged and lose their buoyancy after the vinyl inserts are punctured. If the kapok becomes hard or if it is soaked with water, replace it. It may not work when you need it.

#### **E. Fire Extinguisher**

As the owner/operator of the boat, you are responsible for supplying a fire extinguisher(s) approved by the US Coast Guard.

Hand-held portable extinguisher(s) should be mounted in a readily accessible location(s) away from the engine compartment. All persons aboard should know the location(s) and proper operation of the fire extinguisher(s).



#### **Fire!**

*In case of fire do not open the engine compartment. Shut down engine(s), generator(s), and blower(s). Models with fixed fire suppression system will automatically discharge its entire contents. If using portable CO2 fire extinguisher continuously discharge entire contents.*



**NOTICE**

*Do not test fire extinguishers by squirting small amounts of the extinguishing compound. The fire extinguisher might not work when you really need it.*

The V475 model measures 49' 4" (15.03 m) with the extended swim platform and measures 44' 6" (13.56m) which is the molded length without extended swim platform. The V475 is considered a Class 3 powerboat. All Class 3 powerboats are required to carry a minimum of three (3) B-1 type, US Coast Guard approved, hand portable fire extinguishers when there is **no** fixed fire extinguishing system in the machinery space. However, since the V475 is equipped with a fixed fire extinguishing system in the machinery space the minimum requirement of two (2) B-1 type approved hand portable fire extinguishers is required. **Additional note:** One (1) B-11 type approved hand portable fire extinguisher may be substituted for two (2) B-1 type approved hand portable fire extinguishers.

**F. Fire Extinguisher System**

An automatic HFC-227ea agent fire extinguisher system in conjunction with an automatic shutdown system are standard on the V475 models. If fire breaks out aboard a diesel powered vessel, the engine(s) must be shut down immediately for the fire extinguisher system to effectively extinguish the fire. Continued engine operation may remove the agent, lowering the concentration required to effectively extinguish the fire.

The equipment utilized has been so chosen, and located, to provide sufficient volume and coverage of the entire engine compartment. While the system ensures excellent overall bilge fire protection, it does not eliminate the USCG requirement for hand-held fire extinguishers. Refer to the manufacturer's literature included in the owner's packet.

**G. Visual Distress Signal Devices**

Visual distress signal devices approved by the US Coast Guard are required on all recreational boats operating on coastal waters and to boats owned in the United States when they are operating on the high seas. Coastal waters include territorial seas and those waters directly connected to the Great Lakes and the territorial seas up to a point where the waters are less than two miles (3.2km) wide. Visual distress signal

equipment may be of the pyrotechnic or non-pyrotechnic type. Regulations prohibit display of visual distress signals on the water under any circumstances except when assistance is required to prevent immediate or potential danger to persons on board a vessel.

The equipment must be approved by the US Coast Guard, be in serviceable condition, and be stowed in a readily accessible location. Equipment having a date for serviceable life must be within the specified usage date shown. Careful selection and proper stowage of visual distress equipment is very important if young children are aboard.

DAY USE ONLY	NIGHT USE ONLY	DAY AND NIGHT USE
Three orange smoke signals (one hand held and two floating) or one orange flag with black square and disk.	One S-O-S electric distress light.	Three flares of the hand held, meteor or parachute type.

*Distress Signal Table*

The minimum visual distress signals required in coastal waters for a Class 3 powerboat is the following:

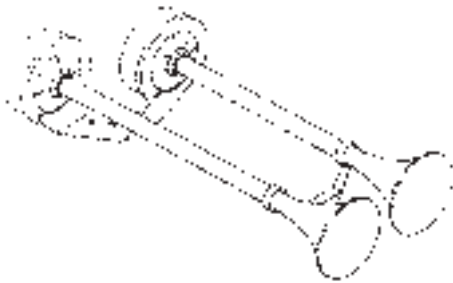
One orange flag with black square-and disc (daytime); and an S-O-S electric light (nighttime); or three orange smoke signals, hand held or floating (daytime); or three red flares of hand held, meteor, or parachute type (daytime/nighttime).

**NOTICE**

*No single signaling device is appropriate for all purposes. Consider keeping various types of equipment on board.*

**H. Sound Signaling Devices**

Class 3 powerboats are required to carry a hand, mouth or power operated horn or whistle. It must produce a blast of two-second duration and audible at a distance of at least one-half (1/2) mile. The V475 model is equipped with a dual trumpet horn which meets this requirement. See Figure B6.



**Figure B6: Dual Trumpet Horn**

The following are standard whistle signals:

- One Prolonged Blast = Warning Signal
- One Short Blast = Pass on my Port Side
- Two Short Blasts = Pass on my Starboard Side
- Three Short Blasts = Engines in Reverse
- Five or More Blasts = Danger Signal

#### I. Navigation Lights

Navigation lights are intended to keep other vessels informed of your presence and course. If you are out on the water between sunset and sunrise, you are required to display appropriate navigation lights.

#### J. Additional Recommended Equipment

Four Winns recommends that you acquire additional equipment for safe, enjoyable cruising. This list, which is not all inclusive, includes items you should consider acquiring.

##### Basic Gear

Flashlight	Spare batteries	Tow line
Oar, paddle	Mooring lines	Compass
Dock fenders	Distress signals	First aid kit
Boat hook	VHF radio	EPIRB*
Sunscreen	Extra warm clothing	Charts
Second anchor & line		
Dewatering device (pump or bailer)		
Emergency supply of drinking water and food.		
*Emergency Position Indicating Radio Beacon		

##### Tools

Spark plug wrench	Hammer	Screwdriver
Jackknife	Pliers	
Electrical tape	Duct tape	
Adjustable wrench	Lubricating oil	Prop wrench

##### Spare Parts

Extra bulbs	Spare prop	Extra fuses
Extra drain plug	Spark plugs	Spare wire
Extra prop nut/washer		

##### Gear For Extended Cruises

Foul weather gear	Parallel rulers	Dividers
Global Positioning System navigation equipment		

## B - 2 CARBON MONOXIDE



### Carbon Monoxide!

*Carbon monoxide (CO) can be harmful or fatal if inhaled. Brain damage or death can result from prolonged exposure to carbon monoxide. Keep exhaust outlets clear of blockage. Provide adequate ventilation. Open hatches, doors, windows and vents to insure adequate ventilation. Close engine compartment doors and hatches when engine or generator is running. Avoid operating the boat for extended periods of time at idle speed, and be sensitive to weather conditions that may prevent CO from dissipating into the air. Do not stand or swim near engine or generator exhausts when engines are running.*

Carbon monoxide accumulation is affected by many variables (e.g., boat geometry, hatch, window and door opening, ventilation openings, proximity to other structures, swim platforms, canvas enclosures, location of exhaust outlets, vessel attitude, wind direction, vessel speed, boat systems maintenance, etc.) The technical information included in this section is to inform the boat owner of possible cause and effects of carbon monoxide exposure. This information has been reprinted with permission from the American Boat and Yacht Council's (ABYC) technical information report: "Educational Information About Carbon Monoxide". This information pertains to all gasoline powered boats manufactured by Four Winns.

### NOTICE

*The boat owner should be aware that other factors may contribute to carbon monoxide accumulation. The most common ones are listed in this section. If a person is exhibiting carbon monoxide-type symptoms (Refer to B-2E Symptoms), be sure to take the necessary precautions as prescribed later in this section.*

### NOTICE

*Boats fueled by diesel have limited carbon monoxide present in the exhaust in comparison to gasoline engine exhaust. However, the boat owner should still be aware of the causes and effects of carbon monoxide which may occur in different boating situations.*

#### A. Properties and Characteristics of Carbon Monoxide

1. Carbon Monoxide is a colorless, odorless and tasteless gas. It is commonly referred to as CO.
2. Its weight is about the same as air so it cannot be expected to rise or fall like some other gases, but will distribute itself throughout the space.

### NOTICE

*DO NOT rely on the use of smell or sight of other gases to detect CO, because it diffuses in the air much more rapidly than easily detectable vapors (i.e. visible and aromatic vapors).*

#### B. What Makes Carbon Monoxide

Any time a material containing carbon burns such as gasoline, natural gas, oil, propane, coal, or wood, CO is produced.

Common sources of carbon monoxide are:

1. Internal combustion engines such as:
  - a. Propulsion engines
  - b. Generators
2. Open flame devices such as:
  - a. Cooking ranges
  - b. Central heating plants
  - c. Space heaters
  - d. Water heaters
  - e. Fireplaces
  - f. Charcoal grills

#### C. How a Person is Affected by Carbon Monoxide

Carbon monoxide is absorbed by the lungs and reacts with blood hemoglobin to form carboxyhemoglobin, which reduces the oxygen carrying capacity of the blood. The result is a lack of oxygen for the tissues with the subsequent tissue death and, if exposure is prolonged, death of the individual.

#### D. Effects of Carbon Monoxide

Carbon monoxide in high concentrations can be fatal in a matter of minutes. Lower concentrations must not be ignored because the effects of exposure to CO are cumulative and can be just as lethal.

Certain health related problems and age will increase the effects of CO. People who smoke or are exposed to high concentrations of cigarette smoke, consume alcohol or have lung disorders or heart problems, are particularly susceptible to an increase in the effects from CO. However, all occupants' health should be considered. Physical exertion accelerates the rate at which the blood absorbs CO.

#### E. Symptoms

One or more of the following symptoms can signal the adverse effect of CO accumulation:

1. Watering and itchy eyes
2. Flushed appearance
3. Throbbing temples
4. Inattentiveness
5. Inability to think coherently
6. Loss of physical coordination
7. Ringing in the ears
8. Tightness across the chest
9. Headache
10. Drowsiness
11. Incoherence
12. Slurred speech
13. Nausea
14. Dizziness
15. Fatigue
16. Vomiting
17. Collapse
18. Convulsions

### NOTICE

*The order of the above list is generally the sequence of appearance of symptoms. However, the order of appearance may change for different people.*

### NOTICE

*The symptoms of Carbon monoxide poisoning may easily be mistaken for seasickness.*

## F. Treatment (Evaluate, Ventilate, Evacuate, Investigate, Take Corrective Action)

1. Evaluate the situation and ventilate the area if possible.
2. Evacuate the area and move affected person(s) to a fresh air environment.
3. Observe the victim(s).
4. Administer oxygen if available.
5. Contact medical help. If the victim is not breathing, perform rescue breathing or approved cardiopulmonary resuscitation (CPR), as appropriate, until medical help arrives and takes over.

### NOTICE

*Prompt action can make the difference between life and death.*

6. Investigate source of CO and take corrective action.

## G. Inspection

Look and listen for leaks in the exhaust systems of both the generator and propulsion engine(s). Look for discoloration around joints in the system (water leaks, carbon, stains, etc.).

1. Make sure all exhaust clamps are in place and secured.
2. Make sure ventilation systems work and are not obstructed or restricted.
3. Make sure gaps around the engine room plumbing and cableways and exhaust system doors, hatches, and access panels are minimized to reduce the opportunity for CO to enter the accommodation space(s).

## H. Operation

**Cold Start vs. Warm Start:** CO production is greater while the combustion chamber surfaces and gas passages are cold versus when they are warm. A boat operator should:

1. Pay attention to ventilating the boat.
2. Orient the boat so it will allow the maximum dissipation of CO.

3. Minimize the time spent on getting underway.
4. In order to minimize CO buildup, do not warm up or run propulsion engine(s) for extended periods while the vessel is stationary.



*The following are examples of possible situations where carbon monoxide can accumulate within your boat while docked, anchored, or underway. Become familiar with these examples and their precautions to prevent dangerous accidents or death.*

## I. Boathouses, Sea Walls and Confined Spaces

A boat operator should be aware that dangerous concentrations of CO can accumulate when a boat, generator or other engine operated device is operated while the boat is moored in a confined area such as:

1. Boathouses,
2. Proximity to sea walls, or
3. Proximity to other boats.

Keep engine room hatches and doors closed when operating engines, including the generator.

Pay attention to prevailing conditions and provide for ventilation to induce fresh air and minimize exhaust re-entry. Orient the boat for maximum dissipation of the exhaust. **DO NOT** run the boat or boat equipment for extended periods under these conditions. See Figure B7.



**Figure B7: The effect of sea walls and other confined spaces.**

Be aware that cockpit and deck drains can be a source of CO ingress into boats, especially boats with cockpit or decks enclosed with canvas or permanent boat structures.

## J. The Effect of Boats Moored Alongside

A boat operator should be aware that carbon monoxide is emitted from any boat's exhaust. The operation, mooring, and anchoring in an area containing other boats may be in an atmosphere containing CO not of the operator's making. An operator likewise needs to be aware of the effect of their boat on other boats in the area. Of prime concern is the operation of an auxiliary generator where boats are moored alongside each other. Be aware of the effect your exhaust may have on other boats and be aware that the operation of other boats' equipment may affect the carbon monoxide concentration on your boat. See Figure B8.

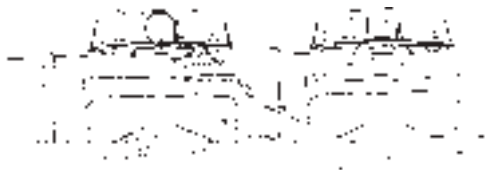


Figure B8: The effect of boats moored along side.

## K. Backdrafting (Station Wagon Effect)

Backdrafting or the "station wagon effect" is caused by air movement over or around a boat creating a low pressure area or suction area around the stern that can increase CO level on the boat. Backdrafting can be affected by relative wind direction, boat speed, and boat trim angle. See Figure B9 Backdrafting - Airflows Over Boat and Behind Transom".

Under certain speed and operating conditions the low pressure area may form in other regions and permit carbon monoxide to enter the hull through openings that are not on the back of the boat. Boat factors which may affect CO concentration:



Figure B9: Backdrafting - Air flows over boat and behind transom.

1. Intentional or unintentional excessive trim angle causing high bow angle. See Figure B10.
2. Excessive or unequally distributed weight.

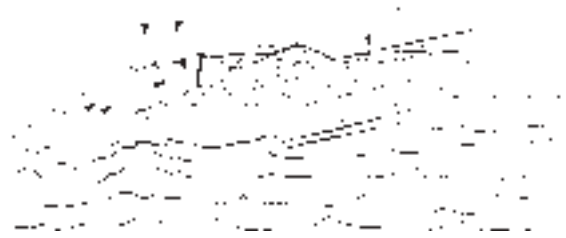


Figure B10: Inefficient trim angles.

3. Canvas Configurations - Under various conditions, adding or removing canvas may raise or lower CO levels. See Figures B9, B10 & B12.



### Exhaust Fumes!

Hull exhaust from your boat can cause excessive accumulation of poisonous carbon monoxide gas within cockpit areas when using protective weather coverings (while underway or while stationary). Provide adequate ventilation when the canvas top, side curtains and/or back (aft) curtains are in their closed protective positions.

4. Opening and closing ports, hatches, doors, and windows may raise or lower CO levels on board a boat. When airflow is moving forward inside the boat, CO may be entering the boat. See Figures B11 and B12.



Figure B11: Desired air flow through the boat.



Figure B12: The effect of canvas configurations.

5. Operating a boat at slow speeds with a following wind should be avoided. Consider changing direction, adjusting speed, or both. See Figures B13.





**Figure B13: Operating at Slow Speed with Following Wind**

6. Be aware that cockpit and deck drains can be a source of CO ingress into boats, especially boats with cockpit or decks enclosed with canvas or permanent boat structures.

#### **L. Accumulation of Exhaust Gases- Swim Platform**

When the propulsion engine(s) or generator is running, CO is produced and may remain in the vicinity of the exhaust outlet (including underwater exhaust outlets such as sterndrives and outboards). Refer to Figure B14.

1. Do not occupy aft lounging area(s) or swim platform.
2. Do not swim under or around swim platform.
3. Do not swim in the vicinity of the exhaust outlet.



**Figure B14: Exhaust Gas Accumulation at Swim Platform**

#### **M. Dangerous Activity - "Teak Surfing"/"Dragging"**

Do not sit on, occupy or hang on any stern appendages (e.g., swim platforms, boarding ladders, etc.) while underway. Do not body surf, commonly known as "teak surfing" or "dragging", etc. in the wake of the boat. Do not tow persons in close proximity to the stern of the boat. See Figure B15.



**Figure B15: Exhaust Gas Accumulation - Dangerous Activity**

#### **N. Cabin Appliances**

Boats having fuel burning appliances in accommodation areas should be provided with adequate ventilation and the appliance should be maintained to function properly.

#### **O. Air Conditioning**

Lack of system maintenance may cause CO to be brought into the air-conditioned spaces by the air conditioner. Please refer to the air conditioner manufacturer's literature for additional information.

#### **P. Ventilation of Accommodation (Occupied) Spaces**

Accommodation spaces need to be ventilated to introduce fresh air into the spaces. Ventilation methods (e.g. windows, hatches, doors, and blowers) used to accomplish this may, under certain conditions, bring hazardous levels of CO into the occupied spaces. Care should be taken to be aware of all prevailing conditions when using these ventilating methods.

#### **Q. Running of Engines in Idle**

Engines running in idle exhaust carbon monoxide that can accumulate near the hull of the boat. Do not stand or swim near the engine exhaust or outdrive when engines are idling or generator is running.

#### **R. Altitude and Sea Conditions**

Operation at altitudes greater than 5,000 feet contributes to inefficient engine performance and may require adjustments to the ignition systems, fuel systems, or changing the propeller's size or gear ratio.

1. Failure to make adjustments to ignition systems and/or fuel systems for altitude conditions may cause an increase in CO production.
2. Reduced power resulting from increased altitude may require adjustments to propeller size.



3. Heavy sea or out of trim conditions tend to load engines resulting in reduced performance and thereby increasing their CO production.

#### S. Portable Generator Sets



*Never use a portable generator on a boat.*

Gasoline powered portable generators are available in the marine market place and are not an option available through Four Winns. Portable generators will produce CO. These sets discharge their exhaust products in locations which can lead to an increase in the accumulation of carbon monoxide in the accommodation (occupied) space. **Do not use gasoline powered portable generators on Four Winns® boats.**

#### T. Maintenance - Engine Performance

Efficient engine performance is vital to minimizing CO production. The following items are those considered to have the greatest effect on increased CO production:

1. Fuel Systems - Fuel that is contaminated, stale or incorrect octane number
2. Carburetors/Injectors
  - a. Dirty or clogged flame arrester
  - b. Malfunctioning automatic choke plate or faulty adjustment of manual choke plate
  - c. Worn float needle valve and seat
  - d. High float level
  - e. Incorrect idle mixture adjustment
  - f. Dirty or worn injectors
3. Ignition System
  - a. Fouled or worn spark plug.
  - b. Worn points or incorrect gap on points
  - c. Shorted or opened circuit high tension spark plug cables
  - d. Incorrect ignition timing.

#### 4. General

- a. Worn piston rings and valves
- b. Engine temperature - Cold running engines increase CO production. Engine cooling water system design and selection of thermostat(s) are primary considerations affecting engine operating temperature. Generally, an engine produces less CO if it operates at a relatively high temperature within manufacturer's specifications.
- c. Exhaust Back-Pressure - Certain alterations to the exhaust system may increase engine exhaust back pressure and CO production.
- d. Restricted engine room or compartment ventilation

#### U. Maintenance - External Conditions

External conditions that contribute to inefficient engine performance can include:

1. Fouled hull bottom
2. Damaged and fouled running gear (i.e., shaft, strut propeller, rudder and trim tabs)
3. Incorrect selection of propeller size

#### V. Maintenance - Exhaust System Integrity

Gas tight integrity of exhaust systems must be maintained to insure that leakage of CO within the boat does not occur. Disassembly may be required to carry out a thorough inspection. Repair or replace components as indicated. Inspect the following:

1. Gaskets at cylinder head connection
2. Casting and pipe fittings in the dry section
3. All joints
4. Hoses
5. Clamps
6. Mufflers and their drain plugs
7. Thru-hull fittings
8. Hangers and other supports

## W. Maintenance - Ventilation Systems

Boats are equipped with ventilation systems to eliminate gasoline vapors. Blowers and fans may also be provided for ventilation and to mitigate the migration of CO into occupied compartments. Attention should be paid to the following:

1. Keeping ventilation intakes clear of debris
2. Replacing damaged hardware
3. Maintaining the integrity of the ducting material and its connections
4. Ensuring that position of ducting intake is not obstructed or restricted, collapsed, kinked, or crushed.
5. Eliminating sags in ducting that can form a water trap
6. Checking hangers and other supports
7. Ensuring blower/fan is operational
8. Ensuring that airflow is present at discharge
9. Inspecting wiring to equipment

## X. Maintenance - Bulkhead and Deck Integrity

1. Seal all visible openings (e.g., cracks, crevices, holes, including openings around wiring and piping runs) in bulkheads and decks that separate machinery compartments from occupied compartments. These openings can permit migration of CO vapors.
2. Check gaskets and sealing surfaces on hatches, doors, and access panels.

## Y. Maintenance - Air Conditioning Systems

These systems can be a source of CO ingress and migration of CO vapors.

1. Keep grilles and filters clean.
2. Seal bulkhead voids and openings at wiring and piping runs in return air ducting, plenums, and air handling equipment enclosures, especially those adjacent to machinery compartment bulkheads.

3. Check that water traps and condensate drains are present. These may be in the form of a double loop in the drain line or prefabricated p-traps. Any drain that discharges below the waterline when the boat is underway is sealed, by virtue of its design, against CO intrusion.

## Z. Maintenance - Liquid Drains

Sink, shower and condensate drains can be a source of CO ingress. Ensure that water traps are present and contain fluid. These traps may be in the form of a double loop in the drain line or prefabricated p-traps. Any drain that terminates below the waterline is, by virtue of its design, sealed against CO intrusion. Some drains that are below the waterline when boat is underway will be above the waterline when the boat is at rest. The location of drains, relative to the waterline, can be affected by the dynamics of boat motion (i.e., underway or at rest).

## AA. Carbon Monoxide Detection Systems

Four Winns has included three CO detectors as a standard feature. The CO detectors are located in the forward master stateroom, the main cabin/salon and the mid cabin stateroom. Read the manufacturer's manual included in your owner's packet regarding CO monitor operation, testing and maintenance procedures.



*Unit should be cleaned weekly without the use of solvents. Cleaning solvents and oils can cause the alarm to stop functioning. Test the alarm if it has come in contact with any cleaning solvents or any condition that may cause the alarm to stop working.*



*Never disarm a CO detector. If a CO detector alarms, immediately ventilate the area and check passengers for symptoms of CO intoxication. See your Four Winns dealer for assistance in diagnosing the cause for the alarm.*

### NOTICE

*For information on CO Detection Systems, see American Boat and Yacht Council (ABYC Manual) Section A-24, "Carbon Monoxide Detectors".*

Even with the best of boat design and construction along with the utmost care in inspection, operation, and maintenance of boat systems, hazardous levels of CO may still be present in accommodation spaces and exterior areas under certain conditions. Vigilant observation of passengers for CO sickness symptoms should be supplemented by a marine CO detection device in the accommodation space.

 **WARNING**

*A CO detector is not a gas/fuel vapor detector. Gas/fuel vapor detectors do not monitor the buildup of carbon monoxide in an enclosed area. For further information on the design, construction, and testing of boats in consideration of carbon monoxide, see ABYC TH-23.*

### NOTICE

*Detection devices shall meet the requirements of ABYC A-24 "Carbon Monoxide Detection Systems on Boats".*

## B - 3 SAFE BOATING PRACTICES

### NOTICE

*YOU are responsible for your own safety, the safety of your passengers, and the safety of fellow boaters.*

### A. Drugs and Alcohol

 **WARNING**

*Alcohol consumption and boating do not mix! Operating under the influence endangers the lives of your passengers and other boaters. Federal laws prohibit operating a boat under the influence of alcohol or drugs.*

Do not use drugs or drink alcohol while operating a boat. Like driving a car, driving a boat requires sober, attentive care. Operating a boat while intoxicated or under the influence of drugs is not only dangerous,

but it is also a Federal offense carrying a significant penalty. These laws are vigorously enforced. The use of drugs and alcohol, singly or in combination, decreases reaction time, impedes judgement, impairs vision, and inhibits your ability to operate a boat.

### B. Safe Operation

Safe operation means that you do not misuse your boat nor do you allow your passengers to do so. Safe operation means using good judgement at all times. It includes, without limitation, the following actions:

- Observe all safety signs and warnings both inside the boat and in the immediate boating area.
- Become familiar with, and adhere to, the "Rules of the Road".
- Maintain boat speed at or below the legal limits. Avoid excessive speed or speeds not appropriate for operating conditions.
- Be sure at least one other passenger is familiar with the operation and the safety aspects of the boat in case of an emergency.
- Load the boat within the limits listed on the capacity plate. Balance loads bow and stern and port to starboard.
- Do not use the boat in bad weather or sea conditions beyond the skill or experience of the operator or the comfortable capability of the boat or passengers.
- Make sure the passengers and gear do not obstruct the operator's view or impede his ability to move.
- Do not exceed the maximum engine power rating stated on the certification plate located inside the boat.

### C. Passenger Safety

Before getting underway, show all passengers where emergency and safety equipment is stowed, and explain how to use it. Everyone aboard should wear rubber-soled shoes which resist slipping on wet surfaces. While underway, passengers should remain seated inside the deck rails and gates. Do not allow passengers to drag their feet or hands in the water.

Always use handholds and other safety hardware to prevent falls. All nonswimmers, poor swimmers and small children should wear PFDs at all times.

#### D. Propeller



##### Personal Injury!

*Do not allow anyone near a propeller, even when the engine is off. Propeller blades can be sharp and continue to turn even after the engine is shut off. Do not allow anyone near the propeller when the throttle is in neutral position. Accidentally engaging the shift can result in a serious injury or death. (See actual ladder warning labels and helm boarding ladder warning label below).*



*Never approach or use ladder when motor is running. Severe injury or death will result from contact with rotating propeller.*

##### Ladder Warning Label



*Shut off motor when near swimmers. Severe injury or death will result from contact with rotating propeller.*

##### Helm Boarding Ladder Warning Label



*When pulling skiers do not turn on the engine until you are at least a boat length away from the person in the water. When approaching a downed skier, turn off the engine at least one boat length away before reaching the skier in the water.*

#### E. First Aid

As a boater, you should be familiar with the basic first aid procedures that may be needed while you are out far from help. Fish hook accidents or minor cuts and abrasions may be the most serious mishaps on board a boat but you should also learn the proper procedures and be ready to deal with the truly serious problems like mouth-to-mouth resuscitation, excessive bleeding, hypothermia, and burns. First aid literature and courses are available through most Red Cross chapters.

#### F. Operation By Minors

Minors should always be supervised by an adult whenever operating a boat. Many states have laws regarding the minimum age and licensing requirements of minors. Be sure to check local laws or contact the state boating authorities for information.

#### G. "Rules of the Road"

As a responsible boater, you must comply with the "Rules of the Road," the marine traffic laws enforced by the US Coast Guard. Navigating a boat is much the same as driving an automobile. Operating either one responsibly means complying with a set of rules intended to prevent accidents. Just as you assume other car drivers know what they are doing, other boaters assume you know what you are doing. Information regarding navigational rules and the "Rules of the Road" are discussed in further detail in C-1 & C-2 of the next section.

#### H. Voluntary Inspections

State boating officials in many states or the US Coast Guard Auxiliaries offer courtesy inspections to check out your craft. They will check for compliance with safety standards and required safety equipment. You may voluntarily consent to one of these inspections, and you are allowed to make corrections without prosecution. Check with the appropriate state agency or the Coast Guard Auxiliary for details.

#### I. Safe Boating Courses

The local US Coast Guard Auxiliary and the US Power Squadrons offer comprehensive safe boating classes several times a year. You may contact the Boat/US Foundation at 1-800-336-BOAT (2628) or, in Virginia, 1-800-245-BOAT (2628) for a course scheduled in your area. Also contact the US Coast Guard Auxiliary or Power Squadron Flotilla for the time and place of their next scheduled class.

#### J. Anchoring

The weight of the anchor and diameter of anchor line should be governed by the size and weight of your boat. Keep anchor secure while underway to prevent damage or injury due to sudden shifting in the boat's attitude.

Use two or more anchors if anchoring overnight or for extended periods. If not using two anchors, make

certain there is sufficient clearance for your boat to swing in a full circle to prevent damage in case of shifting winds.

Make certain you have enough anchor line (or scope) for the depth of water. Your anchor line should be 6 to 7 times the depth of water anchored in. For example, if you are in 20 feet of water, use 120 to 140 feet of anchor line.

 **CAUTION**

*Secure anchor line to bow eye or deck cleat. Never tie anchor line to a rail, rail fitting or other hardware not designed to support this stress.*

To drop anchor:

Approach your selected anchoring site from downwind and come to a dead stop over the spot where you want to drop anchor. Lower the anchor using the windlass foot switches at the bow or the WINDLASS switch at the helm.

Maneuver the boat slowly backwards until length of anchor line is 6 or 7 times the depth of the water.

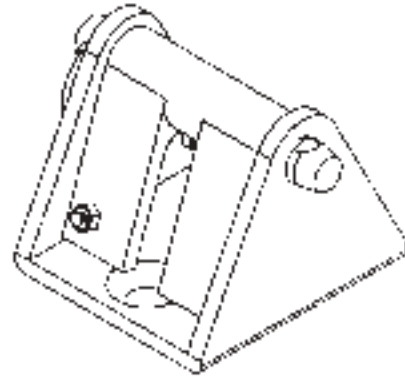
Fasten the anchor line around the bow eye or deck cleat. Anchor flukes should dig in and catch. Watch for anchor drag by checking shoreline landmarks at the time the anchor is dropped and one-half hour later. If the boat has drifted away from these reference marks, the anchor is dragging and must be reset.

To weigh anchor:

Start the engine before raising the anchor.

Slowly maneuver the boat forward to reduce tension on the line and make retrieval of the anchor line easier.

Raise the anchor using the windlass. Make sure the chain stop is engaged. See Figure B16. Should manual retrieval of the anchor ever be necessary be sure to properly stow anchor and anchor line.



**Figure B16: Chain Stop**

 **WARNING**

*Always be sure to raise and secure the anchor prior to operating your boat. Failure to raise and secure anchor before getting underway could result in severe injury or damage to boat from rebounding anchor.*

 **WARNING**

*Always utilize the chain stop provided with the windlass/bow roller combination. The chain stop prevents the anchor from accidentally releasing while the boat is moving thus preventing damage to the boat or possible injury or death to individual(s) aboard the boat.*

If the anchor becomes stuck, attach the vertical line to the mooring cleat. Wave action on the bow may lift flukes from the bottom and free the anchor. If the anchor is still stuck, feed out a few feet of line and attach it to the bow cleat. Maneuver the boat around the anchor, keeping the line firm. Determine the angle that will work to pull the anchor free.

Anchors are available in different shapes, sizes and weights to fit different boats, uses, and conditions. Your Four Winns dealer can tell you which anchor will work best for your boat.



## B - 4 WATER SPORTS



### PERSONAL INJURY

*Four Winns® boats are not designed for and should not be used for pulling parasails, kites, gliders or any device which can become airborne. Use boat only for appropriate water sports. (See Preface for actual warning label).*

Water skiing, wakeboarding, kneeboarding, or riding a towed, inflatable apparatus are some of the more popular water sports. Taking part in any water sport requires increased safety awareness by the participant and the boat operator. If you have never pulled someone behind your boat before, it is a good idea to spend some hours as an observer, working with and learning from an experienced driver. It is also important to be aware of the skill and experience of the person being pulled. Always have a second person on board to observe the person in the water so the driver can concentrate on operating the boat.

### A. Water Sport Guidelines

Everyone participating in a water sport should observe these guidelines:

1. Allow only capable swimmers to take part in any water sport.
2. Always wear a personal flotation device (PFD) approved by the US Coast Guard. Wearing a properly designed PFD helps a stunned or unconscious person stay afloat.
3. Be considerate of others with whom you share the water.
4. Give immediate attention to a person who has fallen. He or she is vulnerable in the water alone and may not be seen by other boaters.
5. Approach a person in the water from the lee side (opposite the direction of the wind). **Turn off the motor at least a boat length from the person.**
6. Turn engine off and anchor before swimming.
7. Always participate in water sports in safe areas. Stay away from other boats, beaches, restricted areas, swimmers and heavily traveled waterways.

8. Swim only in areas designated as safe for swimming. These are usually marked with a swim area buoy (see Figure B17). Do not swim alone or at night.



**Figure B17: Swim Area Buoy**



### Rotating Propeller!

*Rotating propeller can cut or sever causing serious injury or death. Shut engine off and remove ignition key when anyone is swimming nearby. (See Section B-3D).*

9. Do not allow anyone near the propeller(s), even when the engine is off. Propeller blades are sharp and can continue to turn even after the engine is off. Stay at least 150 feet away from areas marked by diver down float. See Figure B18.



**Figure B18: Diver Down Float**

10. Do not drive the boat directly behind a water skier. At 25 miles per hour, the boat will overtake a fallen skier who was 200 feet in front in about 5 seconds.

### B. Water Skiing/Wakeboarding/Kneeboarding

The popular sport of water skiing has brought a special set of safety precautions to observe in boating. The following guides help prevent accidents while water skiing.

1. Water ski only in safe areas, away from other boats and swimmers, out of channels, and in water free of underwater obstructions.

2. Allow no one who can not swim to water ski. Skiers must wear a USCG approved flotation device. A Type III water-ski vest is an approved and practical PFD.
3. Have a second person aboard to observe the skier and inform the driver about the skier's hand signals (Figure B19). The driver must give full attention to operating the boat and the waters ahead.
4. Give immediate attention to a fallen skier. Be careful not to swamp the boat while taking the skier on board.
5. Always participate in water sports in safe areas. Stay away from other boats, beaches, swimmers, and heavily traveled waterways.
6. Be considerate of others with whom you share the water.
7. Give immediate attention to a person who has fallen. He or she is vulnerable in the water alone and may not be seen by other boaters.
8. Approach a person in the water from the lee side (opposite the direction of the wind). Stop the motor at least a boat length from the person.
9. Turn off engine and anchor your boat before swimming.
10. Do not water ski between sunset and sunrise. It is illegal in most states.

**WARNING**

**Rotating Propeller!**

*Rotating propeller can cut or sever causing serious injury or death. Switch engine off before skiers enter the water and before taking skiers aboard. Do not leave engine running in neutral. Accidentally engaging shift can seriously injure skier.*

For more information about waterskiing, wakeboarding, and/or kneeboarding, please visit the American Water Ski Association, at their website: [www.usawaterski.org](http://www.usawaterski.org)

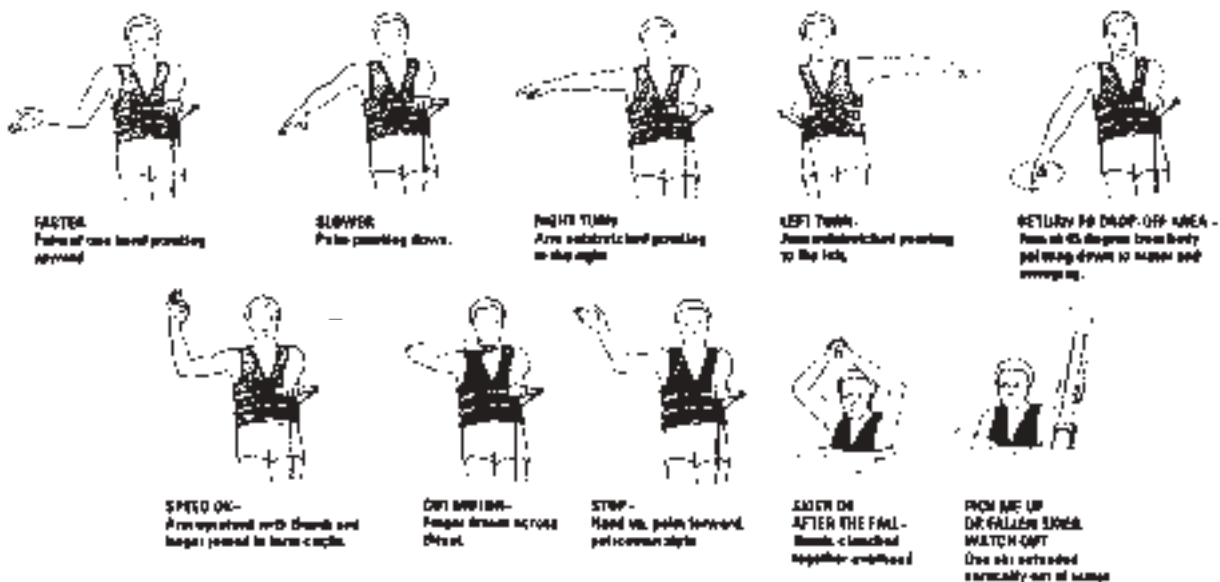


Figure B19: Skier's Hand Signals

## C - 1 GENERAL

Basic rules of seamanship, general information about navigational aids, and sources for additional reading and boater education are presented in this portion of your owner's manual.

### A. Boating Regulations

The US Coast Guard is the authority of the waterways. State boating regulations are enforced by local authorities. Your boat is subject to the marine traffic laws known as "Rules of the Road," which are enforced by the US Coast Guard. You are subject to marine traffic laws and "Rules of the Road" for both federal and state waterways; you must stop if signaled to do so by enforcement officers, and permit them to board if asked. The "Navigational Rules, International-Inland Rules of the Road" can be obtained from the US Coast Guard website at [www.uscgboating.org](http://www.uscgboating.org).

Many pamphlets prepared by the US Coast Guard are available. They explain signal lights, buoys, safety, international and inland regulations and other information which goes beyond the scope of this manual. "Aids to Navigation" (US Coast Guard pamphlet #123) explains the significance of various lights and buoys. Because of proposed alterations to buoys and markers, contact the US Coast Guard or visit their website to stay informed of changes. Other pamphlets, including the "Boating Safety Training Manual" and "Federal Requirements For Recreational Boats," are also available from the US Coast Guard.

#### NOTICE

The spoken word "MAYDAY" is the international signal for distress. "MAYDAY" should NEVER be used unless there is grave or imminent danger, and you are in need of immediate assistance.

### B. Rules of Seamanship

#### 1. Right-of-way

In general, boats with less maneuverability have right-of-way over a more agile craft. You must stay out of the way of the following vessels:

A vessel not under command or aground.	These vessels have no maneuverability.
A vessel restricted in its maneuverability.	These vessels are performing work which limits their maneuverability such as surveying, dredging, laying pipe or cable, servicing navigational markers among others.
A vessel engaged in fishing.	These include boats fishing with lines, trawl or nets; but not trolling lines.
Sailboats	Sailboats have the right-of-way over power boats; however, if a sailboat is using a propeller to move forward, it is considered a power boat even if its sails are up.

#### 2. Meeting Head-On

When two boats meet head-on neither boat has right-of-way. Both boats should decrease speed and pass; port to port. However, if both boats are on the left side of a channel, each vessel should sound two short horn blasts and pass to starboard to starboard. See Figure C-1.

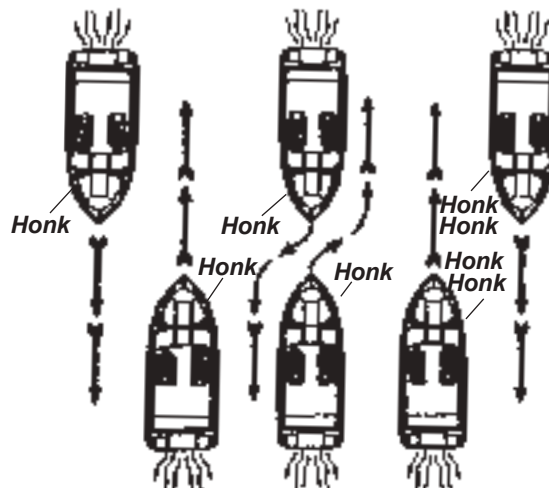


Figure C-1: Meeting Head-On

#### 3. Crossing Situations

In a crossing situation, the boat on the right from the 12-4 o'clock position has the right-of-way. It must hold course and speed. The boat without the right-of-way must keep clear and pass to the stern. See Figure C-2.

Stand-on (Privileged) Vessel holds course and speed

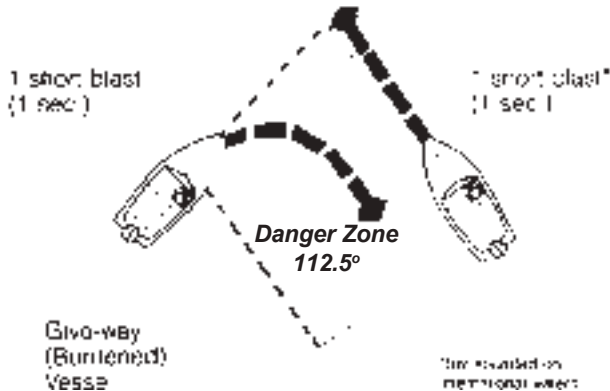


Figure C-2: Crossing Situation

#### 4. Overtaking

The boat overtaking the one ahead must yield the right-of-way to the boat being passed. The overtaking boat must make necessary adjustments to keep out of its path. The boat being passed should hold its course and speed. See Figure C-3.

Inland Rules	Stand-on (Privileged) Vessel Being Overtaken	Inland Rules
"I want to pass you on your port side."		"I want to pass you on your starboard side."
2 short blasts (1 sec.)		1 short blast (1 sec.)
"Proceed"		"Proceed"
2 short blasts (1 sec.)		1 short blast (1 sec.)
International Rules		International Rules
"I am altering my course to port."		"I am altering my course to starboard."
2 short blasts (1 sec.)		1 short blast (1 sec.)
International Rules in Narrow Channels		International Rules in Narrow Channels
"I intend to pass you on your port side."		"I intend to pass you on your starboard side."
2 prolonged blasts (4-6 sec.)		2 prolonged blasts (4-6 sec.)
2 short blasts (1 sec.)		1 short blast (1 sec.)
"Proceed."		"Proceed."
1 prolonged, 1 short		1 prolonged, 1 short
1 prolonged, 1 short		1 prolonged, 1 short blast

Figure C-3: Overtaking

#### 5. The General Prudential Rule

The general prudential rule regarding right-of-way is that if a collision appears unavoidable, neither boat has right-of-way. As prescribed in the "Rules of the Road", both boats must act to avoid collision.

#### 6. Night Running

Boats operating between sunset and sunrise (hours vary by state), or in conditions of reduced visibility, must use navigational lights. Nighttime operation, especially during bad weather or fog, can be dangerous. All "Rules of the Road" apply at night, but it is best to slow down and stay clear of all boats regardless of who has right-of-way.

To see more easily at night, avoid bright lights when possible. Also, it is helpful to have a passenger keep watch for other boats, water hazards, and navigational aids.

To determine the size, speed and direction of other vessels at night, you should use running lights. A green light indicates the starboard side, and the red light indicates the port side. Generally, if you see a green light, you have the right-of-way; if you see a red light, give way to the other vessel. See Figure C-4.

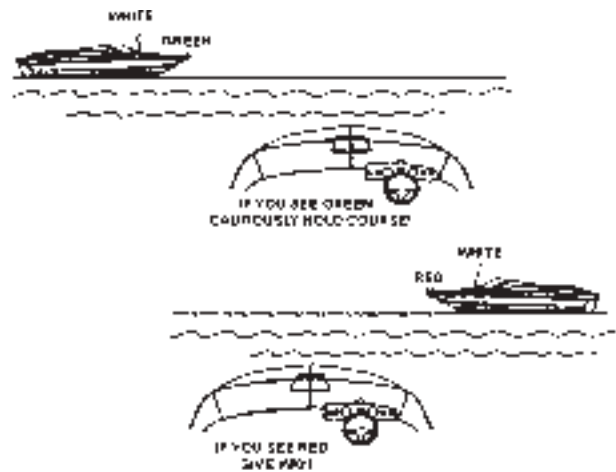


Figure C-4: Night Running

#### 7. Whistle Signal

Out on the water, whistle signals are commonly used. Although using a whistle signal is not necessary every time a boat is nearby, operators must signal their intentions when necessary to avoid potentially confusing or hazardous situations. Use whistle blasts early enough to be noticed and understood by other boaters.

It is customary for the privileged boat to signal first and the yielding boat to return the same signal to acknowledge she understands and will comply. Use the danger signal (five or more short and rapid

blasts) if intent is not clear. A short blast is one or two seconds long. A long blast is 4 to 6 seconds long. The Navigational Aids Chart at the end of this section lists the meanings of the various whistle signals.

## C - 2 NAVIGATIONAL AIDS

Aids to navigation (ATONS) help you to travel safely on the water. They help you get from one place to another and are most helpful if you have a nautical chart. A navigational aids chart is at the end of this section.



*NEVER tie your vessel to an ATON. It is illegal because it blocks the ATON from view of other boaters. Decreased visibility can contribute to a serious accident which may result in property damage, personal injury, or death.*

There are two ATON systems. The system used on federal waters is known as the International Association of Lighthouse Authorities System B (IALA-B). The Coast Guard maintains this system. The second system is the Uniform State Waterway Marking System (USWMS). This system is maintained by state authorities.

### A. International Association of Lighthouse Authorities System B (IALA-B)

IALA-B uses four types of ATONS. This section discusses the two most common markers: lateral markers and safe water markers. Other federal markers include special markers and isolated danger markers. The Navigational Aids Chart at the end of this section shows these aids.

### B. Lateral Markers

#### NOTICE

Marker colors only apply in North America.

Lateral markers indicate the sides of navigable channels. They consist of lighted can or nun buoys and daymarks. Each has a number and is either red or green. The numbers on the green markers are odd. Red markers have even numbers.

Buoys are red or green floating ATONS. If lighted, they have either red or green lights. Unlighted green buoys, called cans, look like cylinders. Unlighted red nun

buoys have a cone shaped top with their points cut off. Do not pass too close to a buoy. You may foul the propeller in its chain.

#### NOTICE

*Buoys are anchored floating objects and may not always be in exactly the same position.*

Daymarks are red or green boards with numbers. They are on posts or groups of pilings tied together and called dolphins. Daymarks and their supports are daybeacons. Daybeacons may or may not have lights. If a red or green daybeacon has a light, it is the same color as the marker-red or green. Red daymarks are triangular and have even numbers. Green daymarks are square and have odd numbers.

**Red Right Returning** is a basic rule to assist you in using lateral markers. When you are returning from seaward, keep red markers on the starboard (right) side when you pass them. Keep green markers to the port side.

Returning from seaward is very clear if you have been on the ocean. You are returning to port. By agreement, going upstream on a navigational river is returning from seaward. The outlet ends of the Great Lakes are also the seaward ends. Traveling from a large body of water to a smaller one is considered returning from seaward.

### C. Safe Water Markers

Safe water markers have vertical red and white stripes and mark the center of navigable channels and fairways. Safe water markers included both lighted and unlighted buoys and daymarks. If a marker is lighted, the light is white and flashes the letter "A" is Morse Code.

Preferred Channel markers have horizontal red and green bands. If lighted, the color of the light is the same as the top of the band. They show the preferred channel for you to use at a junction point. Be sure to notice the color of the top of the band, and treat it as any other marker you would of that color. If the band is red and you are returning from seaward, keep the marker to the right.

Most lights on markers flash on and off. Others such as lights on aids with no lateral significance are fixed. They stay on all night. ATON lights flash in regular patterns. For example, they may flash every three



seconds, or in groups such as two flashes and a pause. There are a number of flashing patterns, which help you identify the light at night. To identify a light, note its color and pattern or timing of flashes, and compare it to your chart to find its location.

#### **D. The Uniform State Waterway Marking System**

This section discusses three kinds of markers in this system: Regulatory, Informational, and Lateral.

Regulatory markers in this system are either signs or buoys. Signs are square with orange borders. Regulatory buoys are white and shaped like cylinders. They have horizontal orange bands near their tops and just above the water's surface. An orange circle on a marker means a controlled area. A message such as "No Wake, Idle Speed, No Skiing, or 5 M.P.H." may appear on a marker. An orange diamond means danger. If a diamond has an orange cross inside it, do not enter the area. The reason you should stay out, such as "Swim Area" may be printed in black on the marker.

Informational Markers are white signs with orange borders. They give information such as direction, distance, and location.

Lateral markers in the USWMS system are either numbered red or black buoys. Black buoys may have green reflectors or lights. They are the equivalent of green buoys in the IALA-B system. Red buoys may have red reflectors or lights. They are the same as red buoys in the IALA-B system. Red or black buoys are usually found in pairs – pass between them.

#### **E. A Special Sign**

In Florida, you may see a special sign: "Caution, Manatee Area". When you see this sign, slow down to idle speed. Manatees, an endangered species, are passive, large, slow-moving mammals. Many manatees are seriously injured or killed each year by boat propellers.

#### **F. Noise**

Always be aware of local laws on noise limits. Noise means engine noise, radio noise or even yelling by people on your boat. Good seamanship demands that you operate your boat quietly so as not to infringe on the rights of others. Do not use thru-hull exhaust unless you are well offshore.

### **C - 3 RECOMMENDED READING**

We recommend that you read the boating literature published by your state boating agency and the US Coast Guard. Other suggested reading includes the following:

Damford, Don. Anchoring. (ISBN 0-915160-64-1). Seven Seas.

United States Coast Guard Auxiliary. Boating Skills and Seamanship. LC74-164688.(illus.). (ISBN 0-930028-00-7). US Coast Guard.

Bottomley, Tom. Boatman's Handbook, (illus.). 316 p. (ISBN 0-688-03925-1, Hearst Marine Book). Morrow.

Whiting, John and Bottomley, Tom. Chapman's Log and Owner's Manual. 192 p.(ISBN 0-686-96737-2). Hearst Marine Book.

Chapman, Charles F. and Maloney, E.S. Chapman's Piloting, Seamanship and Small Boat Handling. (illus.). 62 p. (ISBN 0-87851-814-2, Pub. by Hearst Bks.); deluxe ed. (ISBN 0-87851-815-0). Morrow.

National Fire Protection Association. Fire Protection Standard for Pleasure and Commercial Motor Craft. (ISBN 0-317-07388-5, NFPA 302). National Fire Protection Association.

Brotherton, Miner. Twelve-Volt Bible. (ISBN 0-915160-81-1). Seven Seas.

### **C - 4 CONTACTS**

There are many good boating publications that have information about your area and what other boats are doing, such as clubs and other activities. Educational programs are sponsored by publications and organizations such as the US Power Squadron, US Coast Guard Auxiliary and the American Red Cross. See your dealer about special courses available in the area. For detailed information contact:

American Red Cross  
Local address (see local telephone directory)  
website: [www.redcross.org](http://www.redcross.org)

Boat US Foundation for Boating Safety  
1 800-336-BOAT  
website: [www.boatus.com/courseline](http://www.boatus.com/courseline)

US Coast Guard Info Line  
1 800 368-5647

Skippers Course  
GPO Superintendent of Documents  
Washington, DC 20012  
202 512-1800  
202 512-2250 (fax)

United States Coast Guard Auxiliary  
Local Flotilla or contact appropriate Coast Guard  
District Headquarters  
website: [www.cgaux.org](http://www.cgaux.org)

United States Coast Guard Headquarters  
2100 2nd St., SW  
Washington, D.C. 20593-0001  
202 267-1060  
website: [www.uscgboating.org](http://www.uscgboating.org)

United States Power Squadron  
P.O. Box 30423  
Raleigh, NC 27617  
website: [www.usps.org](http://www.usps.org)

## C - 5 OWNER'S LOGS AND RECORDS

At the end of this owner's manual are several forms which you will find very helpful.

The **Float Plan** provides a record of your destination, departure and return times, boat description, passenger list, and other information about the trip you have planned. At the bottom of the form is space for listing emergency telephone numbers in case your return is delayed past the expected time. It also has space for indicating information about the person filing this report. Leave the completed form ashore with a responsible person. We recommend you make several copies of this form each boating season to assure an ample supply.

The **Fuel Log** is a handy way to record information covering engine hours, fuel consumption, miles traveled, as well as RPM (revolutions per minute), average MPH (miles per hour) and GPH (gallons per hour).

The **Service/Maintenance Log** provides a record of maintenance work completed, the date of completion, and the engine hour reading. This log also helps you identify the frequency of routine maintenance work, such as engine oil changes. If you should decide to sell your boat, it demonstrates to prospective buyers that you have done a good job taking care of it.

The **Service Information Sheet** allows you to record all the pertinent information regarding your Four Winns® boat. This sheet will be extremely helpful when ordering additional/optional parts for your boat or when having service work done.

## C - 6 NAVIGATIONAL AIDS CHART

The illustrated Navigational Aids Charts contain information concerning whistle signals, storm warnings, bridge signals, and buoy descriptions. See the inside back cover of this manual.



### **D - 1 FOUR WINNS WARRANTY POLICY**

The Four Winns Winning Edge™ Owner Protection Plan provides the new Four Winns purchaser with one of the most comprehensive corporate commitments in the marine industry today. The Winning Edge™ Owner Protection Plan defines the warranty coverage on all units manufactured by Four Winns. It thoroughly describes the warranty policies and those procedures to be followed to obtain warranty coverage. Review the Four Winns Owner Protection Plan and limited warranty statements carefully.

All engines utilized in the Four Winns® product are warranted by the engine manufacturer. Your Four Winns dealer is authorized to repair your engines and will work closely with the engine manufacturer to resolve any problems you have.

### **D - 2 DECK/HULL STRUCTURE WARRANTY**

Each unit manufactured by Four Winns is encompassed by a separate warranty providing specific coverage on the deck/hull structure. The Winning Edge™ Owner Protection Plan thoroughly describes this coverage.

### **D - 3 WARRANTY REGISTRATION**

A Four Winns Warranty Registration Card is attached to the Winning Edge™ Owner Protection Plan statement. Your Four Winns Dealer is responsible for completing and mailing the warranty card at the time of purchase. The receipt of the warranty card is the sole basis for establishing proof of ownership of the boat and corresponding warranty validation.

By signing the warranty registration card you, the new owner, indicate an understanding of the terms and conditions of the Limited Warranty. The warranty registration card should be properly completed by the dealer, signed by the new owner, and returned to us within fifteen (15) days after the original purchase in order to validate the warranty. This is a dealership's responsibility. Be sure to keep the Owner's Registration Card for your records. The preferred registration method is completed online by the dealer.

All boat manufacturers are required by The Federal Boat Safety Act of 1971 to notify first time owners in the event any defect is discovered "which creates a substantial risk of personal injury to the public." In order for us to notify you if necessary, be sure to verify the accuracy of the embossed Winning Edge™ card upon

receipt. You should receive your Winning Edge™ card within approximately 30 days from the day of your boat purchase. If you have not received your Winning Edge™ card within this time frame please contact your Four Winns selling dealer for resolution. If upon receipt of the card you discover a discrepancy, please notify Four Winns at 231 775-1343. A corrected Winning Edge™ card will then be sent to you.

Other equipment manufacturers also require that their products be registered with the respective companies. Warranty registration cards are provided in the owner's information packet.

### **D - 4 TRANSFER OF WARRANTY**

Four Winns' confidence in the product and our warranty commitments can extend after the original purchaser may choose to move on to a new boat. The remainder of the Four Winns warranty coverage is transferable to the second owner of the boat for a fee. The warranty may be transferred only once. Registration of the second owner is required and the amount of the transfer fee is indicated on the warranty statement of the Warranty Registration Card. Transfer of the remainder of the warranty must occur within five (5) years of the original retail sale. The transfer fee must be paid within fifteen (15) days of purchase of the used boat by check, money order or cashier's check payable to Four Winns, L.L.C. Proof of purchase date is required. The Winning Edge™ Owner Protection Plan thoroughly describes the action required to transfer warranty coverage.

### **D - 5 PRE-OWNED UNIT REGISTRATION**

Section E-4 Transfer of Warranty discusses the need to properly register the purchase of a pre-owned boat with Four Winns in order to transfer applicable warranty coverage.

Purchasers of all Pre-Owned Four Winns models, regardless of the decision to transfer warranty coverage, are encouraged to register ownership with Four Winns. To register ownership of a "Pre-Owned Four Winns® boat," provide Four Winns with your name, address, daytime phone number, e-mail address, purchase date, and hull serial number of the boat purchased. The hull serial number plate is permanently affixed to the starboard side of the transom. Registration of a Pre-Owned Four Winns® boat does not extend or in any way affect or modify the specific

terms of the Winning Edge™ Owner Protection Plan or Limited Warranties. We provide this service to the purchasers of Pre-Owned Four Winns® boats in the interest of better boating. Four Winns welcomes every purchaser of a Four Winns® boat, new or used, to our family.

## **D - 6 INSURANCE COVERAGE**

One of your responsibilities as a new boat owner is to acquire proper insurance protection. Insurance should include comprehensive and general liability coverage appropriate to your financial needs. Please contact your local agent for assistance on insurance coverage.

## **D - 7 SERIAL NUMBER RECORD**

The manufacturer, model, and serial number of major components are recorded during the assembly of each Four Winns® boat. A copy of this form is included in the owner's packet. Using this form, you may want to have your dealer help you complete the service information form at the back of this manual. A copy of the serial number record should be made and kept by the dealer in his records. This can assist the dealer in processing warranty claims, or obtaining necessary information. The original copy of the serial number record should be kept in the owner packet. The service information form should remain in the owners manual for easy reference.

## **D - 8 PRE-DELIVERY SERVICE**

Four Winns makes every effort to deliver your boat in "turn key" condition to the dealer. The process of transporting and handling the boat necessitates certain inspections and adjustments prior to delivery to you. Also, various aspects of operation must be checked and adjusted immediately prior to final delivery and use.

The selling Four Winns dealer must perform this thorough review of the boat and its numerous systems during the commissioning or "dealer pre-delivery service" of the craft.

A Four Winns Pre-Delivery Inspection Form is part of the Warranty Registration Card. It lists the many items encompassed by the pre-delivery service previously described. The dealer is to check off the items as they are completed, and complete the form as indicated providing specific performance related information appropriately.

Your Four Winns dealer will sign the Pre-Delivery Inspection Form of the Warranty Registration Card upon completion of the work. You will also be asked to sign the Pre-Delivery Inspection Form upon accepting delivery of the boat. You are to retain the two copies marked "Boat Owner". Your dealer is to retain the copy marked "Dealer copy" for his records. The Manufacturer's copy is electronically sent to the Four Winns Customer Service Department.

## **D - 9 REPLACEMENT PARTS**

Four Winns dealers are equipped with a Four Winns parts manual that details the components of each model and their appropriate part numbers. Many Four Winns dealers inventory common replacement components.

In addition, Four Winns maintains specific records on the components used in the manufacture of each unit and makes a concerted effort to maintain components specifically to fill replacement part needs.

The Four Winns dealer from whom you purchased your boat is in the best position to meet your needs. If the dealer does not have the needed item, the dealer has the capability, through direct contact with the Four Winns Customer Service Department, to obtain it quickly. Four Winns will only sell replacement parts to established Four Winns dealers. If you relocate and cannot find a Four Winns dealer close to you, contact the Four Winns Customer Service Department for information on the nearest dealer in your area.

## **D - 10 OWNER'S RESPONSIBILITIES**

1. Sign the warranty registration card verifying your address, model and hull serial number. The dealer is responsible for mailing the warranty registration card to us.
2. Inspect the boat at the time of delivery to verify that all systems and components are operating safely and acceptably. Read all manuals and instructions.
3. Operate all equipment in compliance with the manufacturer's instructions.
4. Review the pre-delivery checklist for the boat and engine with your dealer when you take delivery.

5. Schedule your 20-hour boat and engine checkup with your dealer.
6. Know how to safely operate your boat and the rules of the road before you use your boat.

**IMPORTANT:** Make sure that your dealer checks the engine alignment during your boat's 20-hour checkup. The engine alignment check should be performed in accordance with recommended procedures as stated by the engine manufacturer in your engine owner's manual. Failure to do so could result in drive train damage which is not covered under the warranty.

7. We recommend that you review your engine owner's manual and warranty certificate for break-in advice, initial inspection and service requirements.
8. Perform or provide for the scheduled maintenance checks outlined in this manual and all related service guides and manuals.
9. You are responsible for any modifications made to the boat or its equipment that could affect the safe operation of the boat.

Along with boating, comes responsibility. Responsibility for safety, boating laws, and the environment. Please think about the future of our waterways, oceans and marine life while you're out enjoying them and take all necessary measures to help protect what natural habitats we have left. Keeping our waterways and marine habitats free from debris, and showing consideration for the creatures who thrive in these environments are some ways you can help assure the pleasure of boating for years to come.

The operator is also responsible for complying with the following procedures and operational requirements:

- State registration
- Insurance
- Warranty registration
- Warranty terms and conditions
- Rules of the road
- Break-in procedure
- Proper maintenance of the boat and its systems
- Safety equipment
- Safety training of passengers and crews
- Knowledge of boat systems
- Seaworthiness/operational inspection
- Safe operating practices
- Avoiding use of drugs/alcohol

- Environmental regulations
- Accident reporting

## **D - 11 CONSTRUCTION STANDARDS**

All Four Winns® boats meet or exceed the construction standards set by the US Coast Guard and the American Boat and Yacht Council (ABYC) concerning:

- Navigational lights
- Factory-installed fuel systems
- Engine and fuel tank compartment ventilation
- Flotation
- Steering systems
- Backfire flame arresters

We recommend that you see your dealer if you wish to modify factory-installed equipment or add new equipment. Your dealer is qualified to make such modifications or additions without placing the safety or design integrity of your boat at risk and without invalidating the warranty.

## **D - 12 WINNGEAR**

Show your colors! Four Winns offers a complete line of sports clothing designed to complement your new boat. The WinnGear™ line is on display on our website at [www.fourwinns.com](http://www.fourwinns.com).





Please place in envelope and mail to: Four Winns  
925 Frisbie Street | Cadillac, MI 49601



## NAME / ADDRESS CHANGE FORM

Name & Address:

*Please print clearly.*

---

---

---

---

Telephone & E-Mail Address:

---

Hull Identification Number:

---

Boat Model:

---

Date of Purchase:

---

NOTE: For warranty transfer please use the Warranty Transfer Request Form also included in this manual.



## NAME / ADDRESS CHANGE FORM

Name & Address:

*Please print clearly.*

---

---

---

---

Telephone & E-Mail Address:

---

Hull Identification Number:

---

Boat Model:

---

Date of Purchase:

---

NOTE: For warranty transfer please use the Warranty Transfer Request Form also included in this manual.



## NAME / ADDRESS CHANGE FORM

Name & Address:

*Please print clearly.*

---

---

---

---

Telephone & E-Mail Address:

---

Hull Identification Number:

---

Boat Model:

---

Date of Purchase:

---

NOTE: For warranty transfer please use the Warranty Transfer Request Form also included in this manual.

Please place in envelope and mail to: Four Winns  
925 Frisbie Street | Cadillac, MI 49601





FOUR WINNS L.L.C., 925 Frisbie Street, Cadillac, MI 49601 Phone (231) 775-1343

## WARRANTY REGISTRATION TRANSFER REQUEST

Original Owner Name & Address:

---

---

---

Original Date of Purchase:

---

Hull Identification Number:

---

Boat Model:

---

Selling Dealer:

---

Name and address of new purchaser:

---

---

---

Telephone & E-Mail Address:

---

Date of Purchase:

---

The warranty may be transferred only once. Registration of the second owner is required and the amount of the transfer fee\* is indicated on the warranty statement of the Warranty Registration Card. Transfer of the remainder of the warranty must occur within five (5) years of the original retail sale. The transfer fee must be paid within fifteen (15) days of purchase of the used boat by check, money order or cashier's check payable to Four Winns, L.L.C.

This warranty registration request if accepted, transfers the warranty coverage remaining on the boat to the new purchaser. Acceptance of this request does not create any additional warranties or obligation on Four Winns.

Warranty Expiration Date:

---

Four Winns Transfer Acceptance Date:

---

Four Winns Authorized Signature:

---

Mail to Four Winns, L.L.C., 925 Frisbie Street, Cadillac, MI 49601, Attn: Customer Service Department.

**\*Subject to change without notice.**





**E - 1 GENERAL**


*DO NOT attempt to service any engine without being totally familiar with the safe and proper service procedures. Do not attempt to maintain or adjust an engine while it is running. Certain moving parts are exposed and failing to shut off the engine can result in serious injury or death.*

Four Winns does not manufacture engines or drives. Because of the technical nature of the engine and drive systems, all manufacturers of these items require that warranty and service problems be taken directly to an authorized dealer for resolution. The Four Winns dealer from whom you purchased your boat, will handle all warranty and service matters with the engine manufacturer for you.

In compliance with the Federal Boat Safety Act of 1971 all engine manufacturers require their products to be registered. A registration card is furnished with each new engine. When selling a Four Winns® boat, the dealer, along with the purchaser, should complete the information requested on these cards and return them to the respective engine manufacturers. Engine registration cards are provided with the engine and will usually be found with the boat literature.

Each manufacturer of the various marine power components provides an owner's operator's manual with their product. This publication is included with this manual. It is important that you read the manual(s) carefully and become completely familiar with proper care and operation of the engine and drive system. Be sure to read the section on winterization. Replacement costs associated with frozen engine blocks, drive systems and other components are quite substantial.

Also review the other sections in this manual, especially Sections I on Fuel Systems, and Section F on Control Systems.

**E - 2 ENGINE EXHAUST**
**A. Carbon Monoxide**

The carbon monoxide in exhaust fumes can be hazardous. It is important for you and your passengers to be aware of the potential safety hazard

created by exhaust fumes. Familiarize yourself with the symptoms of individuals overcome by carbon monoxide, and most importantly, ways you can protect yourself and your guests.



*DO NOT inhale exhaust fumes! Exhaust contains carbon monoxide which is colorless and odorless. Carbon monoxide is a dangerous gas that is potentially lethal.*

*Persons overcome by carbon monoxide may exhibit the following symptoms:*

- a. *Watering and itchy eyes*
- b. *Flushed appearance*
- c. *Throbbing temples*
- d. *Inattentiveness*
- e. *Inability to think coherently*
- f.  *ringing in the ears*
- g. *Tightness across the chest*
- h. *Headache*
- i. *Drowsiness*
- j. *Incoherence*
- k. *Nausea*
- l. *Dizziness*
- m. *Fatigue*
- n. *Vomiting*
- o. *Collapse*
- p. *Convulsions*

***IF YOU THINK EXHAUST FUMES ARE ENTERING YOUR BOAT, DETERMINE THE CAUSE AND HAVE IT CORRECTED IMMEDIATELY!***

The following suggestions can help prevent exhaust fumes from entering the boat or injuring people in the vicinity:

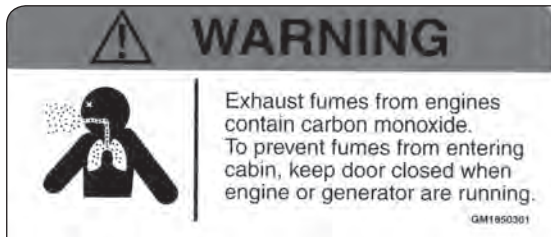
1. **DO NOT** allow the boat to remain stationary with the engines running for an extended period of time. Do not stand or swim near the exhaust output or drives when the engine is idling.
2. Use extreme caution while operating the engines in confined areas such as enclosed slips, congested piers, or in any area where the exhaust outlets are facing or near a bulkhead or wall structure of any kind. Operation under such conditions could easily lead to exhaust gasses (carbon monoxide) entering even though you may have all the hatches, windows, doors and portholes closed.

3. Never operate your generator while the boat is moored against any other boat, dock or wall structure that is against or near the exhaust outlet. Again, operation under such conditions could easily lead to exhaust gases (carbon monoxide) entering your boat or the boat to which you are moored, even though you may have all the hatches, windows, doors, and portholes closed.
4. Under certain conditions, exhaust gases can enter the boat through the sink drains. Each sink drain has a water trap installed to help prevent this. To be effective, the sink drains must have water in them. Normal use of the sinks will provide the water needed for this to occur.
5. Persons sleeping can be easily overcome by carbon monoxide because they are unaware of its presence. Sleeping with the engines or generator running is not recommended. If persons are sleeping aboard while underway, or while the generator is running, those awake should monitor for carbon monoxide accumulation in the cabin; especially the sleeping areas. Open forward facing windows or deck hatches to provide fresh air ventilation. Keep hatches, windows, and doorways that face aft or towards the exhaust discharge closed.

 **WARNING**

*NEVER operate the propulsion engine(s) or generator while everyone on board is sleeping. Fatal carbon monoxide poisoning can occur.*

6. If possible, ventilate your cabin while under way. Open a forward hatch or window to allow air to travel through the cabin. Do not operate the boat with the cabin door(s) or windows that face aft, open. The natural vacuum created during operation may allow exhaust gasses to be drawn into the cabin.



**Carbon Monoxide - Cabin Doors Warning Label**

**NOTICE**

*The forward deck hatch, portlights and port and starboard windows are designed to allow ventilation when placed in open position.*

7. Inspect the engine exhaust system frequently for water and exhaust gas leakage, hose deterioration, and loose hose clamps. See Section R - General Maintenance for additional information.
8. Have a certified marine engine service technician inspect your exhaust system whenever your boat is in for service, or if you notice a change in the sound of your engines.

For additional information, refer to Section B-2 - Carbon Monoxide.

**B. Carbon Monoxide Monitor**

A carbon monoxide (CO) monitor(s) will sound an alert should carbon monoxide reach an unsafe level in the cabin of your V475. The CO Monitors are standard equipment and are located in the aft cabin, forward cabin and main cabin. Refer to the manufacturer's literature included with the owner's packet.

 **WARNING**

*Never disarm a CO detector. If a CO detector alarms, immediately ventilate the area and check passengers for symptoms of CO intoxication. See your Four Winns dealer for assistance in diagnosing the cause for the alarm.*

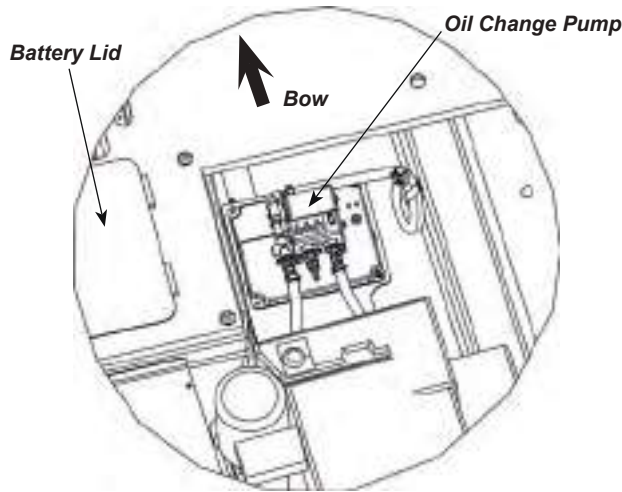
**E - 3 ENGINE & DRIVE SYSTEM**

**A. Engine**

The V475 model is equipped with twin IPS diesel engine propulsion. Please consult the engine operator's manual provided with this manual for operation and maintenance information.

**Note:** With regard to engine maintenance, an oil change pump system has been installed in the engine compartment. See Figure E1 and the locator drawing at the back of this manual. This oil change pump system is designed to drain and fill the oil levels in your engines while eliminating the mess.

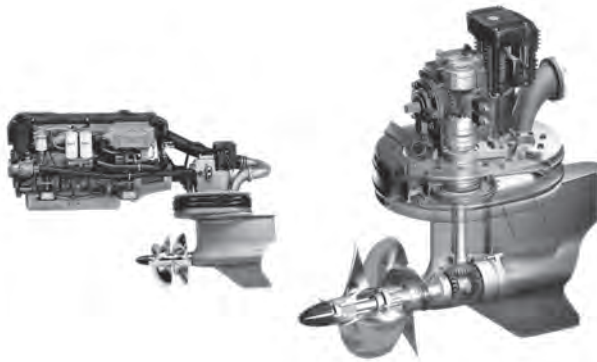
Consult the engine operator's manual and the oil pump manufacturer's manual provided in the owner's packet for specific information.



**Figure E1: Oil Change Pump**

### B. Volvo Penta IPS Drive-Units

The Volvo Penta Inboard Performance System (IPS) has twin drive-units that are steerable. These drive-units turn and point the entire thrust in the desired direction. The drive-units can be steered independently of one another. Each drive-unit is coupled to its respective diesel engine and shifting is performed within the drive-unit. The drive-units are mounted through the hull at the stern. This type of system is depicted in Figure E2.



**Figure E2: Volvo Penta IPS Drive-Unit**

#### NOTICE

To go from FORWARD to REVERSE, or REVERSE to FORWARD; always pause at NEUTRAL and allow engine speed to return to idle. **NEVER** shift the unit while engine speed is above 1500 rpm.

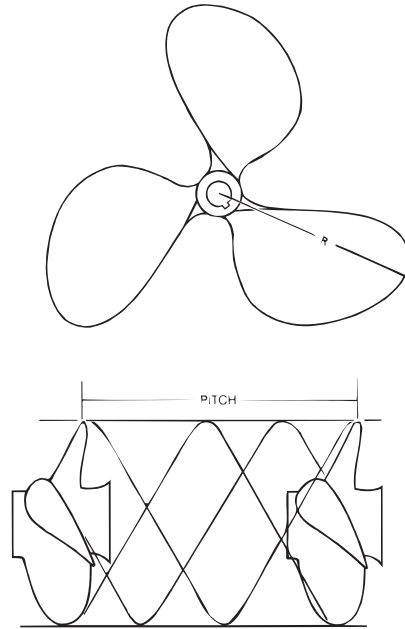
## E - 4 PROPELLERS

Knowledge of the propeller is most easily gained through better understanding of the terminology used to refer to the aspects of propeller size and performance. It should be noted the V475 models include two counter-rotating Nibral propellers on each propulsion unit..

### A. Diameter

Diameter is twice the distance from the center of the prop shaft to the extreme tip of a propeller blade. Increasing or decreasing propeller size will have a direct bearing on the RPM's an engine will develop.

This is due to the greater amount of propeller blade surface in contact with the water. See Figure E3.



**Figure E3: Propeller Pitch & Diameter**

### B. Pitch

Pitch is a measure of helix angle, or angle of attack, of the rotating blade. Pitch is easily understood if one imagines the propeller rotating through a semisolid such as butter or gelatin. The distance the propeller will travel in one revolution is called "Pitch." Increasing or decreasing pitch will also have a direct bearing on engine RPM's because of the greater bite taken by the blade with each rotation. See Figure E3.

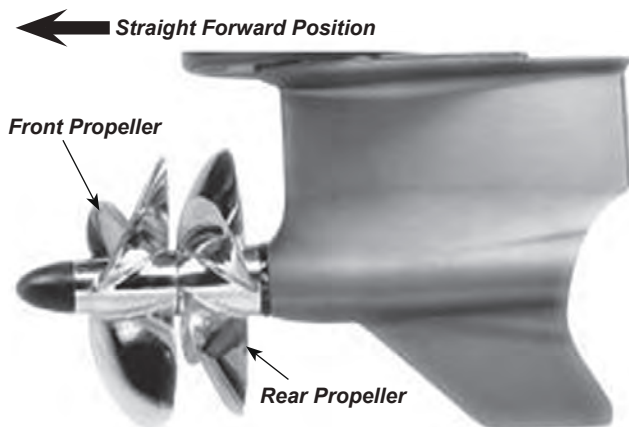
### C. Prop Slip

When traveling through water a propeller is unable to get a complete bite because of the fluidity of water. "Prop slip" is usually expressed as a percent of the computed theoretical speed. Twenty-five to thirty-five percent prop slip is common for a cruiser-type boat operating at cruising speed.

Changing either diameter or pitch will have an effect on engine speed and prop slip, and in turn, directly effect the performance of a boat. The propellers included with each Four Winns® boat provide the best general performance based on data obtained from on-the-water testing of that model. Variations in load, operating conditions, environment, the individual engine and hull performance may necessitate the purchase and use of another propeller(s). Under your normal load conditions, the engines should turn within the maximum RPM range when at full throttle. If the engines exceed the recommended RPM, an increase in pitch or diameter is required. If the engine RPM is too low, a decrease in pitch or diameter is required.

The load carried in a boat will directly affect performance of the engine. If an engine that is not developing full power, be sure the engine is properly tuned and load conditions are those normally experienced, before changing propellers.

For shipping reasons, the propellers are not factory installed. Initial installation of the propellers will be performed by the dealer during pre-delivery service. Consult your specific engine manufacturer's owner's manual for propeller installation instructions. See Figure E4.



**Figure E4: Counter-Rotating Propellers**

### NOTICE

*Should it be necessary to change propellers, always use an appropriate propeller removal tool or "Prop Puller." DO NOT attempt removal using a hammer. Damage to the propeller or propeller shaft can result.*

Be sure the propellers are of the correct blade configuration, diameter, pitch, and shaft size to assure good performance. For additional information on factors affecting performance and/or assistance with your selection, please consult your Four Winns dealer.

## E - 5 COOLING SYSTEMS

### A. Fresh Water Cooling System

The fresh water system is the engines' internal cooling system. The freshwater cooling system ensures the engine operates at the correct temperature. It is a "closed water cooling" system and **must** be filled with a mixture of at least 40% concentrated coolant and 60% water to protect against internal corrosion, cavitation and damage caused by freezing. This system provides adequate engine cooling without exposing the internal engine to the detrimental effects of surface water, including salt, highly polluted or silt-laden water. The engine owners manual provides additional information regarding service and maintenance of this equipment. See your Four Winns dealer for availability.

### WARNING

*Should an engine intake or an exhaust or cooling hose rupture, turn the engine off and close the seacock immediately. Proceed under tow, if necessary, to a service facility for appropriate repairs; maintain a close visual watch on the problem hose and also on the bilge water level.*

### B. Seawater Cooling System

The seawater system is the boat's external cooling system. Surface water is used a cooling medium for the control system oil cooler, fuel cooler, intercooler, engine oil cooler and heat exchanger. The cooling water employed enters the system through a water intake on the drive-unit and is relinquished through the exhaust pipe elbow where it is mixed with the exhaust gases. Some boating areas require that additional



water intake filters be installed. Reference Section P-3 - Equipment Installation, in this manual for installation instructions and consult your Four Winns dealer regarding any special equipment that may be required.

 **CAUTION**

*Never operate your engine without a thermostat. Engine damage can occur and is considered operator negligence and therefore not covered under the engine warranty.*

 **CAUTION**

*If engine should overheat, turn off engine, look for obstructions to water pick-up. If any obstructions are found, clear the obstructions and run engine again at 1500 RPM in neutral and check temperature gauge to verify condition. If overheating still occurs, return to port at low RPM to prevent excessive overheating and engine damage. Consult with your certified engine dealer for service.*

**NOTICE**

*When laying up the boat for winter it is important that the seawater cooling system be flushed with fresh water and inhibited so that deposits do not dry and to prevent the buildup of salt crystals. Please consult your engine owner's/operator's manual for proper engine and cooling system winterization procedures.*

## E - 6 RUNNING ANGLE & TRIM TABS

Hull planing surfaces have the least amount of drag at a three to five degree angle with the water. This is the preferred running angle when boating. The running angle has a significant impact on top speed and handling. Heavy load or certain water conditions may make it difficult to achieve the optimum running angle. See Figure E5.



**Boat Properly Trimmed**



**Boat Too High - Trim Bow "Down"**



**Boat Too Low - Trim Bow "Up"**

**Figure E5: Running Angle**

The running angle can be controlled through the use of the Interceptor electronic trim tabs. See Figure E6.



**Figure E6: Control Panel - Trim Tabs**

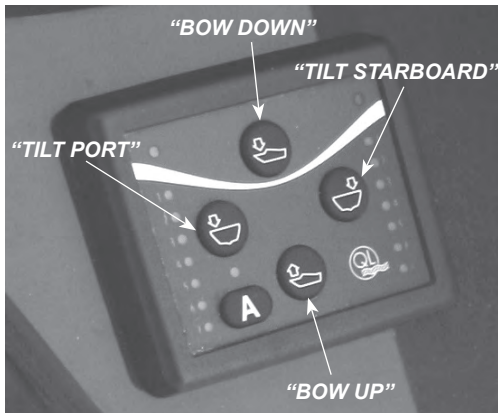
### A. Trim Tabs Control Operation

The control panel has four buttons. By pressing the various buttons the results are as follows. See Figures E7. Refer to manufacturer's operating instructions for additional information.

- 1) The upper button lowers the blades in parallel ("BOW DOWN").



- 2) The lower button retracts the blades in parallel (“BOW UP”).
- 3) The left button lowers the starboard blade and retracts the port blade (“TILT PORT”).
- 4) The right button lowers the port blade and retracts the starboard blade (“TILT STARBOARD”).



**Figure E7: Control Panel Operations**

#### NOTICE

The trim tab blade operation starts when pressing the button and stops when releasing it.

#### NOTICE

When the engine stops (power supply to the panel is lost), the trim tab blades will fully retract after a few seconds.

The LEDs on the panel have variable light intensity in four steps and OFF. By pressing the left and right buttons simultaneously for approximately 1 second, the light intensity of the LEDs takes one step down. As long as the 2 buttons are pressed in, the intensity takes one more step down for each 0.5 second. When the intensity reaches the OFF level, it returns to maximum intensity again and keeps toggling like this as long as the 2 buttons are pressed in. When the buttons are released, the intensity of the LEDs will stay at the current value. If several panels are connected to the system, only the panel where the buttons are pressed will be affected. After power off, the panel LEDs will restart at maximum light intensity when power on.

## B. Control Listing

Wind, loading and many other factors can result in the boat tilting or leaning towards one side while running. This is called listing and can be negated using trim tabs.

After stabilization of speed and direction, press the correct trim tab button to achieve a level side to side running attitude.

## C. Induce Planing & Controlling Trim Angle

Trim tabs can also be used to facilitate faster planing and allow better control of the running angle.

Before accelerating and trying to gain plane, press upper button. This will cause both trim tab blades to lower in parallel and force the bow down when running. This can also be used when running the boat with a heavy load aboard.

Moving the trim tab blades downward will increase the lift and the boat will achieve plane faster, or stay on plane at a lower engine and boat speed.

After gaining plane and establishing cruising speed, pressing the lower button retracts the blades in parallel and will allow the bow to rise. This should be used to adjust the running attitude of the boat to decrease the drag at cruising speed or above, or when running in a following sea.

When running at an engine speed that results in the boat falling off plane or causes the boat to plane inefficiently, lowering the blades slightly (bow down) will improve the running angle and improve operating efficiency.

Optimum efficiency is obtained when operating at a 3 to 5 degree running angle. Utilizing too much “Bow Down” trim tab can reduce operating efficiency and cause substantial steering and handling difficulties. Be extremely careful when running in a following sea. The effect of trim tabs is amplified under such conditions. Steering and handling difficulties can result from improper trim tab usage, especially in a following sea. If unsure of proper trim tab positioning, raise the trim tabs to the full-up position.

**WARNING**

When running at high engine speeds, be sure the trim tabs are in the full up position. Trim tab action should be only enough to compensate for any listing. Trim tab adjustments at high speeds are extremely critical. Be prepared to slow down should handling difficulties arise.

When running in a displacement (very slow speed) mode, better efficiency will be obtained with the trim tabs in the full-up position.

Remember that most boats react very slowly to trim tabs. Often boat owners do not give trim tabs time to work. Press the trim tab switches for only one second at a time and then allow some time for the boat to react. If the boat is still listing after a minute or two, press the trim tab switch again for a one second interval. The labels on the trim tab switches indicate what you want your boat to do, not what you want the tabs to do.

It is a good idea to take your boat out onto open water shortly after you get it and experiment with the trim tabs. After you get your boat onto plane, set the tabs in various positions and note how your boat reacts. This will give you a feel for how the trim tabs work.

**D. Trim Tab Maintenance**

Regularly check for any water intrusion where the interceptor trim tab units are mounted. When needed, paint the external surface of the interceptor unit with anti-fouling paint. **Note:** Do not paint any moving parts, e.g. the blade! Refer to the manufacturers information for additional maintenance information.

**E - 7 ENGINE INSTRUMENTATION**

**A. EVC System Display**

The V475's helm station is equipped with a two Electronic Vessel Control (EVC) system displays. One for each engine. This instrument displays operating information about the engine and allows you to communicate with the engine's electrical system. Close observation of the informational displays could save the engines from damage. See Figures E8, E9 & E10.

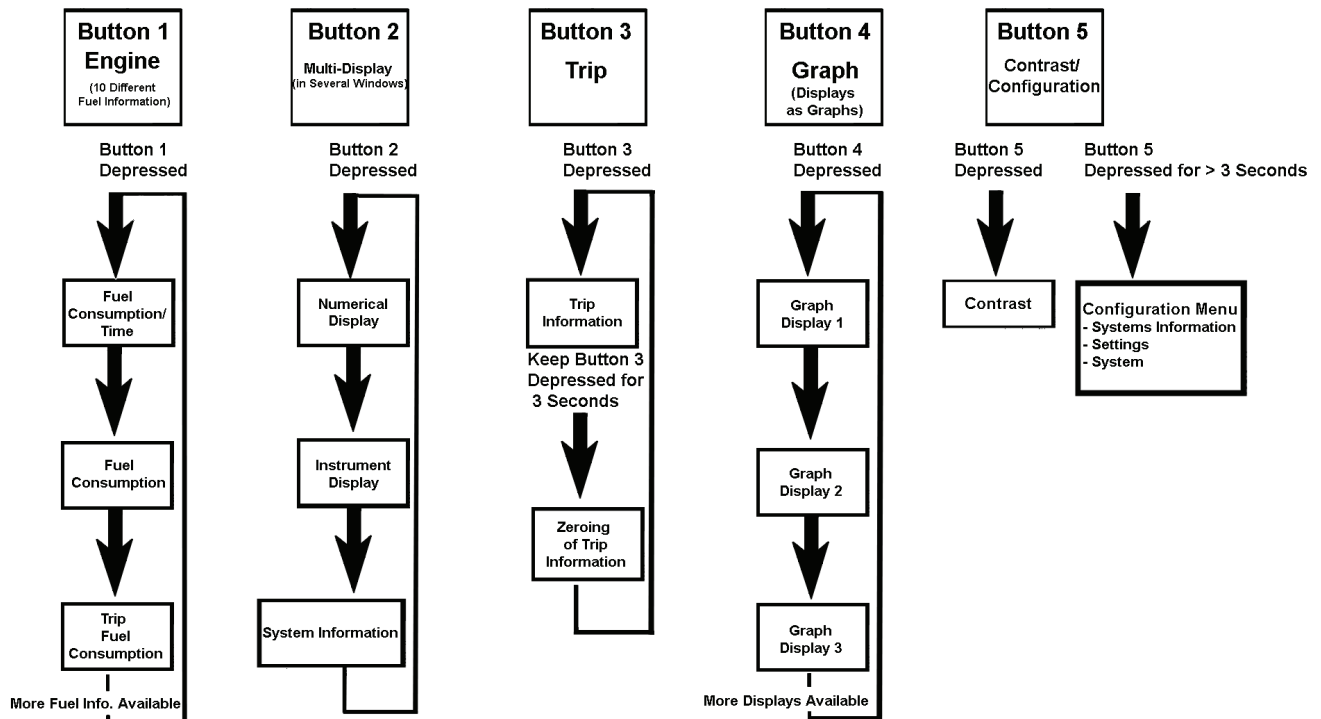
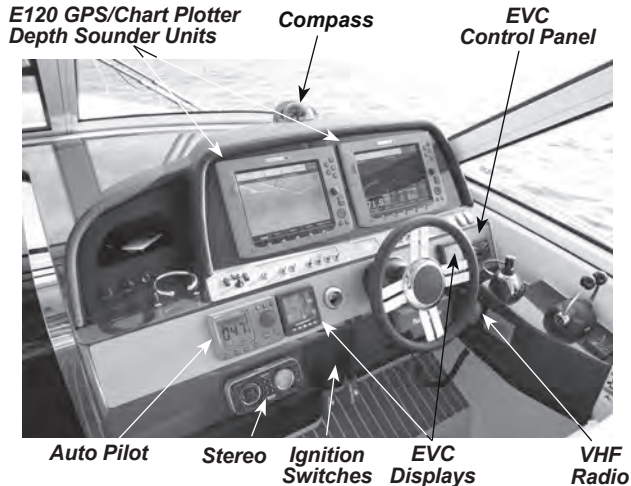


Figure E8: Structure of EVC Display Functions



**Figure E9: V475 Helm Station**

Operation information is shown on an LCD display. The driver can select the display mode function on the display with the aid of the five buttons on the front of the instrument. See Figures E8 & E10.



**Figure E10: EVC System Display**

The four buttons at the furthest left are used to display operating information in different ways. The button at the furthest right is used to adjust the display contrast and to access the so-called configuration menu. See Figure E8 regarding the structure of the EVC display functions.

The various operating information that can be viewed on EVC system display are as follows:

#### NOTICE

See engine operator's manual or EVC system display user manual for corresponding symbols relating to the various operating information displayed.

- Engine Speed - indicates the speed of the engines in revolutions per minute (RPM). This speed is not the boat speed or necessarily the speed of the propeller.

#### NOTICE

Never exceed the maximum recommended operating RPM of your engines. Maintaining maximum, or close to maximum RPM for extended periods can reduce the life of the engines.

- Coolant Temperature (Engine & Cooling System) - monitors the cooling system of the engine and cooling systems. A sudden increase in the temperature could be a signal of a blocked cooling passage or a water pump malfunction.

#### NOTICE

*Operation of an overheated engine can result in engine seizure. If an unusually high temperature reading occurs, shut the engine off immediately.*

- Engine Temperature - monitors the temperature of the engine.
- Fuel Pump Pressure - monitors the amount of pressure in the fuel system created by the fuel pump.
- Oil Pressure - indicates the pressure in the engine lubrication system. A drop in oil pressure is a possible indication of oil pump or leakage problems.

#### NOTICE

*Operation of an engine with abnormally low oil pressure can lead to engine damage and possible seizure. Have the engine serviced immediately upon a reduced oil pressure indication.*

- Speed - displays the boat's speed.

**NOTICE**

Speedometers/speed indicators are not precision instruments. The indications are relative and should never be used for navigational purposes or similar critical situations alone. Use other navigation systems in conjunction with the speedometer.

**NOTICE**

*DO NOT rely on the speed indicator when trying to achieve a “NO WAKE” condition in a harbor or other enclosed waterway. ALWAYS be cognizant of the size of your waves your boat is making and reduce throttle until you are sure that they will not cause any damage. You are responsible for damage caused by the wake of your boat.*

- Fuel Consumption - monitors the amount of fuel being used.
- Turbocharge pressure (Current) - monitors the pressure created by the turbocharger.
- Induction Air Temperature - monitors the air temperature being induced into the engine.
- Exhaust Temperature - monitors the temperature of the exhaust gases being expelled from the engine.
- Voltage - monitors battery condition and thus alternator performance.
- Oil Pressure, Drive - measures and displays the Drive-unit's oil pressure.
- Oil Temperature, Drive - measures and displays the Drive-unit's temperature.
- Fuel Level - displays the amount of fuel that is present in the fuel tank.

**NOTICE**

Due to the mechanical nature of the fuel sender, variations in readings during various speeds of operation may occur. This system is merely a relative indication of the available fuel supply and not a calibrated instrument. Refer to Section I-1F - Fuel Senders for additional information.

**NOTICE**

*Fuel gauges are not precision instruments. The reading is relative, and should never be relied upon as the sole indicator of fuel availability.*

**NOTICE**

*Use only clean, dry fuel of the type and grade recommended by the engine manufacturer. The use of incorrect or contaminated fuel can cause engine malfunction and serious damage. Refer to Section I - Fuel System for additional information.*

- \* Differential pressure, Oil Filter - monitors the pressure at the differential of the oil filter.

Review the engine operator's manual and EVC system display user manual for detailed instructions regarding its use. These manuals are included in your owner's packet.

**B. EVC Control Panel**

The EVC control panel is used in conjunction with the EVC system display. See Figures E10 and E11. The EVC system display shows operating information and menus that can be navigated from the EVC control panel. Navigate through the menus by turning the wheel on the EVC control panel. Press the wheel to confirm a selection. Review the engine operator's manual specific instructions regarding the use of the EVC control panel.



**Figure E11: EVC Control Panel**

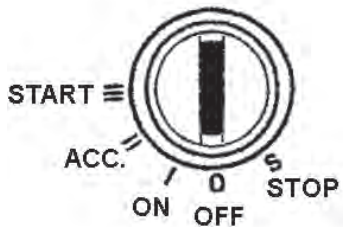


### C. Engine Hour Meter

Engine hour meters can be accessed through the EVC systems display. The hour meter shows a numeric record of elapsed engine operating time. This information is important in determining scheduled maintenance intervals, ships log data, cruise information, etc.

### D. Ignition Switch

The ignition switch has five positions: STOP, OFF, ON, ACCESSORY and START. See Figure E12. Refer to Section A of this manual and the engine operator's manual regarding "step-by-step" instructions on ignition switch operations.



**Figure E12: Ignition Switch Positions**

### E. Alarm System

If a fault occurs, the audible warning will sound and the relevant warning lamp on the alarm panel will start to flash and the display will show an alarm pop-up. Do the following:

1. Reduce engine speed to idling
2. Acknowledged the alarm by pressing the navigation wheel on the control panel once.

When the fault has been acknowledged, the lamp concerned gives constant light and the audible warning will become silent. Please refer to the "In Case of Emergency" chapter of the engine operator's manual where you will find detailed information about recommended action in the "Diagnostic function" section.

The fault will also be stored in the form of a fault code for as long as the malfunction remains. It is possible to read the fault code during a subsequent service.

### F. Navigational Equipment

Four Winns offers a navigational package as an option. See Figures E13 & E14. Please consult the manufacturer's literature included in the owner's packet for operation and maintenance of these navigational systems (if installed).

#### **NOTICE**

*Four Winns does not limit you to this specific navigational package mentioned above. There are many navigational systems on the market today. You may desire to use a different system based on your needs, personal preference, and mounting space available.*

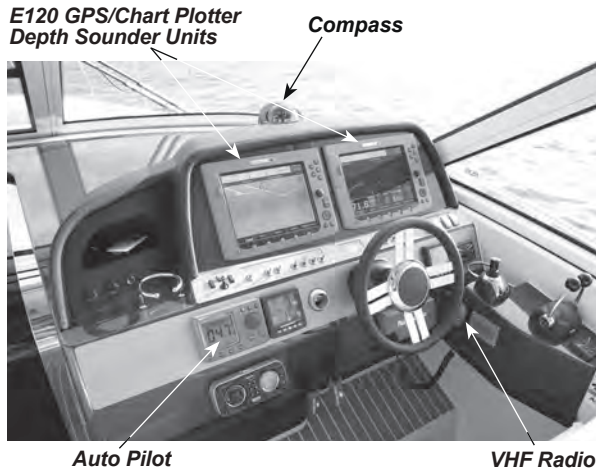
#### **NOTICE**

*Four Winns continually strives to improve its products. Unit specifications, including standard and optional equipment are constantly being modified. Equipment availability is also subject to change. The most current and accurate information available at the time of publication is included in this manual. Some variation in equipment, description, location, and details can result.*

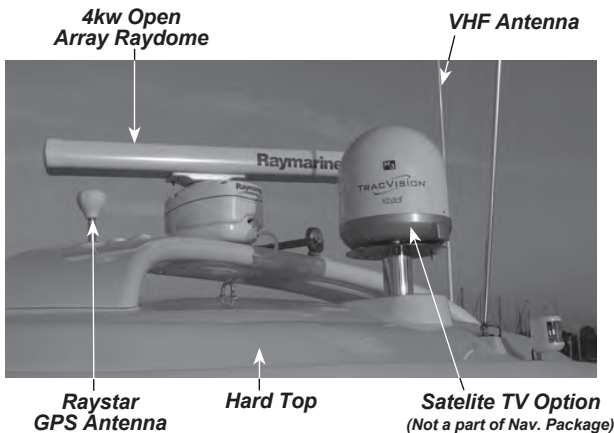
#### **NOTICE**

These devices are only an aid to navigation. Their accuracy can be affected by many factors including equipment failure or defects, environmental conditions, and improper handling or use. It is the user's responsibility to exercise common prudence and navigational judgement. These devices should not be relied upon as a sole means of navigation nor as a substitute for such prudence and judgement.





**Figure E13: Navigation Package - Helm**



**Figure E14: Navigation Package - Hard Top**

### 1. Ship to Shore VHF Radio

A VHF radio is optional equipment offered with the selection of the navigation package option. It provides reliable communication between vessels, and from ship to public or private shore stations. It is programmed for two-way communication on all the International, US and Canadian channels plus reception on separate weather channels, and the international calling and safety channels (16/9). The VHF radio with microphone is mounted on the helm. If equipped, additional information is included in the manufacturer's literature included in the owner's packet.

### 2. GPS/Plotter/Radar/Depth Sounder

A GPS/chart plotter is an electronic system through which a navigator can determine his position regardless of weather. The GPS sensor receives high frequency radio signals generated from satellites to generate coordinate readings on the display. The

GPS navigational units take this information and use it to determine the vessel's exact position and indicates the vessels position on the chart plotter. The chart plotter allows one's course to be plotted electronically. Two factory installed GPS/Plotter systems are offered in the optional navigational package. They are mounted at the helm. If equipped, refer to the manufacturer's literature included in the owner's packet.

#### NOTICE

*You should not rely on these displays as your primary source of navigation. Rather, you should use the chart plotter as a backup to official government charts and traditional methods of navigation.*

Radar along with the GPS/Plotter is included in the navigation package option. The radar detects objects/targets and displays them for the operator to see. If so equipped refer to the manufacturer's literature included in the owner's packet for operation instructions.

A depth sounder feature is also included with the navigation package option. The depth sounder use the basic principle of sonar to indicate the water's depth. Please consult the manufacturer's literature included in the owner's packet for operation of this feature.

#### WARNING

*Do not rely on depth sounder to avoid submerged objects. Depth sounders provide a relative indication of water depth only.*

#### NOTICE

*DO NOT depend solely upon the depth sounder for water depth. It is important to have navigational charts of the waters in which you are operating.*

### 3. Compass

A compass is standard on the V475 models. See Figure E15. The compass can provide directional information when operating offshore, in unfamiliar waters, or in adverse weather conditions.



**Figure E15: Compass**

After all personal equipment is installed, including all electronics (VHF radio, GPS, chart plotter, etc.), the compass must be properly calibrated. DO NOT rely on the compass readings until initial adjustment (compensation) has been performed. The boat has a factory installed compass, the manufacturer's instructions are provided in the owner's packet. Most areas have local companies that specialize in compass adjustment. If unsure of the proper compensation techniques, consider having the adjustment done professionally to insure accuracy and confidence in the compass.

#### **NOTICE**

*During use, keep all extraneous metal objects away from the compass. The close proximity of metal objects (e.g., beverage cans) can cause compass deviation.*

### **G. Instrument Maintenance**

The EVC system and the optional electronics (if installed) should be maintained in accordance with the manufacturer's operating instructions. Should repairs need to be made, do not attempt to repair these units yourself. **Repairs must be performed by an authorized service technician.**

The ignition switches and all electronics, controls, etc. should be protected from the weather when not in use. Four Winns provides a canvas helm cover for just such a purpose. Excessive exposure can lead to display and ignition switch difficulties. If these units and/or helm area itself come in contact with salt spray, simply wipe the affected surfaces with a soft, clean cloth dampened in fresh water.



**F - 1 GENERAL**

Control systems permit operation of the engine's throttle and shift mechanisms. The V475 IPS models are equipped with a dual engine electronic binnacle control. See Figures F1 and F2.



**Figure F1: Helm Station**

**F - 2 CONTROL OPERATION**
**A. General**

The left lever controls the port engine and the right lever controls the starboard engine. Both the shift function and the engine speed are controlled by the lever control. Moving the lever forward will shift the drive into forward. Moving it aft will shift the drive into reverse. Moving the lever further will increase engine speed. See Figures F2 & F3.



**Figure F2: Electronic Control**

**NOTICE**

*The control information included in this section is general only. For specific operation of the controls on your boat, refer to the control manufacturer's literature and engine manufacturer's literature included in your owner's packet. Ensure you completely understand the operation of the controls before operating your boat. Also consult your dealer should any questions arise regarding the operation of the control unit.*

**NOTICE**

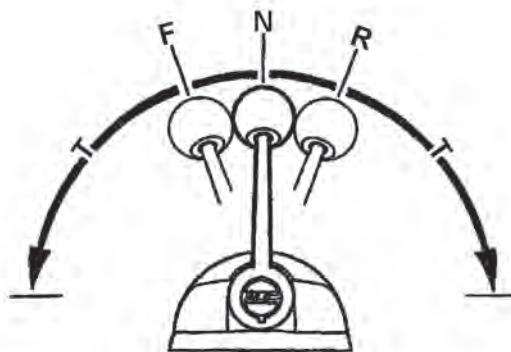
*Allow the engine to idle for the first ten seconds. Monitor all instruments and displays to ensure normal readings are shown. Check that no alarms are displayed and that no warning lights are flashing. Then warm the engine at low speed and low load until engine reaches normal temperature before full power is used.*

**NOTICE**

*If your boat is equipped with a non-OEM remote control system, ask your dealer how to properly operate it.*


**B. Shifting and Control Speed**

1. Move shift/throttle lever(s) to the neutral idle position. Placing the shift/throttle levers in the neutral detent position will engage neutral start switch and allow engine to start. The engine can not be started if the control lever is in any other position but NEUTRAL. See Figure F3.



**Figure F3: Electronic Control Lever Positions**

- N** - Neutral position. Drive-unit is disengaged and the engine runs at idle speed.
- F** - Reversing drive-unit engaged for forward movement (ahead).
- R** - Reversing drive-unit engaged for rearward movement (astern).
- T** - Adjustment of engine speed.

 **CAUTION**

*DO NOT shift into FORWARD or REVERSE unless engine is running. Damage to the shift system could result from trying to shift without the engine running. Carefully check function of all control and engine systems before leaving the dock.*

2. To go FORWARD - move the shift/throttle lever(s) forward. Once forward gear engagement is complete, push shift/throttle lever(s) forward until desired speed is achieved.
3. To go in REVERSE - move the shift/throttle lever(s) rearward. Once rearward gear engagement is complete, push shift/throttle lever(s) rearward until desired speed is achieved.

 **WARNING**

*DO NOT shift from forward to reverse when the boat is planing.*

 **CAUTION**

*DO NOT shift if engine speed is above 1500 RPM. Shifting at higher engine speeds can place unnecessary stress on the drive-unit or cause engine to stop.*

4. To go from FORWARD to REVERSE, or REVERSE to FORWARD; always pause at NEUTRAL and allow engine speed to return to idle. **Note:** A beep will sound to indicate that the control lever is in NEUTRAL.

 **CAUTION**

*On a boat with twin engines it is important that both engines be running during reverse procedures, to avoid the risk of water entry (via the exhaust pipe) into a stationary engine.*

5. After shifting is completed, slowly push throttle lever(s) forward/rearward until desired speed is achieved.

 **WARNING**

*Any time the boat is operated, be aware of changes in shift system operation. A sudden increase in shift effort of the shifter levers, or other abnormal operation, indicates a possible problem in the shift system. If this occurs, the following precautions must be taken:*

- *With engine running and boat securely tied to the dock, shift drive into forward and reverse to ensure there is gear engagement.*
- *When docking the boat, all docking maneuvers must be performed at slow speed. Pay special attention to other boaters. Passengers should be informed of potential problems and precautions taken.*

If you suspect there is a problem, see your Volvo Penta® dealer as soon as possible for proper diagnosis and required service or adjustment. Continued operation could result in damage to the shift mechanism and loss of control.

### C. Engine Speed Synchronization

During the general operation of a twin engine boat, it is advantageous for both engines to be operated at the same engine speed (rpm). This reduces noise and vibration, and can increase propulsion system efficiency. Setting the throttles so the engines are running at the same rpm (synchronized) can be done by using the synchronization function on the electronic binnacle control. Follow the engine manufacturer's operating instructions regarding synchronization of the engines. These instructions are included in your owner's packet.

Attempting to synchronize the engines by manually controlling the throttle lever placement will generally not be effective. When the engines are in proper synchronization, the throttle levers may not necessarily be in the same position.



### F - 3 NEUTRAL SAFETY SWITCH

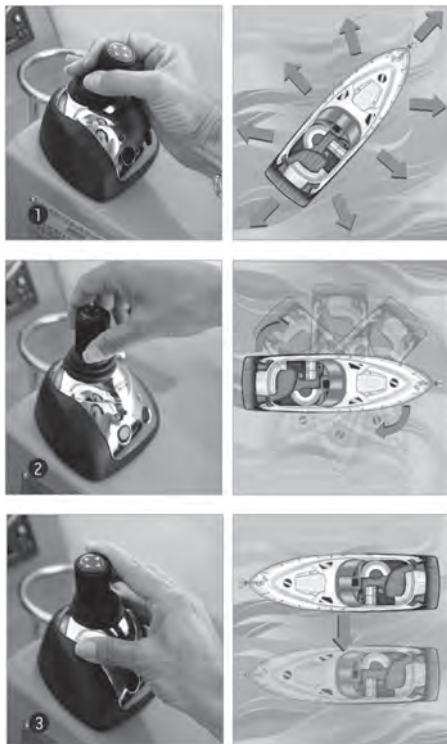
Every control system has a neutral safety switch incorporated into it. This device prohibits the engine from being started while the shift lever is in any position other than the neutral position. If the engine will not start, slight movement of the shift lever may be necessary to locate the neutral position and disengage the safety cutout switch. Should control adjustments be necessary they must be done by a authorized service technician.

### F - 4 JOYSTICK CONTROL

The Volvo Penta IPS Joystick is designed as a docking aid. It can be used for all you slow-speed maneuvering. The joystick allows the operator to maneuver and moor the boat in a simpler and safer manner. See Figure F4. Refer to the engine operator's manual for specific instructions on the proper use of the Joystick.

 **WARNING**

*Learn to use the Joystick control and its functions in a safe and correct manner before using at the dock.*



**Figure F4: Joystick Control**

### F - 5 CONTROL SYSTEM MAINTENANCE

The electronic binnacle control and Joystick control are designed to provide years of trouble-free operation with virtually no maintenance required. Do not attempt to repair these control units yourself. **Repairs must be performed by an authorized control service technician.**

If the control units comes in contact with salt spray, simply wipe the affected surfaces with a cloth dampened in fresh water.





**G - 1 GENERAL**

The steering system is operated through the Electronic Vessel Control (EVC) system provides a smooth and exact steering. It offers steering capabilities which are not possible with traditional steering systems. Consult engine operator's manual for specific information.

The helm steering unit sends an electrical signal via the EVC system to the servo unit steering (SUS) on the drive-unit.

The electronic steering is progressive and the turn rate automatically adjusted to suit the actual boat speed for optimized comfort and boat handling. The wheel spins easier at low speeds, further reducing driver effort.

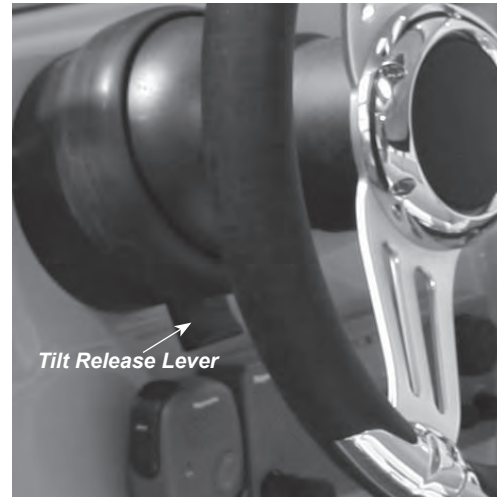
For reliability the steering system is built with redundancy on several levels.

 **WARNING**

*Full lock when driving at high speed will make the boat turn strongly, which entails a great risk of personal injury, and/or people aboard may fall over or be thrown overboard. Warn everybody aboard before doing any emergency maneuvers.*

**A. Tilt Steering**

The steering wheel can be tilted up or down so as to enhance the driver's comfort and enjoyment. To tilt the steering wheel, depress the release lever with your thumb. See Figure G1. Be sure to hold the top of the wheel to assist in positioning. Refer to the steering manufacturer's literature for additional information.



**Figure G1: Tilt Steering**

 **WARNING**

*The tilt mechanism should not be adjusted when the boat is moving. Sudden boat movement may cause loss of balance resulting in loss of control and/or injury.*

 **WARNING**

*The tilt mechanism is spring loaded. Due to the variation in steering wheel offerings, the wheel may spring up rapidly when depressing the release lever. **ALWAYS KEEP ONE HAND ON THE WHEEL DURING TILT ADJUSTMENT OR INJURY MAY OCCUR.***

**G - 2 STEERING LOAD**

On boats with conventional drives, a load is placed on the steering system by the propeller torque, and/or water flowing past the outdrives. With the IPS the propulsion forces and vibrations are absorbed by the combined rubber suspension and sealing. The propellers operate in undisturbed water with no cavitation. Also an increased number of propeller blades distribute the forces thereby reducing the effect of the pulses created by the propellers on the hull. All of this combined with the Electronic Vessel Control (EVC) system provides a smooth and exact steering with minimal to negligible steering load.

### **G - 3 PROPELLER TORQUE**

A boat with conventional drives, the propeller rotation of a single engine operation will exert a directional force on the steering system. This can cause the steering to be harder in one direction than the other, and is called propeller torque. Propeller torque can also cause the boat to wander (not follow a straight line) when operated at low speeds. Wind, water and currents can cause equivalent effects.

On the V475 with IPS, there are two counter-rotating propellers on each propulsion unit which means there are no lateral forces to consider and that tracking is completely straight. Propeller torque is negated.

### **G - 4 STEERING SYSTEM MAINTENANCE**

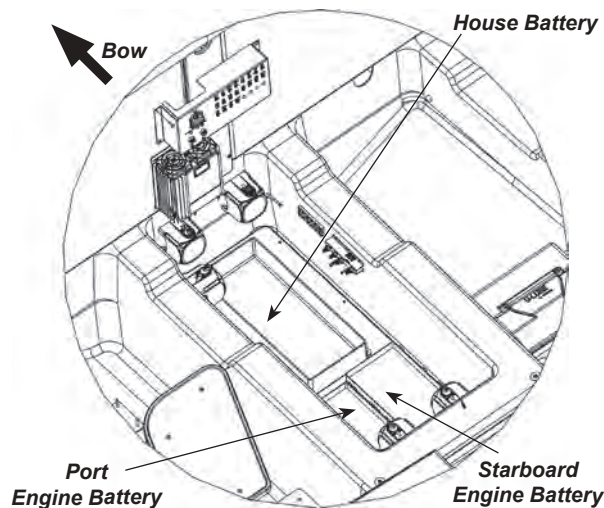
The V475 has an advanced steering system. Do not change connectors, wiring or splice of the components.

Periodic inspections (every 200 hours/at least once a year) of the EVC system must be conducted. Service must be done by approved Volvo Penta service centers which have certified personnel with qualified professional training. Contact your Four Winns dealer for assistance.

**H - 1 GENERAL**

All electrical equipment on the Four Winns V475 models operates on 12 volts DC or 240 volts on 60 Hertz AC electrical power. On domestic models the 240 volts AC supplied is then split to two (2) - 120 volt AC circuits. The exception being the air conditioner which remains at 240VAC. 230 volts on 50 Hertz models AC electrical power is used for most export model applications.

The V475 is equipped with a triple battery system along with dockside power (including battery charger) as standard features. The batteries are located in the engine compartment under the battery compartment lids. See Figure H1.



**Figure H1: Battery Locations**



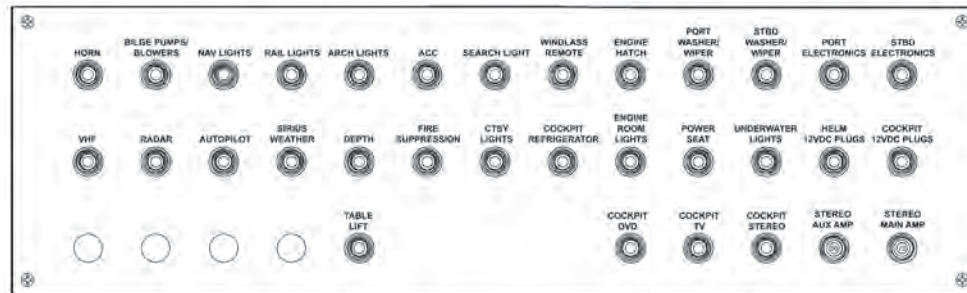
**Fire or Explosion Hazard!**  
 Electrical system parts are designed by and manufactured to comply with the US Coast Guard requirements to minimize risks of fire or explosion. **Never substitute automotive parts for marine parts.** Automotive parts do not provide the necessary ignition spark protection.



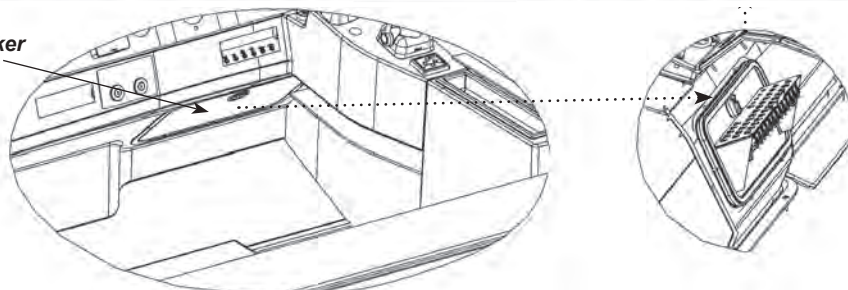
**DO NOT tamper with any electrical connection, panel or harness, or attempt installation of any electrical equipment unless thoroughly familiar with the systems and experienced in making such installations.**

**H - 2 CIRCUIT BREAKER PANELS**

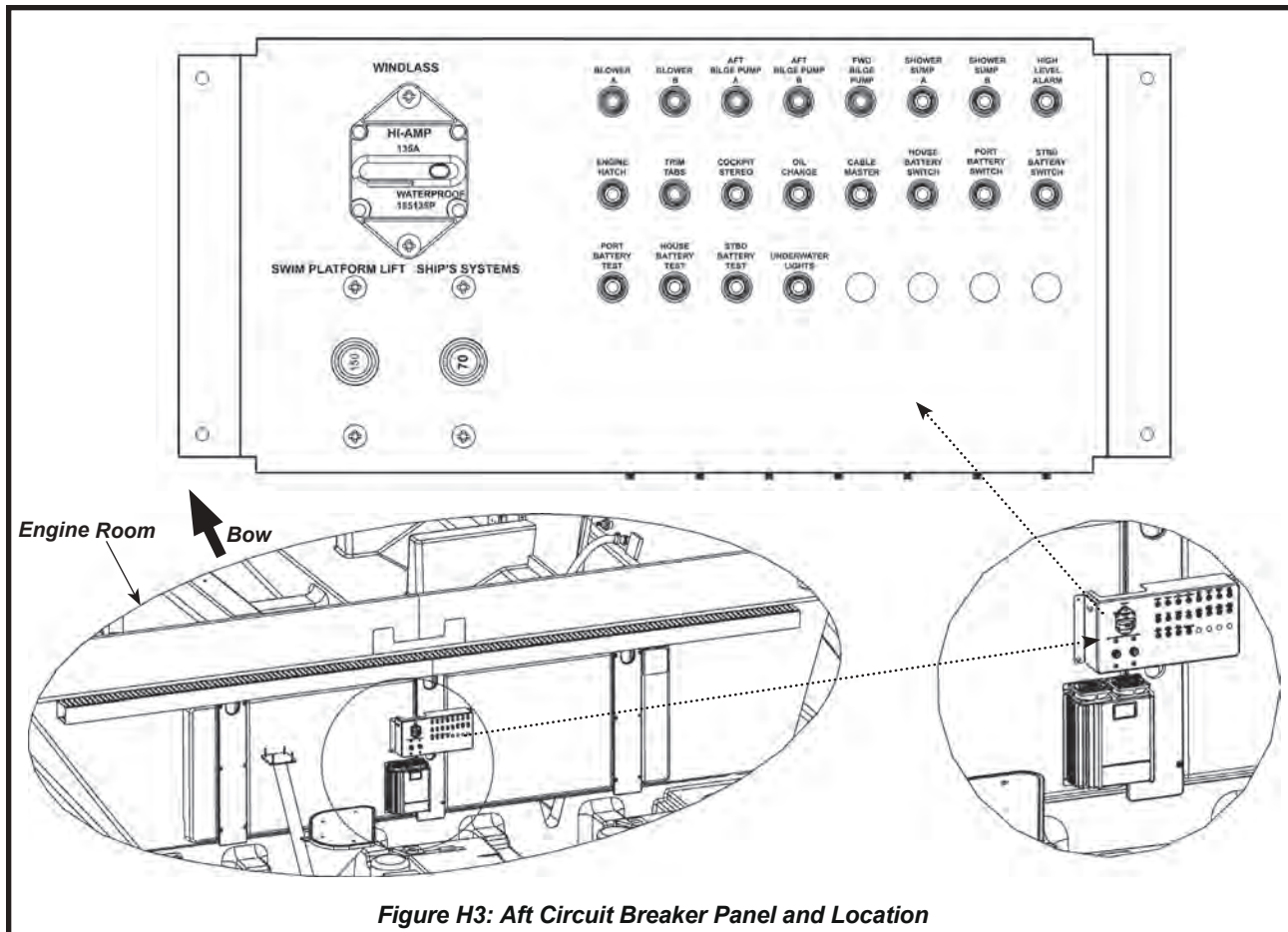
The helm circuit breaker panel, aft circuit breaker panel and the cabin electrical panels are placed in specific areas of the boat. For specific locations of these circuit breaker panels see Figures H2-H6.



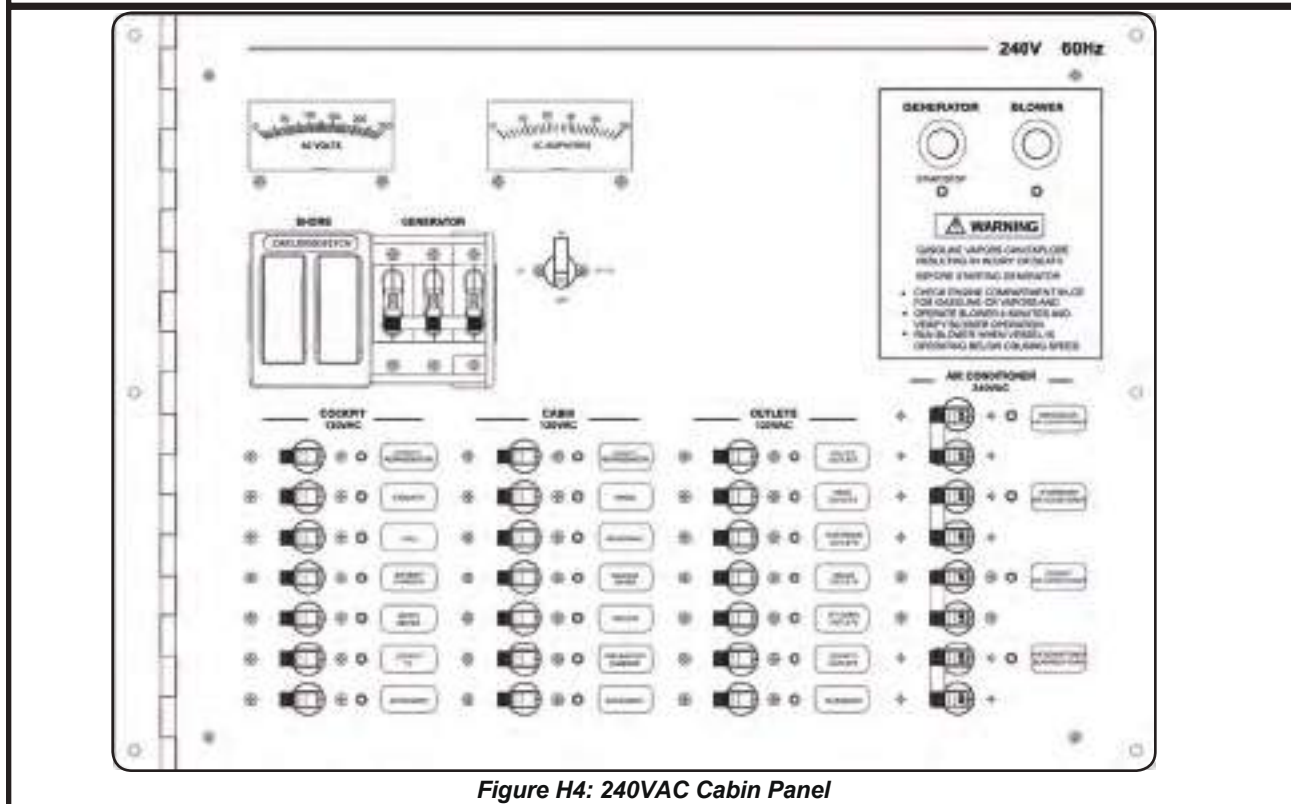
Helm Circuit Breaker Panel Door



**Figure H2: Helm Circuit Breaker Panel and Location**

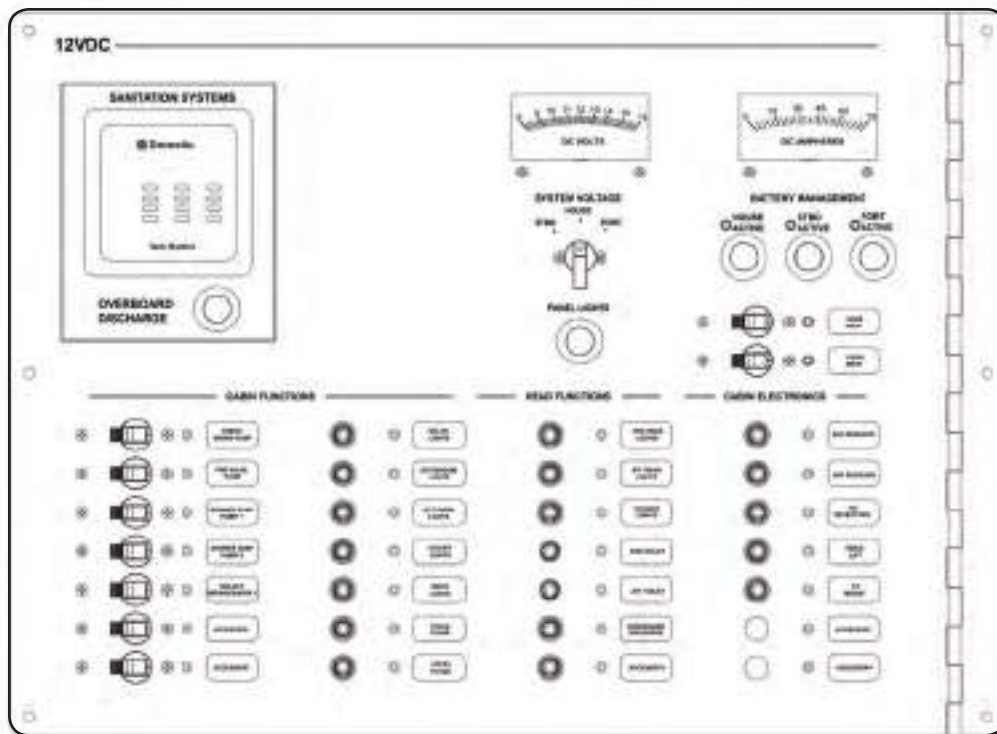


**Figure H3: Aft Circuit Breaker Panel and Location**

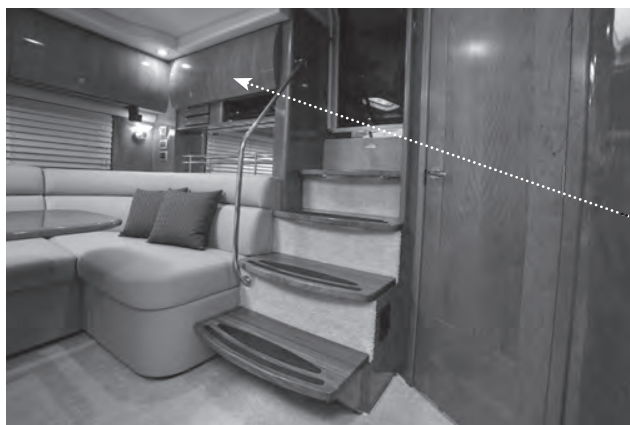


**Figure H4: 240VAC Cabin Panel**



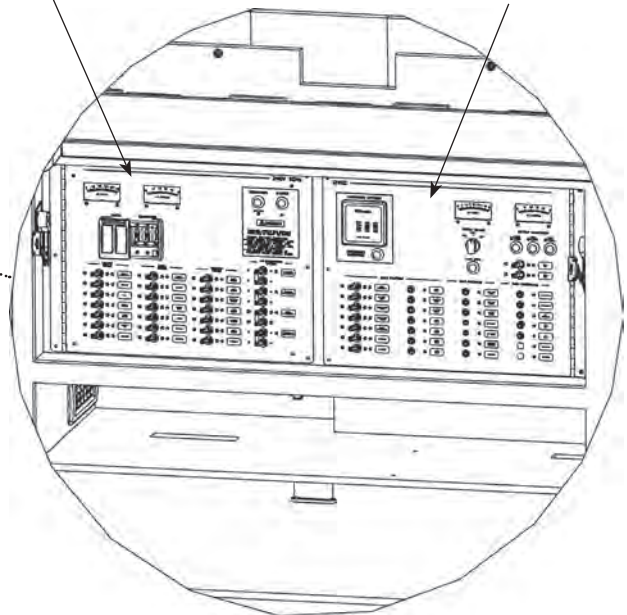


**Figure H5: 12VDC Cabin Panel**



AC Cabin Panel

DC Cabin Panel



**Figure H6: AC & DC Cabin Panel Locations**



The circuit breakers are labeled on the panels which identify the component circuitry protected (Figures H2-H5). These circuit breakers protect the designated circuitry from damage caused by an overload or short circuit.

#### NOTICE

Listed on the circuit breaker panels and cabin electrical panels are various labels for the circuit breakers protecting different component circuitry. A particular label does not necessarily mean your boat is equipped with this component if either the component is optional or not available to that particular model. Please see your Four Winns dealer for details.

If a circuit breaker does trip, determine the cause of the fault. Take the necessary steps to correct the cause. Once the correction has been made reset the circuit breaker.

#### WARNING

Do not keep resetting a circuit breaker without investigating the cause of the fault. Doing so could lead to damage to component circuitry or possible fire. Please see your authorized Four Winns dealer should problem persist.

Note: The engines and drive units are fitted with automatic circuit breakers. The circuit breakers cut the power should the system be overloaded. Please see engine operator's manual for specific information.

### H - 3 BATTERY CHARGER

The battery charger is standard on the V475 models and is located in engine compartment. See Figure H7.

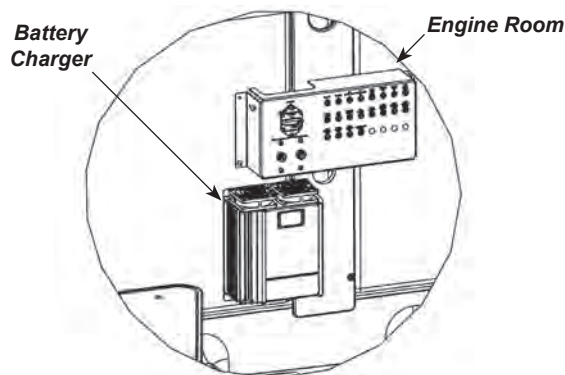


Figure H7: Battery Charger Location

The batteries will be charged by the battery charger when the boat is connected to dockside power and the SHORE circuit breakers and BATTERY CHARGER circuit breaker are "ON". These breakers are located on the AC cabin panel. See Figure H4. If a generator is available and operating, it too will allow the batteries to be charged by the battery charger when the BATTERY CHARGER circuit breaker is placed in the "ON" position. **Note:** On V475 models with IPS the FWD BATTERY CHARGER (if applicable) is **not** utilized.

Additional information on the battery charger can be found in Section H-8B - 120 Volt AC Equipment in this manual and refer to the manufacturer's literature included with the owner's packet.

### H - 4 SYSTEM VOLTAGE

On the DC cabin panel a voltmeter is installed. This voltmeter allows one to monitor the condition of the port engine, starboard engine or house battery. Place the selector switch to the desired battery to be checked and the voltage will be indicated on the voltmeter. See Figures H5 and H8.

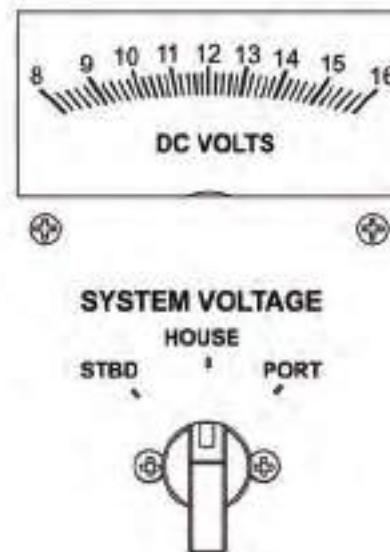


Figure H8: DC Cabin Panel - Voltmeter

It should be noted that the engine battery voltage may also be checked using the respective EVC display. Additional information on voltage may be found in the engine owner's manual.

## H - 5 12 VOLT ELECTRICAL EQUIPMENT

### A. Helm Equipment

Helm equipment circuitry is protected by circuit breakers in the helm and/or aft circuit breaker panels, or in the cabin's DC panel. The power is supplied to the helm by the house battery when the battery is placed in the "active" mode. Depress the push-button labeled "HOUSE ACTIVE" switch on the DC cabin panel. A green LED should light up indicating the house battery is "ON" and supplying power to the ship's 12 volt systems. See Figures H5 & H9.

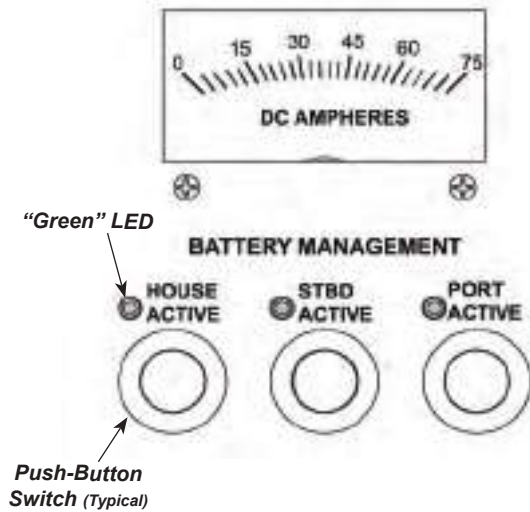


Figure H9: Battery Activation Switches

The HELM MAIN circuit breaker on the DC cabin panel, when placed in the "ON" position (indicated by the lit "red" LED) supplies power to the helm. See Figures H5 & H10.

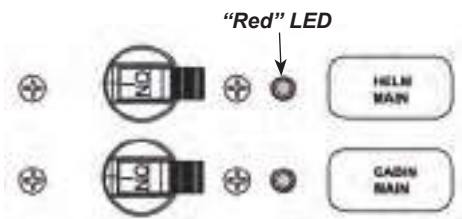


Figure H10: Helm & Cabin Main Circuit Breakers - ON

Helm switches are used to activate/deactivate various equipment. See Figure H11. To assist you, we have listed the descriptions of individual switches, receptacles and their uses:

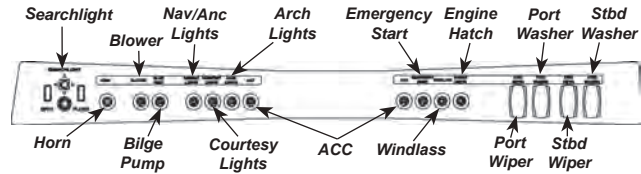


Figure H11: Helm Switch Panel



**CAUTION**  
To prevent electrical problems, use only replacement fuses or breakers that are of equal rating to the originals.

12 Volt DC Receptacle - Permits the use of additional 12 volt equipment such as a cell phone. Using the appropriate adaptor, the equipment draws power from the boat's house battery. See Figure F12.

iPod/MP3 Player Port - Allows you to play music from your iPod or MP3 player over your boat's sound system. See Figure F12.



Figure H12: 12 Volt Receptacles & iPod/MP3 Player Port

Searchlight Remote Control - Allows the searchlight to be operated from the helm. Activate the switch to turn the searchlight "ON". Using the arrow button above the "ON" switch allows the searchlight to be positioned in the desired direction. The searchlight can be either a spot or flood light by pressing the respective switch. See Figure H13. Consult the manufacturer's operating manual for additional information on the use and care of the searchlight.



**Figure H13: Searchlight Switches**

**Horn** - To sound the horn, press the HORN switch.

**Blower** - The BLOWER switch is used to activate the bilge blower. Pressing the switch to the "ON" position, activates the electric bilge blowers, changing the air in the engine compartment that may contain fuel vapors.



*Fuel vapors can explode resulting in injury or death. Before starting the engine, check engine compartment bilge for fuel or vapors. Operate blower for four minutes, and verify blower operation. ALWAYS run the blower when the vessel is operating below cruising speed.*

**Aft Bilge Pump** - The BILGE PUMP switch is used to manually activate the dual bilge pumps in the engine compartment. The bilge pumps are used to remove water from the bilge (bottom of the hull) area of the boat by pumping this water overboard. The aft bilge pumps are equipped with an automatic bilge switches and will operate whenever bilge water rises to a level that will cause the floats to move upward.

This automatic bilge pumps are active even if the battery activation switches on the DC cabin panel are in the "OFF" position. The automatic bilge pump circuitry is connected directly to the batteries. Circuit breakers are located at the helm circuit breaker panel and the aft circuit breaker panel.

When leaving your boat unattended for an extended period, check the charge on the battery(s) periodically. Also check the water level in the bilge and make sure the float switches are functional. If the automatic bilge pumps must be disabled, disconnect the wiring plug near the respective bilge pump.

**Navigation & Anchor Lights** - Moving the NAV/ANC LIGHTS switch to the NAV position (up position) activates the bow lights, the front portion of the mast light and the instrument lights on the dash. Move the switch to the ANC position (down position) to activate the all-around portion of the mast light. The center switch position is "OFF".

**Courtesy Lights** - The COURTESY LIGHTS switch is used to activate the courtesy (cockpit) lights. Additional courtesy light switches are located on the companionway light switch panel and on the transom switch panel. The switches may either be labeled COCKPIT LIGHTS or COURTESY LIGHTS. A key fob remote can also be used to activate the courtesy lights.

**Arch Lights** - The ARCH LIGHTS switch is used to activate the overhead lights on the hardtop. Another switch located on the transom switch labeled OVERHEAD LIGHTS will also activate these same lights.

**Accessories** - Additional 12 volt equipment may be added to the boat by the using the ACC switch on the port switch panel. Certain accessories may be wired directly to the helm circuit breaker. For additional information on adding accessories, refer to Section H-5B.

**Underwater Lighting Option** - The starboard ACC switch on the helm is used to operate this option should it be installed. To activate the underwater lighting place the starboard ACC switch to the ON position.

**Emergency Start** - If one of the designated engine batteries fails to start its respective engine, turn EMERGENCY START switch ON and attempt to start the engine. Current is drawn from the other batteries to start the engine. **Note:** The momentary switch combines the batteries for ten (10) minutes. Once back at port, be sure to have the failed engine battery checked out for possible service or replacement.

**Windlass** - The WINDLASS switch activates the windlass. Circuit breakers are located on the helm and aft circuit breaker panels. Refer to the Section M-12 in this manual and the manufacturer's literature for additional information.

**Engine Hatch** - The ENGINE HATCH switch is used to raise and lower the engine hatch by activating a linear screw jack. Pressing the upper portion of the switch allows the engine hatch to be raised. Pressing

the lower portion of switch lowers the engine hatch. When the engine hatch is raised, the engine room lights are automatically turned on. When the engine hatch is closed the lights go off. The same is true should you access the engine room via the engine inspection hatch.

**Port Wiper and Stbd Wipers** - The PORT WIPER or STBD WIPER switch activates the port or starboard windshield wiper respectively. The wiper(s) will self park when switched OFF.

**Port Washer and Stbd Washer** - The PORT WASHER or STBD WASHER switch activates the port or starboard windshield washer respectively.

## B. Installation of Additional 12 Volt Equipment

Accessories may be added to the boat by wiring directly to the cabin panel. Non-factory installed 12 volt accessory equipment can be connected to the port ACC switch on the dash.

### CAUTION

*Be sure to provide proper fuse or circuit breaker protection for all 12 volt equipment that is installed. DO NOT overload the accessory circuitry by installing too much additional 12 volt equipment.*

### WARNING

*DO NOT attempt installation of additional 12 volt equipment unless you are familiar with the proper electrical procedures involved. Failure to properly install equipment could lead to equipment damage and/or possible fire.*

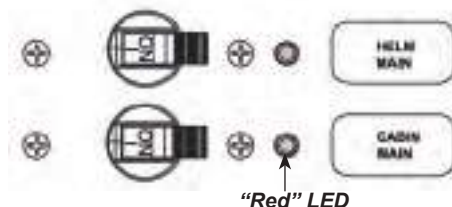
## C. Interior/Exterior Equipment

**Step Lights** - The STEP LTS switch (located on the transom switch) is used to activate the step lights at the transom and for the deck lighting in the rail.

**Transom Speakers** - If installed this switch is part of the transom switch assembly. The switch permits one to conveniently turn the transom speakers "ON" or "OFF" while at the transom.

**Engine Room Lights** - These lights are activated automatically when either the engine hatch or the engine inspection hatch are raised.

Below is a listing followed by a brief description of the V475's 12 volt cabin equipment. The equipment's circuitry is protected by circuit breakers on the 12 volt DC systems cabin panel. The CABIN MAIN circuit breaker on the DC cabin panel, when placed in the ON position (indicated by the lit "red" LED) supplies power to the cabin's 12 volt equipment. See Figure H14. **Note:** The specific circuit breaker must also be activated (placed in the ON position) in order for the desired equipment to work. Additionally, certain 12 volt equipment may have an additional circuit breaker located on another circuit breaker panel. See Figures H2-H3.



**Figure H14: Helm & Cabin Main Circuit Breakers - ON**

Refer to Figure H5 for specific circuit breakers and their locations on the panel. Note: The PANEL LIGHTS push-button switch activates/deactivates the lights on **both** the 12VDC cabin panel and the 240VAC cabin panel.

**Fresh Water Pump** - A pressure water pump delivers water to the faucets, shower, and transom washdown. The pressure water pump will operate automatically as long as the FRESH WATER PUMP circuit breaker switch is ON. Turn the FRESH WATER PUMP circuit breaker switch OFF when the water tank becomes empty or when water will not be required for an extended period or when connected to shore water while at dockside. Tank monitoring systems are available to check water levels. Refer to Section J-1 and J-2 in this manual for additional information.

**Forward Bilge Pump** - The forward bilge pump can be activated manually by the FWD BILGE PUMP breaker switch placed in the "ON" position. Any water from the stringers or from other sources within the cabin will drain into the forward bilge compartment. The pump is equipped with an automatic float switch and will operate whenever bilge water rises to a level that will cause the float to move upward. The water will be pumped overboard.

**Shower Sump Pump 1 & 2** - These shower sump pumps are used to discharge water from their respective shower and sink sumps overboard or into an optional gray water tank (if installed). These sump



pumps have a float switch which will activate the pump when the water level rises in the sump. The respective pump is protected by the SHOWER SUMP PUMP 1 or SHOWER SUMP PUMP 2 circuit breaker.

**Galley Refrigerator/Freezer** - This refrigerator/freezer is a dual voltage unit and therefore has a circuit breaker provided on both the 240VAC cabin panel and on the 12VDC cabin panel to provide protection no matter which power source is being used. The refrigerator/freezer has a separate "ON/OFF" switch also. Refer to Section L-1D in this manual and to the manufacturer's literature for additional information.

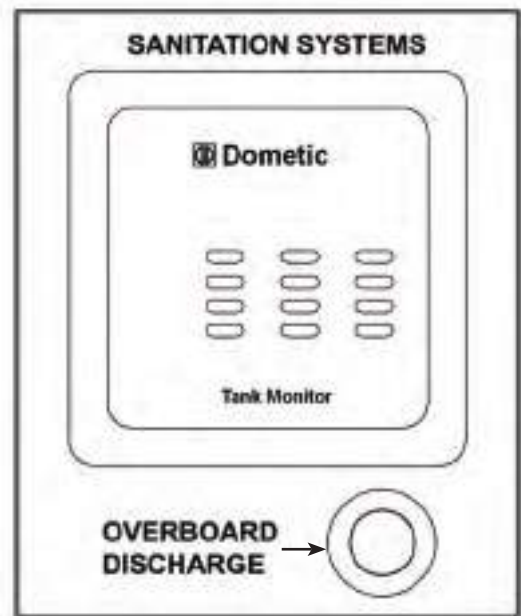
**Accessories** - Additional 12 volt equipment may be added to the boat by wiring directly to the cabin panel using the existing ACCESSORY circuit breakers provided. See Section H5-B -- Installation of Additional 12 Volt Equipment.

**Salon Lights/Stateroom Lights/Aft Cabin Lights/Galley Lights/Night Lights/Fwd Head Lights/Aft Head Lights/Shower Lights** - The light's circuitry are protected by their respective circuit breaker at the panel. With the circuit breaker ON, these various lights may be activated using the corresponding ON/OFF switch. A variety of switch panels assemblies are located throughout the boat. The switches on these panel assemblies are labeled to indicate what switch activates what on that particular light panel assembly. Additional, duplicate ON/OFF light switches may be located in various areas of the cabin i.e. forward berthing area for convenience.

**12 Volt Receptacles** - These receptacles can be utilized when the respective 12VDC PLUGS circuit breaker is in the ON position.

**Forward Toilet and Aft Toilet** - These toilets utilize an electronic switch for flushing and therefore power must be supplied and circuitry protected through their respective circuit breaker labeled either FWD TOILET or AFT TOILET.

**Overboard Discharge (Optional)** - If installed waste from the waste holding tank may be pumped overboard when the OVERBOARD DISCHARGE circuit breaker is ON and the OVERBOARD DISCHARGE SWITCH is depressed. See Figure H15.

**12VDC**

**Figure H15: Overboard Discharge Switch**

**Note:** The seacock for overboard discharge must first be opened before depressing switch. See Section J - Water and Waste Systems of this manual for further details and regulations regarding the discharging of waste overboard.

**Satellite Receivers** - The satellite receiver's circuitry is protected through its respective circuit breaker. In order for the satellite receiver to function its circuit breaker must be ON.

**CO Monitor (Detector)** - The CO monitors' wiring is protected by the circuit breaker in the cabin panel labeled CO DETECTORS.

**Table Lift** - The table lift in the salon is operated through an electrical control and therefore has a circuit breaker labeled TABLE LIFT. The switch that controls the lift is located in the galley, near the TV, and is called the Forward Galley Salon switch panel.

**TV Mount** - The TV mount in the galley is operated through an electrical control and therefore has a circuit breaker labeled TV MOUNT. The switch that controls the TV mount is located on the same switch panel as the table mount.

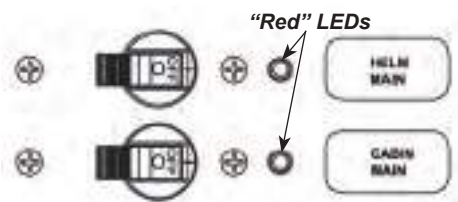


## H - 6 12 VOLT ELECTRICAL SYSTEM SHUTDOWN PROCEDURES

When leaving your boat unattended for an extended period of time it is advisable to shutdown the electrical system to reduce battery drainage and/or possible electrical draw.

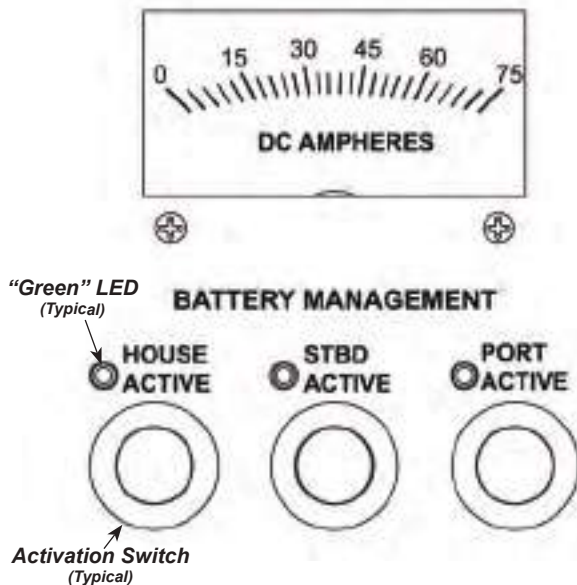
### To shutdown:

1. On the 12VDC cabin panel, turn the HELM MAIN and CABIN MAIN circuit breaker switches to the OFF position ("red" LED's are unlit). See Figure H16.



**Figure H16: Helm & Cabin Main Circuit Breakers - OFF**

2. Depress and release the battery activation switches to the OFF position. The "green" LEDs are no longer lit indicating the batteries are not active. See Figure H17.



**Figure H17: Battery Activation Switches**

## H - 7 240/120 (230V 50Hz) VOLT ELECTRICAL SYSTEM

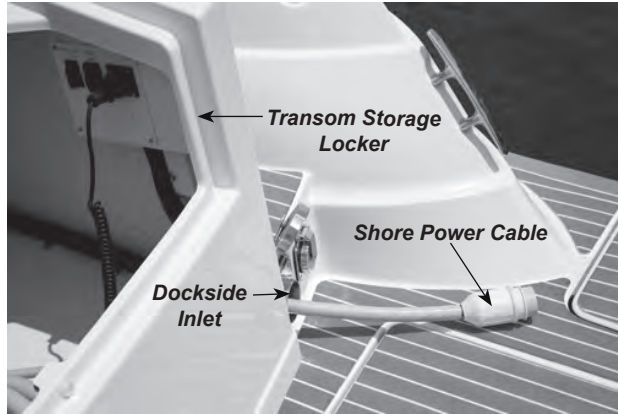
The boat is equipped with 50 amp, 240/120 volt, 60 Hertz AC electrical wiring. **Note:** On domestic models the 240 volts AC supplied is first split to two (2) - 120 volt AC circuits. The exception being the air conditioner which remains at 240VAC. When the boat is connected to a shore power outlet and the respective circuit breaker(s) is ON, the AC system supplies 240/120 volt (230 volt 50Hz - export) electrical power to the following items: cockpit refrigerator, icemaker, grill, battery charger, water heater, cockpit TV, galley refrigerator, washer/dryer, range, microwave, vacuum, and/or various outlets. See Figure H4.

### NOTICE

*Listed on 240VAC 60Hz cabin electrical panel are various labels for the circuit breakers protecting different component circuitry. A particular label does not necessarily mean your boat is equipped with this component if the component is optional. Please see your Four Winns dealer for details.*

The dockside system uses four-wire, color-coded circuitry. The black and red or hot wires are the ungrounded current carrying conductors. The white or neutral wire is the grounded current carrying conductor. The green wire, referred to as the "equipment ground," is a grounded conductor, and under normal conditions is not a current carrying wire. The neutral wires are connected together at a buss bar. The equipment grounds are similarly connected together at another buss bar. Each hot wire is connected to, and protected by, a circuit breaker in the distribution box located at the top section of the AC cabin panel identified "240VAC 60Hz".

The standard dockside system has a main circuit breaker which protects the overall distribution network. The MAIN dockside inlet with Cablemaster shore power cable storage system is located at the starboard side of the aft transom. The switch which extends or retracts the Cablemaster shore power cable is located inside the transom storage locker. See Figure H18 & H19.



**Figure H18: Dockside Inlet Location**

The respective main breakers must be turned ON and the boat must either be connected to shore power or the generator must be running for AC system operation. **Note:** An AC slide lockout is installed on the MAIN breaker switches to prevent energizing both the SHORE and GENERATOR systems simultaneously thus preventing possible damage to the electrical system.

**⚠ WARNING**

*Never override the AC slide lockout mechanism. Damage to the electrical system and possible fire and/or death could result.*



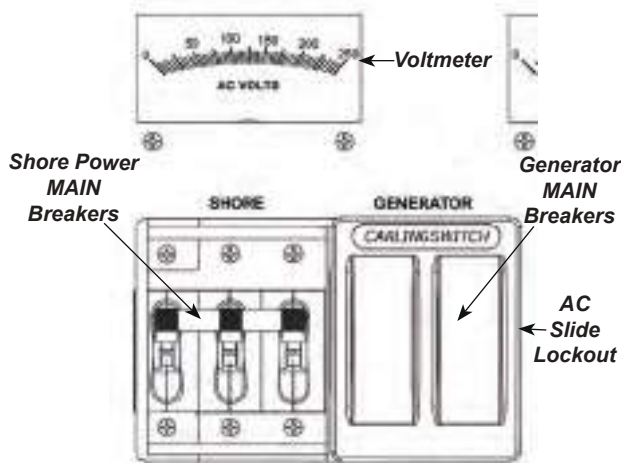
**Figure H19: Cablemaster Switch Location**

These main circuit breakers protect both the hot and neutral input leads. These breakers are sensitive. The resulting power surge which occurs when connecting the shore power cable may cause the MAIN breakers to trip. To avoid this power spike, turn OFF the SHORE breakers before connecting to the shore station power. Securely connect the boats shore power cable to the shore power station's receptacle. Once the shore power is securely connected, turn the MAIN breakers back on. If the connection is broken and later re-secured, the circuit breaker may trip. Connections must be secure for uninterrupted dockside service.

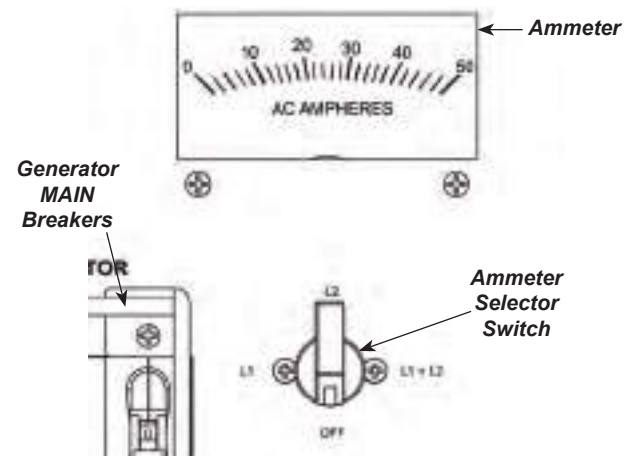
The V475 models have main circuit breakers on the 240V AC panel labeled SHORE and GENERATOR. See Figures H4 & H20.

The AC voltage for the shore power AC or generator systems may be monitored with the voltmeter in the AC panel. The SHORE or GENERATOR voltage is automatically monitored when that particular system is activated/energized. See Figure H20.

Also on the AC main distribution panel is an ammeter and on certain models an ammeter selector switch. See Figure H21.



**Figure H20: 240V AC Cabin Panel - Main Breakers**



**Figure H21: Ammeter & Selector Switch**

The ammeter measures the amount of current, in amperes, flowing through the selected circuit. Place the ammeter's selector switch to the desired circuit to be monitored (if applicable). When 120 volt equipment is turned ON the ammeter should indicate a certain amount of current flow for that particular circuit. This in turn tells you that your 120VAC equipment is working. The circuits are labeled as follows: L1 (1st Leg of 120 volt circuit), L2 (2nd Leg of 120 volt circuit) and L1 + L2 (Full 240 volt circuit). Place the switch (if applicable) to the OFF position when not in use. If the ammeter selector switch is not installed then the full 240 volt circuit is being measured. **Note:** Should you notice the SHORE (Main) circuit breakers constantly tripping; this is an indication of a problem with one of the 120 or 240 volt electrical circuits. Have the 120 volt circuits and 240 volt circuit checked by a qualified marine electrician.

Most receptacle circuits are capable of handling 15 amperes. Refer to Table III for a list of equipment and the electrical currents usually required to operate these items. For 230 volt, 50 Hertz models, divide all of the current ratings by 2. Usually, the power requirement is specified on the electrical item. This is only an approximation of the electric current usage normally experienced.

EQUIPMENT	ELECTRICAL LOADS
Air Conditioners	See motor load plate
Battery Chargers	Up to 800 watts (7.3 amps)
Blankets (Electric)	50 to 200 watts (2 amps)
Coffee Makers	550 to 700 watts (6.3 amps)
Electrical Drills	See motor load plate
Fans	25 to 75 watts (0.7 amps)
Fry Pan	1350 watts (12.3 amps)
Heater	1500 watts (13.7 amps)
Lights	Wattage as marked
Television	1500 watts (10.5 amps)
Vacuum Cleaners	See motor load plate

Table III: Electrical Equipment

## H - 8 DOCKSIDE OPERATION



*If any abnormalities appear during dockside operation, DISCONNECT the system immediately to prevent electric shock hazards! Have the boat's electrical system and the shoreside receptacles checked as soon as possible.*

### A. Shore Power Connections



*To prevent electric shock hazards, use only equipment with approved three wire electrical plug connections. Be sure each item being used has been tested and is free of electrical shorts and ground faults.*

The V475 comes equipped with a Cablemaster shore power cable storage system. This system allows one to pay out or retract the dockside power cable automatically. The system comes with a seventy-five foot, 50 amp, three-wire shore power cable. **Note:** The amount of usable dockside cable is approximately fifty feet due to 25 feet being used inside the boat for connection purposes. The cable has a "twistlock-type" connector. This connector complies with the American Boat and Yacht Council (ABYC) standards. See Figures H18 and H19.

To extend the Cablemaster shore power cable:

- 1) Flip the power switch to OUT position; grasp the power cord plug.
- 2) Walk to dock power source and plug power cord into receptacle.
- 3) Cablemaster will automatically shut itself OFF when cable has fully extended or when the momentary switch is released.
- 4) If less cable is more desirable, turn switch to the IN position.
- 5) Release switch when desired cable length is achieved

To retract the Cablemaster shore power cable:

- 1) Disconnect the power cord plug from the dock power source.
- 2) While holding power plug, walk to Cablemaster.
- 3) Turn the power switch to the IN position.
- 4) Cablemaster will automatically shut itself OFF when cable has fully retracted or when the momentary switch is released. **Do not move vessel until cable is fully retracted!**

Some marinas are not equipped with approved twistlock-type receptacles. Use only an adaptor approved by the manufacturer when an adaptor is necessary. An adaptor may be available through the dockside cable manufacturer, Marincó. Follow the manufacturer's instructions regarding its use.

 **WARNING**

*DO NOT use a two-wire adaptor to connect to a three-wire system. These adaptors do not provide adequate grounding.*

Shore power connection procedure is as follows:

1. Be sure the generator is OFF. Place the AC lockout slider over the GENERATOR main circuit breakers on the AC panel.
2. Turn OFF the boat's main (SHORE) breaker switch before connecting or disconnecting the shore power cable.
3. Connect shore power cable to dockside shore power outlet following procedure described earlier regarding extended the shore power cable.
4. Turn the SHORE main breakers at the AC cabin panel to the ON position.

To disconnect shore power:

1. Turn the main (SHORE) circuit breaker switches to the OFF position located on the AC panel.
2. Disconnect the shore power cable from the shore power dockside receptacle. Retract the shore power cable following the procedure described earlier.

 **CAUTION**

*Always remember to disconnect and retract the shore power cable first before leaving the dock. Failure to do so may lead to the damage of the shore power cable, electrical system and/or boat.*

## B. 120 Volt AC Equipment

All 12 volt equipment is isolated from the 240/120VAC system with the exception of the cockpit and galley refrigerators which are dual voltage. When AC power is supplied by either dockside power or by the genera-

tor and with the respective main circuit breakers ON, the individual circuit breakers on the panel provide protection for that specific equipment's circuitry. The receptacles can be used for 120 volt (230 volts on 50 Hertz models) household appliances. Refer to the following list for information on appliances and other equipment as well as Figure H4.

**Cockpit Refrigerator** - The cockpit refrigerator is a dual voltage appliance. The COCKPIT REFRIGERATOR breaker located on the 120VAC cabin panel must be ON to supply 120 volt power to the refrigerator. If this breaker is off, the refrigerator will automatically operate on the 12 volt system

**Cockpit Ice maker** - The cockpit icemaker is standard on the V475 models. ICEMAKER breaker located on the 240VAC cabin panel must be ON to supply 120 volt power to the icemaker.

**Electric Grill** - Allows grilling at the transom. The grill may be operated once the GRILL breaker is placed in the ON position. A safety feature includes an automatic shutoff switch when the lid of the grill is closed. Also a ground fault circuit interrupter (GFCI) is located underneath the grill.

**Battery Charger** - The battery charger is controlled by a circuit breaker on the AC electrical panel in the cabin labeled BATTERY CHARGER. In order for the charger to charge the batteries the circuit breaker must be ON while connected to dockside power. If a generator is available and operating it too will allow the batteries to be charged by the battery charger when the circuit breaker is ON.

**Water Heater** - The WATER HEATER circuit breaker supplies power to the water heater. Refer to Section J-2C - Water Heating Systems in this manual for more information.

**NOTICE**

*DO NOT supply electrical power to an empty water heater. Activate the FRESH WATER PUMP circuit breaker on the 12VDC panel to energize the water pump and prime the system when **not** connected to dockside water. Be sure there is adequate water in the system before turning on the water heater. Failure to comply will result in immediate damage to the heater element.*



**Cockpit TV** - This circuit breaker when switched ON provides power the optional cockpit TV with an electrical lift at the cockpit refreshment center.

**Galley Refrigerator/Freezer** - The GALLEY REFRIGERATOR circuit breaker must be ON to operate on 120 voltage. If this breaker is OFF, the refrigerator/freezer will automatically operate on the 12 volt system. This can deplete the battery. Excessive drain on the battery may cause irreparable battery damage. The refrigerator/freezer will automatically operate on 120 volts when provided. Refer to Section L-1C - Galley Equipment in this manual for more information.

**Electric Stove** - The RANGE circuit breaker must be activated to supply power to the electric stove. Refer to Section L-1A - Galley Equipment in this manual for more information.

**Microwave** - The MICROWAVE breaker must be energized to supply power to the microwave.

**Washer/Dryer (Optional)** - Power is supplied to the washer/dryer when the WASHER/DRYER circuit breaker is placed in the ON position.

**Vacuum** - The VACUUM circuit breaker must be activated to supply power to the vacuum.

**Forward Battery Charger** - Not applicable to the V475 with the Inboard Performance System (IPS) installed.

**Receptacles** - The OUTLETS circuit breakers supply power to the corresponding receptacles in the AC system.

**Accessories** - Additional 120 volt (220 volts on 60 Hertz) equipment may be added to the boat by wiring directly to the 240V AC cabin panel using the existing ACCESSORY circuit breakers provided. See Section H5-B -- Installation of Additional 12 Volt Equipment.\

**Air Conditioner** - The air conditioners run on a 240 volt AC system. The AIR CONDITIONER circuit breakers supply power to the air conditioners and seawater pump when placed in the ON position. A "green" LED light will appear indicating the air conditioner or seawater pump is energized. See Figure H22 for the specific names of the breakers and their area of responsibility. **Note:** The SEAWATER PUMP circuit breaker must be ON in order to operate any of the three air conditioners. Refer to Section L-5 - Air Conditioning in this manual for more information.

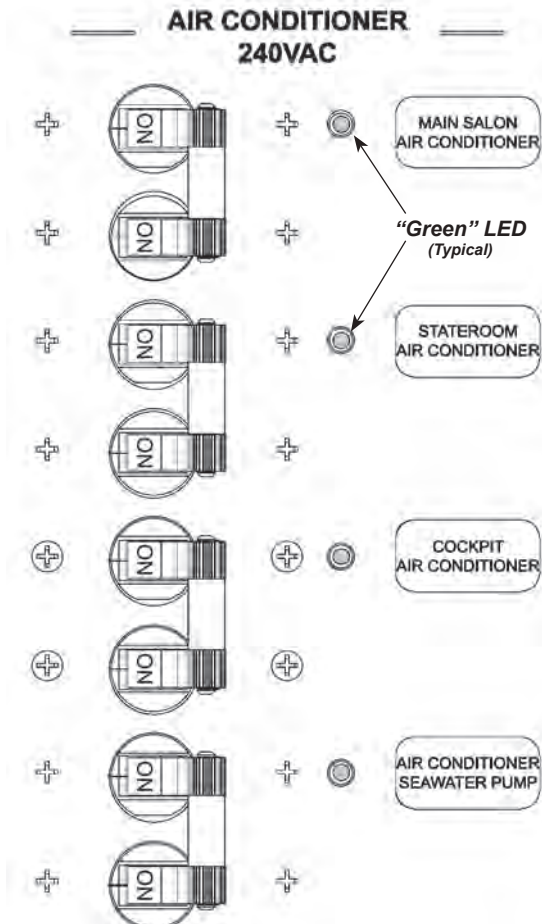


Figure H22: Air Conditioner Circuit Breakers - ON

## WARNING

DO NOT attempt installation of additional 120 volt (230 volts) equipment unless you are familiar with the proper electrical procedures involved. Failure to properly install equipment could lead to equipment damage and/or possible fire. Due to the complex nature of the electrical system Four Winns recommends that installation of any additional 120 volt (230 volt) equipment be conducted by a qualified marine electrician.

## C. Ground Fault Current Interrupters (GFCI)

The ground fault current interrupter (GFCI) is a device which protects against hazardous electrical shock from improper ground. An appliance electrical cord with worn insulation or damp equipment may have stray current which will run through electrical grounds. Stray current as above will result in an electrical shock.



One GFCI receptacle will protect all of the receptacles on the circuit. A GFCI may be used as a receptacle as well as an interrupter.

To test:

Push the black test button and the red reset button should pop out from the inner surface. The receptacle and the circuit are now off.

Push the reset button in until it clicks to reset it. If it does not reset, there is either a short in the circuit or the equipment being used, or a ground fault in the equipment. Unplug all appliances and reset the GFCI. One at a time, plug the equipment back in and turn it on. The item that causes the GFCI to trip is the problem item and should **not** be used.

## H - 9 GENERATOR

A diesel generator is standard on the V475 models. It provides 240 volt (230V) AC power when the boat is away from the dock. The generator can be operated while running at or below cruising speed. The generator should not be operated when the boat is being run at high speeds. **Insufficient cooling water may be available due to the speed.**

A generator factory installed by Four Winns is capable of providing sufficient power for most electrical needs including cooking, refrigeration, and air conditioning. **It is possible to overload the generator by trying to operate too much equipment at one time.** The circuit breaker that protects the output circuits on the generator set will trip should that occur. See the generator manufacturers information for specifications and additional details.

To use generator power, follow the procedure below:

1. Be sure the shore power cable(s) is disconnected and retracted.
2. The breaker switches for the SHORE and GENERATOR AC system must be placed in the OFF position and the AC slide lockout must be moved to cover the SHORE breakers switches. See Figure H23.
3. Place the House Battery activation switch on the 12VDC cabin panel to the ON position in order to start the generator. See Figure H17.

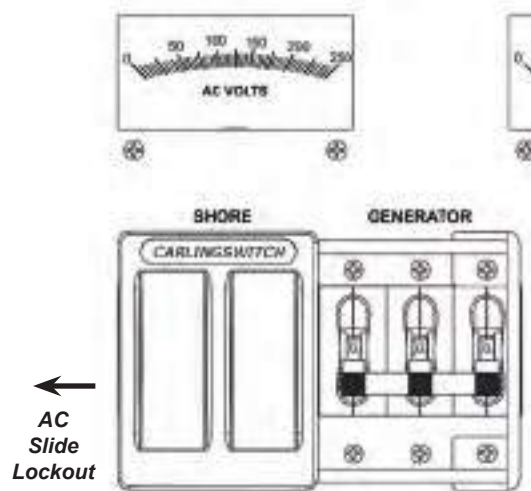


Figure H23: 240V AC Cabin Panel - Main Breakers

4. Check the bilge for fumes. Operate the blower by pressing the remote switch on the panel. Operate blower for at least 4 minutes. Verify blower operation. The "green" LED when lit signifies the blower is operating. **Note:** Follow the procedures indicated on the generator switch panel before starting generator and while running generator. See Figure H24.

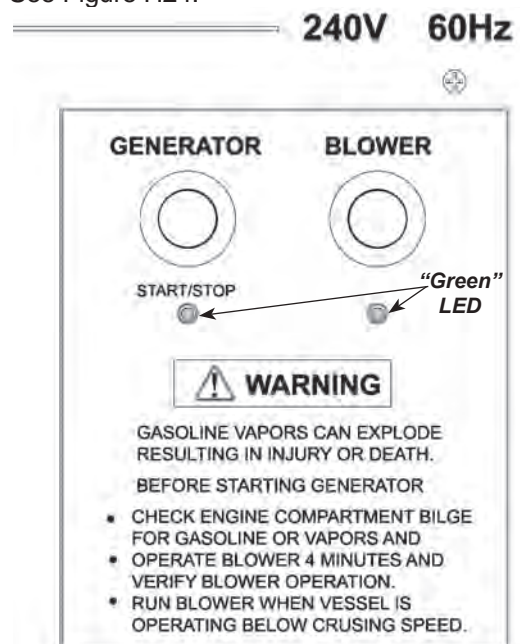
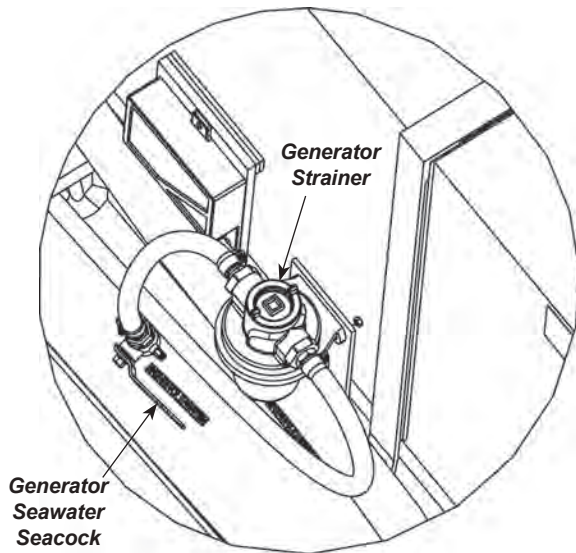


Figure H24: Remote Generator & Blower Switches

5. Open the generator's seacock valve (labeled GENERATOR SEAWATER) to allow water flow to the generator for cooling purposes. The seacock is located in the engine room next to the generator. See Figure H25.

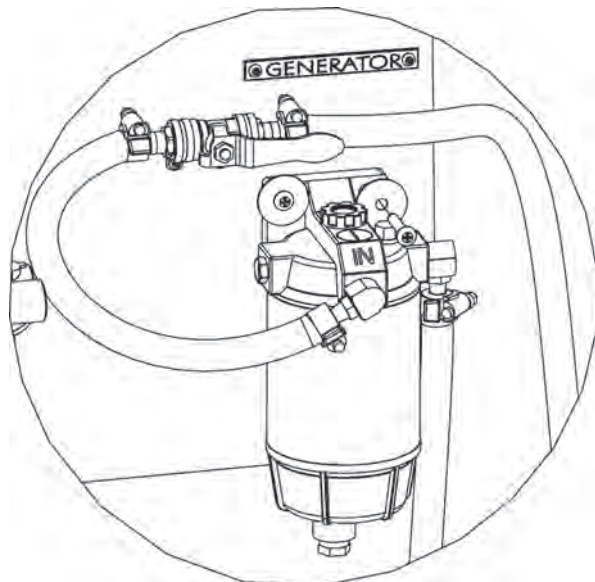


**Figure H25: Generator Seawater Seacock & Strainer**

#### NOTICE

*In order to use the generator, you must first open the seacock valve (handle parallel to the flow of valve). Failure to open seacock valve while running generator will cause generator to overheat and possible failure. When not using the generator be sure to close the seacock.*

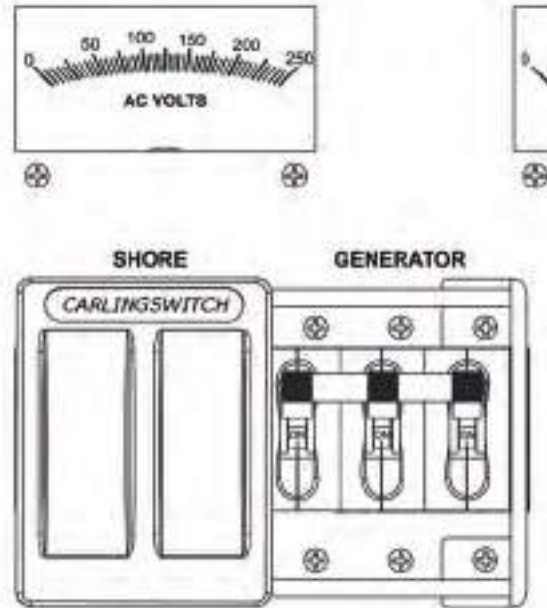
- Open the fuel valve for the generator located in the engine compartment. See Figure H26.



**Figure H26: Generator Fuel Valve**

- Start the generator using the remote generator start switch on the 240V AC cabin panel. See Figure H24.

- Turn the generator's main circuit breakers switches to the ON position. See Figure H27.



**Figure H27: Generator Main Breakers - ON**

#### WARNING

*Be sure to operate the bilge blower for at least four (4) minutes before starting engine or generator, or whenever operating the engine(s) at idle speed. Check the bilge blower output before each use.*

#### WARNING

*Generator exhaust contains carbon monoxide. Review information regarding carbon monoxide at Section B-2 - Carbon Monoxide and Section E-2 - Engine Exhaust.*

Periodic generator maintenance as outlined in the generator owner's manual is necessary. Clean the generator strainer periodically or as required. Refer to the manufacturer's literature for more information.

## H - 10 ELECTRICAL SYSTEM MAINTENANCE

### A. Battery Maintenance

Be sure to keep the batteries charged. Also, keep the batteries clean, especially the terminals and connection lugs. Be sure the batteries are fastened securely while in use.

Check the battery fluid level often, especially when a charger/converter is being used. Replenish a battery indicating a low charge. Determine the reason for the discharge. Lack of battery usage is as detrimental to battery longevity as is overuse. Alternating battery usage is important. Refer to the battery manufacturer's instructions included with your battery.

 **DANGER**

*Batteries produce hydrogen and oxygen gases when being charged. These explosive gases escape through the vent/fill caps and may form an explosive atmosphere around the battery if the ventilation is poor. This gas may remain around the battery for several hours after charging. Sparks or flames can ignite the gas and cause an explosion.*

 **WARNING****Fire or Explosion Hazard!**

*Only qualified personnel should install batteries and perform electrical system maintenance. Do not expose batteries to open flame or sparks. Do not smoke near batteries.*

 **WARNING****Poison!**

*Sulfuric acid in batteries can cause severe burns. Avoid contact with skin, eyes, or clothing. Wear goggles, rubber gloves and protective apron when working with batteries. In case of skin contact, flush with water at least 15 minutes. If swallowed, drink large quantities of water or milk. Follow with Milk of Magnesia, beaten egg or vegetable oil. Get medical attention immediately.*

 **WARNING**

*Disconnect the battery before working on electrical or ignition system to prevent electrical shock and accidental ignition.*

**B. Electrical Wiring Maintenance**

Periodically, inspect all wiring for nicks, chaffing, brittleness, improper support, etc. Check all AC and DC wiring connections to be sure they are secure and free of corrosion. Spraying the receptacles and electrical connections with an electrical connection cleaner will reduce corrosion and improve electrical continuity.

 **WARNING**

*DO NOT allow corrosion to build up on connections. Shorts or ground faults can result.*

The entire 240/120 (230) volt circuitry, especially the shore power cable, should be seasonally tested for proper continuity by an experienced marine electrician. This will help detect any short, open wire, or ground fault.

 **WARNING**

*240/120 (230) volt AC electrical power can be dangerous. DO NOT attempt to service a system unless you are familiar with, and experienced in, performing such service.*

Periodically, inspect the exterior jacket of your shore power cable for nicks or cuts. Experience has shown that when only a short section of the power cable is regularly used, the cable may be subject to sharper than normal coiling which in turn causes undue "kinking" of the cable. To relieve this condition, routinely pay the cable out completely and stretch it on any smooth surface. Allow the Cablemaster to then retract the cable into the cable storage area. Check the neoprene covers on the in-limit switch and power switch to be sure they are free of cracks or fracture. If your shore power cable is dirty DO NOT USE any cleaner that will leave a waxy film on the shore power cable. The waxy film will cause slippage between the Cablemaster's main pulley and your shore power cable. It is recommended to use a mild soap and water to clean your cable.

## H - 11 STRAY CURRENT CORROSION

### A. General

Electrically induced underwater corrosion occasionally affects boats and their related components. This is referred to as “Stray Current Corrosion” and appears as surface pitting or deterioration. Stray current corrosion is the decomposition of chemical compounds by electric current.

Stray current corrosion can be caused by surrounding boats; an improperly wired battery/charger installation or other boats that are in close proximity which have electrical power leakages. Stern drive units are especially vulnerable to stray current corrosion.

Periodically inspect the engine components to determine if corrosion damage exists. If stray current corrosion damage is found, determine and correct the cause of the stray current to prevent further damage. Consult an experienced marine electrician or contact your Four Winns dealer for assistance.

The use of some shore power battery chargers, while the boat is in the water and the battery is connected to the system, can cause stray current corrosion. Have an experienced marine electrician review any battery charger installation to ensure a stray current corrosion problem will not develop. An improper battery connection is a common cause of stray current corrosion.

#### **NOTICE**

*Use only UL Marine-ignition protected battery charger(s) designed to meet US Coast Guard regulations for external ignition protection.*

Corrosion is usually more prevalent in polluted or salt water than in fresh water. It is also more likely to occur when dockage is in an area with steel piers, large metal boats, or where shore power is in use.

### B. Galvanic Corrosion

Galvanic corrosion results from a potential electrical difference existing between dissimilar metals immersed in a conductive solution (e.g., salt or brackish water). If these metals touch or are otherwise electrically connected, this potential difference produces an electron flow between them. The attack on the more active metal is usually increased and the attack on the less active metal is decreased, as compared to when these metals are not touching.

### C. Corrosion Prevention

Anticorrosion anodes are attached to the transom to prevent corrosion to your electrical systems and underwater parts. These anodes will be slowly eroded away by galvanic action and require periodic inspection. Please refer to the section on “Anti-Corrosion Anodes” in your engine manufacturer’s manual for additional information.





**I - 1 DIESEL FUEL SYSTEMS**

The diesel fuel system used in the V475 is designed to meet or exceed the requirements the National Marine Manufacturers Association and the American Boat and Yacht Council in effect at the time of manufacture.

**NOTICE**

*Use only clean, dry fuel of the type and grade recommended by the engine manufacturer. The use of incorrect or contaminated fuel can cause engine malfunction and serious damage. Engine damage resulting from the use of incorrect fuel is considered misuse of the engine and will void the engine warranty. Refer to the section on Fuel Requirements in the engine manual for information on fuel specifications.*

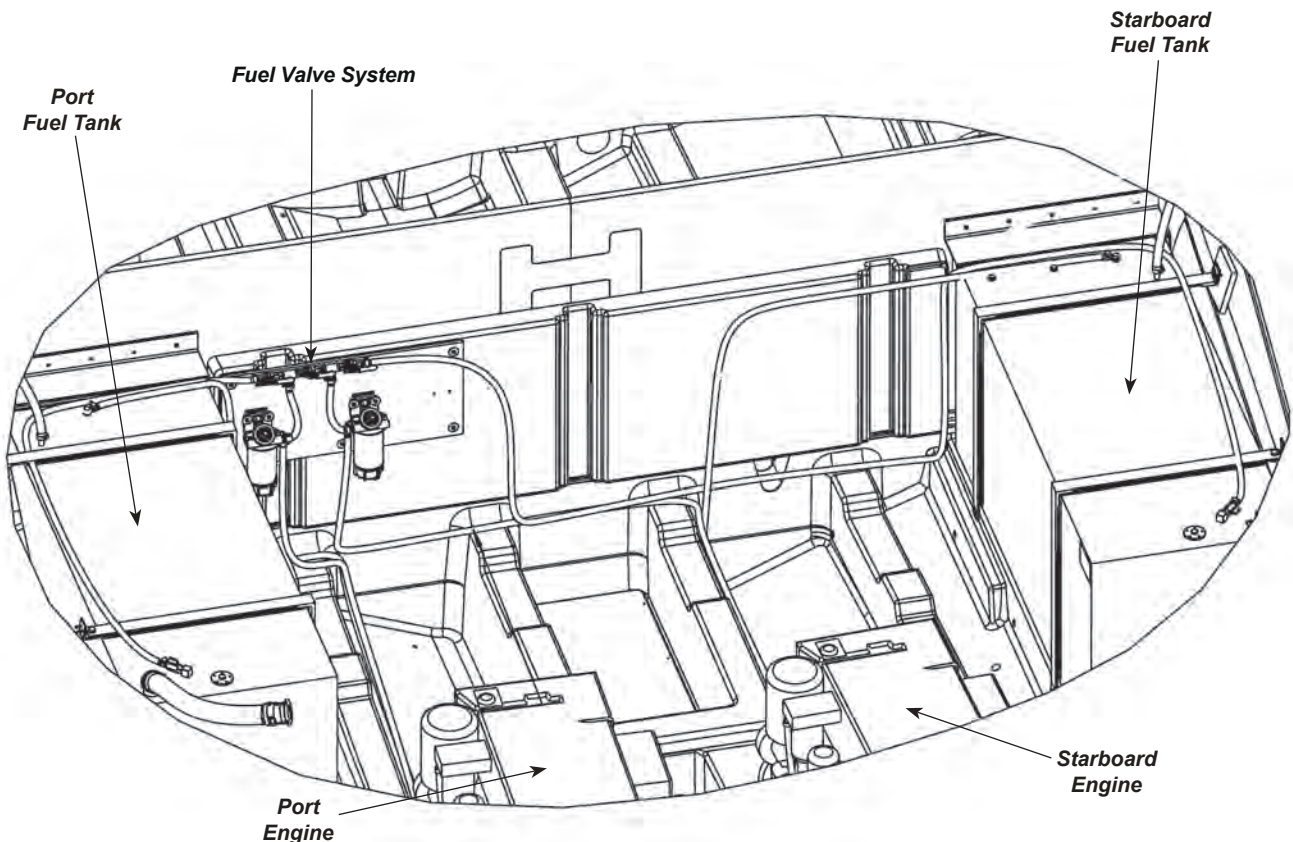
In twin engine applications, the port and starboard fuel tanks are located forward and outboard in relationship to their respective engine. See Figure I1. The capacity of the fuel tank(s) may be found on our website at [www.fourwinns.com](http://www.fourwinns.com).

The V475 models are equipped with twin fuel tanks and come with a manual fuel valve system. See Figure I1. This fuel valve system allows you to manually select which fuel tank you want your engines to draw fuel from. The diesel generator uses a separate fuel pick-up (not shown). Please see Figures I9 and I10 at the end of this section for fuel valve components listing and operations.

**A. System Testing**

All fuel systems have been factory inspected and pressure tested in accordance with regulations in effect at the time of manufacture. Additionally, each fuel tank must pass rigid tests and inspections performed by the fuel tank manufacturer.

Prior to taking delivery, it is important that a full inspection be made of the entire fuel system by the selling dealer. An entry on the Four Winns Pre-Delivery Inspection Form portion of the Warranty Registration Card will attest to the dealer's performance of this service.

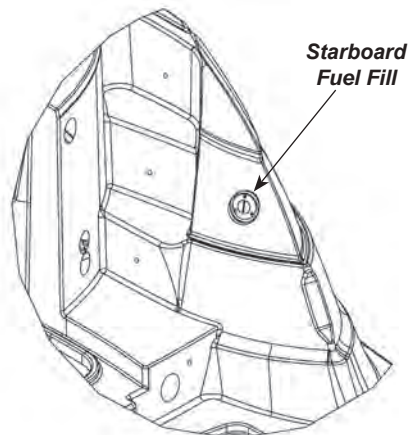


**Figure I1: Twin Fuel Tank Locations**



## B. Fuel Fills

The fuel fill deck plates are located on the port and starboard at the transom and are marked “DIESEL”. See Figure I2. Be sure to utilize the proper type and grade of fuel as recommended by the engine manufacturer. To open, insert the deck plate key into the holes on the cap and rotate counterclockwise. A bead chain connects the cap to body to help prevent loss overboard. Refer to Section I-2 for information regarding fueling instructions.



**Figure I2: Starboard Fuel Fill Location (Port & Stbd Typical)**

**WARNING**

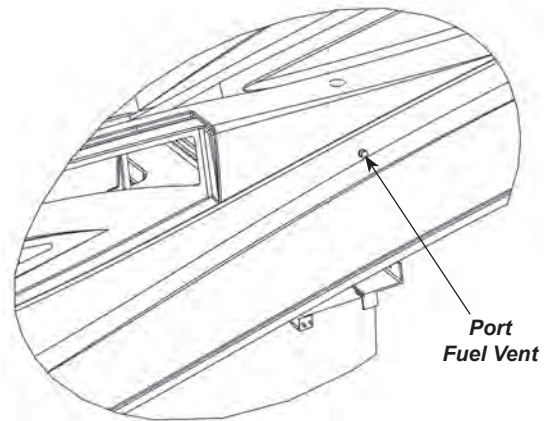
*DO NOT confuse FUEL deck fill plate with WATER or WASTE deck plates. Deck fill plates are labeled according to the intended use.*

The gasket/O-ring seals on the fuel fill cap assist in sealing when closed. A missing or damaged O-ring can allow water on the surrounding surfaces to run into the tank.

Periodically inspect the cap and the fuel deck plate. The O-ring seal should be inspected for cracks or damage and replaced as necessary. Lubricating with a light, waterproof oil or grease is recommended and can extend the O-ring's longevity.

## C. Fuel Vents

On the V475 separate thru-hull fuel vents are installed. See Figure I3. While the tank is being filled, the air displaced by the fuel escapes through the vent overboard.



**Figure I3: Port Fuel Vent Location (Port & Stbd Typical)**

**WARNING**

*Spilled fuel is a fire and explosion hazard. DO NOT overfill or overflow the tank, or allow fuel spills into the hull or bilge. If spillage occurs, clean up immediately and dispose of soiled rags/towels in a proper container.*

**WARNING**

*Avoid overboard spills. When tank is almost full the sound from the fuel vent will change. The pitch will become higher indicating the tank is close to being full. Stop pumping fuel into tank. Do not top off.*

**NOTICE**

*When fueling at a marina, DO NOT overfill. Fuel may spill into the water.*

After fueling, replace the fill cap, and wash the areas around the fuel fill plate and below the fuel vent. Residual fuel left on the deck and hull sides can be dangerous, and will yellow the fiberglass. It will also damage the tape stripes and logos.

For those models with thru-hull venting, periodically, inspect the fuel vent(s) for any dirt, wax, etc. Carefully remove any obstruction with a pipe cleaner or similar device. **Be sure not to puncture the screen.** The vent screens are designed to keep insects and foreign matter from contaminating the fuel and fuel system. The stainless steel cap is not removable.

### D. Fuel Pick-Up

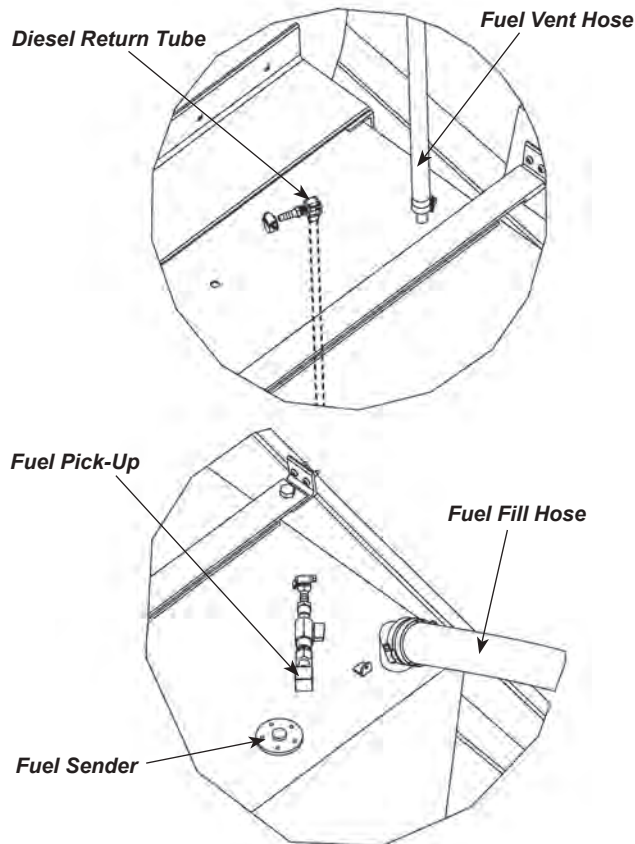
The fuel withdrawal line attaches to the fuel tank at the fuel pick-up. See Figure I4 for fuel pick-up location.

**CAUTION**

The fuel withdrawal is positioned in the fuel tank to achieve optimum fuel usage, and fuel line routing. At certain speeds and hull trim angles, the fuel supply at the withdrawal can increase or decrease accordingly. Be extremely careful when attempting to operate the boat on a minimum amount of fuel. Though some fuel may be in the tank, the relative trim angle of the boat may cause the fuel to flow away from the withdrawal.

**NOTICE**

On the V475 models, access to the fuel fittings is through the engine compartment.



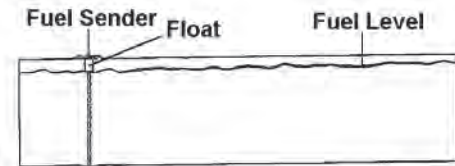
**Figure I4: Starboard Fuel Tank Fittings Shown (Port & Stbd Typical)**

### E. Fuel Level

The amount of fuel in the fuel tanks can be accessed through the Electronic Vessel Control (EVC) system. An EVC display for each engine is mounted at the helm and monitors their respective systems to include fuel level. Refer to the manufacturer's literature included in your owner's packet for specific information regarding ECV operation and information display.

### F. Fuel Senders

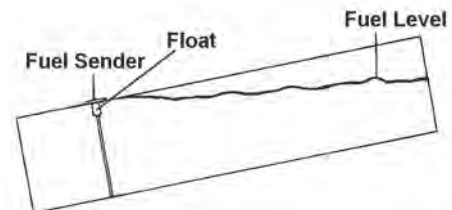
The fuel sender consists of a float which travels up and down a stationary tube. The float measures the level of the fuel in the tank and sends a signal to the EVC display. See Figure I5.



**Figure I5: Fuel Sender Operation**

Due to the mechanical nature of the fuel sender, variations in readings during various speeds of operation may occur. This system is merely a relative indication of the available fuel supply and not a calibrated instrument. With this type of sending unit a more accurate measurement of fuel level is obtained with the boat in a level position.

The display readings will also vary with the trim angle of the boat. When sitting at a dock and the boat is nearly level, the fuel display will register accurately. Refer to Figure I3. When boating, the trim angle of the boat changes and affects the gauge readings. Under these conditions, the fuel sender will register "full" for the first few hours of running time until the fuel level drops below the 3/4 or 1/2 mark. This is caused by the angle of the fuel in the tank as shown in Figure I6.

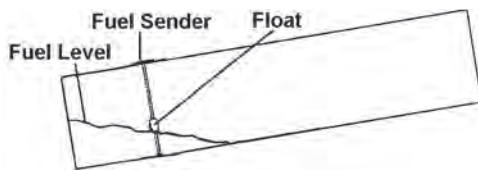


**Figure I6: Effects of Trim Angle**

It is very important to keep track of hours and fuel consumption to obtain an average gallon per hour consumption figure. Note: The EVC display can be set to show the fuel consumption rate. Use the fuel log located at the back of this manual to assist in keeping track of the fuel consumption rate. This will assist in preventing any problems with running out of fuel on the water.

Dealers are equipped with some general figures on consumption which can be used as a guide until specific information on your boat is determined. Because of boating conditions, speed, weight and other factors common to your situation, fuel consumption will vary between your boat and consumption figures developed by Four Winns.

When the fuel begins to register below the “full” mark, the display readings will drop much faster until it reads “empty”. When this occurs, the trim angle has affected the sender reading. When the display registers “empty”, the sender has bottomed out and there may be 3 to 4 gallons of fuel in the tank. See Figure I7.



**Figure I7: Trim Angle Effect with Low Fuel**

## G. Fuel Filters

Fuel filters are installed on each engine. Filters should be changed frequently to assure an adequate supply of fuel to the engine. Refer to the engine manual for maintenance schedule as well as the procedure for changing the fuel filter. The engine manual is included in the owner’s information packet.

### **WARNING**

*DO NOT attempt installation or maintenance of any fuel system equipment unless thoroughly familiar with the systems and experienced in making such installations or maintenance. Only qualified personnel should perform fuel system maintenance.*

## H. Use and Maintenance

### **WARNING**

*DO NOT let the odor of fuel go unchecked. If the odor of gasoline is noted, DO NOT START ENGINE. If engine is running, SHUT OFF ENGINE, ELECTRICAL AND HEAT GENERATING EQUIPMENT. Investigate and correct the situation immediately! Have all passengers put on personal flotation devices and keep fire extinguishers at hand until the situation is resolved.*

### **WARNING**

Avoid serious injury or death from fire or explosion resulting from leaking fuel. Have fuel system inspected for leaks, check conditions of all rubber hoses and re-tighten hose clamps every 200 hours or at least once a year by an authorized Volvo Penta service facility.

If areas are found within the fuel system that appear questionable, have a qualified marine technician inspect the system. A thorough fuel system examination should be made by an experienced marine technician at least once a year.

### **WARNING**

*To help guard against damage, avoid the storage or handling of gear near the fuel lines, fittings and tanks.*

## I - 2 FUELING INSTRUCTIONS

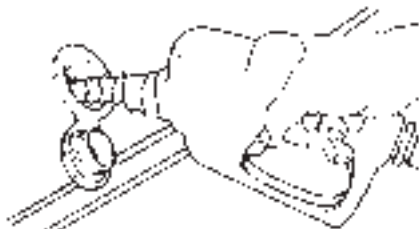
1. Avoid fueling at night except in emergencies.
2. When moored at fueling pier:
  - a. Do not smoke, strike matches, or throw switches.
  - b. Stop all engines, motors, fans, and devices that could produce sparks.
  - c. Put out all lights and galley stove.
  - d. On the DC cabin panel place the HELM MAIN and CABIN MAIN breaker switches to OFF position.

3. Before starting to fuel:

- a. Ensure that boat is moored securely.
- b. Close all ports, windows, doors and hatches.
- c. Be sure the proper type and grade of fuel as recommended by your engine manual is used.
- d. Determine how much additional fuel is required to avoid overflow.

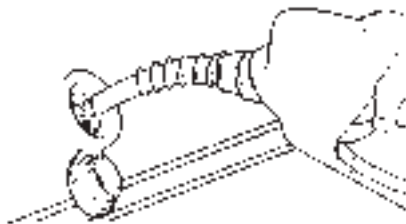
4. During fueling:

Keep the fill nozzle in contact with the fuel opening at all times to guard against possible static spark or spill. See Figure I8.



Grounding the fuel hose - Proper

(Nozzle in contact with fuel opening - Correct)



Not grounding the fuel hose - improper

(Nozzle not in contact with fuel opening - Incorrect)

**Figure I8: Grounding Fuel Hose**

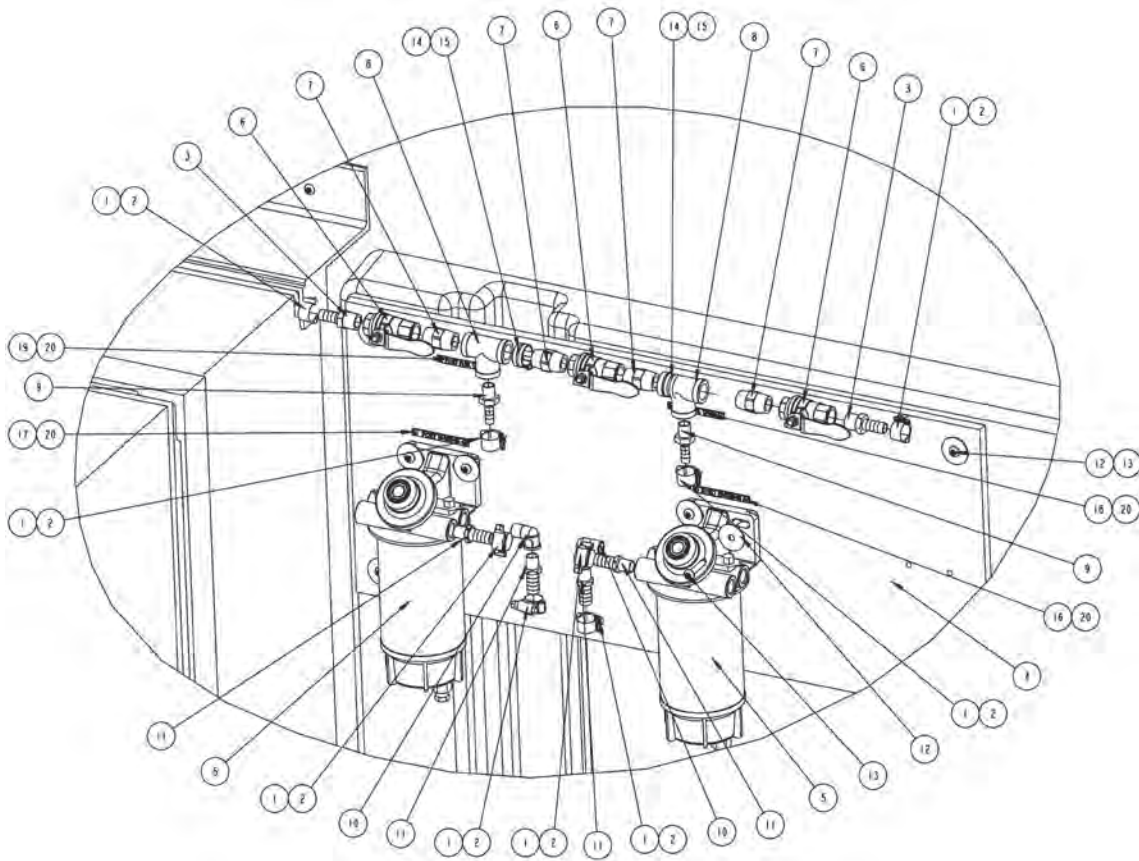
 **WARNING**

*Spilled fuel is a fire and explosion hazard. DO NOT overflow the tank or allow fuel spills into the hull or bilges. Avoid overboard spills. When tank is almost full the sound from the fuel vent will change. The pitch will become higher indicating the tank is close to being full. Stop pumping fuel into tank. **Do not top off.***

5. After fueling:

- a. Replace all fill caps securely.
- b. Wipe up any spilled fuel.
- c. Open all ports, windows, doors and hatches.
- e. Determine that there is no odor of fuel in the engine compartment or below decks before starting machinery, turning on lights or lighting stove. Operate the bilge blower system for at least four (4) minutes before engine start-up.
- f. Be prepared to cast off moorings as soon as engines are started.



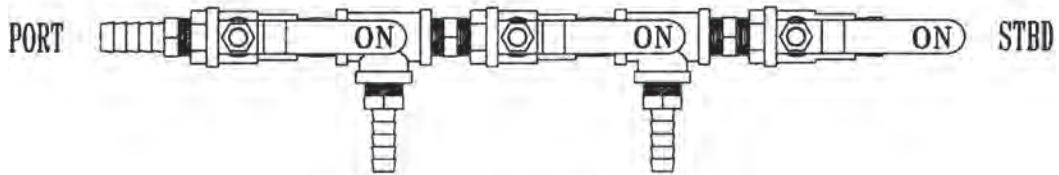


#	DESCRIPTION	PART No.	QTY	U/M
1	CLAMP, 3/8" HOSE #67065-52	021-0034	8	EA
2	BOOT, HOSE CLAMP	030-0864	8	EA
3	ADAPTER, 1/2" NPT MALE X 1/2 HB	021-0474	2	EA
4	MOUNT, FUEL MAINFOLD 378V	100-60720	1	EA
5	FILTER, FUEL, WATER SEPARATOR #490WANT	021-0528	2	EA
6	FUEL VALVE, 1/2" NPT FULL FLW01	021-0440	3	EA
7	COUPLING, 1/2 NPT MALE UNION	021-0521	4	EA
8	TEE PIPE 1/2" X 1/2" X 1/2" BRONZ 01	021-0443	2	EA
9	HOSE BARB 1/2 MP X 3/8 #220EF	021-0022	2	EA
10	ELBOW STREET 90 DEG 3/8" BRONZE	021-0452	2	EA
11	HOSE BARB, 3/8 MP X 3/8	021-0020	4	EA
12	WASHER, 1/4" X 1-1/4" FLAT FENDER	080-0159	10	EA
13	SCREW, #14 x 1-1/2" PPHSMS	080-0043	10	EA
14	CLAMP, LOOM NC12	080-0279	2	EA
15	SCREW, #8 x 1/2" PPHSMS BLACK	080-0024	2	EA
16	PLATE, STBD ENGINE	056-0112	1	EA
17	PLATE, PORT ENGINE	056-0113	1	EA
18	PLATE, STBD FUEL TANK	056-0111	1	EA
19	PLATE, PORT FUEL TANK	056-0110	1	EA
20	SCREW, #6 x 1/2" PPHSMS	080-0010	8	EA

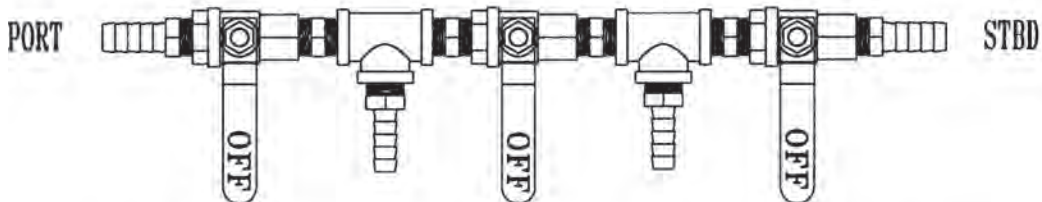
**Figure I9: Fuel Valve System Components**

**NOTE: GENERATOR OPTION HAS SEPARATE FUEL PICK-UP.**

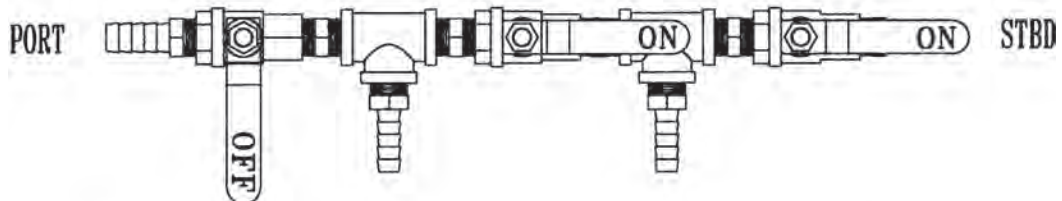
**PORT ENGINE AND STARBOARD ENGINE DRAWING FROM BOTH FUEL TANKS.**



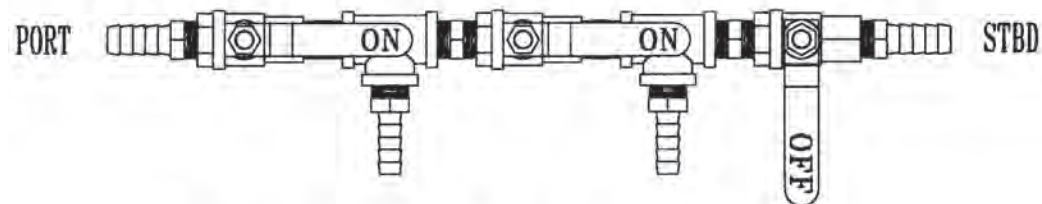
**FUEL SYSTEM COMPLETELY CLOSED.**



**PORT ENGINE AND STARBOARD ENGINE DRAWING FROM STARBOARD FUEL TANK.**

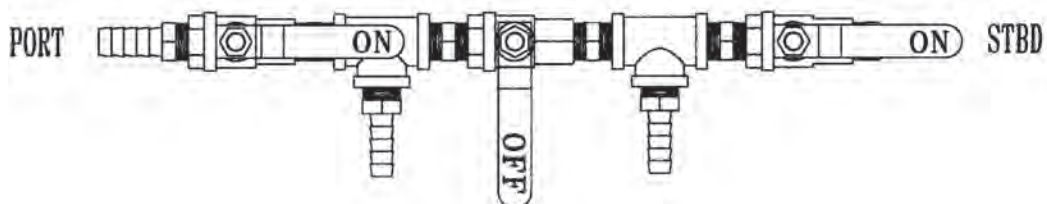


**PORT ENGINE AND STARBOARD ENGINE DRAWING FROM PORT FUEL TANK.**



**1) PORT ENGINE DRAWING FROM PORT FUEL TANK.**

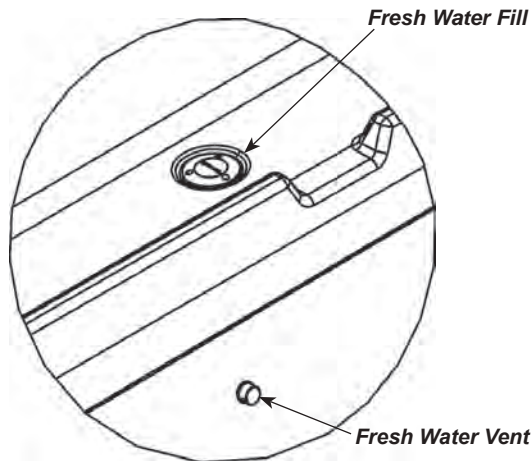
**2) STARBOARD ENGINE DRAWING FROM STARBOARD FUEL TANK.**



*Figure 110: Fuel Valve System*

**J - 1 GENERAL**

All Four Winns V Series models are equipped with a fresh water supply system. This system consists of a water supply tank, water distribution lines and a distribution pump. The water fill deck plate for the fresh water system is located on the deck and labeled accordingly. Always fill the tank slowly. See Figure J1 and the locator drawing at the back of the manual for location.



**Figure J1: Fresh Water Fill & Vent**


**CAUTION**

The water deck plate is appropriately labeled. **DO NOT** fill the system with anything other than water. Should the system become contaminated with fuel or other toxic solution, component replacement may be necessary.

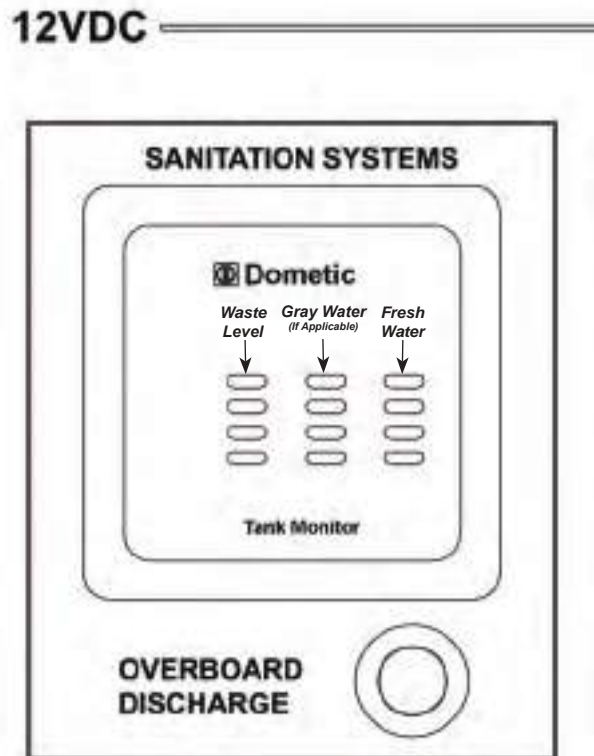
The water tank is equipped with an overboard vent (Figure J1). Maintain a close visual watch on the overboard vent while filling the water tank. Always fill the tank slowly. When the tank is almost full, water will spurt out of the vent.

**NOTICE**

When filling the tank, never seal the hose to the deck plate. The tank will become pressurized and could rupture.

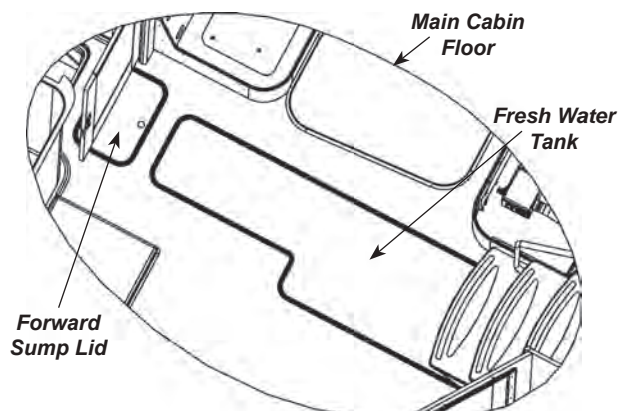
**DO NOT** overfill the water tank. Tank damage may result. Water capacity and tank location may vary due to other equipment that may be installed on the boat.

For the potable water capacity, please refer to our Four Winns website at [www.fourwinns.com](http://www.fourwinns.com). Tank monitoring systems are standard on the V475 model. These indicators are located on the 12VDC panel for monitoring the water/waste levels. Refer to Figure J2. Included in the owner's packet is the manufacturer's literature regarding the level indicators and their functions.



**Figure J2: 12VDC Cabin Panel - Sanitation Systems**

Also refer to the locator drawing in the back of this manual for the fresh water tank location. Access to the tank is gained through the fresh water lid located in the main cabin's floor. See Figure J3.



**Figure J3: Fresh (Potable) Water Tank Lid Location**



The materials from which the components of the water system are made may give the water supply a peculiar taste, especially when new. This condition is normal and can be reduced somewhat through the use of a water filter; such as that produced by Shurflo, LLC. The taste will completely dissipate in time.

 **WARNING**

*The fresh (potable) water system should be disinfected prior to initial use.*

The water system should be disinfected before first use and at the beginning of each season. The following information is a general guide to disinfecting the fresh water system.

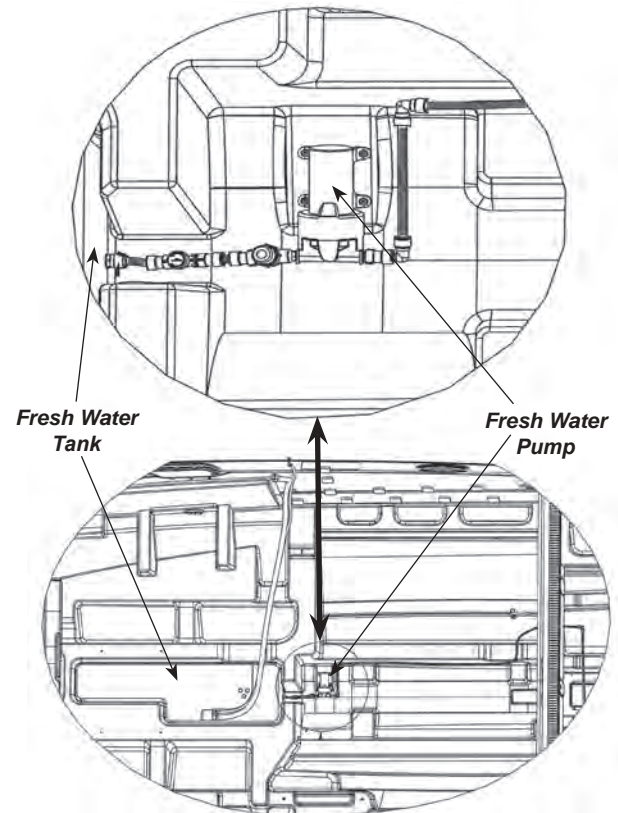
1. Flush the boat's water system thoroughly with fresh water. Make sure all nontoxic antifreeze is removed from the system.
2. The water system should be drained completely.
3. To disinfect the water system, use one gallon of water and 1/4 cup of Clorox™ or Purex™ household bleach (5% sodium hypochlorite solution). This is recommended for each 15 gallons of tank capacity.
4. Allow to stand for three (3) hours. If time is a factor, greater concentrations of chlorine solution will be needed to disinfect the water system.
5. Drain the system.
6. Flush the system thoroughly with fresh water.
7. Fill the system with fresh water.

To remove excessive chlorine taste or odor which might remain in the system, prepare a solution of one quart vinegar to five gallons water and allow this solution to agitate in the tank for several days during boating. Then drain tank and refill with fresh water.

All drains are equipped with traps, and the water will drain slowly. If the system is not operating properly, have it checked by your authorized Four Winns dealer.

## J - 2 PRESSURIZED WATER SYSTEM

The water pump is an automatic, on-off, self-priming pump that can service several outlets at once. The pump will build up water pressure and will turn off when it reaches 60 psi. Refer to Figure J4.



**Figure J4: Fresh Water Pump & Location**

### A. Priming the System

After filling the water tank, open all faucets partially. Activate the FRESH WATER circuit breaker switch on the cabin 12VDC cabin panel to supply the system with water. Let the pump run until water comes out of the galley faucet, transom shower, head faucets and showers.

After all the air has been purged from the system and a steady flow of water is coming from each outlet, turn off the faucets one by one. Begin with the cold water faucets and continue until all faucets are shut off. As the pressure builds, the pump will automatically shut off at 60 psi. Refer to Section H-5 - 12 Volt Electrical Equipment and the manufacturer's literature included in the owner's packet for additional information.



## B. System Operation

When properly primed and activated, the pressurized water system can be used in the same manner as the water system in a home. An automatic pressure sensor in the water pump keeps the system pressurized. Simply turn on the faucet and water will be delivered. If the system has been recently filled, or has not been used for an extended period of time, air bubbles may accumulate at the pump and/or in the waterlines. If this should happen, re-priming may be necessary. Refer to the preceding subsection regarding priming the system.

To obtain the most consistent mixture of hot and cold water, turn the cold water on full, then mix in hot water until the desired temperature is obtained. If water pump cycling occurs, some minor variations in water temperature can be expected.

Whenever the boat will be left unattended for an extended period, the FRESH WATER PUMP circuit breaker switch should be turned to the OFF position. This switch should also be turned OFF whenever the water tank is to remain empty for an extended period of time.

## C. Water Heating Systems

A water heater is a standard feature on the V475 models. The capacity of the water heater may be found on our website at [www.fourwinns.com](http://www.fourwinns.com). Refer to Figure J5 and the locator drawing at the back of the manual for the location of the water heater.

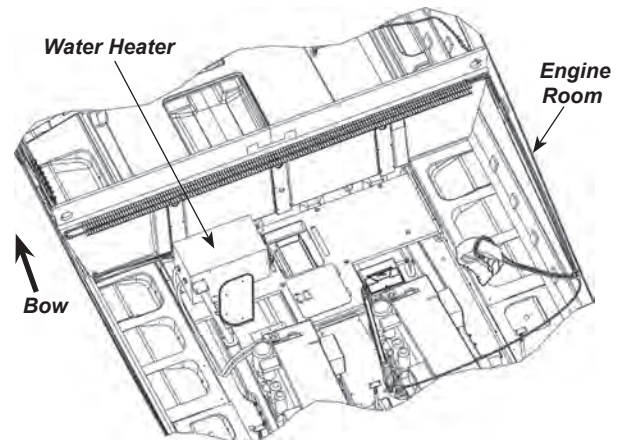
### NOTICE

*Water heater location may vary due to the installation of optional equipment.*

The water heater utilizes 120 volt (230 volt on 50 Hertz models) power. The water heater breaker switch is located on the cabin 240V AC cabin panel.

### NOTICE

*DO NOT supply 120 volt (230 volt) power to an empty water heater. Damage to the heater will result **immediately**. The water system must be filled and primed before attempting to use the water heater.*



**Figure J5: Water Heater Location**

On the V475 models the water heater incorporates a heat exchanger. The heat exchanger allows the engine coolant to quickly heat a portion of the fresh water supply while the engines are operating. This provides hot water at times when 120 volt power is not available. Additional information on heat exchangers is discussed in the hot water heater manufacturer's manual. Please refer to Section H on Electrical Systems for additional information.

## D. Using The Forward & Aft Showers

Turn on the shower by lifting up on the shower handle. Rotate the shower handle position to obtain the desired temperature. The shower head is designed to be hand-held. If desired the shower sprayer may be removed from its holder position and used. This hand-held feature allows for greater ease of use and efficiency. When showering has been completed, turn the shower handle to the off position and place the shower head back onto its holder (if applicable). Note: height of the shower holder for the forward head may be adjusted for convenience.

When using the shower, draw the shower curtain closed before using the shower. Damage to the finish can result if surrounding walls and flooring are allowed to become excessively wet. Thoroughly dry these areas after showering.

### CAUTION

*The water temperature can vary during shower use as the pressure pump cycles on and off.*

Shower sumps and sump pumps are incorporated into the drain systems of the showers. The shower drains into either the forward or aft sump respectively. The sumps are located forward or aft of the fresh water tank.

The sump pump circuitry is protected by circuit breakers located on the aft circuit breaker panel and on the 12VDC cabin panel. The sump pump includes an automatic float switch. The sump pump will automatically start as soon as the water in the sump reaches a level that causes the float on the switch to rise. The gray water is then pumped overboard through thru-hull fittings or into the gray water holding tank (if installed).

After showering, let the water flow for a period of time to flush the pump of soap residue. Check the sump for excess residue periodically. When rinsed out, the pump will automatically shut off.

If water flow from the shower head appears to be restricted, it may be due to sediment accumulating at the shower head. If necessary, remove the shower head and clean the discharge holes with a fine wire. Periodically check the sump pump screen for clogs to prevent drainage problems from occurring in the shower drain. Refer to the manufacturer's literature included in the owner's packet.

### J - 3 GRAY WATER SYSTEM OPTION

This feature (if installed) allows the water from the galley sink, head sinks and showers to drain into their respective sumps which is then pumped into a gray water holding tank. See Figure J6. The gray water level indicator is located on the 12VDC panel. A pumpout fitting labeled WASTE but designated for gray water is provided on the deck. See the locator drawing at the back of the manual for the fitting location.

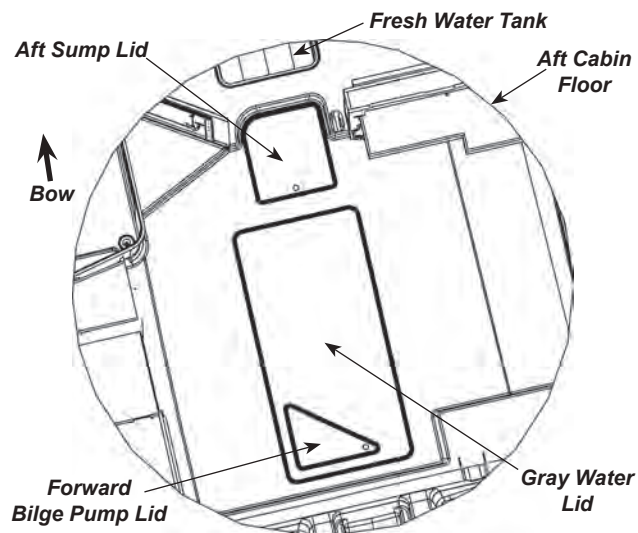


Figure J6: Gray Water Lid Location

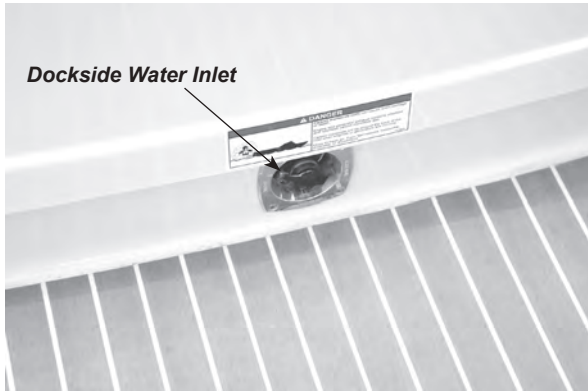
#### NOTICE

*Certain geographical areas have restrictions on gray water being pumped or drained overboard. Be sure to check all local, state and federal laws in the boating area.*

### J - 4 SHORE WATER CONNECTION

Shore water connection is standard on the V475 models. This feature allows the direct connection of a city or shoreside water supply to the boat's water system to provide a constant supply of fresh water without the need to constantly refill the water supply tank. This minimizes pressure pump operation thus extending the life span of the pump.

Dockside shore water pressure can vary dramatically. Excess pressure could damage the boat's water system so the shore connection also regulates the water pressure to a maximum of 35 psi. The shore water inlet/regulator fitting is located outboard, center of the transom, just above the swim platform. See Figures J7.



**Figure J7: Dockside Water Inlet Location**

To use shore water, connect a hose from the shore water faucet to the shore water fitting on the boat and turn ON the shore water. The water system of the boat will then be pressurized by city water if the system was previously primed.

The FRESH WATER PUMP circuit breaker switch located on the 12VDC cabin panel should be turned OFF when using city water. If the pump is OFF, the pump will not function and the water in the storage tank of the boat will not be utilized.

#### NOTICE

**Always** remember to disconnect the shore water supply hose before leaving the dock, otherwise damage to the dockside inlet and/or boat may occur.

**Always** turn off the shore water whenever the boat is left unattended. If a major water leak did occur and went undetected, the boat could fill with water and sink.

**DO NOT** alter or repair the pressurized water system or shore water connection without having proper knowledge of the system. Damage to the water system can occur.

See Section J-1 for general water system information and instructions on filling the water tank. **Note:** The fresh water tank will not be filled while connected to shore/city water.

### J - 5 TRANSOM SHOWER

The transom shower with a choice of hot/cold water is standard. The shower unit is located on the starboard side of the transom. Refer to Figures J8 & J9.



**Figure J8: Transom Shower**



**Figure J9: Transom Shower Location**

The water supply system can be used for showering or washing down the transom area. As long as there is water pressure, the shower sprayer will operate. Fresh water tank capacity is limited. Connect the boat to shore water before using large amounts of water as required when washing down the transom/swim platform area.

### J - 6 BOW WASHDOWN

In the anchor locker, a speed-tap washdown fitting is flush mounted into the deck. See J10. The tap incorporates an automatic shut-off valve for ease of use. The speed tap has a quick connect feature that allows you to attach your hose rapidly which makes it convenient for rinsing off your anchor and chain. The hose and spray nozzle may be stored in the transom storage locker.

It operates much like the transom shower with the exception of no hot water availability. As stated earlier fresh water tank capacity is limited. Connect the boat to shore water before using large amounts of water as required when washing down the bow and deck area of the boat.





Figure J10: Bow Washdown w/ Quick Connect Hose

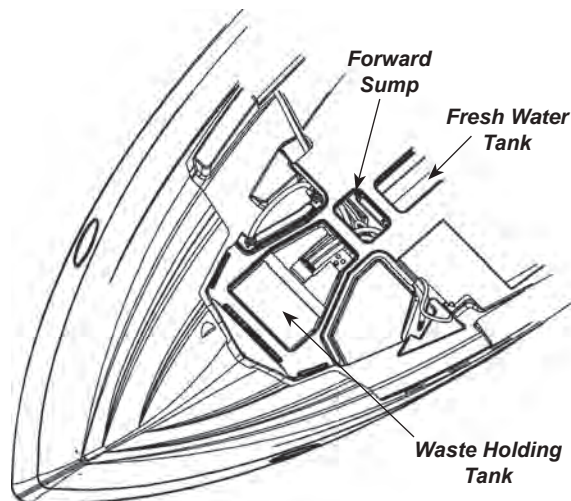


Figure J11: Waste Holding Tank Location

## J - 7 WASTE SYSTEM

The various anti-pollution laws presently in effect have necessitated the use and availability of a wide variety of toilets. The toilets installed in the forward and aft heads are the same. They have been chosen to provide proper fit, reasonable longevity and reliable service, at a realistic cost. Refer to the manufacturers literature included in the owner's packet for additional information regarding your particular toilet.

### A. Sanitation System

The toilets obtain their flush water from the fresh water system. Fresh water is the key to an odor free bathroom compartment. This system eliminates the unpleasant sulfide odors which plague saltwater systems. Flush water is no longer drawn through the through-hull fittings, seacock, and vented loop. It also extends the life of the system components by eliminating salt water and impurities from accumulating in the system over time. **Note:** The fresh water system is protected from any possible contamination from the waste system.

The toilets are optimized for minimal water use. The approximate amount of water used per flush is as follows: 3.7 pints/1.75 liters for liquid waste and 4.75 pints/2.25 liters for solid waste. Lock-out electronics is another notable feature which prevents flushing if the waste holding tank is full. Circuit breakers which protect the forward and aft toilet circuits are located on the 12VDC cabin panel and are labeled accordingly. The location of the waste holding tank is in the floor of the master stateroom. See Figure J11.

The following basic toilet operations are discussed. Consult the toilet manufacturer's owner's manual for complete details regarding the toilet operations as well as maintenance.

#### Toilet Operation:

The toilet's wall switch control has two primary functions. See Figure J12.

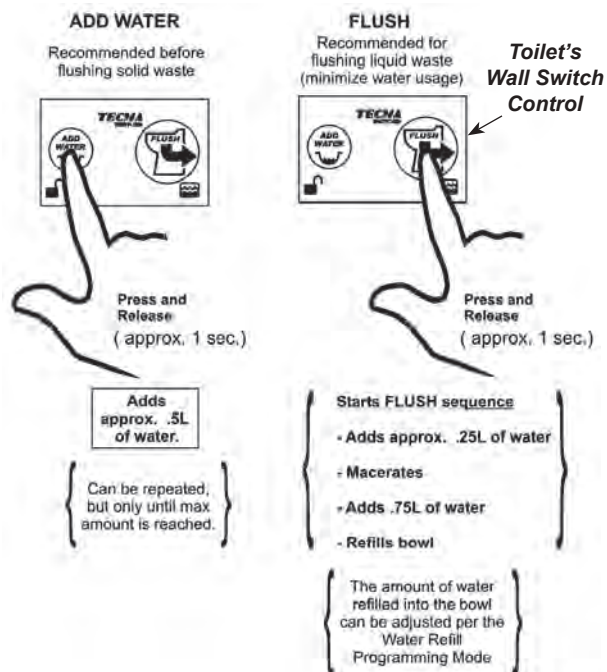


Figure J12: Toilet Operations

- 1) An ADD WATER button – Adds approximately 0.5L of water each time it is pushed momentarily. Electronics prevent overflow.



- 2) A FLUSH button – Starts an add water and macerate sequence that runs the motor and adds water twice for maximum cleansing and minimum water usage. Sequence ends with a small amount of water added to the bowl to provide an odor trap. Recommended to minimize water use and for liquid waste disposal without adding water.

**CAUTION**

If toilet is connected to any through-hull fittings, always CLOSE or TURN OFF all seacocks when boat is unattended – even if only for a minimal time.

**CAUTION**

For units using fresh water that are (at any time) connected to shoreside municipal water supply systems, Shoreside system must be DISCONNECTED if boat is left unattended – even if only for a minimal time.

**CAUTION**

Only human waste and toilet paper should be put into the toilet. Never flush FOREIGN MATERIALS (e.g. paper towels, pre-moistened wipes, condoms, feminine hygiene products, dental floss, household garbage, etc.). Damage to toilet and/or waste system may result.

**NOTICE**

It is important to use a RV/Marine tissue that disintegrates rapidly, which household tissues cannot be relied upon to do.

**B. Head With Overboard Discharge**

This option is available on the V475 models. The head toilet operations are the same as the systems described earlier. A single “wye” connector is incorporated into the waste holding tank system. See figure J13. An additional hose with a seacock and discharge pump has also been installed for overboard discharge. Refer to Figure J14. **Note:** A circuit breaker which protects the discharge pumps circuitry is located on the 12VDC cabin panel.

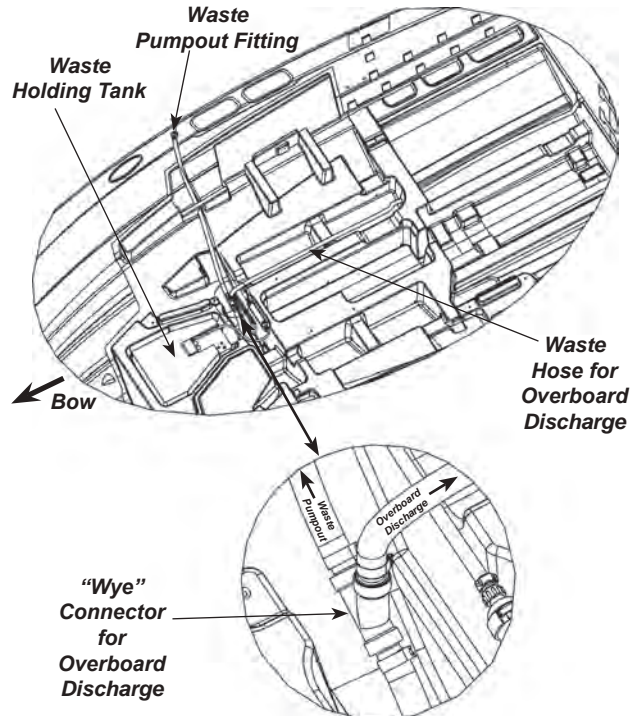


Figure J13: “Wye” Connector - Overboard Discharge

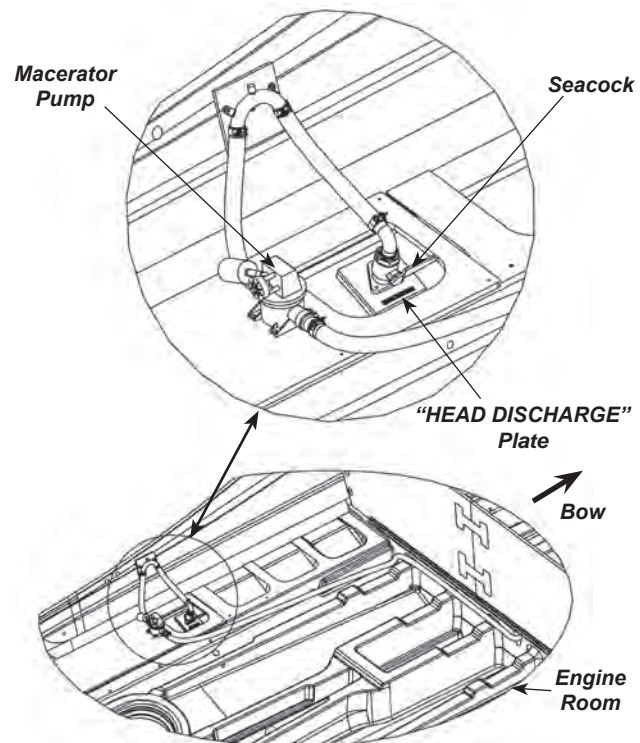


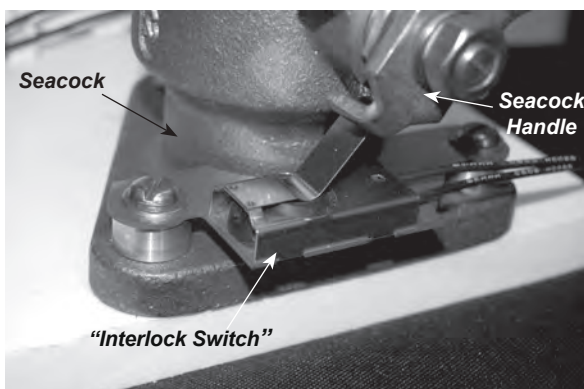
Figure J14: Seacock & Macerator Pump - Overboard Discharge

**NOTICE**

The discharge pump must be used to discharge waste overboard. However, DO NOT use the discharge pump to discharge waste at a pumping station.

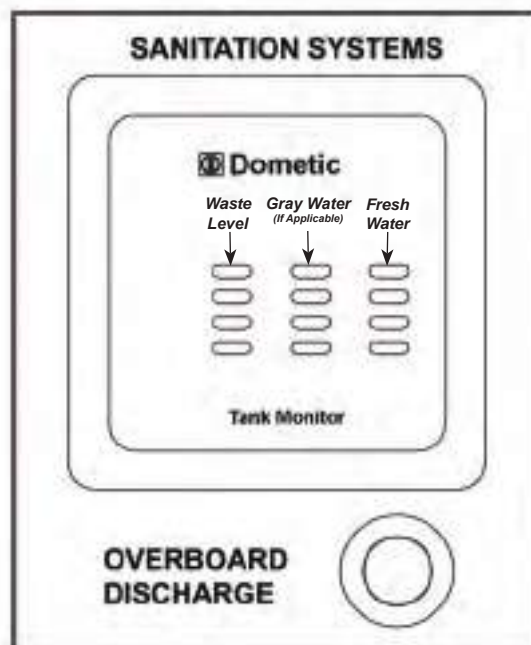
To operate the overboard discharge system:

1. The seacock (discharge valve) is located in the engine compartment labeled HEAD DISCHARGE. To open, turn the valve so that the handle is parallel to the flow of the valve. **Note:** The seacock may be fitted with a device called an “Interlock Switch” which prevents the overboard discharge switch from activating the discharge pump should the seacock be in the CLOSED position. See Figure J15. Should the pump not activate please check to see that the seacock is in the OPEN position. Additionally, the waste deck plate cover must be tightened securely for the overboard discharge system to operate properly.



**Figure J15: “Interlock Switch” Attached to Seacock**

2. Turn ON the overboard discharge switch which is located on the 12VDC cabin panel. See Figure J16. Allow the discharge pump to run until the storage tank is empty. The sound of the pump's motor load and speed will change when the tank becomes empty.

**12VDC**


**Figure J16: Overboard Discharge Switch**

3. Turn the overboard discharge switch OFF.
4. Turn the head discharge valve handle to the closed position, and secure it. This thru-hull valve (seacock) **must** be closed to prevent water from being forced back into the system.

**NOTICE**

Discharging waste overboard is illegal in most US waters today. Discharge is limited to certain coastal waters, a designated distance offshore. Check with your local boating regulations before proceeding with any discharge activities.

Some local regulations require overboard discharge systems be physically secured in a closed position during use of the boat in waters designated as “no discharge” areas. Check with local boating regulations. Refer to the manufacturer's literature for additional information.

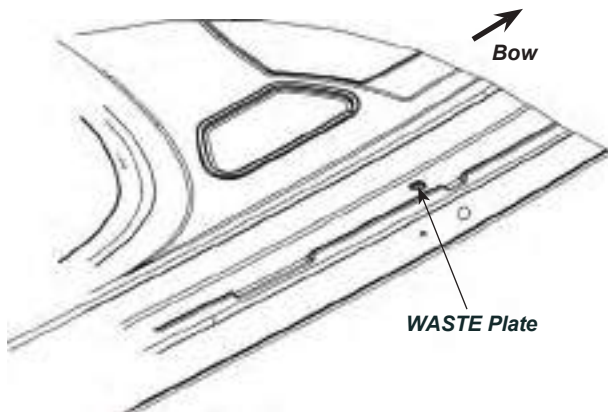
### C. Dockside Waste Pump Out

On most V Series models waste pump out capability is available. Waste can be removed from the holding tank by taking the boat to a dockside waste pumping station. Most marina fueling facilities provide such services.

The waste holding tank should be emptied when the waste level indicator reads full. The waste level indicator is located on the 12VDC cabin panel. See Figure J16. **DO NOT ALLOW THE WASTE TANK TO BECOME OVERFILLED.**

To pump out the holding tank:

1. Be sure the head has some water in the bowl.
2. Connect the dockside pump out connection to the WASTE plate located on the deck. See Figure J17.



**Figure J17: Waste Pumpout Fitting Location**

#### NOTICE

Usually the dockside pump out connection will screw into the waste deck plate or has a rubber sleeve that inserts into the plate and must be held in position during the pump out operation. If the hose is not air tight or connected properly, waste could spurt out or leak around the deck fitting and into the boat.

3. Have the pumping station operator activate the pumping equipment. The waste will be drawn from the holding tank and into the pumping station's disposal tank.

4. Remove the pump out connection from the deck plate. Add at least 5 gallons of clean water to the holding tank on most models through the waste deck fitting using a dockside water hose.
5. Repeat steps 2 & 3 above to pump out the water used in step 4 to flush the holding tank.
6. Add waste holding tank treatment chemical to the head bowl. It is available from the dockside pumping station or can be obtained from your dealer. Flush at least twice.

#### CAUTION

*Be careful when handling and storing treatment chemicals. Not only are they toxic, but they will also stain and damage surrounding surface.*

## J - 8 SYSTEM MAINTENANCE

Information supplied with water and waste system components by the equipment manufacturers is included with this manual. Refer to this literature for additional operation and service information.

Be sure the batteries in the boat are properly charged. Operating the pressure pump from a battery with a low charge will result in pump cycling. This could lead to premature pump failure.

#### CAUTION

*The decomposition of waste produces a colorless, odorless gas, methane, that is lighter than air, combustible, and extremely lethal. Always provide sufficient ventilation when effecting repairs to the waste system and allow no odor from the waste system to go unresolved.*

### A. Clean Vents and Screens

Periodically, inspect the water tank vents and thru-hull vent fittings for any dirt, wax, etc. Carefully remove any obstruction with a pipe cleaner or similar device. **Be sure not to puncture the screen.** The stainless steel vent cap is not removable.



**NOTICE**

*Failure to keep the water tank vent fittings clean will cause excessive pressure buildup within the tank during filling. This can cause water tank damage.*

Periodically remove the filter screens from the faucet discharge spouts and shower head. Remove the accumulation of sediment from the screens. If necessary, clean out the holes using a fine wire. A buildup of debris in the faucet filter screens can create enough restriction to cause the pump to cycle on and off.

Check the in-line water filter/screen for sediment and blockage. It is located between the water tank and the pressure water pump. If obstructed, remove from the water line and either clean or replace the part. The filter unit will twist apart.

Inspect and clean the shower sump every 30 days. Some water will always be in the compartment. Sediment and other debris will buildup and affect the automatic bilge switch and pump operation. Remove the pump's cover and clean the screen. The screen will become blocked and the pump will not operate properly. To clean the compartment, use baking soda and a fine wire brush to remove dirt and other debris. This will also serve to disinfect the area.

**B. Winterizing the Water System**

Winter lay-up service procedures should include a thorough draining of the water system. Disconnect all accessible fittings. Blow out all lines. Be sure the hot water heater, fresh and gray water tanks, transom shower, pumps and lines are completely dry. Leave all faucets open. Freezing water can cause severe damage to all water system components.

**NOTICE**

*Always winterize the fresh water system prior to winterization of the hull drainage (bilge pump) system.*

Draining the system as mentioned can be very tedious and an incomplete job can result in expensive repairs. The use of nontoxic antifreeze (such as R.V. antifreeze) designed for fresh water systems considerably reduces the work necessary and is a more positive means of winterizing the system. Follow the directions included with the antifreeze solution.

To winterize:

1. Turn on the water pump and drain the water tank by opening a faucet (the pump will run faster when it is empty).

**NOTICE**

*Be sure the circuit breaker for the water heater in 120 Volt AC panel is in the OFF position. The water heater will be damaged immediately by supplying electrical power to an empty water heater.*

*DO NOT run the water pump without water in the system. Pump damage will result. Be watchful and turn the pump off as soon as the tank becomes empty.*

2. Add 15 gallons of R.V. antifreeze to the water tank.

**NOTICE**

*Generally the hot water heater will require approximately five gallons of antifreeze before the hot water lines will have antifreeze running through them. The cold water faucet should be turned OFF at some point to test for antifreeze in the hot water line.*

3. Turn ON all faucets (both hot and cold) until undiluted antifreeze is seen. Make sure the transom shower, head faucet and galley faucet have antifreeze coming out.
4. Activate the shower sump pump and pour approximately 1 quart of nontoxic antifreeze down the shower drain. The shower sump will discharge some of the antifreeze overboard.



*Use only nontoxic antifreeze solutions such as R.V. antifreeze. DO NOT use ethylene glycol solutions; the type that is used in engine coolant systems. These are toxic.*

**NOTICE**

*Be sure to wipe up any antifreeze that has been spilled on the fiberglass shower surfaces.*



### C. Winterizing the Waste System

To winterize the waste holding tank, flush the tank with soap, water and a deodorizer (e.g., Lysol Liquid™). Empty the tank and pour two (2) gallons (3 gallons if equipped with overboard discharge) of R.V. antifreeze into the bowl and flush.

If the boat is equipped with overboard discharge capabilities, follow the normal procedures above. Run the discharge pump only long enough until the antifreeze solution is being pumped overboard.

For additional information, refer to the manufacturer's manuals in the owner's packet.

#### **NOTICE**

*The instructions listed in this section provide a working knowledge to winterize the water and waste systems. However, to prevent possible damage to components in your boat, Four Winns recommends having the boat winterized by your Four Winns dealer.*



## K - 1 ENGINE COMPARTMENT VENTILATION

All Four Winns V Series models are equipped with engine compartment ventilation. This system is designed to meet or exceed the requirements (in effect at the time of manufacture) of the US Coast Guard, the National Marine Manufacturers Association, and the American Boat and Yacht Council.

### A. Natural Ventilation System

This system includes air intake and exhaust components. The exhaust ducting reaches to the lower bilge area. This provides adequate air movement while underway and during bilge blower operation.

### B. Forced Air Ventilation

All Four Winns V Series models are equipped with an electric bilge blower. The bilge blower provides the ventilation required prior to starting the engines and while at idle. See Section H - Electrical Systems for blower operation instructions.

 **WARNING**

*Before starting the engine(s) or generator, operate the engine compartment bilge blower for four (4) minutes. Then check the engine compartment for fuel vapors. ALWAYS operate the bilge blower while the engines are at idle or the generator is in use. Failure to comply could cause explosion and thereby inflict serious injury or death.*

 **WARNING**

*Fumes can come from batteries while charging. A concentration of hydrogen fumes can be explosive under the right conditions. Ensure to follow the above warning.*

### C. Engine Ventilation System Maintenance

Periodic inspection and cleaning of the ventilation ducts is necessary to ensure adequate air circulation. A buildup of leaves, twigs, or other debris can severely reduce ventilation. Be sure bilge water does not accumulate to a level that would obstruct the ventilation ducts.

Blower operation can be tested by placing a hand over the vents. DO NOT rely on the sound of the blower. Be sure a substantial amount of air is being exhausted by the bilge blower. Check the bilge blower system often, preferably before each cruise.

## K - 2 CABIN & COCKPIT VENTILATION

The V475 forward stateroom is equipped with a deck hatch for ventilation. See Figure K1.



**Figure K1: Deck Hatch**

A screen and blind for the forward deck hatch is also standard. This “layered” deck hatch system allows the screen and blind to be slid to the desired position with ease. Also, storage for the screens and blinds are built into the screen/shade system. See Figure K2.



**Figure K2: Screen/Shade System**

**NOTICE**

*Be sure deck hatch is secured while underway. Damage to the hatch may result.*

The aft cabin window also opens to provide ventilation. See Figure K3.



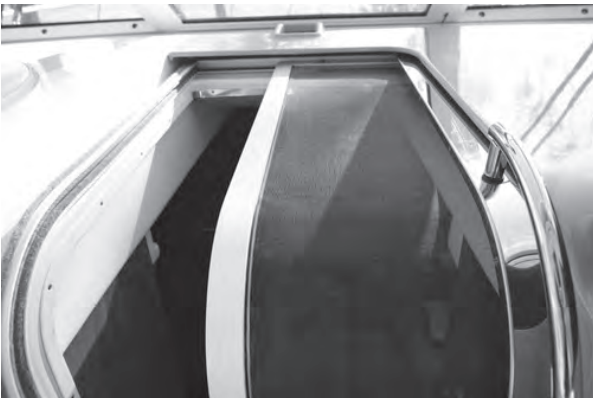
**Figure K3: Aft Cabin Portlight Window**

The cabin side windows (portlight) may be opened to provide additional ventilation. See Figure K4.



**Figure K4: Side (Portlight) Windows at Galley**

Added cabin ventilation can be obtained using the screen door at the companionway. See Figure K5.



**Figure K5: Companionway Screen Door**

The center windshield may be slid open to allow ventilation of the cockpit as desired. See Figure K6.

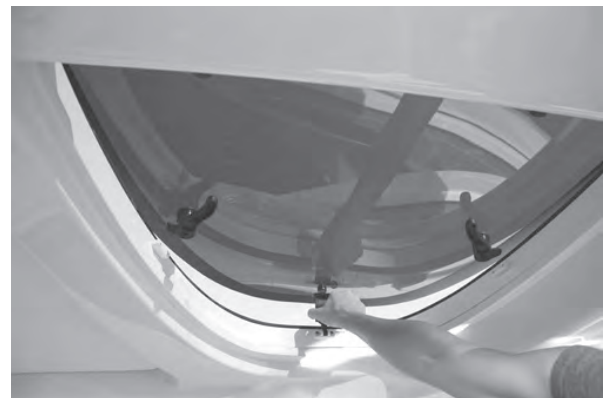


**Figure K6: Center Windshield**

The hardtop features three (3) built-in skylights. The port and starboard skylights may be open to also assist in ventilating the cockpit area. The center is fixed. See Figures K7 & K8.



**Figure K7: Hardtop w/Skylights**



**Figure K8: Opening Skylight - Hardtop**

**⚠ WARNING**

*Failure to properly ventilate the boat while the engines or generator are operating may permit carbon monoxide to accumulate inside of the cabin. Refer to Section E-2 - Engine Exhaust and Section B-2 - Carbon Monoxide for additional information.*

## K - 3 HULL DRAINAGE SYSTEMS

### A. Transom Drain

A transom drain with plug is provided in the engine compartment to allow water drainage. When boat is out of the water, the boat and cradle should be positioned so any bilge water accumulation during dry storage will flow towards the transom.

**⚠ CAUTION**

*Be sure the drain plug is securely in place prior to launching the boat. Upon shipment of the boat, the drain plug is usually taped to the steering wheel.*

### B. Bilge Pumps

Forward and aft bilge pumps are provided in the bottom of the hull to remove miscellaneous water accumulations that might occur during normal boating or weather conditions. See the V475 locator drawing at the back of this manual. The aft bilge pumps is controlled by the BILGE PUMP switch located on the helm switch panel. Refer to Section H for further information regarding bilge pumps.

The bilge pumps are equipped with an automatic switch to control pump operation. As the water level rises, the automatic float switch will activate the pump. Separate circuit breakers are located at the helm circuit breaker panel and the aft circuit breaker panel for the aft bilge pumps. A circuit breaker for the forward bilge pump is located on the 12VDC panel.

**NOTICE**

*While at rest, any bilge water accumulation may flow forward. DO NOT allow bilge water to accumulate. Damage to the engine or other components may result. Periodically operate the bilge pump to remove bilge water accumulation.*

When leaving the boat unattended for long periods of time or during excessive rain storms, it is a good idea to check on the boat for excessive water accumulation. Be sure the bilge pumps and automatic float switches are operating properly. The operating time of the bilge pumps will be limited to the battery capacity.

Periodically, clean the bilge pump strainers. DO NOT allow dirt and debris to clog the bilge pump intakes. Check operation of the bilge pump float switch often to ensure movement of the switch is not restricted by debris or other foreign matter.

Wipe up any oil accumulation in the bilge prior to activation of the bilge pumps. Pumping oil overboard will pollute the water, and is subject to fine.

After winterization of the fresh water systems, be sure the bilge area, bilge pumps and associated hoses are thoroughly dry. Damage to the hull, bilge pumps and other equipment could occur if water is allowed to freeze in the bilge. Refer to the manufacturers literature included in the owner's packet for additional information.

### C. Sump

A forward and aft sump are installed in the floor, just forward and aft of the fresh water tank respectively. See the V475 locator drawing at the back of this manual. These sumps collect gray water from the various sinks & showers on the boat. Each sump includes a sump pump which is equipped with an automatic float switch. The gray water is then pumped overboard through thru-hull fittings or into the gray water holding tank (if installed). A pumpout fitting labeled WASTE but designated for gray water is provided on the deck for removal at a pumpout station. Refer to Section J- additional information on the gray water system.

### D. Bilge Compartment Drainage

Certain bulkhead areas of Four Winns® boats are sealed in accordance with US Coast Guard regulations effective at the date of manufacture. Drainage is provided and water can be removed with the bilge pump.

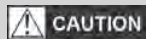


### **E. Cockpit Drainage**

The V475 models incorporates a fiberglass self-draining cockpit. This feature minimizes water entry to the bilge or engine compartment areas by providing means for water to be drained overboard.

Periodically open all engine hatches and clean the aft bilge compartment. Be sure the drains, tubes and fittings are clean and free of leaves, dirt, or other debris.

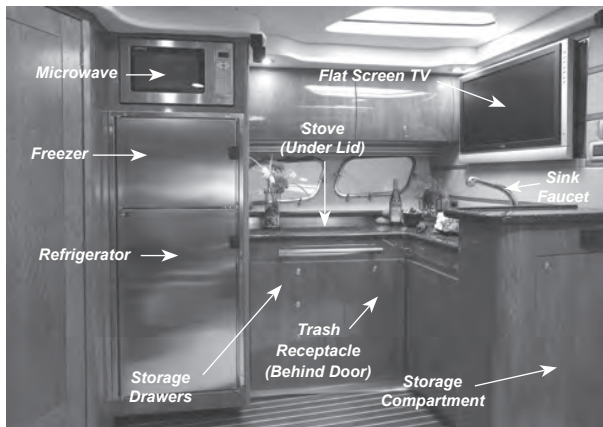


**L - 1 GALLEY EQUIPMENT**


*Care must be exercised while around stoves and other appliances. Keep children away from burners.*

**A. Electric Stove**

An electric stove with dual flush-mounted burners is standard. See Figure L1 for stove and other appliance locations. A circuit breaker (RANGE) is provided in the 240V AC cabin electrical panel. When the stove is not in use, a cover/lid may be closed to increase countertop space. Be sure the stove is OFF and cool before closing the stove's lid. There is a contact safety switch that shuts off the stove should it be closed while the burners are still on. See Figure L2. Refer to the Section H of this manual and the manufacturer's literature included in the owner's packet for operation and safety procedures.



**Figure L1: Galley**



**Figure L2: Stove Lid - Open**

**B. Galley Sink**

The galley sink is covered to create more countertop space when not in use. The cover may be stored inside the inboard portion of the galley assembly. See Figure L3. The faucet is also a sprayer and may be pulled out of its holder to assist in the rinsing of dishes.



**Figure L3: Sink Lid Storage**

**C. Microwave Oven**

A microwave oven is standard on the V475 models. The circuit breaker labeled MICROWAVE on the 240V AC cabin electrical panel must be activated and the boat must be connected to dockside power or utilize the generator in order to operate the microwave. Refer to the manufacturer's literature provided in the owner's packet.



*Do not restrict air flow while microwave is in use, or damage to microwave oven or cabinet may result.*

**D. Galley Refrigerator/Freezer**

A galley refrigerator/freezer is standard equipment. The refrigerator is designed to operate efficiently on AC Shore Power (120 volt or 230VAC - international) or battery power (12 volt). The refrigerator will automatically transfer to 12 volt operation when dockside power is not available and the 12 volt GALLEY REFRIGERATOR circuit breaker is ON.

Most refrigerator models have a thermostat that will maintain the temperature desired. According to the refrigerator manufacturer's operations manual, select the temperature setting by turning the thermostat dial to the various numbered positions. The refrigerator

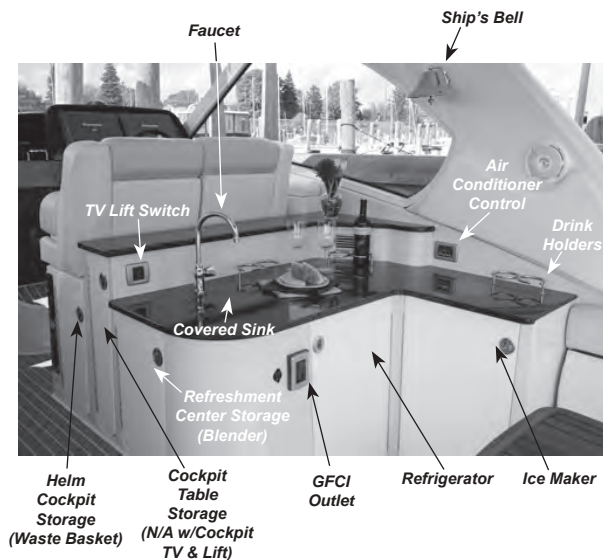
may be turned off by turning the thermostat to the "OFF" position. See the manufacturer's literature included in the owner's packet for specific information on the model used in your V Series.

Care should be exercised while operating the refrigerator on the 12 volt system. The refrigerator requires a substantial amount of current. Excessive current draw can severely drain a battery through extended use.

On certain models a magnetic strip is used inside the seal of the refrigerators. The magnetic strip allows the seal to draw tight to the inside of the refrigerator when the door is closed. Also, make sure retaining latch is in place to secure refrigerator door while underway.

## L - 2 COCKPIT REFRESHMENT CENTER

The V475 comes with a refreshment center built-in to the cockpit. The refreshment center comes with a solid surface countertop, blender, trash receptacle, drink holder, covered sink with faucet, icemaker and refrigerator. See Figure L4.



**Figure L4: Cockpit Refreshment Center**

The cockpit refrigerator operates automatically on 120 volt AC or 12V DC power supply. When both power sources are supplied to the refrigerator, it defaults to AC. When the refrigerator is disconnected from shore power (when AC power is no longer available) the refrigerator switches to DC operation.

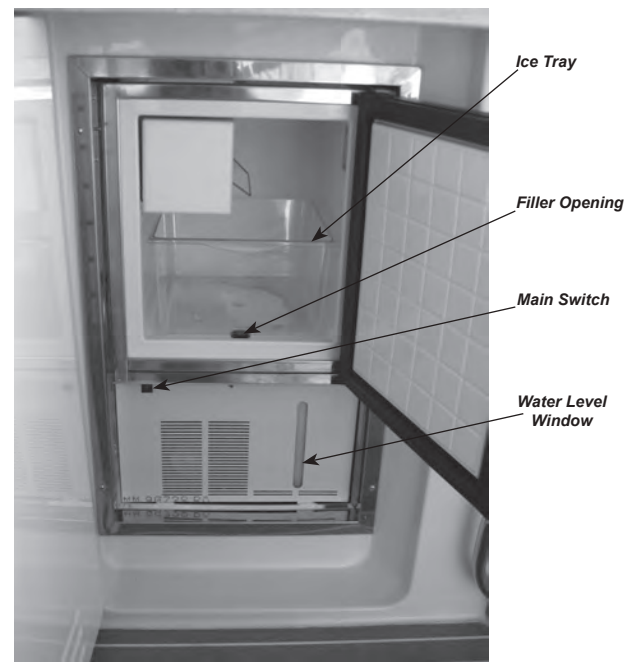
The cockpit refrigerator runs continuously and does not utilize water. Unlike the icemaker, no winterization

is required. Please follow the manufacturer's instructions regarding the use, care and maintenance of the refrigerator. These instructions are found in the owner's packet.

The icemaker operates on 120 volt (230 volt on 50 Hertz models) AC power and will only function when plugged into dockside power or when the generator is running. The icemaker circuitry is protected by the ICEMAKER circuit breaker on the 240V AC cabin electrical panel. Refer to Section H - Electrical Systems for more information.

To operate the ice maker:

- 1) Open the door and remove the ice tray.
- 2) Pour bottled water into the tank through the filler opening (minimum 1 liter / maximum 8 liters) See Figure L5. The water level may be checked through the water level window.



**Figure L5: Ice Maker**

### NOTICE

The icemaker is not connected to the boat's fresh water system and will not operate without water in the tank.

- 3) Turn the main switch ON. The first ice cubes should take approximately 1 hour to be made.

Consult the manufacturer's information in the owner's packet for specific operation instructions, maintenance and winterization instructions regarding your particular model.

### L - 3 COCKPIT STORAGE

Storage compartments are provided throughout the cockpit area. See Figures L4, and L6 - L9 for some examples. Storage space is designed to be easily accessible.



**Figure L6: Starboard Stern Seat Storage**



**Figure L7: Aft Stern Seat Storage**



**Figure L8: Port Dash Map Storage Compartment**



**Figure L9: Transom Storage Locker**

### L - 4 ENTERTAINMENT

#### A. Stereo System - Helm & Transom

At the helm is installed an AM/FM/CD stereo with remote and an iPod/MP3 player port. An amplifier is a standard component of this stereo system. A stereo remote with display feature at the transom is also included. See Figures L10 - L12. Speakers are installed throughout the exterior cockpit areas to provide excellent sound quality. In addition, the speakers can be faded in or out depending on the effect desired. For stereo operation, please refer to the manufacturer's manual included in the owner's information packet. A "V475 Entertainment Quick Reference Guide" is included at the end of this section.



**Figure L10: Helm Stereo**





**Figure L11: Cockpit Speaker**



**Figure L13: Bose Receiver/DVD Player**



**Figure L12: Transom Stereo Remote**



**Figure L14: Bose Speaker  
(Typical)**

Also, the V475 can be equipped with an “aftermarket” satellite radio receiver. If installed, the satellite radio remote control operates the sound below deck when the Bose Lifestyle® 35 System is set to CBL/SAT source. The satellite radio in the cockpit may be controlled through the stereo at the helm or transom remote provided they are “satellite ready”. This allows two separate stations to play above and below deck or boaters can choose the same station for “party mode”.

### **B. Bose Lifestyle® 35 System**

The Bose Lifestyle® 35 System supplies the AM, FM, CD and the DVD for the entire cabin. The Bose speakers provide an all-around sound experience. See Figures L13 & L14.

**Please note:** Boaters may enjoy one radio station choice at a time in the three zones below deck, or if preferred, each separate zone may choose a separate choice such as AM, FM, CD or local TV. For Bose Lifestyle® 35 System operation, please refer to the manufacturer’s manual included in the owner’s information packet. Also refer to “V475 Entertainment Quick Reference Guide” included at the end of this section.

### C. Flat Screen Televisions with Remotes

#### NOTICE

*These flat screen televisions are wired into the Bose stereo speaker system as well as the Bose DVD player. Please read the manufacturer's information on the TV and DVD player in combination with the "V475 Entertainment Quick Reference Guide" for operation instructions.*

- 1. Cabin/Salon** - A flat screen TV with remote is mounted in the galley for viewing in the main cabin/salon area. An electric hinging mount allows the TV to swivel in order to obtain the best viewing possible. The switch to operate the electric mount is located in the galley, near the TV itself. See Figure L15.



**Figure L15: Flat Screen Television - Salon**

- 2. Private Stateroom** - For space savings and convenience the flat screen TV with remote is mounted on a slider drawer. Pull the drawer out for TV viewing and close the drawer to hide and protect the TV when not in use. See Figure L16.



**Figure L16: Private Stateroom TV**

- 3. Mid Cabin Stateroom** - A flat screen TV with remote is mounted on the bulkhead to provide comfortable viewing for TV watchers. See Figure L17.



**Figure L17: Mid Cabin TV**

#### NOTICE

##### SOUND AND DVD OPERATION

*The V475 is equipped with a channel modulator to distribute the various video sources throughout the boat. In order for the channel modulator to function properly, TVs must be set to receive a cable signal. The following channels are programmed at the Four Winns factory; they may be altered by your Dealer if necessary.*

**Bose Receiver/DVD Player: Channel 65**

**Satellite\* Receiver One: Channel 68**

**Satellite\* Receiver Two: Channel 71**

*\*Satellite Television System is optional.*

**Note:** A dockside phone/cable TV inlet is installed on the V475. This dockside inlet connection for telephone/cable TV is located on the starboard transom. See Figure L18.



**Figure L18: Phone/Cable TV Dockside Inlet Location**

#### D. Cockpit TV Options

##### NOTICE

*These optional flat screen televisions are wired into the Bose Lifestyle® 35 System. Please read the manufacturer's information on the TV and DVD player in combination with the "V475 Entertainment Quick Reference Guide" for operation instructions.*

#### 1. Port Dash TV and DVD Player

An optional flat screen TV with remote which includes a DVD player may be installed in the port dash's map storage compartment. See Figure L19. If equipped, this option provides television viewing from the port lounge area. This TV may also view the DVD playing in the Bose DVD player if so desired. See your Four Winns dealer for details and availability.



**Figure L19: Port Dash TV & DVD Player**

#### 2. Cockpit TV w/Electronic Lift

An optional flat screen TV with remote may be installed at the refreshment center. A DVD player is included and is installed in the port dash. This option also includes an electric lift which permits the TV to be raised out of or retracted into the cockpit table storage compartment. A switch at the refreshment center operates the lift. See Figure L20. **Note:** If installed, the storage for the cockpit table is no longer available. This option provides television viewing from the stern seating and swim platform areas. This TV may also view the DVD playing in the Bose Lifestyle® 35 DVD player if so desired or the DVD playing from the port dash. See your Four Winns dealer for details and availability.



**Figure L20: Cockpit TV w/Electric Lift**

#### E. Satellite TV System Option

The satellite TV option includes two satellite receivers. They are located beneath the main control panel in the salon and can be powered by pressing the POWER button on the face of each receiver or by using the SATELLITE REMOTE CONTROL. See Figure L21.



**Figure L21: Satellite Receivers**



Please read the manufacturer's information regarding the satellite TV system along with the "V475 Entertainment Quick Reference Guide" for operation instructions.

## L - 5 CENTRAL VACUUM

Central vacuum is standard equipment which makes cleaning your V475 convenient. The vacuum is located under the aft salon couch cushion and the inlet to attach the hose is located under the companionway/cabin steps. See Figure L22. The vacuum circuit breaker switch is located on the 240V AC main cabin panel. Please read the manufacturer's literature included in the owner's packet regarding operating and maintaining the vacuum.



**Figure L22: Central Vacuum**

## L - 6 WASHER/DRYER OPTION

An optional combination washer/dryer is available. With this option you now can do laundry onboard. The gray water is pumped overboard or into the gray water tank if the gray water option is installed. See Figure L23. The washer/dryer circuit breaker switch is located on the 240V AC main cabin panel. Please read the manufacturer's literature included in the owner's packet regarding washer/dryer operation and maintenance.



**Figure L23: Combination Washer Dryer**

## L - 7 AIR CONDITIONING

Air conditioner/heaters provide either cooling or heating and are standard features. The units operate on 240 volt (230 volt on 50 hertz on export models) AC power. The output of the air conditioners may be found on our website at [www.fourwinns.com](http://www.fourwinns.com). Be sure the shore power cord is connected or the generator is running whenever the air conditioners are used.

The air conditioning breakers must be turned on to activate the air conditioning units along with the air conditioner seawater pump. These breakers are located at the 240V AC cabin panel. Depending upon humidity, the air conditioners will condense 5 to 15 gallons of water a day and this water drains into the respective sumps.

The air conditioner units are located under the galley, under the companionway/cabin steps and under the helm seat. Please refer to the locator drawing at the back of this manual.

### NOTICE

Four Winns continually strives to improve its products. The locations and quantities of air conditioners are subject to change without notice depending on the model. *The most current and accurate information available at the time of publication is included in this manual. Some variation in material, equipment, description, location, and details can result. Please refer to our website for further updated information and possible revisions to this manual.*

Air conditioner vents are located throughout the cabin and cockpit to provide good air circulation. The vents



are adjustable to change air flow direction and can be closed.

The seawater inlet valve (seacock) is identified with a plate inscribed with the words "Air Conditioner Seawater". The seacock must be opened prior to running the air conditioners. Access to the seacock is gained through the engine room. See Figure L24.

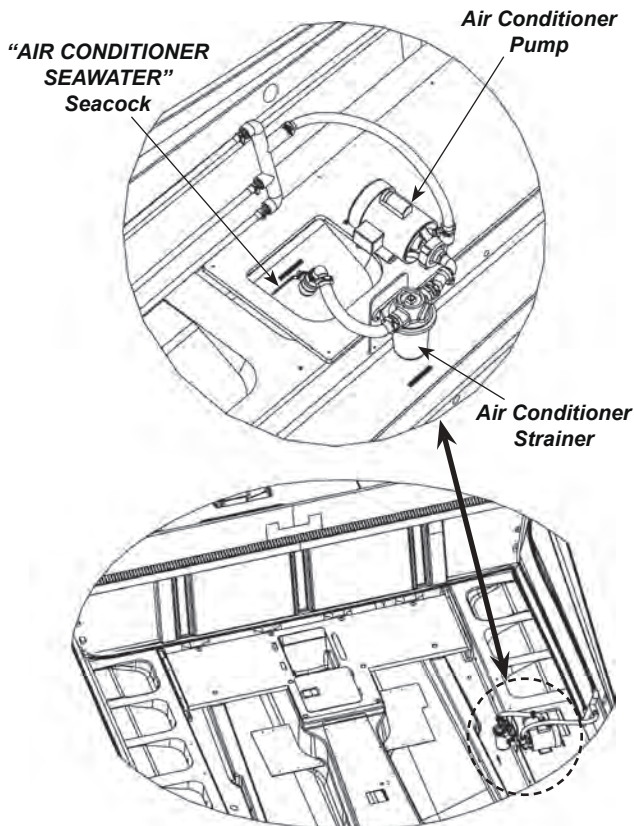
**NOTICE**

*In order to use the air conditioner, you must first open the seawater inlet valve - seacock (handle parallel to the flow of valve). When not using the air conditioner be sure to close the valve/seacock.*

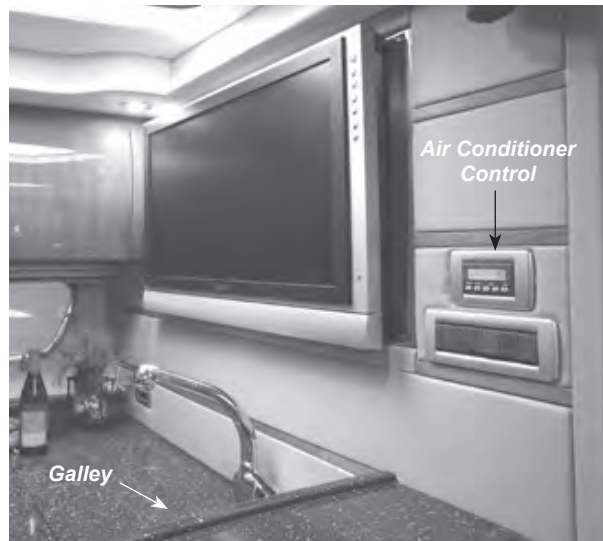
**NOTICE**

*Most air conditioners utilize surface water as the cooling medium. Prior to using the air conditioning, the boat must be in the water and the seacock to the air conditioning water intake must be in the open position. The air conditioning seacock for water intake is located in the engine room. Operating air conditioners without proper cooling water will cause damage to the air conditioning system.*

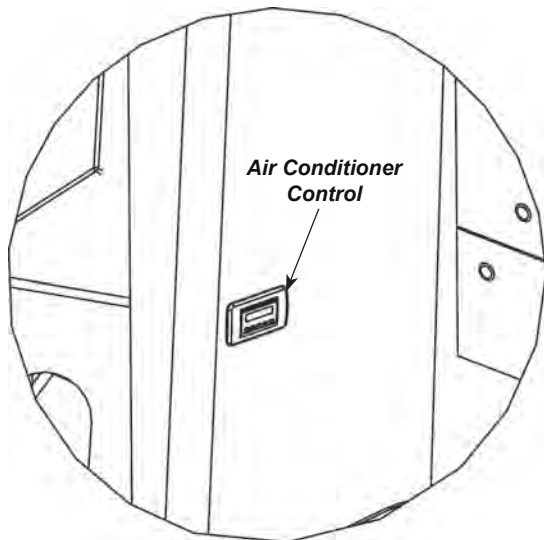
Refer to the Figures L25 - L27 for the location of the air conditioning control panels. Please read the manufacturer's information on the air conditioner contained in the owner's packet for operation instructions.



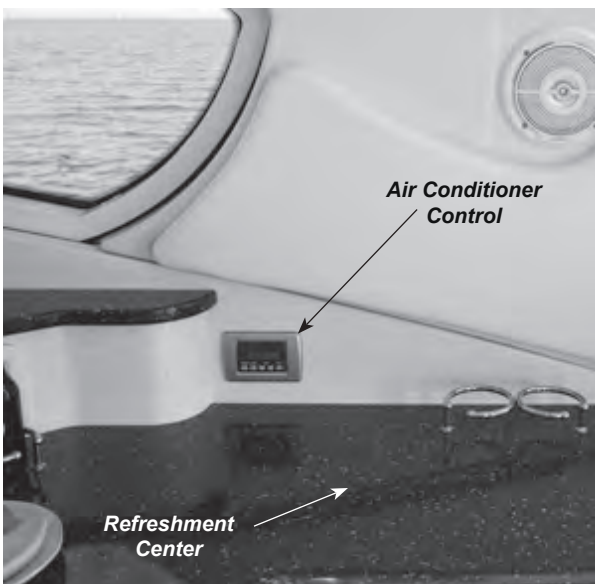
**Figure L24: Air Conditioner Seacock Location**



**Figure L25: Air Conditioner Main Cabin / Aft Cabin Control Panel Location**



**Figure L26: Air Conditioner Master Stateroom Control Panel Location**



**Figure L27: Air Conditioner Cockpit Control Panel Location**

Air conditioners utilized in Four Winns® V-series models are equipped with reverse cycle heat. Thus, some heat effect can be derived from the unit. It must be noted that the amount of heat that can be obtained is limited by the temperature of the raw cooling water pumped through the system. When the water temperature drops to 40 degrees Fahrenheit, the output is about 50% of the maximum. At 36 degrees Fahrenheit, the output is very low.

#### **NOTICE**

*During cold conditions, an alternate or supplemental heating system should be used.*

Clean the sea water strainer often. Also, clean the return air filter screens, located behind the louvered doors and grills, at least once a month.

To winterize, refer to the manufacturer's literature included in the owner's packet.

#### **L - 8 CARBON MONOXIDE DETECTORS**

The CO detectors are very important pieces of safety equipment. These monitors are sensitive and must be cared for properly. Four Winns has included three CO detectors as a standard feature in the V475. Read the manufacturer's manual included in your owner's packet regarding CO monitor operation, testing and maintenance procedures. Also be sure to read Section B-2 - Carbon Monoxide and E-2 - Engine Exhaust.

#### **WARNING**

*Unit should be cleaned weekly without the use of solvents. Cleaning solvents and oils can cause the alarm to stop functioning. Test the alarm if it has come in contact with any cleaning solvents or any condition that may cause the alarm to stop working.*



## V475 ENTERTAINMENT QUICK REFERENCE GUIDE

**Congratulations on the ownership of your new Four Winns V475.** This boat is equipped with three to five televisions, one or two DVD players, two iPod/MP3 player ports, a Sony® AM/FM/CD player, a Bose® surround sound system, and if you chose it as an option, satellite TV. This means you could have as many as 13 remote controls. But before you think there isn't even a remote chance that you can figure out how everything works, relax. We've put together this handy "quick start" card to help you understand how things are configured, and more importantly, how you can make the entertainment units on this boat work for you. Complete operations manuals for each component are also included in your Owners Manual Packet.



### POWER FIRST:

Power switches for all electronics on your boat are located in the control panel in the salon. The entertainment components require 110 voltage, so be sure that the breaker switches for OUTLETS (salon, galley, stateroom, aft cabin, and cockpit) are in the ON position. Additionally, there is a breaker switch for the cockpit tv, which should also be in the ON position for use.

**Please note: Outlets can be operated on either shore power or when the generator is running.**

**SPECIAL NOTE\*** Each television requires an initial set-up when first plugged in and powered. This is done at the Four Winns factory, and may be repeated by your Dealer for your geographic location. The initial user selects the source of TV channels (antenna, cable, and/or satellite) and the TV then automatically programs itself to the selected source. You should not have to repeat this step unless you have moved the boat to a different cable market. In the event that your TVs have been disconnected, follow the on-screen instructions to allow for auto-programming. You will need to perform this for each TV on the boat.

### TELEVISION OPERATION

Standard equipment in the V475 includes flatscreen TVs in the salon, the master stateroom, and the mid-cabin. Optional equipment includes one or two flatscreen TVs in the cockpit. The cockpit TV in the port dash includes a DVD player with remote which plays on both cockpit TVs, if desired. The Bose Lifestyle 35 System (see reverse of card), also standard, includes a DVD player, which feeds to all of the boat's TVs.

1 In order for your TV to recognize all available sources of input, you need to turn everything on:

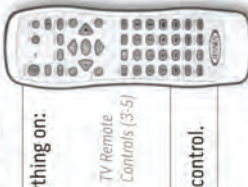
- A) Turn on both satellite receivers (if you have chosen this option).
- B) Turn on the Bose Lifestyle 35 System and insert a DVD into the DVD slot.
- C) If you are in a marina or slip with shore/dockside cable, connect the cable to the TV/Cable port located on the transom.

2 Turn ON the TVs by pressing either the **⏻** on the TV or **POWER** on the TV remote control.

3 Press the **MENU** button on the remote control.

4 Using the arrow buttons, select **CABLE** or **ANTENNA**. If you are unsure of what type of cable system you have, you can select the **AUTO PROGRAM** feature and the unit will automatically detect the proper cable source. Auto Programming takes a few minutes; please be patient.

5 When your TVs recognize their sources, you will be able to select channels with the channel up/down buttons.



### Satellite Receivers ONE and TWO:

1. If you have elected the Satellite TV option, your V475 will include two satellite receivers. They are located beneath the main control panel in the salon and can be powered by pressing the **POWER** button on the face of each receiver or by using the **SATELLITE REMOTE CONTROL**.

2. Set your TV to one of the satellite channels (Channel 68 or Channel 71), and then select the desired **DIRECT TV** channel by using the **SATELLITE REMOTE CONTROL**.

3. **SATELLITE TV REMOTE CONTROLS** operate on RF, so they can control the salon receivers from any location on the boat.



### COMPONENT/CONTROL LOCATIONS



- Cockpit television
- Electrical panel
- Sony® control components
- Interior television



Satellite TV Remote Controls (2)



**SOUND AND DVD OPERATION**

**Channel Modulator**

The V475 is equipped with a channel modulator to distribute the various video sources throughout the boat. Please note: In order for the channel modulator to function properly, TVs must be set to receive a cable signal. The following channels are programmed at the Four Winns factory; they may be altered by your Dealer if necessary.



**Bose Lifestyle 35 System**

The Bose Lifestyle System supplies the AM, FM, CD, and the DVD for the entire cabin.

*Please note: Boaters may enjoy one radio station choice at a time in the three zones below deck, or if preferred, each separate zone may choose a separate choice such as FM/AM radio, CD, or local TV.*

There are three RF Bose REMOTE CONTROLS used to select entertainment channels and to control volume. The salon REMOTE CONTROL is not labeled. The mid-cabin remote is labeled with a B. The stateroom remote is labeled with a C. The gray buttons at the top of the remote controls allow you to choose the source: CD/DVD, FM/AM Radio, AUX (iPod or MP3 player input), TV (Antenna), and CABLE/SATELLITE TV.

**Sony® AM/FM/CD Stereo**

At the helm, there is a Sony® AM/FM/CD player with remote and iPod/iPod/MP3 player port and charger. The Sony® has its own hand-held remote and there is a stationary remote control at the swim platform. Source selection and volume can be controlled at either area.

Sony® swim platform control



Sony® remote control



Bose Receiver/DVD Player

Auxiliary Components, such as digital cameras and video game systems, can be directly connected to the salon, mid-cabin, and cockpit TVs through ports on the left side of the screens. Input jacks are not accessible on the Stateroom TV.

Satellite Receiver One and Two

The Four Winns V475 can be equipped with an "aftermarket" satellite radio if desired. The satellite remote control operates the sound below deck when the Bose Lifestyle System is set to CBL/SAT source. The satellite in the cockpit is controlled through the Sony® Stereo at the helm or the Sony® transom remote. This allows two separate stations to play above and below deck or boaters can choose the same station for "party mode".



SIRIUS Entertainment Remote Control shown (Available "Aftermarket" only)



**M - 1 RAILS & DECK HARDWARE**

Hand and bow rails have been installed to provide security for passengers using the walk-around deck and while outside the cockpit area (i.e. swim platform and bow areas). Limiting passenger movement while underway is recommended. All those on board should be safely seated whenever possible. Additional care must be taken when in rough seas or foul weather. Access to the foredeck should be through the foredeck hatch when running in adverse conditions.

 **WARNING**

*Four Winns does not recommend occupying the foredeck during bad weather or on rough seas. DO NOT use walk-around deck instead use deck hatch and only if absolutely necessary during any bad weather or on rough sea conditions.*

The rail system and hardware fittings have been selected and installed to perform specific functions. Fenders or mooring lines should not be secured to the rails or stanchions. Be certain that a clear lead exists when running dock lines or an anchor line. A line inadvertently threaded around a stanchion or over the rail could cause damage.

The majority of the hardware installed is made of stainless steel. See Figure M1. Regardless of the type of hardware used, periodic maintenance is necessary.

*Intermediate Lifeline*



**Figure M1: Stainless Steel Fittings**

Cleaning the hardware with a nonabrasive cleaner will help keep the original shine and beauty. Stainless steel hardware, while quite durable, can become

superficially rusted. This can be controlled by cleaning the fittings and applying a coat of wax. Any future rusting can be removed by polishing and rewaxing.

**NOTICE**

*All fittings must be periodically inspected for loosening, wear, and damage. Problems should be corrected immediately!*

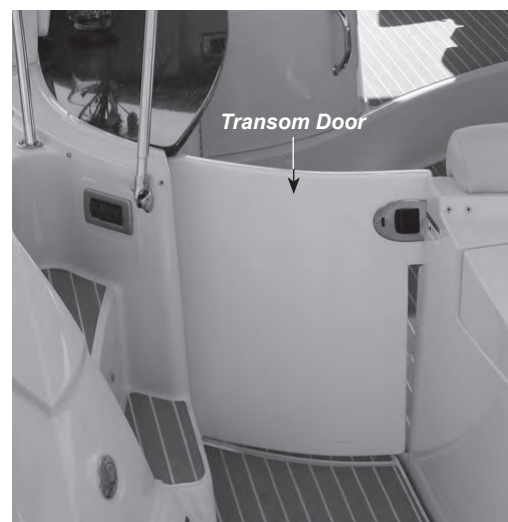
The cleats that have been installed are specifically designed and are intended to be used as mooring cleats. Their purpose is for securing the vessel to a dock, pier, mooring, or anchor.

 **WARNING**

*Four Winns® boats are not equipped with any hardware designed for towing purposes. The mooring cleats that are installed on the boat are not to be used for towing another vessel or having the boat towed. Refer to Section A - Operation for additional precautions regarding grounding and towing.*

**M - 2 TRANSOM DOOR**

A transom door is provided and allows access from the cockpit to the swim platform. A door latch is used to secure the transom door closed while underway. The door, while the boat is at rest, may be latched in the opened position for convenience. To prevent a possible man overboard situation, make sure the transom door is secure before becoming underway. See Figure M2.



**Figure M2: Transom Door**

**⚠ DANGER**

To prevent personal injury, swim platform must not be occupied and transom door must be closed while engines are running.

**⚠ WARNING**

Prevent falls overboard. Close, latch, and stay inside gate while underway.

**⚠ CAUTION**

To prevent personal injury, DO NOT sit on or lean against the transom door.

**NOTICE**

To prevent damage to the companionway track, the companionway door must be moved slowly and carefully during use.

A lock is provided on the companionway door to secure the cabin.

**NOTICE**

Always secure companionway door before operating the boat. Rough water or significant wake could cause the companionway door to slam shut and break. Acrylic plastic is impact resistant but in extreme cases it can crack and/or the track could become damaged if not secured.

### M - 3 COMPANIONWAY DOOR

The V475 models have a one-piece sliding companionway door on a track. The companionway door includes a built-in screen for added ventilation and comfort. See Figures M3 & M4. A hinged stop at threshold secures the door in the open position.



**Figure M3: Companionway Door**



**Figure M4: Companionway Door Screen**

To clean acrylic plastic (plexiglass):

- 1) Rinse with plenty of water to wash off as much dirt as possible.
- 2) Using your bare hand, along with plenty of water, feel and remove any dried on dirt or mud.
- 3) Wash using a soft, grit free cloth or sponge and mild, nonabrasive soap or detergent.
- 4) Blot dry using a clean, damp chamois.

**NOTICE**

**Never use a dry cloth, duster, glass cleaning solutions or citrus cleaner on acrylic plastic.**

See Section Q - 8 for additional information on the care of acrylic plastic.

### M - 4 WINDOWS

#### A. Windshield

The windshield consist of tempered safety glass. See Figure M5. Port and starboard windshield wipers and washers are also standard equipment. The center windshield may be slid open to allow ventilation of the cockpit.



**Figure M5: Windshield**

The windshield can be cleaned with automotive glass cleaners or dishwashing soap and water. Ensure that a clean cloth is used to prevent scratching the glass.

**NOTICE**

*Read the label before using any product. DO NOT use abrasive cleaners.*

An optional windshield shade may be purchased to provide additional privacy for the cockpit. See your Four Winns dealer for details.

**B. Cabin/Cockpit Windows**

Plexiglass (acrylic plastic) is used for port holes, cabin windows, skylights, and companionway door assemblies. Plexiglass will scratch easily and must be handled with care.

To clean, follow the instructions located in Sections M-3 and Q-8. DO NOT use paper towels. They will scratch the plexiglass.

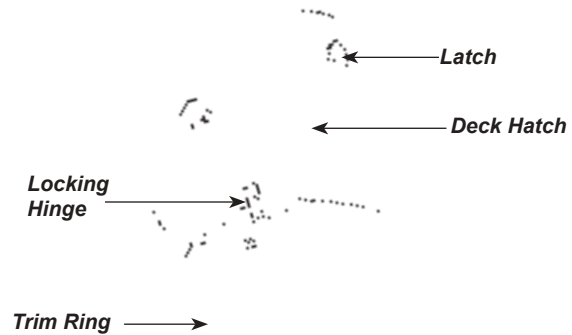
Plexiglass or plastic polish may also be used. Read the label first before using any cleaning product.

**NOTICE**

*DO NOT use harsh chemicals or strong cleaning solutions on plexiglass. The surface can be etched, scratched, disfigured, or clouded. See Section Q - 8 Acrylic Plastic - (Plexiglass).*

**M - 5 FOREDECK HATCH**

The foredeck hatch consist of a translucent plexiglass. The hatch is supported by one locking hinge and can be secured in a partially open position for ventilation. See Figure M6. Follow the cleaning directions for plexiglass described in Sections M - 3 and Q - 8 of this manual.



**Figure M6: Forward Deck Hatch**

**WARNING**

*Four Winns does not recommend occupying the foredeck during bad weather or on rough seas. DO NOT use walk-around deck instead use deck hatch and only if absolutely necessary during any bad weather or on rough sea conditions.*

**CAUTION**

*Make sure deck hatch is closed or be aware of its location when moving around the foredeck to prevent possible injury.*

A screen and blind for the forward deck hatch is a standard feature. This “layered” deck hatch system allows the screen and blind to be slid to the desired position with ease. Also, storage for the screen and blind is built into the screen/shade system. See Figure M7.





**Figure M7: Screen/Shade System**

**NOTICE**

*Be sure deck hatch is secured while underway. Damage to the hatch may result.*

**M - 6 EXTENDED SWIM PLATFORM**

Four Winns provides an aft, extended swim platform on the V475 models. For better footing, a skid-resistant surface is provided. The port and starboard ladders are angled with wide step pads and deep reaching for ease of use and comfort. When not in use the ladders can be folded and concealed in respective ladder storage compartments of the swim platform. A grab handle is located in the ladder lid to assist while boarding. Additionally, on both the port and starboard side are built-in storage tubs. See Figures M8 - M10.



**Figure M8: Extended Swim Platform**



**Figure M9: Starboard Boarding Ladder Shown**  
(Typical Port & Starboard)

**WARNING**

*To prevent personal injury, DO NOT use the boarding ladder or swim platform while the engines are operating or the boat is in motion. Engines must be off when using the swim platform or boarding ladder. See Preface for specific label information.*

**WARNING**

*Keep hands and fingers away from ladder supports and hinges to prevent injury.*

**NOTICE**

*Always secure the ladder before boating. Damage to the ladder may otherwise result.*



**Figure M10: Port Storage Tub Shown**

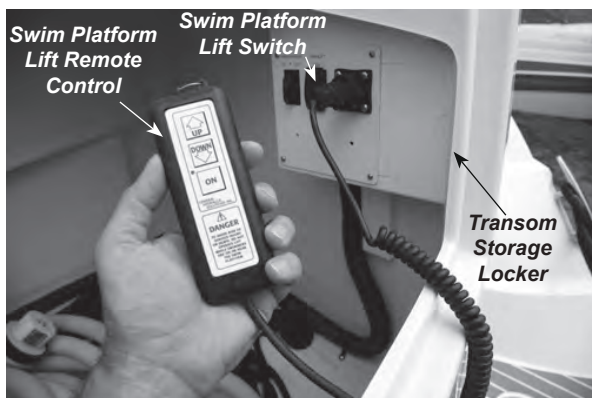


## M - 7 SWIM PLATFORM LIFT OPTION

If the optional swim platform lift is installed, the extended swim platform may be lowered into the water using hydraulic lifts. The control unit to operate the lift is located in the transom storage locker. See Figures M11 & M12. The breaker for the optional lift is located on the aft circuit breaker panel. Please read the manufacturer's literature regarding operation and maintenance of the swim platform lift.



**Figure M11: Extended Swim Platform Lift Option**



**Figure M12: Extended Swim Platform Lift Control**

## M - 8 TRANSOM STORAGE LOCKER

The transom storage provides storage for such things as dock fenders, personal flotation devices, dockside power cord(s) etc. The storage lockers use latches for easy access. To open, lift the handle. The latches are flush mounted to prevent injury or accidental opening. Gas-assist lifts hold the locker door open for ease of use. See Figure M13.



**Figure M13: Transom Storage Locker**

## M - 9 ELECTRIC GRILL

Grilling is available at the transom with the electric grill. The grill interior portion of the cover is mirrored. A contact switch on the grill's lid shuts off the grill should the cover be closed inadvertently while the grill is still on. The circuit breaker for the electric grill is located on the 240V AC cabin panel. Please read the manufacturer's literature regarding operation, safety and maintenance of the grill. See Figure M14.



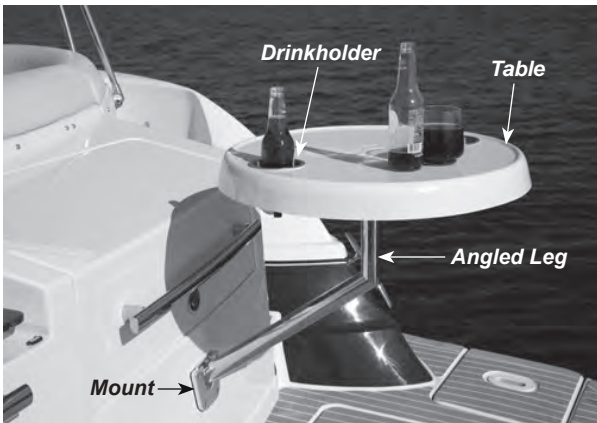
**Figure M14: Electric Grill**



*Care must be exercised while grilling. Keep children away from the grill's hot elements. Severe burns could occur.*

## M - 10 TRANSOM TABLE OPTION

To make grilling and swim platform activities even more enjoyable an optional transom table can be installed. The table mount attaches to the transom. The angled table leg and table can be easily installed and removed as desired. See Figure M15.



**Figure M15: Transom Table Option**

## M - 11 BOW PLATFORM

The V475 models are designed with an integrated bow platform. This bow platform provides a functional base for anchoring. The anchor is stored in the anchor chute of the platform. The anchor chute and bow roller provide support for the chain/rope and anchor. See Figure M16. Refer to Chapman's Piloting, Seamanship and Small Boat Handling or local anchorage authority for anchor type and size recommendation.

**WARNING**

*To prevent a possible man overboard situation, NEVER stand on, or try to utilize the bow platform in any way while the boat is underway.*

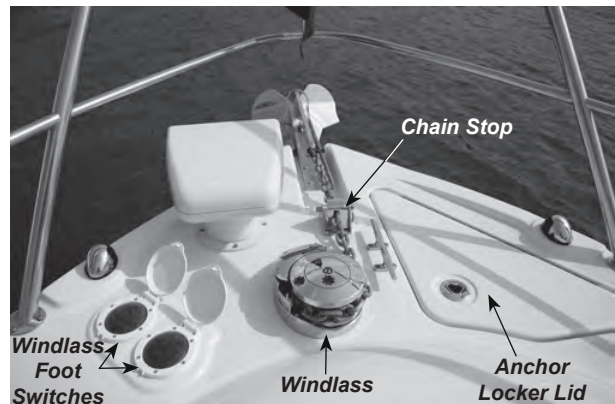


**Figure M16: Integrated Bow Platform**

## M - 12 WINDLASS

A windlass is an electrically controlled winch mechanism for retrieving the anchor. The mechanical winch

portion is mounted inside the anchor locker, at the bow. See Figure M17. The windlass can be controlled by a set of foot pads (electrical switches) mounted on the foredeck or it can be operated from the helm. Circuit breakers are located on the helm and aft circuit breaker panels. Refer to the manufacturer's literature included in the owner's packet for windlass operation.



**Figure M17: Windlass**

Along with the windlass comes an anchor, rope and chain. The anchor line is stored in the anchor line locker located underneath the anchor locker lid. The locker keeps the line secure while underway and keeps the deck clear of unsightly anchor line when docked. See Figure M17.

**WARNING**

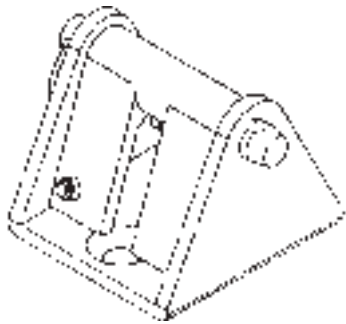
*To prevent personal injury, keep clear of the windlass at all times.*

**WARNING**

***Always be sure to raise and secure the anchor prior to operating your boat.*** Failure to raise and secure anchor before getting underway could result in severe injury or damage to boat from rebounding anchor.

**WARNING**

*Always utilize the chain stop provided with the windlass. The chain stop prevents the anchor from accidentally releasing while the boat is moving thus preventing damage to the boat or possible injury or death to individual(s) aboard the boat. See Figures M17 and M18.*



**Figure M18: Chain Stop**

### M - 13 SEARCHLIGHT

A remote controlled searchlight is installed at the bow. The searchlight uses an electric motor and helm switch controls to direct the searchlight's beam. See Figure M19. The circuit breaker is located on the helm circuit breaker panel. Refer to Section H-5 and the searchlight manufacturer's literature included in the owner's packet.



**Figure M19: Remote Searchlight**

### M - 14 UNDERWATER LIGHTING OPTION

Underwater lighting is an available option. With this option you can enjoy the view below the water. See Figure M20. If installed please refer to the manufacturer's literature included in the owner's packet.



**Figure M20: Underwater Lighting Option  
(Representative View Only - V475 not shown)**

### M - 15 HARD TOP

The hard top is swept forward in design. This presents a sleek look while providing an adequate platform necessary for installation of various navigation and communication equipment. See Figure M21. Four Winns offers an optional navigation package. Refer to Section E - 9F Navigational Equipment for additional information. Please consult with your Four Winns dealer regarding inquiries and availability.

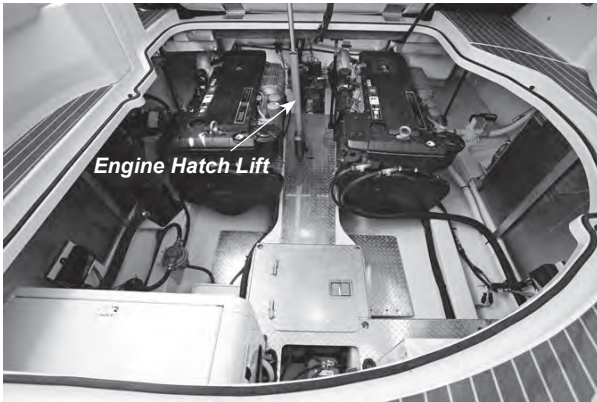


**Figure M21: Hard Top**

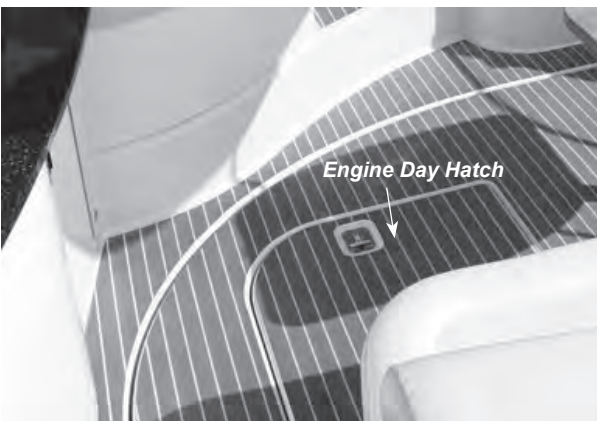
### M - 16 ENGINE HATCH w/ ELECTRIC LIFT

The V475 models feature an engine hatch with an electric lift or screw jack. The screw jack lifts and lowers the engine hatch by pressing the switch located on the dash. The screw jack runs off the house battery. For quick and convenient engine room access a day hatch is installed in the engine hatch itself. **Note:** When either the day hatch or engine hatch is open the engine room lights come on automatically. Exercise care when using steps leading into engine compartment. See Figures M22. & M23.





**Figure M22: Electric Lift for Engine Hatch**



**Figure M23: Engine Day Hatch**

To raise the engine hatch:

1. Remove the cockpit table (if currently installed).
2. Press the upper (top) portion of the engine hatch switch located on the helm to raise the engine hood to its open position.

**CAUTION**

*Do not have person(s) sitting in stern seat or standing on engine hatch while attempting to raise or lower the engine hatch. Possible injury to person(s) and/or damage to engine hatch and components may result.*

**NOTICE**

*Never operate your boat with the engine hatch in its open position. Doing so could result in damage to the engine hatch, hardware, and/or loss of cushions.*

**CAUTION**

***Always** close engine and day hatches when not working in engine room. Failure to do so could lead to person accidentally falling into engine room causing injury.*

To lower the engine hatch:

1. Press the lower (bottom) portion of the engine hatch switch located on the helm to lower the engine hatch to its closed position.
2. Reinstall the cockpit table (if so desired).

**NOTICE**

*Cushions, if not properly stored and secured, can blow out of the boat.*

**M - 17 FLAG POLE & HOLDER OPTION**

Feel free to show your colors with this flag pole and holder option (flag not included). The flag pole is quickly installed or removed from its holder by pushing in and rotating the pole. See Figure M24. Please consult with your Four Winns dealer regarding inquiries with regard to this popular option.



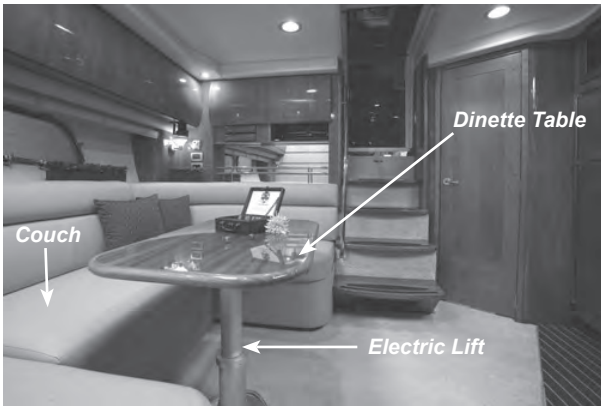
**Figure M24: Optional Flag Pole & Holder**



**N - 1 INTERIOR FURNISHINGS**

**A. Couch and Dinette Table**

The couch in the salon area of the main cabin converts to a berth using the dinette table. The dinette table is mounted on an electric lift, which when lowered becomes a fill-in support. Insert the fill-in cushion to complete the transition. Convenient storage is located underneath the couch seat bases. The switch to operate the table's electric lift is located in the galley, near the TV. See Figures N1 - N4.



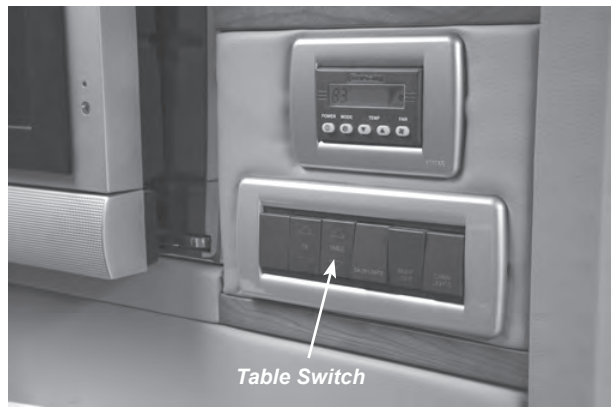
**Figure N1: Couch**



**Figure N2: Couch Converted to Berth**



**Figure N3: Under Seat Couch Storage**



**Figure N4: Dinette Table Switch Location**

**B. Master Stateroom**

Four Winns provides an inner-spring mattress with fitted sheets for the master stateroom. The master stateroom also comes with a woodgrain, locking door, under berth storage, cedar lined, hanging locker, private shower (in separate area other than the head) and stand-up head. See Figures N5 - N9.



**Figure N5: Master Stateroom w/Inner Spring Mattress**



**Figure N6: Drawer Storage**



**Figure N7: Under Berth Storage**



**Figure N8: Cedar Lined Hanging Locker**



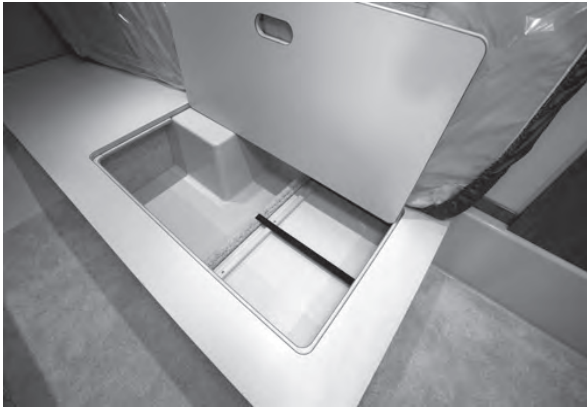
**Figure N9: Master Stateroom Head**

### **C. Mid Cabin Stateroom**

The mid cabin stateroom is equipped with oversized twin berths with fitted sheets. These twin berths can be converted into one large berth through the use of support boards and fill-in cushions. Privacy can be obtained through the use of the woodgrain, locking door. The mid cabin stateroom also includes the following, window with screen for ventilation, workstation/desk/dresser with drawers, cedar lined hanging locker, and head with shower. Additional storage is located beneath the cushions. See Figures N10, N11 and N12.



**Figure N10: Twin Berths**



**Figure N11: Storage Beneath Cushions**



**Figure N12: Workstation/Desk**



**Figure N14: Head w/Shower**



**Figure N13: Cedar Lined Hanging Locker**

 **CAUTION**

*To prevent personal injury, be sure the mid cabin fill-in supports are secure before use.*

**N - 2 EXTERIOR FURNISHINGS**

**A. Helm Seat**

The helm seat is double wide so it can seat two people comfortably. The driver's portion of the helm seat is adjustable. A 6-way electrical slider mechanism is mounted under the driver's seat. This allows the driver of the boat to adjust his or her portion of the helm seat to meet his or her needs. To adjust the helm seat, push the seat adjustment control lever in the desired direction you want the seat to go and then release to lock the seat into the desired position. There is approximately six inches of fore and aft adjustment available. The helm seat includes flip-up bolsters. By simply flipping up the bolster the driver and/or passenger is able to sit higher in the seat. This is designed to give the driver and passenger greater



flexibility, increased visibility, and riding comfort. See Figures N15 & N16.



**Figure N15: Helm Seat w/Bolsters**



**Figure N16: Helm Seat w/Bolsters in Raised Position**

**WARNING**

*DO NOT sit on the backrest portion of any cockpit seat. The operator could lose control of the boat or passengers could be thrown from the boat. The seat could also be damaged if excessive force is applied.*

The driver's side armrest is padded for comfort. The armrest is also hinged which allows the armrest portion to be raised to reveal convenient storage below. See Figure M17.



**Figure N17: Helm Seat Under Armrest Storage**

### B. Stern Seat

The custom L-shape stern seat includes a fiberglass base. The L-shape seating arrangement continues around the back of the boat to create more usable seating area. Under seat storage is readily available under the hinged stern seat cushions. Refer to Figures N18 and N19.



**Figure N18: L-Shape Stern Seating**



**Figure N19: Under Stern Seat Storages**

### C. Cockpit Table

An aft cockpit table is standard. The table is typically made of teak. **Note:** Other wood or material may be substituted without notice. See Figure N20. The table base is "flush" mounted for convenience and safety.



Please refer to Section Q for information regarding the care of the table.



**Figure N20: Aft Cockpit Table**

To set up the cockpit table:

1. Insert the table leg (approximately 26.5" long) into the floor mount.
2. Mount the cockpit table onto the table leg.

To remove the cockpit table simply reverse the procedure. Store cockpit table in the designated cockpit storage area of the refreshment center. See Figure M21. **Note:** This storage area is not available should the optional cockpit TV with electric lift be installed.



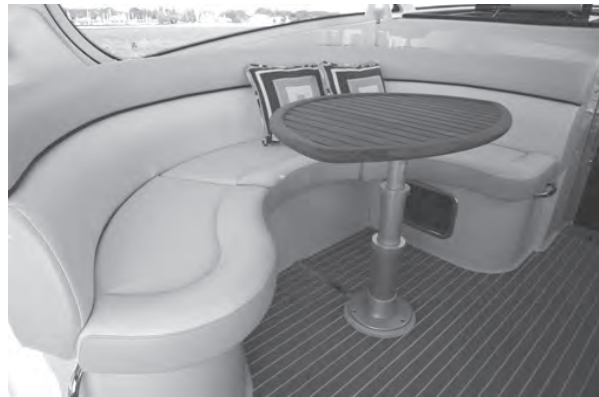
**Figure N21: Aft Cockpit Table Storage**

**NOTICE**

*To prevent damage to cockpit table and/or cockpit interior ensure the cockpit table and legs are properly stored.*

**D. Port Lounge**

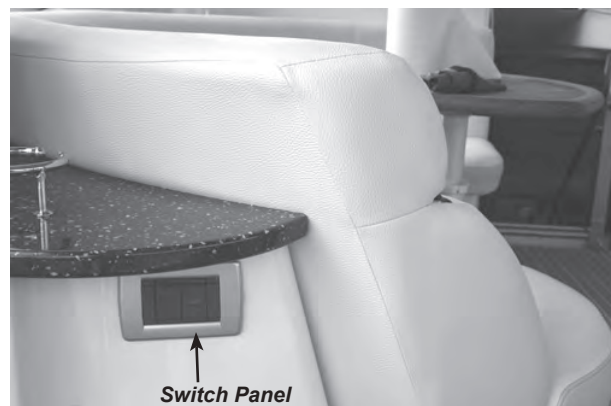
A port side lounge provides comfortable seating and includes a teak wooden table. The port lounge can quickly be converted to a berth. The table is mounted on an electric lift, which when lowered becomes a fill-in support. Insert the fill-in cushion to complete the transition. Convenient storage is located underneath the couch seat base. The switch to operate the table's electric lift is located at the aft port lounge countertop. See Figures N22 - N24.



**Figure N22: Port Lounge**



**Figure N23: Port Lounge Converted to Berth**



**Figure N24: Task Lights & Table Switch Panel**

Task lights provide additional lighting and are easily installed in the light base of the port lounge counter-tops. These lights screw into the bases and the switch to activate the lights are located on the same switch panel as that of the port lounge table lift. See Figures M24 & M25.



**Figure N25: Port Lounge Task Lights**

### E. Deck Sunpads

The sunpads are optional. These cushions securely snap in place and provide comfort while sunbathing on the foredeck. See Figure N26.

**WARNING**

*To prevent a possible man overboard situation, NEVER occupy the sunpads while the boat is underway. Use the sunpads when boat is at rest only.*



**Figure N26: Sundeck Pads**

## N - 3 INTERIOR UPHOLSTERY CARE

### A. Cleaning Interior Fabric/Upholstery

The fabric used in the cabin should be treated the same as fabrics in your home. Periodic vacuuming and gentle cleaning will keep the fabric and upholstery clean and odor free. Spraying the fabric/upholstery with Lysol Spray Disinfectant™ will help retard mildew. For vinyl care see N-4A.

A recommended "Cleaning Kit" includes:

- Westley's Clear Magic™ (for ordering information call 1-800-416-1600 or 800-321-8577; website address [www.westleys.com](http://www.westleys.com))
- Fast & Easy Glass Cleaner™ (to locate the nearest distributor, call 800-537-8990)
- Tough Duty Cleaner™ (to locate the nearest distributor, call 800-537-8990)
- Clean, white towels
- Portable/Compact Deep Cleaner Vacuum (Bissell Spot Lifter™ or similar product)
- Air hose (if available)

To remove stains, please refer to the following list for recommended cleaners.

1. Basic Stains/Ink/Grease/Pencil/Dirt:  
Westley's Clear Magic™
2. Adhesives/Teak Oil/Gum/Tar:  
Tough Duty Cleaner™
3. Water Stains:
  - a. While fabric is still wet, use a deep cleaner vacuum to go over the wet area. This will remove the stain from the fabric. It is always best to get the stain before it dries.

- b. For water stains that have dried, use a deep cleaner vacuum system. Follow the instructions that come with the deep cleaner system. Repeat if necessary.
- c. If this does not work we recommend a professional cleaning service. One such service is Service Master®. Please call 1-800-937-3783 for the Service Master location nearest you.

#### 4. Tough Stains/Set Water Stains:

- a. Spray Westley's Clear Magic™ on the area, going two (2) inches around the stain or if possible, bring wetness to a break point, such as a bulkhead, etc. Spray water on the same area as directed on the bottle.
- b. Let set approximately five (5) minutes.
- c. Rub the area with a clean towel, rotating the towel as the stain is removed. As you rub, go a little beyond the wetness with the towel, flaring the edges.
- d. Use a deep cleaner type vacuum to remove excess wetness. Allow to dry.
- e. Repeat if necessary.
- f. If stain still persists, use a professional cleaning service.

#### B. Interior Carpets

Four Winns V-series cruisers use a high quality interior grade carpeting. Interior carpeting should be cleaned in the same manner as the carpeting in your home. Vacuuming and occasional rug shampooing are recommended for extended life and appearance. Always conduct a colorfast check on a small area of carpet prior to applying the cleaning solution/shampoo on the entire carpet.

#### C. Privacy Curtains

After a season or more use and exposure, you may wish to remove the curtains. Dry cleaning is recommended. Most draperies can be taken down after removing the screw from the end of the curtain track.

This screw may not be accessible on some models. Should this be the case, remove the screws securing the end of the track. The track is flexible and can be lowered to remove the end screws.

## N - 4 EXTERIOR UPHOLSTERY CARE

### A. Cleaning Vinyl

#### NOTICE

*Vinyl upholstery should be cleaned and maintained in accordance with the manufacturer's recommendations and instructions.*

The vinyl material used on the exterior upholstery should be cleaned regularly with warm water and a mild dish soap or Vinyl Finish Vinyl Cleaner® using a soft clean cloth, then rinse with a soft clean cloth. For dirt buildup, spray Vinyl Finish Vinyl Cleaner®, let soak for approximately ten (10) minutes, then gently scrub with a soft bristle brush. Be sure to thoroughly rinse the vinyl after washing with mild dish soap or Vinyl Finish Vinyl Cleaner® to remove all residue. Towel dry the vinyl. Periodic spraying of the seats with Lysol Spray Disinfectant™ will help retard mildew.

To further protect the vinyl from early degradation, use 303 Aerospace Vinyl Protectant®. Spray on, then wipe dry. 303 Vinyl Protectant should be applied every 3-5 weeks when boat is in use. Regular cleaning with mild soap and water or Vinyl Finish Cleaner will not remove the 303.

#### NOTICE

*DO NOT apply vinyl protectants such as Armorall®. The manufacturer does not recommend this product because it removes the oils present in vinyl that keeps vinyl soft.*

### A recommended "Cleaning Kit" includes:

- Ivory Dishwashing Liquid™ and water
- Clean, white towels
- Soft bristle brush
- Denatured Alcohol
- Hemisphere Ink Remover® -  
(for ordering information call 800-247-9901)

- Vinyl Finish Vinyl Cleaner® - (everyday cleaning & care, call 800-247-9901)
- 303 Aerospace Vinyl Protectant® - (for ordering information call 800-247-9901)
- Tough Duty Cleaner™ - (to locate the nearest distributor, call 800-537-8990)
- Ammonia and hydrogen peroxide

To remove stains, follow the general guidelines listed below and/or refer to the Step-by Step Cleaning Instructions table:

### General Stain Removal Guidelines

#### 1. Basic Stains/Grease/Pencil/Dirt:

Ivory (mild) Dishwashing Soap™ and water, applied with a medium-soft brush or Vinyl Finish Vinyl Cleaner® using a soft clean cloth, then rinse with a soft clean cloth.

#### 2. Tough Stains/Adhesive/Teak Oil/Rust:

Tough Duty Cleaner™; rinse with soap and water or spray with Vinyl Finish Vinyl Cleaner®, let soak for approximately ten (10) minutes, then gently scrub with a soft bristle brush. Thoroughly rinse vinyl and dry.

#### NOTICE

*To prevent possible damage to the vinyl, rinse with soap and water after applying the Tough Duty Cleaner™ or Vinyl Finish Vinyl Cleaner®. Then rinse and dry.*

#### 3. Ink:

Denatured alcohol or Hemisphere Ink Remover®.

#### 4. Mildew Stains:

To kill bacteria creating the mildew, vigorously brush the stained area with a 4-to-1 mixture of water and ammonia; rinse thoroughly with water and dry.

#### 5. Tough Mildew Stains:

Apply a mixture of one (1) teaspoon ammonia, one-fourth (1/4) cup of hydrogen peroxide, and three-fourths (3/4) cup of distilled water; rinse with water and dry.

Step-by-step cleaning instructions				Legend
Type of Stain	STEPS: 1,	2,	3	
General Care	A	B		A. Medium-soft brush, warm soapy water Rinse / Dry
Dirt Build-up	A	B		
Ballpoint ink*	E	B	A	B. Vinyl Finish Vinyl Cleaner® Rinse / Dry
Chewing gum	D	A		
Coffee, tea, chocolate	B			C. One (1) tablespoon of ammonia; one-fourth (1/4) cup of water Rinse / Dry
Grease	D	B		
Household soil	A	B		D. Wipe or scrape off excess (chill gum with ice before hand)
Ketchup	A	B		
Latex paint	A	B		E. Hemisphere Ink Remover Rinse / Dry
Lipstick	A	B		
Mildew or wet leaves*	C	B	A	
Motor oil	B			
Oil-based paint	D	B		
Permanent marker*	E	B	C	
Spray paint	B			
Suntan lotion*	A	B		
Tar / Asphalt	D	B		
Yellow mustard	A	B	C	

All cleaning methods must be followed by a thorough rinse with clean warm water.

Certain household cleaners, powdered abrasives, steel wool and industrial cleaners can cause damage and discoloration and are not recommended. Dry cleaning fluids and lacquer solvents should not be used as they will remove the printed pattern and gloss. Waxes should be used with caution as many contain dyes or solvents that can permanently damage the protective coating.

\*Suntan lotion, tree pollen, wet leaves and some other products can contain dyes that stain permanently. Care should be exercised and boat covers should be utilized.

**Step-By-Step Vinyl Cleaning Instructions Table**

#### Do's

- Vinyl Finish Vinyl Cleaner
- Dish Soap (Dawn, Ivory)
- 303 Aerospace Protectant

#### Don'ts

- Formula 409
- Fantastik
- Simple Green



- Armorall
- Murphy's Oil Soap,
- Son-of-a-Gun
- Bleach / Baking Soda
- Turtle Wax
- Tar Remover

**NOTICE**

*Failure to care for your vinyl properly, or use of improper cleaners may void your warranty and damage your vinyl.*

**NOTICE**

*When docking or mooring your boat be aware of your surroundings i.e. trees with pollen, wet leaves, berries etc. These and other items can contain dyes that stain permanently. Utilize weather covers whenever possible to protect vinyl from potential stains.*

**NOTICE**

*ALWAYS CLEAN STAINS IMMEDIATELY! DO NOT use Formula 409™ Fantastik™, Simple Green™, Armorall™, Murphy's Oil Soap™, Son-of-a-Gun™, Bleach / Baking Soda, Turtle Wax™ or Tar Remover on vinyl. Do not use kerosine, gasoline or acetone as they will remove the protective marine topcoat.*

**NOTICE**

*All cleaning methods must be followed by a thorough rinse with water and drying.*

Additional cleaning information is provided by the manufacturer and is included with this manual.

Four Winns offers a variety of optional weather covers for protection of the boat and associated equipment. Continued exposure can damage the upholstery and seating. The seating can become thoroughly saturated with water if not adequately protected. Refer to Section O - Weather Covers for more information.

**NOTICE**

*The appearance and longevity of the exterior upholstery will be affected by water saturation. Protect these items appropriately.*

**B. Exterior Carpets**

The removable exterior grade carpeting may be periodically washed with mild laundry soaps or shampooed, dried and reinstalled. It is 100% UV stabilized Olefin™ polypropylene fiber with rubber backing. See Figure N27.

**NOTICE**

*Prior to using any mild laundry soaps or carpet shampoo, always conduct a color-fast test on a small inconspicuous portion of carpet before applying to entire carpet.*

**NOTICE**

*DO NOT dry carpeting in an automatic dryer.*



**Figure N27: Cockpit Lay-in Carpet**

**C. Cleaning and Maintenance**

The following information should be useful in helping you keep your carpet looking well maintained.

Carpet made with Olefin™ fiber possesses built-in stain and soil release for easy, less costly maintenance. Regular vacuuming and occasional shampooing will help it stay attractive and serviceable.

**D. Stain Removal Testing**

Even the most stubborn stains can be removed from Olefin fiber following the procedures outlined. Stains were selected as being representative of spills commonly occurring on carpets. Stains were pressed into the carpet to simulate foot pressure following a spill. Stains were applied to a two-inch square section and allowed to penetrate. Removal was performed after two weeks. Carpets were tested for stain removal by an independent laboratory. Stain removal was effective for all the stains selected. Results are shown in the table on the following page.

## E. Stain Removal Procedures

Regular maintenance such as vacuuming, hosing or washing should be performed. Most stains and mildew are easily removed from carpet made with Olefin fiber using common household cleaners. Refer to Table I. Olefin™ fiber is so resistant to chemical attack that Clorox™ bleach may be used to clean up any mildew that may result from excessive wetness.

### Code for stain removal procedure (See Table 1):

“A” Apply warm water and household detergent in minimal amounts to stained area. Sponge or scrape until stain is removed. Rinse with clean water.

“B” Apply warm water and household detergent. Work well into stained area then flush with warm water.

Most stains should be easily removed however, if the stain persists, the cleaning procedure should be repeated to insure stain removal. Remember, the sooner the stain removal process begins, the easier the stain will be to remove.

#### NOTICE

*Do not use dry cleaning solvents on carpet or vinyl. Permanent damage to the fiber will result.*

## N - 3 REPLACEMENT UPHOLSTERY

Should upholstery become severely soiled, torn, or in some manner damaged, replacement upholstery cushions are available. Larger upholstery items have separate component parts for easier serviceability.

Depending upon the year and model of the boat, most upholstery parts can be obtained through your Four Winns servicing dealer within a short period of time.

STAIN	REMOVAL PROCEDURE
Automotive Grease	A
Automotive Oil (New or Used)	A
Bacon Grease	A
Berry Stain	A
Blood	A
Butter	A
Catsup or Mustard	A
Chewing Gum	A (Repeat)
Chlorine Bleach (5%)	A
Chocolate (Melted)	A
Clay	A
Coffee or Tea	A
Cola	A
Crayon	B
Dye	A
Egg	A
Feces	A
Fish Formula	A
Fruit Juice	A
Furniture Polish	A
Gravy	A
Ice Cream	A
Ink (Permanent Black)	B
Ink (Scripto, Ballpoint)	B
Iron Rust	A
Lipstick	B
Mayonnaise	A
Milk	A
Latex Paint	A
Oil Base Paint	B
Polish	B
Rust	A
Salad Dressing	A
Shaving Cream or Lotion	A
Tar	B
Urine	A
Vomit	A
Water Colors	A
Wax	B
Wine	A

**Table I: Stain Removal**

**O - 1 GENERAL INFORMATION**

Weather covers for the cockpit areas are available on all Four Winns® models. A canvas top with a curtain set is standard on the V475 models. This cover is designed and intended to provide protection of the stern cockpit seating area.

Four Winns utilizes 100% acrylic-type material for most of its canvas. During the manufacturing of the weather covers, the smallest possible needle and highest quality UV stabilized, bonded polyester thread is used in the stitching.



*Never use any form of open flame cooking device in any area fully enclosed or near weather covers. This material is flammable.*

The weather cover is water repellent but not water proof. During a hard rain, you may notice a light mist permeating through a weather cover. This is normal. If the seams leak, they can be sprayed with Scotch-guard™ or similar type water repellent or a seam sealing compound can be applied. Keep objects from contacting the inside of the cover. Leakage may occur at point of contact.

Weather covers must be installed “snug” to prevent sags. The material relies on swelling to seal itself. If too taut or overly tight, the material will not seal and may tear.

**NOTICE**

*Periodically check weather covers for accumulation of water. Damage to the bow assemblies may otherwise result. Make sure cover is snug to avoid puddling of water.*

When storing weather covers, the canvas pieces should be stored flat or rolled up and properly stowed. Do not fold canvas.

**NOTICE**

*NEVER fold or store a wet weather cover. This can lead to mildew or shrinkage. Roll rather than fold the enclosure curtains. Sharp folds increase the chance of cracking the clear vinyl.*

**NOTICE**

*DO NOT use the weather covers for outdoor winter storage. The weight of the snow or heavy rain can cause severe damage to the material or top structure. Refer to O-7 - Winter Storage in this manual for more information.*

Four Winns is utilizing snaps for the canvas. The snap sockets are a standard type. To unsnap, gently lift on the snap.

**NOTICE**

*Remove snaps one at a time to prevent damage. DO NOT rip off or pull the weather cover as a whole; acrylic material will tear at snaps.*

**O - 2 GENERAL CANVAS INSTALLATION GUIDELINES**

- 1) For safety and ease, it is recommended that two or more people are available to install or remove the canvas.
- 2) Ideally, canvas should be installed while the boat is in the slip or moored securely.
- 3) Be sure to observe all safety precautions to prevent the build-up of Carbon Monoxide - an invisible, odorless gas while the boat is running or underway.
- 4) Store canvas pieces flat, or if necessary, rolled; do not fold.
- 5) Valances and/or canvas top must be installed first; all other pieces attach to these pieces.
- 6) Partially zip zippers until all sides of a canvas piece are in position.
- 7) Support poles are adjustable; a button-release lets you slide the inner and outer tube to longer or shorter settings for a snug fit.
- 8) Unsnap canvas by lifting at the button to prevent damage; do not pull/yank.

- 9) Clean canvas with warm water, mild soap and a soft brush. For the clear Izinglass pieces use a soft, clean cloth. Be certain to rinse cloth often to remove any dirt collected in the cloth that could scratch the clear vinyl.

### O - 3 CANVAS INSTALLATION

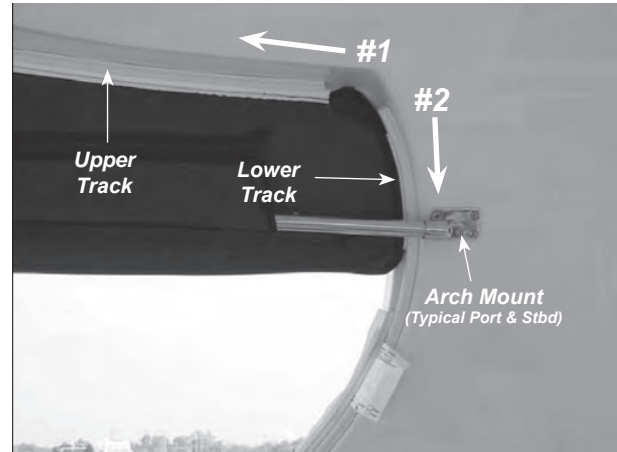
The canvas top and curtain set which connect to the top are standard and provide cover/shade for the stern portion of the cockpit area. It is designed to be fastened to the hard top with the use of a track and supported with stainless steel bow and support poles. The aft curtain and side curtains can be installed to completely enclose the aft cockpit area. Izinglass (clear vinyl) windows with screens are installed in the curtains. These windows may be rolled up and secured to allow ventilation into the cockpit area. See Figure O1.



**Figure O1: Canvas Top & Curtain Set**

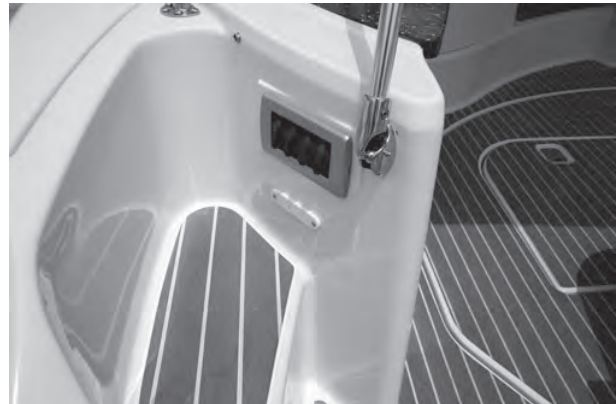
To install canvas:

- 1) Orient the canvas top to match the orientation of the hard top. Ensure the interior seams will be facing inside. Starting at either end, thread the opposite end of the canvas through the upper track of the hard top (#1). Continue feeding the canvas all the way through the track until completely threaded. Feed ends of canvas top into the lower track running down the hard top (#2). See Figure O2. Once the canvas top is installed in the tracks, allow it to hang in place.



**Figure O2: Upper & Lower Tracks and Arch Mount**

- 2) Attach the stainless steel bow to the port and starboard arch mounts using an adjustable wrench. See Figure O2.
- 3) Attach the support poles to the respective port and starboard deck mounts located at the transom. Slide the support poles down into the deck mount and secure with the pin and lanyard. See Figure O3.



**Figure O3: Bow Support Pole Deck Mount**  
(Typical Port & Starboard)

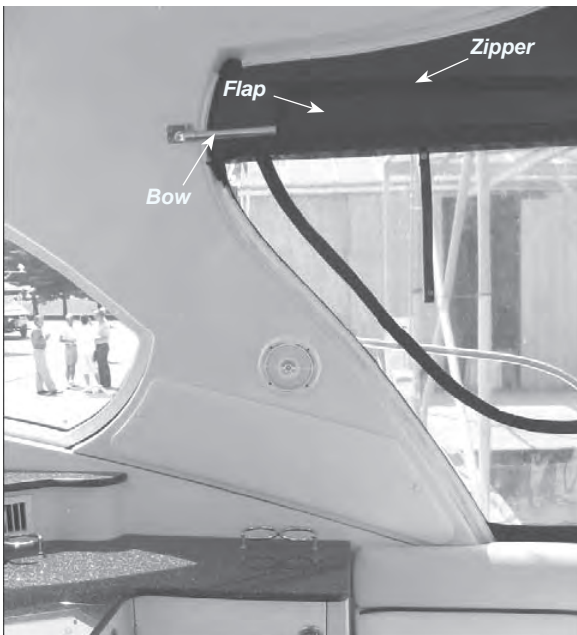
- 4) Lower the adjustable supports using the button-release. The button-release lets you slide the inner and outer tube to longer or shorter settings for a snug or loose fit. Doing so may make attaching the top canvas to the bow easier. See Figure O4.





**Figure O4: Adjustable Bow Support Poles**

- 5) Place the canvas top over the bow. Wrap the zippered-flap portion of the top around the bow and zip securely in place. See Figure O5.



**Figure O5: Zippered-Flap Portion of Canvas Top**

- 6) Raise the adjustable supports using the button-release in order to make the canvas top taut. See Figures O4 and O6.



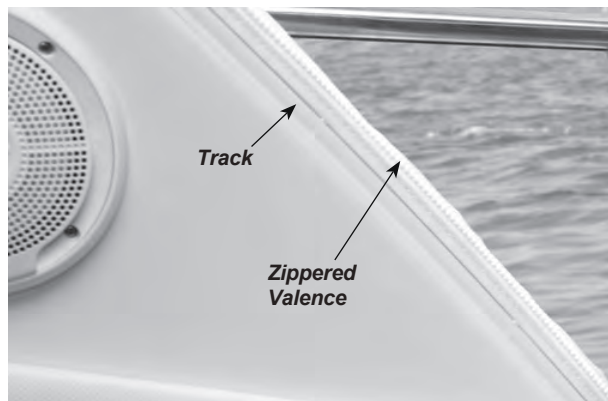
**Figure O6: Canvas Top**

**NOTICE**

*Canvas should be snug. If overly taut or extremely tight, canvas could tear or pull at seams.*

To install the sides & aft curtains:

- 1) Lower the adjustable supports using the button-release. The button-release lets you slide the inner and outer tube to longer or shorter settings for a snug or loose fit. Doing so may make attaching the sides & aft canvas to the boat easier. See Figure O4.
- 2) Valances, small areas of canvas curtain, are used to attach the side curtains to the boat. The valances slide through a track mounted on the hard top. The side curtains are then attached to the valances using zippers. See Figure O7.



**Figure O7: Side Curtain Valance**

- 3) Starting at the top, start each zipper.
- 4) When all zippers have been started, complete zipping.
- 5) Snap the side curtains to the boat.
- 6) Zip the aft curtain to the canvas top, starting at one end. See Figure O8.



**Figure O8: Aft Curtain**

- 7) Zip to port and starboard curtains.
- 8) Secure the bottom of curtains to the transom of the boat using the snaps.
- 9) Raise the adjustable supports using the button-release in order to make the canvas sides & aft curtains taut. See Figures O4 and O8.
- 10) Secure and smooth all velcro.

#### NOTICE

*The canvas top has been designed and intended to remain installed on the boat. Four Winns does not recommend the canvas top and bow assembly be removed from the boat unless necessary or desired.*

#### NOTICE

*Two people are recommended if removal or installation becomes necessary. Care must be exercised so the hard top does not become damaged. Use a protective covering to prevent damage to hard top if necessary.*

#### NOTICE

*In the event the canvas top requires some maintenance or repair, remove the canvas top from the bow assembly.*

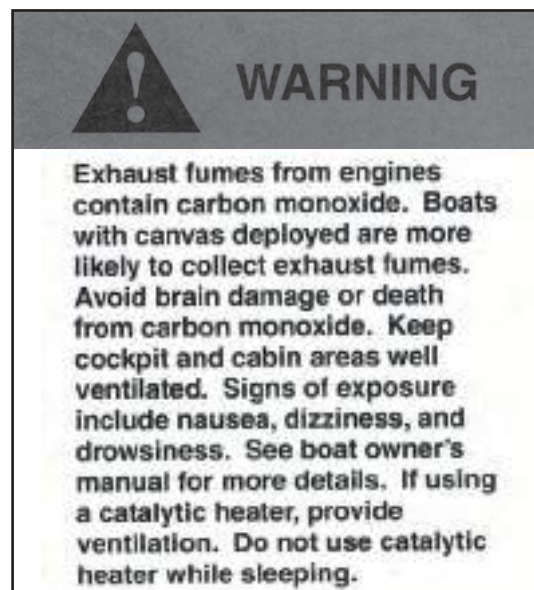
#### NOTICE

*It is recommended that you retain your canvas locator tags. In the event that replacement parts are needed, contact your Four Winns dealer.*

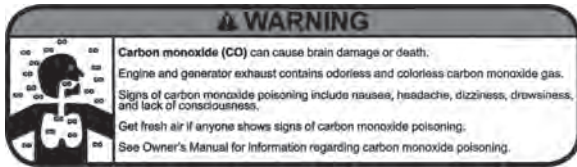
### O - 4 USE OF WEATHER COVERS AND CARBON MONOXIDE

When an engine is running, a natural vacuum may exist with the right wind and sea conditions to allow exhaust gases (which includes carbon monoxide) to seep into the boat. When canvas is utilized, this compounds the possibility of this occurring and inhibits natural ventilation. For more information, refer to Section B-2 - Carbon Monoxide in this manual.

The carbon monoxide in exhaust fumes can be hazardous. It is important for you and your passengers to be aware of the potential safety hazard created by exhaust fumes. Familiarize yourself with the symptoms of individuals overcome by carbon monoxide, and most importantly, ways you can protect yourself and your guests. See Figure O9 - Carbon Monoxide Canvas Warning Label and Figure O10 - Carbon Monoxide Warning Label.



**Figure O9: Carbon Monoxide Canvas Warning Label**



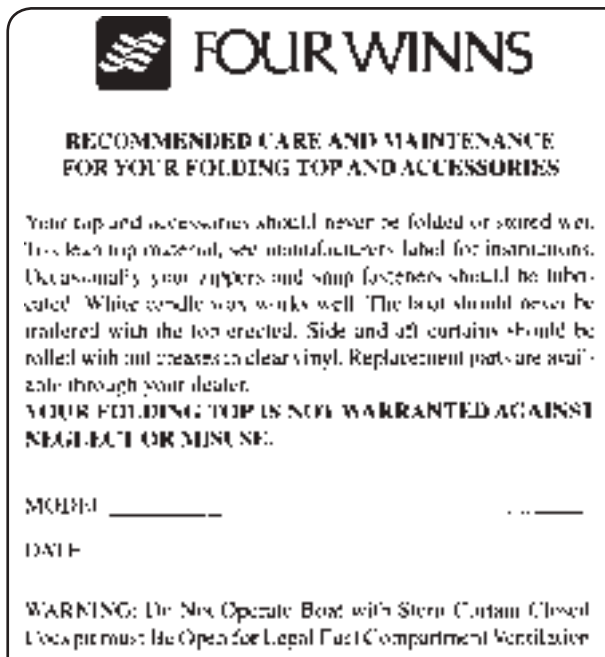
**Figure O10: Carbon Monoxide Warning Label**

## O - 5 WINTER STORAGE

The boat must be properly protected during winter dry dock storage. A winter storage cover is advisable. Many marine dealers offer shrink wrap enclosures for outdoor storage. See a Four Winns dealer for information on the availability of winter storage covers or other alternatives for storage.

When storing outdoors, make sure the supporting framework keeps the weight of the snow and rain from accumulating on the storage cover. Proper ventilation must also be provided or dry rot and mildew will occur. See Section R - General Maintenance for additional winter storage information.

## O - 6 MAINTENANCE



**Figure O11: Canvas Care & Maintenance Tag**

Moisture, dirt, chemicals from industrial fallout, heat, ultraviolet rays and in some cases, salt water are factors which affect the longevity of acrylic covers. See Figure O11.

1. Moisture can cause shrinkage and mildew. Allow the cover to dry thoroughly before disassembling tops. Keep it clean and well ventilated to prevent mildew. Spraying the weather cover with Lysol Disinfectant™ or similar product will help prevent mildew.
2. Dirt creates a starting point for mildew when moisture is present. Clean the top with a sponge or soft scrub brush and mild detergent when the cover is installed. Make sure cover is snug to help prevent shrinkage.
3. Chemicals cause decay if allowed to accumulate for long periods of time. Keep the cover clean to prevent decay.
4. Heat can cause cracks in vinyl components and stiffening of fabric when enclosed in plastic or polyethylene. DO NOT store the weather cover in polyethylene under direct sunlight or high temperature situations.
5. Ultraviolet degradation may occur under prolonged exposure to direct sunlight. Store the top in the boot when not in use.
6. Salt water can corrode brass, aluminum, or stainless steel fittings and fasteners. Keep fittings clean, lubricated, and waxed to prevent corrosion.

Clear vinyl curtains and windows demand extra care to prevent scratching. Hose clean water onto vinyl to rinse off salt, dirt, or grime prior to using a soft, clean cloth. Dirt or grit in the cloth will scratch the vinyl window. Be sure to rinse cloth often.

### NOTICE

*DO NOT use hot water. DO NOT dry in an automatic dryer. DO NOT dry clean or steam press.*

Leakage after cleaning may be the result of insufficient rinsing. Re-rinse. If leakage continues, apply a coat of silicone air drying water repellent, such as Scotchguard™. See your Four Winns dealer for additional information on weather covers.

**P - 1 HULL DESIGN INFORMATION**

Four Winns® boats are designed using the sound engineering and mathematical principles of hydrostatics, hydrodynamics, structure, and strength of materials. The materials utilized provide optimum strength at the lightest possible weight. The exact fiberglass laminate schedule and construction techniques of each part is determined in accordance with the strength and rigidity required.

**P - 2 FIBERGLASS CONSTRUCTION**

The fiberglass components of Four Winns® boats are of the finest quality materials, workmanship and construction techniques available. This ensures the structural integrity to provide years of boating enjoyment with minimal maintenance.

The construction of a Four Winns® hull begins with the application of gel coat to the mold. The gel coat is approximately 25 mils thick. A coat of resin and chopped fiberglass is then sprayed into the hull and carefully hand rolled until it is securely affixed to the gel coat.

A number of fiberglass layers and woven roving are applied to the above laminate. Each layer is hand laid and hand rolled. The keel and chine areas have fiberglass woven roving overlapped in these areas to provide additional strength. Most V Series models utilize encapsulated end-grain balsa core or coremat laminates to achieve additional rigidity. Others utilize additional laminations of woven roving to maintain strength and rigidity.

The hull support stringers are located using special tools, and are fiberglassed and/or bonded into place. This ensures a strong, rigid hull, permanently formed into a solid assembly, free of distortions.

Fiberglass cockpit liners and seat base are constructed similar to the hull. Balsa core or coremat laminations are utilized when necessary.

In addition to a thorough visual inspection of each fiberglass component, samples are measured using special equipment, for fiberglass reinforcement to resin ratio, laminate configuration, weight and thickness. By these procedures Four Winns ensures proper composition.

**P - 3 EQUIPMENT INSTALLATION**

Many boats are used for specific purposes or under conditions which require the addition of special equipment to the hull or deck. Special care must be taken during the installation of any equipment to a fiberglass component. A polysulfide or butyl based sealant should be used to seal installations below the water line. Silicone "marine" seal or similar bedding compound should be used elsewhere.

**NOTICE**

*DO NOT install any item onto or through the hull without adequately sealing the hull area penetrated by the installed item or related fasteners. Improper installations could cause leakage or allow water absorption and thus cause serious hull damage.*

*Always pre-drill fastening holes with a proper size bit. Pre-drilling will help prevent the fiberglass from splintering and thus causing unsightly damage. Also, countersink holes to prevent the gel coat from chipping.*

Any equipment which will be subjected to cyclic loading or significant force should be through-bolted to a fiberglass component. A butt block or backing plate should be used to strengthen any area onto which an item will be mounted.

**P - 4 FIBERGLASS CARE & MAINTENANCE**

Fiberglass is affected by weathering processes and requires maintenance on a periodic basis to help maintain the beauty and shine. The effects upon the gel coat will be dependent upon boating conditions, storage, type of use, and the care given to the boat during the boating season.

Four Winns utilizes fade-fighting gel coat in the exterior finish. It is specially formulated to resist fading and yellowing, and retain more of its original gloss than better grade gel coats. However, it is still important to maintain the gel coat to protect the finish.

**A. General Maintenance**

For fresh water use, the boat should be washed once or twice a month. When using in a salt water environment, considerably more care will be necessary. Be careful when selecting a cleaning agent. Hand dish



washing detergents are usually gentle and are recommended for cleaning gel coat. Cleaning products such as Ivory™ or Dawn™ hand dish washing liquid can be safely used. Always read the label before using any product.

#### NOTICE

*DO NOT use acetone, paint thinner, solvents, or strong alkaline based detergents, nor cleaners with a "gritty" and abrasive texture. Avoid products which contain sodium phosphate. Common examples of these types of household cleaning agents are: Tide™, Oxydol™, Janitor-in-a-Drum™, Fantastik™, Clorox™, etc. Always read the label before using an agent.*

There are several products available which are specifically designed to clean fiberglass exterior finishes. Many companies like Johnson & Johnson®, Turtle Wax®, etc. manufacture cleaning fluids mild enough to clean without stripping the wax.

#### NOTICE

*Treading on a soiled fiberglass surface can severely scratch and mar the finish. Keep the fiberglass as clean as possible.*

When cleaning skid-resistant areas, DO NOT attempt to use a wire brush or sandpaper because this will remove the skid-resistant gel.

Apply wax once or twice a year to maintain gel coat lustre. Read the label before using any product. Make sure product is formulated for gel coat surfaces. Also, consult a Four Winns dealer for their recommendations.

#### NOTICE

*Do not use carnuba based waxes. This type of wax yellows over time and makes the fiberglass appear yellow.*

#### CAUTION

*Waxing decks, cockpit floors or other walking areas is not recommended. Waxing will produce a very slippery surface, especially when wet. Wax may also buildup in the skid-resistant surfaces. Be sure all persons wear deck shoes while aboard the boat. Footing will be improved and feet will be protected from accidental cuts and bruises.*

A darkening or discoloration of the skid-resistant surfaces can sometimes occur as a result of wax buildup. Exposure to the sun and elements can turn the wax darker, or occasionally can cause it to become flaky or powdery. To remove, use fine rubbing compound and a low rpm buffer (1200 to 2000 rpm). Apply light pressure and keep the buffer moving at all times to prevent heat build-up. Read the directions before using any equipment.

#### B. Weathering Effects on Gel Coat

Weathering occurs from direct sunlight, water, chemicals, and dust. Some of the terms below describe the changes that can occur to the gel coat surface.

Chalking is a result of the gel coat's top surface being broken down into an extremely fine powder. When this happens, the color whitens. The chalk is present on the surface only.

Fading is the uniform change in color. This happens when the actual pigments have changed color, especially from excessive chalking, or when the gel coat has either been stained or bleached by something.

Yellowing is gel coat which has a yellow cast and streaking usually deals with a stain or contact with another surface.

Gloss refers to the shine of the surface. This can change from sanding action, chalk, residues, or exposure.

Blistering refers to a condition in which the unprotected gel coat surface below the waterline has absorbed water and formed bubbles. See Section P-5 for additional information.

Follow the ensuing instructions for boats that have weathered and chalked.

1. Wash.
2. Wax. If this does not work, then use a fine rubbing compound. If this does not work use 400 or 600 wet or dry sandpaper, followed by fine rubbing compound and wax.

When using wax or fine rubbing compounds, make sure to read the label and follow the directions. Some helpful tips are listed below.

1. Avoid working in direct sunlight. This dries out the wax or compound, and can stain the surface.
2. Use clean pads or cloths to apply a thin coating of wax or rubbing compound to a small area such as three feet by three feet. Remove any excess, and then rub the area with a buffing pad, or power buffer. Apply pressure only as necessary to restore the surface finish. Applying too much pressure or buffing in one place too long can permanently damage the surface.
3. After applying compound, always follow with waxing.

#### NOTICE

*If using a power buffer, use a low RPM buffer with light pressure. Keep the pad wet and the buffer moving at all times to prevent heat buildup.*

#### NOTICE

*To prevent gouges, uneven areas, or other damage from occurring, DO NOT use a power or belt sander when sanding. For best results, block sand the gel coat.*

### C. Stains

Stains can appear anywhere on the exterior of the boat and may be a result of contact with tar, plant sap, leaves, rust from metal fittings, and other materials. Surface stains may be removed with hand dish washing soap, mild cleansers, or some household detergents. DO NOT use chlorine or ammonia products. These products can affect the color of gel coat. Commercial car washes use strong cleaners and should be avoided.

To remove stains, refer to the following procedures.

1. Wash area with hand dish washing soap.
2. Begin with a small area such as three feet by three feet and apply a mild cleanser.
3. Rinse with clean water.
4. Follow with compound and waxing as outlined in procedure above.

If the stain is not removed by the hand dish washing soap or mild cleanser, then the next procedure is to use either denatured or rubbing alcohol. If this does not work, consult your Four Winns dealer for professional assistance.

#### NOTICE

*DO NOT use acetone, ketone, or other solvents to remove stains. These chemicals are flammable and may damage the gel coat.*

### P - 5 FIBERGLASS REPAIRS

Fiberglass is one of the most durable, strong, and forgiving construction materials afloat. It is resilient and normal repairs can be made without affecting the strength or structural integrity of the boat.

#### WARNING

*Striking docks, other boats, or submerged objects could create a very hazardous situation or severely damage the fiberglass. In the event an object is struck below or near the waterline, proceed directly and cautiously to the nearest service facility and remove the boat from the water. Closely inspect the hull for damage. If the outer fiberglass laminate was penetrated, repairs must be made prior to relaunch.*

Occasionally, blisters, crazing, scratches or damage to fiberglass can occur. Repairs may be necessary to correct the problem.

#### A. Scratches

Scratches occur during normal use. The following is a step by step procedure to repair scratches.

1. Clean area with soap and water.
2. Apply a fine rubbing compound and buff.

### 3. Wax.

If this does not work, clean the area and sand lightly with 400 to 600 wet or dry sandpaper and follow with rubbing compound and wax.

## B. Gouges & Cracks

Stress cracks and crazing are the appearance of hairline cracks in the gel coat surface. When present, these problems usually occur in the gel coat finish or the outer “skin coat” fiberglass laminate. The appearance of these cracks does not pose a threat to the structural integrity of the boat. In most cases, they are cosmetic and can be treated.

Cosmetic surface damage can be repaired as follows:

1. Sand the surrounding area with medium or fine grit sandpaper. Clean all marine growth, dirt, anti-fouling paint, etc. from the immediate area. DO NOT excessively scratch or gouge the surrounding area.
2. Use a hard, pointed tool to open the gel crack. Take care not to damage the surrounding gel coat.
3. Sand the crack or gouge so the edges are smooth and will allow proper “feathering” of the area.
4. Clean the area thoroughly. Make sure the area is dry before proceeding.

### NOTICE

*Be sure the structure and the ambient temperature are above 60 degrees F (15 degrees C) and the relative humidity below 70% immediately before, during, and after the repair.*

5. If the nick or gouge is deep and penetrates through the gel coat, fill the area with fiberglass patching paste. Follow the directions on the can when mixing the paste with the catalyst.
6. After the gouge is filled and has dried, sand the patched area. Begin by using medium-fine grade sandpaper. Progressively use finer grade sandpaper until the surface is very smooth. If necessary, add filler and then sand the surface again.
7. Apply two or three light coats of matching fiber-

glass gel coat to the repaired area. Enough gel coat should be used so that the entire area is covered. The gel coat must be catalyzed using up to 2% MEK Peroxide which can be purchased at a supplier handling fiberglass reinforced products. Contact your Four Winns dealer for assistance.

8. After ample drying time, sand the area using very fine wet/dry sandpaper. If the appearance of the area is still not satisfactory, repeat steps 2 through 4 as necessary.
9. If above the waterline, polish the area using a fiberglass rubbing compound and then wax. If the repaired area is below the waterline, the area should be primed and painted in accordance with the anti-fouling paint manufacturer’s instructions.

Gel coat, like paint, will change colors with time and exposure to sunlight (ultraviolet). For this reason, “matching” gel coat obtained from Four Winns may not match the gel color of a boat that has been exposed. However, this is the closest match commercially available. A fiberglass technician can tint the gel to be used in the repair to provide a closer color match.

More severe fiberglass damage, especially when structural, requires the expertise of an experienced fiberglass repair technician. See your Four Winns dealer for assistance.

### NOTICE

*Improper repair techniques can lead to further fiberglass component damage.*

## C. Osmotic Blistering

Osmotic blistering or “boat pox” is an unfortunate but not uncommon occurrence in fiberglass boats. Fiberglass is water retardant, not waterproof. When a boat is left in the water for a period of time, the fiberglass will absorb water. It is a natural process that can not be eliminated in production methods or material selection and usage. However, there are ways to control and possibly prevent blisters (see Section P-6). If you do encounter blisters, be assured that the blisters are merely cosmetic. They do not indicate a defect in the boat structure or lamination. Four Winns, along with most boat manufacturers, regard gel blisters as a standard maintenance item.

The repair procedure for gel coat blisters is similar to the procedures outlined in the previous section on cracks and gouges. There is an exception however, in that the hull must dry out for several days or possibly weeks before repairs can proceed.

To determine if the hull has dried sufficiently, tape one square foot of household plastic wrap securely to the hull bottom. Make sure all edges are sealed and let it stand for twenty-four hours. If condensation has accumulated under the plastic, the hull is still “wet” and must be allowed to dry longer before repairing.

When the repair is completed, an application of an epoxy barrier coat should be considered. This will help prevent the possibility of reoccurrence of blisters. Your Four Winns dealer or local ship store will have information on barrier coat products.

## P - 6 ANTI-FOULING PAINT

Four Winns recommends anti-fouling or bottom paint for boats which will be kept in the water for extended periods of time. Anti-fouling paint reacts with water to retard the growth of algae, barnacles and other marine growth on the hull. In addition to marine growth, it offers protection against excessive water pollution.

### NOTICE

*Most countries have introduced legislation controlling the use of anti-fouling agents. Always abide by these regulations.*

Anti-fouling paint begins reaction upon contact with water. After a season’s use or sooner under certain conditions, the anti-fouling paint may appear to be dissolving. This is due to the paint’s chemical emission that in turn retards marine growth. When this occurs, refinishing is in order. For bottom paint line location, refer to the Figure P1 at the end of this section. Also consult your engine operator’s manual for their recommendations regarding drive-unit and anti-fouling paint.

Four Winns recommends reapplication of the anti-fouling paint seasonally. The effectiveness of the paint will be drastically reduced if used longer. Though Four Winns has found the anti-fouling paints used to provide good marine growth protection in most water, other paints may be more effective in certain water conditions. See a Four Winns dealer for recommendations on anti-fouling paint use in your area.

### NOTICE

*During surface preparation, the hull should be sanded only enough to remove any foreign matter, and loose paint. DO NOT sand deeply into the gel coat, fiberglass cosmetic problems could later result. After sanding, the surface should be wiped with a rag treated with a cleaner recommended by the anti-fouling paint manufacturer. The surface must be clean and slightly rough to ensure paint adhesion.*

Prior to application of the anti-fouling paint, the boat owner may consider coating the hull bottom with an epoxy coating. Four Winns recommends this procedure as a preventive and effective means of controlling osmotic blistering. Most major anti-fouling paint manufacturers also supply a line of epoxy undercoatings. Consult your Four Winns dealer for recommendations on epoxy undercoatings.

## P - 7 HULL SUPPORT

Proper support of the hull while it is out of the water is imperative. Due to the design complexities, Four Winns does not recommend storage cradles be homemade. The boat is a valuable piece of equipment. DO NOT risk permanent damage to the hull structure in an attempt to save the cost of an adequate support. Improper support can lead to serious and permanent hull deformation.

### CAUTION

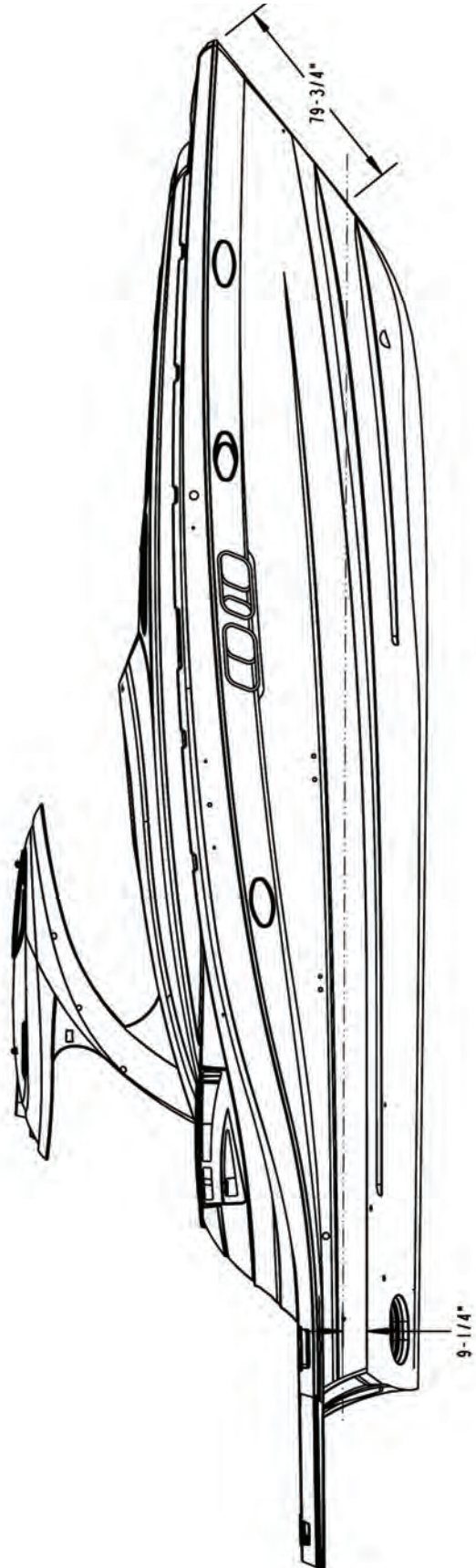
*While lifting the boat, ensure slings are in the proper locations as indicated by the sling location labels. Failure to do so may result in permanent hull structure damage and will invalidate the hull structure warranty.*

### NOTICE

*When attempting to raise the hull, never allow one end of the boat to rise first, while letting the opposite rest momentarily on the underwater gear. Serious damage to these components could result. DO NOT place lifting straps on underwater gear. Be sure the strap is against the hull surface only and are in proper location as indicated by the sling label location.*



A storage cradle designed for a larger or smaller boat will not provide proper support for the hull. This could lead to hull deformation and thus serious performance deficiencies. Four Winns offers an optional storage cradle built to properly fit your V475. Contact your Four Winns dealer for details.



**Figure P1: V475 Bottom Paint Line Location**

**Q - 1 HIGH-PRESSURE LAMINATE CARE**

Much of the V475 interior components such as the shelving, closets, closet door and drawer fronts consist of a high pressure laminate material. See Figure Q1. The finish is that of a synthetic wood and can be cleaned with hand dish washing soap and water as well as furniture polish. Always read the label before using any product.

**NOTICE**

*DO NOT use abrasive cleaners or solvents on laminate. DO NOT use Soft Scrub soap or similar cleaning products; they will scratch the surface and remove the shine.*

**Q - 2 REAL WOOD TRIM**

Four Winns uses real wood trim throughout the interior. The wood is prepared with a light stain followed by a polyurethane finish. To clean, a damp cloth or furniture polish will usually suffice. Care should be similar to that of fine, household furniture. See Figure Q1.



**Figure Q1: Real Wood Trim**

**Q - 3 STAR BOARD**

Star board is a high density polyethylene (plastic) and is very durable and fade resistant. Star board requires little maintenance, and is being used in place of wood in many areas of the boat.

To clean star board, use a solvent-free, nonabrasive cleaner such as hand dish washing soap and water. Read the label before using any cleaning product.

**NOTICE**

*Star board will stain when exposed to certain oils or chemicals. Always wipe up any spills immediately.*

**Q - 4 LAMINATED FIBERGLASS**

Certain components such as transom table option, seat bases, storage tubs, storage lids/doors, ect. may consist of a laminated fiberglass material. These components may be cleaned with mild dish washing soap and water. After washing, a light coat of wax may be applied as necessary. Always read the label before using any product. See Figure Q2.



**Figure Q2: Transom Table Option**

**Q - 5 TEAK**

Certain cockpit tables consist of teak. Also located at the port lounge is a port lounge table consisting of teak. See Figures Q3 & Q4.



**Figure Q3: Cockpit Table**



**Figure Q4: Port Lounge Table**



**Figure Q5: Galley Countertop**

Before teak can be given any coating, it must be completely clean. Follow the manufacturer's directions with regard to cleaning. Once cleaning has been accomplished there are finishes that may be applied such as teak oil (traditional), sealers, or varnishing. Again, Four Winns recommends following the table manufacturer recommendations. Additional note: There are numerous teak products on the market that may be tried that will give you the look you desire. Your Four Winns dealer can also provide you with some helpful suggestions.

**NOTICE**

*DO NOT use abrasive cleaners or solvents on cockpit table. DO NOT use Soft Scrub™ soap or similar cleaning products; they will scratch the surface and remove the shine.*

**NOTICE**

*DO NOT use tables as a cutting board. The knife will leave gouges/marks in the surface of the table. Use an actual cutting board in order to protect the tables.*



**Figure Q6: Cockpit Refreshment Center**



**Figure Q7: Port Lounge Aft Countertop**

**Q - 6 SOLID SURFACE MATERIAL**

Solid surface material is utilized in the various countertops found in the galley, cockpit refreshment center, port lounge, and heads. The solid surface gives these countertops a rich look and makes for an extremely strong yet lightweight top. It can be cleaned with hand dish washing soap and water. Always read the label before using any product. See Figures Q5 - Q9.



**Figure Q8: Aft Head Countertop**





**Figure Q9: Forward Head**

**NOTICE**

*DO NOT use abrasive cleaners or solvents on countertop. DO NOT use Soft Scrub™ soap or similar cleaning products; they will scratch the surface and remove the shine.*

**NOTICE**

*DO NOT set hot pans or dishes directly on the countertop. The countertop may become burnt and/or discolored. Use of a hot pad will prevent any discoloration from occurring.*

**NOTICE**

*DO NOT use countertop as a cutting board. The knife will leave gouges/marks in the surface of the countertop. A cutting board that fits over the sink is provided.*

## **Q - 7 Acrylic Plastic - (Plexiglass)**

Acrylic plastic is utilized in the companionway doors, transom doors, deck hatches, portlight windows, skylights, sliding storage doors, electrical panel doors, cabinets and cabin windows. See Figure Q10.



**Figure Q10: Companionway Door**

To clean acrylic plastic:

- 1) Rinse with plenty of water to wash off as much dirt as possible.
- 2) Using your bare hand, along with plenty of water, feel and remove any dried on dirt or mud. Do not use fingernails to scrape as this could scratch the plexiglass.
- 3) Wash using a soft, grit free cloth or sponge and mild, nonabrasive soap or detergent.
- 4) Blot dry using a clean, damp chamois.

**NOTICE**

*Never use a dry cloth, duster, glass cleaning solutions or citrus cleaner on acrylic plastic.*

**NOTICE**

*Do not use solvents such as acetone, silicone spray, benzine, carbon tetrachloride, fire extinguisher fluid, dry cleaning fluid, lacquer thinner or ammonia. These solutions attack the acrylic surface.*

You can use fine automotive acrylic rubbing and polishing compounds to remove fine scratches on acrylic.

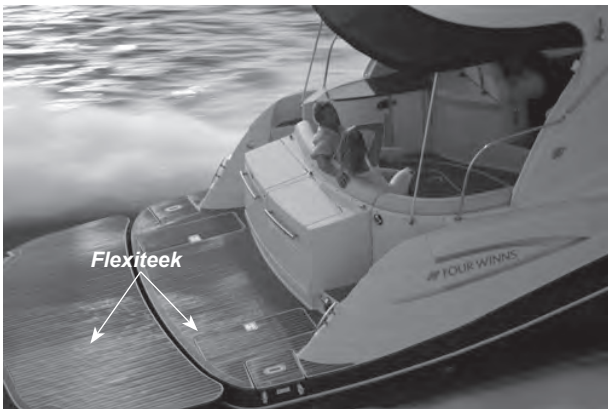


**Q - 8 FLEXITEEK**

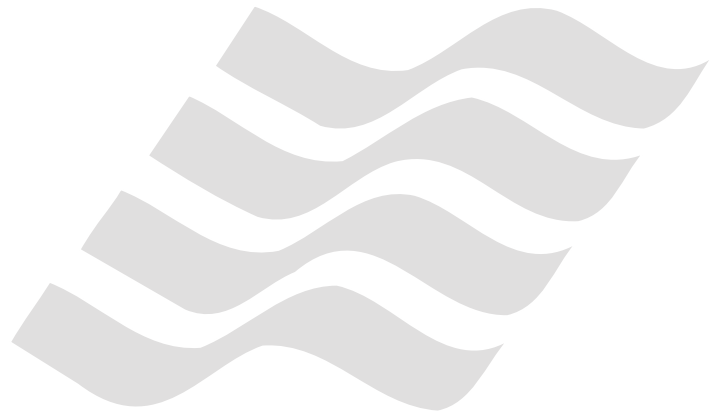
An available option is a flexiteek cockpit and/or swim platform. Flexiteek is made up of a composite PVC based material with a surprising similarity and look to that of real teak. Flexiteek can be cleaned with mild dishwashing detergent. Please contact your Four Winns dealer for further details. See Figures Q11 and Q12.



**Figure Q11: Flexiteek Cockpit**



**Figure Q12: Flexiteek Swim Platforms**



**R - 1 WINTERIZATION****A. Prior to Lifting for Winter Lay-up**

1. Pump out the head (dockside discharge), and gray water holding tank (if applicable). Be sure the holding tank(s) is empty. Flush the waste and gray water holding tanks with soap, water and a deodorizer (e.g., Lysol Liquid™). Add more water if necessary. Have the cleaning solution pumped out.
2. Have the fuel tank either full or completely empty. Ensure the fill-cap is tightly secured. See the Engine Owner's manual for recommendations. Also check with the dry dock operators for recommendations. A diesel additive may be recommended to prevent bacterial growth in the fuel.

**NOTICE**

*If the fuel has been treated with a diesel additive to prevent bacterial growth, run engines for ten minutes to make sure the treated fuel is present in all lines and parts of the engines.*

3. Drain water from the fresh water system and the hot water heater.
4. Before winterizing the engine, flush out the system according to the specific engine owner's manual. The engine flush out should be used to clean the engine of unwanted salt, mud, sludge, etc. which may have accumulated in the engine cooling system.
5. Winterize the engine and drive systems in accordance with the engine owner's manual. Portions of this winterization procedure may require that the boat be lifted. Winterization of engine and boat systems should be performed by qualified service personnel.
6. Lift the boat only at the designated "sling" labels. See Section P-7 - Hull Support and the Preface of this manual for additional details.

**B. After Lifting**

1. Remove the drain plug.
2. Thoroughly wash the fiberglass exterior, especially the hull bottom. Remove as much marine growth as possible. Wax lightly. Use extreme care if using

a high pressure washer. See engine manual for special concerns.

3. Lower boat onto cradle properly. Be sure boat is adequately supported. The boat should be raised slightly under the forward supports to improve drainage to the transom drain.
4. Be sure all the water is completely drained from the fresh water system. Disconnect all hoses, check valves, etc. and blow all the water from the system using very low air pressure. The use of nontoxic, fresh water system antifreeze is recommended as an alternative to disassembling the water system. Refer to Section J-7 - System Maintenance in this manual for information on winterizing the water system.
5. Winterize the toilets as recommended by the toilet manufacturer. The boat is equipped with a waste holding tank, mix some R.V. antifreeze solution and pour it into the head toilets. Transfer some of the antifreeze to the holding tank by flushing the toilets. Also, refer to Section J-7 - System Maintenance for additional information.
6. Winterize the optional gray water system (if applicable). Take some R.V. antifreeze solution and pour it down the various sink and shower drains. Transfer some of the antifreeze to the holding tank by pouring it down the gray water pumpout fitting.
7. Drain or winterize the air conditioning and generator system. Follow the appropriate manufacturer's directions. Be sure all water intake filters are drained thoroughly.
8. Ensure that all water is removed from the sump pump, bilge pump and bilge pump lines. Dry the hull bilge, and self-bailing cockpit drain troughs. Water freezing in these areas could cause damage. See Section K-3 - Hull Drainage Systems.
9. Remove the batteries and store in a cool place. Clean the batteries using clear, clean water. Be sure the battery has sufficient water and clean terminals. Keep the batteries charged throughout the storage period. DO NOT store the batteries on a concrete floor or other damp or conductive surface.

10. Clean the boat interior thoroughly. Vacuum carpets, and dry clean drapes and upholstery jackets as necessary.
11. Wash exterior fiberglass components, wax lightly.
12. Clean exterior upholstery with hand dish washing soap and water, rinse, and dry thoroughly.
13. Remove all oxidation from exterior hardware and apply a light film of moisture - displacing lubricant.

### C. Prior to Winter Storage

1. Remove as many cushions as possible. Remove storage lids or hatches. Open as many locker doors, as possible. Open the refrigerator door. Leave these areas open to improve ventilation.
2. Spray the weather covers and the boat upholstery with Lysol Spray Disinfectant™. Enclosed areas such as the refrigerator, shower basin, storage locker areas, etc. should also be sprayed with Lysol Disinfectant™.
3. Place small dishes of rodent poison such as D-Con™ in a number of areas around the boat. Be sure dishes are placed near the head and the engines, as rodents will destroy upholstery, water intake and discharge hoses.
4. If the boat will be in outside storage, properly support a storage cover and secure it over the boat. **DO NOT** secure the cover tightly to the boat. This does not allow adequate ventilation and can lead to dry rot. **DO NOT** store the boat in a damp storage enclosure. Excessive dampness can cause electrical problems, corrosion, and dry rot.

 **WARNING**

*Placing an electric or fuel burning heating unit in the bilge of the boat during cold weather could cause fire or explosion and is not recommended.*

5. **DO NOT** use the canvas top and canvas curtains as a winter storage cover. The life of these covers may be significantly shortened if exposed to harsh weather elements for long periods.

### NOTICE

*Boats stored outside in areas with heavy snow accumulation are more susceptible to damage, and should be inspected regularly during the winter months.*

**R - 3 GENERAL MAINTENANCE SCHEDULE**

SERVICE	AT LAUNCH AND FIRST OPERATION*	25 HOUR CHECK EACH SEASON*	BI-SEASONALLY OR EVERY 6 MONTHS OR EVERY 100 HOURS*	SEASONALLY OR EVERY 12 MONTHS OR EVERY 200 HOURS*
Engine and Instrumentation	Refer to Section E			
Engine Maintenance	As Recommended by the Manufacturer			
Inspect Exhaust System Hoses and Connections				
Inspect Cooling System Hoses, Connections and Impellers				
Check Propellers				
Check All Thru-Hull Fittings				
Gauge Cleaning				
Controls Systems	Refer to Section F			
Throttle and Shift Adjustment				
Neutral Safety Switch Test				
Cable and Control Lubrication				
Steering Systems	Refer to Section G			
Linkage and Connection Inspection				
Stern Drive Torque Tab Adjustment				
Power Steering Service	As Recommended by the Manufacturer			
Steering Adjustments				
Steering System Lubrication				
Electrical Systems	Refer to Section H			
Inspect Battery Connections				
Check Battery Water				
Battery Cable Inspection				
12 Volt Electrical Equipment Operation				
12 Volt Wiring and Connection Inspection				
120 Volt Electrical Equipment Operation				
120 Volt Wiring Inspection				
120 Volt System Continuity Test				
Shore Power Cord and Adapter Inspection				
Polarity Light Operation				
Receptacle and Connection Inspection				
Generator Maintenance (If Applicable)	As Recommended by the Manufacturer			
Inspect Generator Water Intake and Exhaust				

\* Or as Required



SERVICE	AT LAUNCH AND FIRST OPERATION*	25 HOUR CHECK EACH SEASON*	BI-SEASONALLY OR EVERY 6 MONTHS OR EVERY 100 HOURS*	SEASONALLY OR EVERY 12 MONTHS OR EVERY 200 HOURS*
Fuel System	Refer to Section I			
Inspect for Leaks				
Fuel Sender Inspection				
Fuel Filter Inspection				
Fuel Tank Inspection				
Water Systems	Refer to Section J			
Inspect All Water Systems				
Fresh, Grey & Holding Tank Inspections				
Drain & Flush Fresh Water System				
Drain & Flush Waste Water System				
Drain & Flush Grey Water System				
Ventilation and Drainage	Refer to Section K			
Engine Blower Operation	Before Every Use			
Head Blower Operation				
Blower Vent System Cleaning				
Bilge Pump Operation and Cleaning	Before Every Use			
Check Transom Drain Plug				
Deck Hatch, Porthole & Aft Window Cabin Operation				
Interior Equipment	Refer to Section L			
Air Conditioner	As Recommended by the Manufacturer			
Head Maintenance	As Recommended by the Manufacturer			
Thru-Hull Fitting Inspection				
Icemaker and Refrigerator Cleaning				
Clean Cooler	As Required			
Inspect Stove Fuel System (If Applicable)				
Stove Maintenance	As Recommended by the Manufacturer			
Exterior Equipment	Refer to Section M			
Check PFD's for Serviceability and Correct Number	As Required			
Check Charge of Fire Extinguishers	As Required			
Clean Spotlight				
Check Compass for Magnetic Deviation				
Windlass Maintenance (If Applicable)	As Recommended by the Manufacturer			
Check Trim Tab Fluid Level				
Check Trim Tab System for Leakage				

\* Or as Required



**S - 1 LAUNCH AND CRUISE CHECKLIST**

- Get a current weather report. If the weather will not be favorable, postpone your trip.
- If your boat has been out of the water, check to see that all bilge water has drained out.
- Install hull drain plugs.
- Inspect the hull and propeller for damage. Excessive dirt or marine growth will effect your boat's performance and fuel efficiency.
- Check the electrical system and navigation lights.
- If your boat has been in the water, run the bilge pump until the flow of water stops.
- Check that all required safety equipment is on board and in good working condition. Examples include personal flotation devices (PFDs), horn, fire extinguisher, visual distress signals, etc. Take along extra drinking water.
- Check that other important equipment is on board. Examples include mooring lines, anchor and line, tool kit, first aid kit, etc.
- Open engine compartment. Inspect for fuel odors and visible leaks in the fuel, oil, coolant, exhaust and power steering systems.
- Visually inspect engine for cracked hose, defective belts, or other signs of engine problems. Check engine oil and battery water levels. Check power steering fluid level. Check battery electrolyte range.
- Check fuel level. Fuel tanks should be filled to slightly less than capacity. Allow for fuel expansion.
- Check that all engine drains are closed (stern drives).
- Make sure navigation charts and equipment are on board.
- Check operation of steering system, navigation lights, and operation of horn.
- Make sure passengers and crew know what to do in case of an emergency and how to operate safety equipment.
- Make sure all required documents are on board.
- File a float plan with a responsible party ashore.
- Keep an eye on the weather. Be aware of possible changing conditions by monitoring local weather broadcasts prior to departure. The captain or first mate should personally monitor strong winds and electrical storms.
- Always keep accurate up-to-date charts of your boating area on board.

## S - 2 FUELING



*Do not smoke, extinguish all open flames, STOP all engines and other devices that could cause sparks, including the bilge blower. Do not use electrical switches or accessories. Shut OFF all stoves that may produce a spark or flame. Close all openings into the cabin area of the boat.*

### A. Recommendations



*When fueling or having your boat fueled by an attendant, be sure the waste pump-out or fresh water fitting is not mistaken for the fuel fill.*

The fuel system components used by Four Winns® will withstand up to 10% alcohol content in the gasoline (not applicable to diesel engines). Although alcohol boosts the octane level of gasoline, it also attacks the rubber fuel distribution lines and even metal fuel system components. Alcohol will permeate most fuel hoses and other components such as fuel pump, gaskets and seals, and can also contribute to fuel system contamination.

The hoses we use in our boats are alcohol-resistant as are the materials used by the engine manufacturers. If only fuel containing alcohol is available, or the presence of alcohol is unknown, you must perform more frequent inspections for leaks and abnormalities. Any sign of leakage or deterioration requires your immediate attention. Refer to the engine manufacturer's recommendations on fuel type and octane ratings.

### B. Preliminary Guidelines

1. Safely secure your boat to the dock.
2. Close all hatches, windows, doors and compartments to prevent accumulation of fuel vapors.
3. Ensure that a fire extinguisher is readily available.
4. Do not store fuel in areas that are not adequately ventilated.
5. Use only fuel lubricants recommended by the engine manufacturer.

## C. Pumping Fuel



*Follow engine manufacturer's recommendations for types of fuel and oil. Use of improper products can damage the engine and void the warranty.*

1. Be sure to fuel in a well-lit area. Fuel spills are unnoticeable under poor lighting or in the dark.
2. Remove the fuel fill cover.
3. Insert the fuel supply nozzle, keeping it in contact with the fuel fill plate to guard against static produced sparks.
4. Stand away from the fuel tank vent and gas fill during fueling. Splash back may occur and can be an eye irritant and/or a fire hazard.
5. Avoid spillage. Wipe up any excess fuel immediately.
6. After pumping approximately 10 gallons of fuel into the fuel tank, inspect the engine and fuel tank area for any signs of leakage. If no leaks or other problems are detected, resume fueling.
7. Allow space at the top of the tank for thermal expansion.
8. If fuel cannot be pumped in at a reasonable rate, check for fuel vent blockage or a kink in the line.

### D. After Fueling

1. Replace the fuel fill cover and wipe up any fuel spilled. Discard rags used in a safe place ashore.
2. Open the engine compartment and all hatches, windows, doors and other compartments that were closed during fueling. Inspect these areas for the odor of fuel vapors and visible fuel leakage.



*Investigate and correct any sign of fuel leakage or indication of vapors before starting engine. Do not run blower or operate any electrical switch until problem is corrected. Fire or explosion may result.*



### S - 3 LOADING PASSENGERS AND GEAR

When loading your boat, remember to distribute the load evenly. Keep the load low and do not overload. Position passengers and gear so that the load is balanced.

#### NOTICE

*The NMMA Yacht Certification rating (indicated by a yacht certification plate - see Preface page 14) places the responsibility on the captain to make the determination as to the appropriate load, load placement and number of passengers permitted aboard the vessel.*

When loading, always step into the boat, never board by jumping. Have someone on the dock pass your gear aboard. Secure all gear firmly so it doesn't move or interfere with operation of the boat. Passengers should board the boat one-at-a-time and be seated.

**IMPORTANT:** Passengers are prohibited from riding on the bow with feet hanging over the side or ride while sitting on the stern, gunwales or seat backs. The Coast Guard considers these acts to be negligent or grossly negligent operation. They are prohibited by law because falls from moving boats are a major cause of fatal recreational boating accidents.

**IMPORTANT:** The presence of the capacity plate does not relieve the boat operator from the responsibility of using common sense or sound judgment. Turbulent waters and adverse weather conditions will reduce the maximum load capacity rating of the boat.

### S - 4 STARTING PROCEDURES

The operation and maintenance manual supplied with your engine provides pre-start, starting and cold-starting instructions. The following information is merely a guide and not intended to explain in detail all starting procedures and instructions. Refer to your engine owner's manual and Section A of this manual..

#### A. Preliminary Checks

1. Secure boat to the dock before attempting to start engine. The boat should be kept secure until the engine is running and warmed up.
2. Operate the bilge pump until the flow of water stops.
3. Make sure the throttle is in the neutral position.

#### B. Starting



*To prevent excessive exposure and reduce the possibility of carbon monoxide accumulation in the cockpit areas of the boat, the operator should provide adequate ventilation in each of these areas. Utilize hatches, doors, windows and side vents to increase air movement. See Section B-2 for information about the dangers of Carbon Monoxide.*

**Notice:** Additional starting information is located in Section A.

1. Activate the batteries by placing the switches on the 12VDC cabin panel to the ON position. Place the Helm Main circuit breakers to the ON position. Check all electrical systems and navigation lights.
2. Activate the Bilge Blower. Check the blower output.



*Fuel vapors can explode resulting in injury or death. Before starting the engine, check engine compartment bilge for fuel or vapors. Operate blower for four minutes, and verify blower operation. ALWAYS run the blower when the vessel is operating below cruising speed.*

3. Open the seawater seacocks on the drive units.
4. Turn the ignition key to the ON position "I" and wait 20 seconds, allowing pre-heaters to activate.

5. Check for audible warnings, information messages or alarms on EVC system displays.
6. Activate the control position by pressing the EVC control panel activation button for at least one second. When the button is released, the indication button lights up to confirm that the control position is activated.
7. After 20 seconds, turn key switch to START position and hold until engine starts. DO NOT hold in START position for more than ten seconds. If one of the designated engine batteries fails to start its respective engine, engage the "EMERGENCY START" switch at the helm and attempt to start the engine.
8. As soon as engine starts, release key to the ON or RUN position.
9. Once engine has warmed up, check water temperature to ensure engine temperature stays within optimum range. If temperature reading is abnormally high, stop engine immediately and inspect for cause of high reading.
10. Inspect for fuel odors and visible leaks in the fuel, oil, coolant and exhaust.
11. Make sure boat is securely moored to the dock and engine is idling. Then move the throttle forward and then aft and back to neutral to check for proper operation of the shifting motion. Be careful. Leave the engine in gear for only a second or two.

## S - 5 MANEUVERING

When all your pre-departure checks have been completed and the engine has warmed up, you will be ready to leave the dock. Take into account the amount of wind, tide current, and other forces that may affect your maneuvering as you leave the dock. Idle speeds work best when maneuvering to and from the dock. Do not forget to release the mooring lines.

### A. Leaving the Dock

You are ready to leave the dock after the engine has warmed up. Check all EVC displays for appropriate readings before casting off. If oil pressure is abnormally low or engine temperature is abnormally high, stop the engine immediately. Check voltmeter to be sure the charging system is working properly. Check for fuel, oil, and exhaust leaks. Correct the cause of any abnormal condition before getting underway.



*To prevent personal injury, swim platform must not be occupied and transom door must be closed while engines are running.*

After making sure your boat is ready, check wind, tide, current and other forces that will affect the way you maneuver your boat away from the dock. Throw mooring lines off to your boat. Shift your boat's engine into forward or reverse depending on whether you want to move the bow or the stern away from the dock first. Run your engine at a slow speed as you move away from the dock. If you move the bow out first, watch that the stern of the boat does not swing into the dock or a piling.

Once away from the dock, devote some time to learning how to maneuver. Practice docking using an imaginary dock. Practice stopping and reversing.

### B. Stopping

Boats have no brakes. Stopping is accomplished by backing down on the throttle. Practice stopping maneuvers and learn early how your boat reacts. From forward motion, pull the throttle back towards NEUTRAL. Depending on your speed, the distance the boat travels until it comes to a complete stop will vary. The ability to measure the distance will only be acquired through experience.

Once the boat has slowed and motor is idling, place the shift in REVERSE. Gradually increasing reverse power with the throttle will allow you to stop the boat in a very short distance.

**NOTE:** A boat will not respond to steering in reverse nearly as well as it does when going forward, so do not expect to accomplish tight turning maneuvers when backing up.

Remember that all boats steer by the stern (the feeling is much like steering your automobile in reverse). This means that the stern of your boat will swing in the direction opposite to your turn. For example, when you turn the helm wheel to the left, the stern of your boat will swing in the direction opposite to your turn. This is especially important to keep in mind when docking, operating in close quarters with other boats, or when approaching a swimmer or downed skier in the water.

Always look behind you and to both sides of the boat before slowing down. Tell your passengers your intentions to allow them time to make adjustments to their balance or positions.

Slowly pull back on throttles, glance back and see if a large following wave is approaching the transom. If so give the engines a little throttle as the wave arrives to keep wave from rolling over the transom.

Once you have spent enough time practicing maneuvers and have a feel for how the boat handles, you will be ready to run in open waters.

## S - 6 ACCELERATION



*Before accelerating to bring your boat on plane, be sure that the area in front of your boat is clear. The bow will rise out of the water momentarily before you plane and may temporarily obstruct your vision.*

If you have never had your boat on plane before, choose a calm day for your first on plane experience. Never boat beyond your ability and experience.

Before bringing your boat “on plane”, check the entire area to make sure you have a clear, safe path. As you throttle up to accelerate, your boat will increase its angle of trim, causing the bow to ride high. From a maximum angle, the boat will level out to its planing attitude with continued acceleration. This maximum angle is known as the “hump”. Because visibility, handling, and performance are reduced, it is advisable to get “over the hump” as soon as possible. A few seconds at full throttle should get the boat over the hump and into its planing attitude.

After getting over the hump, accelerate until reaching a comfortable plane, then throttle down to cruising speed. This also will provide for better fuel efficiency.

## S - 7 TRIMMING YOUR BOAT

Trim tabs are used to add lift to the boat’s stern, thereby changing the boat’s attitude. This lift can help the boat get on plane faster and remain on plane at slower speeds than if no tabs were used. Used independently, tabs can also correct listing conditions caused by crosswinds, unbalanced loading and quartering seas.

Before accelerating and trying to gain plane, press upper button. This will cause both trim tab blades to lower in parallel and force the bow down when running. This can also be used when running the boat with a heavy load aboard.

Moving the trim tab blades downward will increase the lift and the boat will achieve plane faster, or stay on plane at a lower engine and boat speed.

After gaining plane and establishing cruising speed, pressing the lower button retracts the blades in parallel and will allow the bow to rise. This should be used to adjust the running attitude of the boat to decrease the drag at cruising speed or above, or when running in a following sea.

When running at an engine speed that results in the boat falling off plane or causes the boat to plane inefficiently, lowering the blades slightly (bow down) will improve the running angle and improve operating efficiency.

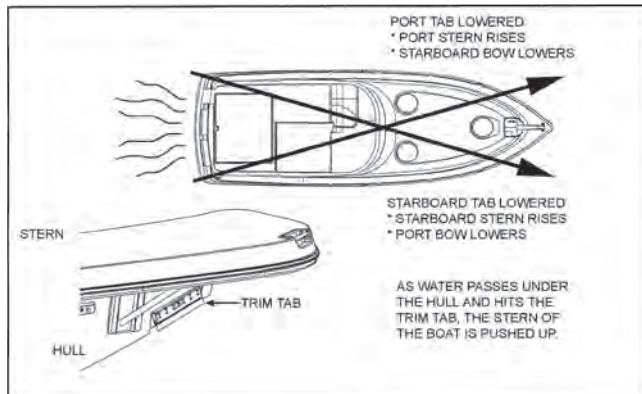
Optimum efficiency is obtained when operating at a 3 to 5 degree running angle. Utilizing too much “Bow Down” trim tab can reduce operating efficiency and cause substantial steering and handling difficulties. Be extremely careful when running in a following sea. The effect of trim tabs is amplified under such conditions. Steering and handling difficulties can result from improper trim tab usage, especially in a following sea. If unsure of proper trim tab positioning, raise the trim tabs to the full-up position.

Trim your boat to compensate for seas, winds, or uneven loads.

Head Seas	Trim drives in more than usual. Use tabs to keep bow down and go at a slower speed.
Following Seas	To prevent taking seawater  The bow, trim drives out and keep tabs up to keep bow down
Listing Due to Quartering Seas, Beam Wind, or Uneven Load	Use tabs independently to adjust for list. If listing to starboard, press port bow down switch. If listing to port, press starboard bow down switch.

Remember that most boats react very slowly to trim tabs. Often boat owners do not give trim tabs time to work. Press the trim tab switches for only one second at a time and then allow some time for the boat to react. If the boat is still listing after a minute or two, press the trim tab switch again for a one second interval. The labels on the trim tab switches indicate what you want your boat to do, not what you want the tabs to do.

It is a good idea to take your boat out onto open water shortly after you get it and experiment with the trim tabs. After you get your boat onto plane, set the tabs in various positions and note how your boat reacts. This will give you a feel for how the trim tabs work.



**Figure S1: Trimming the Boat with Trim Tabs**

## S - 8 NAVIGATION LIGHTS

Although night activities are limited, cruising at night can be very pleasurable. It can also be dangerous if you don't pay close attention to water levels and obstacles. Be especially careful of shallow waters and watch for submerged debris, rocks and other obstacles in the water. Your navigation lights are intended only to prevent collision, not to improve your night vision. You may choose to use a spotlight instead.

**NOTE:** It is illegal to use your spotlight as a headlight. Use it only temporarily to check the position of your boat and the surrounding area.

Depending on your model, the boat has one white (stern or mast light), one red (port) and one green (starboard) light. The stern light may be a removable pole light. To use the light, line up the two-prong plug in the pole with the receptacle in the base. Plug the light in, and lock it into place with lever/slide lock. When not in use, stow the light inside your boat for safekeeping. This light can be turned on or off at the helm.

Check lights for proper operation before heading out at night. You should also learn to identify the running light combinations for other vessels. We recommend that you participate in a boating safety course to further learn about navigation lights and safe boating practices.

The anchor lights and navigation lights are controlled by a switch at the helm. The anchor light switch allows you to turn on just the stern (white) light when anchored or moored. While underway, use the navigation light switch to turn on the stern or mast light (white), port (red) and starboard (green) lights. Lights are off when switches are in the OFF position.

## S - 9 HAZARDOUS CONDITIONS

### A. Storms

Storms sometimes appear without advance notice. Although weather information from meteorological observation and reporting stations is available, weather bureaus are known to have failures in their predictions or information gathering equipment. There is no substitute for a strong understanding of what action to take when the weather takes a turn for the worse. Many marinas fly weather signals. You should learn to recognize these signals and monitor your local weather forecasts before leaving port.



The present and forecasted weather conditions are of primary consideration, but a threat of possible storms should always be a concern. Observance of the following information will help in your safety afloat if storms do occur:

- Keep a watch on the horizon for approaching storm indicators.
- Turn radio ON. Dial in local weather station and monitor forecast. If your boat has a VHF radio, check the weather channels.
- The best possible situation is to return to a safe port if time allows.
- Close and secure all portals and hatches. Stow all loose gear below deck and tie down any gear required to remain on deck.
- Reduce speed as the seas build. Make sure all passengers are wearing their PFDs.
- If you lose power, keep the boat headed into the waves by rigging a sea anchor off the bow. If there is no sea anchor on board, use a canvas bucket or any object that will offer resistance.
- Radar reflectors (if installed on your boat) should be 18 inches diagonally and placed 12 feet above the waterline.

## B. Fog

Fog is a result of either warm surface or cold surface conditions. You can judge the likelihood of fog formation by periodically measuring the air temperature and dew point temperature. If the spread (difference) between these two temperatures is small, you likely will incur a fog situation. Remember the following guidelines:

- Turn on running lights.
- As fog sets in, take bearings and mark your position on the chart while continuing to log your course and speed.
- Make sure all persons aboard are wearing their PFDs.
- If your boat has depth finding equipment, take soundings and match them with soundings on your charts.

- Station a person forward on the boat as a lookout.
- Reduce your speed. From time to time, stop engine and listen for fog signals.
- Sound the proper horn or fog bell at proper intervals to warn other boaters.
- If there is any doubt in continuing boat movement, anchor. Listen for other fog signals while continuing to sound the proper fog horn or bell for a boat at anchor.

## C. Running Aground



*To prevent boat damage, DO NOT use deck hardware or water ski pylon for towing. Use a commercial towing service.*

Operating in shallow water can present a number of hazards. Sand bars in narrow inlets are constantly shifting, making it difficult to mark them with buoys. Sometimes sand bars are indicated by waves as they form into breakers when passing over sand bars. In coastal areas, tides can change water levels by as much as 30 feet. Check with local marinas or Coast Guard stations for tide tables and current charts.

If your boat runs aground, first check persons aboard for injury. Then check for damage to the boat. If the drive unit strikes an underwater hazard, check for boat and drive unit damage. If the engine vibrates excessively after striking an underwater obstruction, it may indicate a damaged propeller. If vibration is noticeable, return to port slowly to prevent further drive and engine damage from an out-of-balance condition. Watch the temperature gauge to make sure you do not overheat the engine.

If the boat is not taking on any water, it may be possible to rock the boat by shifting the weight of the passengers and gear and by raising the drive unit while reversing the engine.

If you ground your boat on a sand bar, shut down the engines and seek help from another boater or radio for help. See your dealer as soon as possible, as sand ingested in the engine cooling system can cause major engine damage.

#### D. Warning Markers

It is a good idea to find out about hazardous areas and how they are marked by asking your local authorities.

- Boaters must also recognize the flag designs which indicate that scuba divers are present and keep well clear of the area.
- Watch for swimmers. Swimming areas may not be marked. Steer clear from the area and always remain alert.
- Distress flags indicate a fellow boater is in need of assistance.
- Navigation markers serve as a means of identifying navigable routes and indicate water hazards. Boaters should become familiar with navigation markers and stay within marked boundaries and clear of hazards.

### S - 10 REACTING TO EMERGENCIES

Be prepared to deal with emergencies before they happen. Try to formulate a plan for each type of emergency in advance so that decisions can be made quickly and without hesitation. Precious moments lost can mean the difference between losing and saving a life.

#### A. Flooding

If your boat starts taking on water, activate the bilge pump immediately. Make sure all passengers are wearing their PFDs. Open the engine compartment, look for the cause of the flooding. Check all hoses, through hull fittings, seacocks and strainers. If flooding occurs as a result of collision or grounding damage, call for assistance and head for shore if possible.

#### B. Capsizing and Man Overboard

By far, the largest number of boating fatalities involve capsizing and falling overboard accidents. By being prepared ahead of time with an appropriate plan of action, you can greatly lower your chances and your passengers' chances of becoming seriously injured.

#### C. Capsizing

Wear PFDs or have them readily available at all times. If your boat capsizes, and others were on board, locate them and guide them to the safety of the hull. Even if the boat floats in an upside-down position, stay with it. The boat hull is much easier for rescuers to spot than a human head sticking out of the water. DO NOT attempt to swim ashore, it may be further than it looks.

#### D. Man Overboard

Think through and follow these procedures if someone in your boat falls overboard.

- Remember, every second counts, you must act fast.
- Move throttles to idle position immediately and yell "MAN OVERBOARD."
- Throw some floating object overboard immediately. Keep your required Type IV PFD accessible at all times for such an emergency.
- Keep the person in the water in sight at all times. Have a passenger do nothing but watch the person. Do not go into the water to help the victim. One person in the water is enough trouble.
- Circle around quickly, approaching into the wind and waves. When the person is alongside, put the engine in neutral and throw them a Type IV PFD with a line attached or extend a paddle or boat hook within his/her reach.

#### E. Collision

If a serious collision occurs, you should first check the condition of all passengers aboard, then inspect your boat to determine the extent of damage.

1. Make sure all persons aboard are wearing their PFDs.
2. If you need help and your boat has a ship-to-shore radio, first contact the U. S. Coast Guard (VHF Channel 16) or other rescue authorities immediately.
3. Prepare to assist the other vessel unless your passengers and/or boat are in danger.

4. If the bow of the other boat penetrated your boat's hull, prepare to block the opening once the boats are separated.
5. Shore up the hole with a spare PFD or bunk cushion from your boat.
6. While blocking the hole, trim the boat so that the hole is out of the water.

## F. Fire

Most fires are caused by electrical problems or careless fueling practices. A fire on board your boat is a serious emergency. You must work quickly to implement safety procedures. If a fire occurs, immediately stop the engine.

1. Make sure all persons aboard are wearing their PFDs.
2. If the fire is small, attempt to put it out with your fire extinguisher. If the fire is in the engine compartment, turn off the bilge blower. Do not open the engine compartment. This feeds oxygen to the fire and may cause it to flare up.
3. If the fire gets out of control, execute a distress signal and call for help if equipped with a ship-to-shore radio.
4. All persons aboard should jump overboard and swim a safe distance away from the flames.

**IMPORTANT:** All persons aboard should know the location and proper operation of the fire extinguishers.

### Guidelines

- Use only approved marine cooking and heating systems.
- Open flames demand constant attention.
- Keep flammable materials in approved containers in an overboard vented locker sealed from the interior of the boat.
- Ensure ventilation systems are unobstructed.
- Remove mooring covers before starting engine.
- Check the bilge for fuel leaks.

- Extinguish smoking materials carefully.
- Use special care with flame or high temperatures around urethane foam.
- Check cleaning products for flammability.
- Ventilate when cleaning or painting.
- Disconnect electrical system from its power source before performing maintenance.
- Replace breaker or fuse with same amperage device.
- Electrical appliances must be within rated amperage of boat circuits. Observe the boat carefully while the electrical system is being energized.
- Allow only a qualified marine electrician to service the boat's electrical system.

## G. Medical Emergency

Accidents while boating can and may happen. Be prepared to handle these emergencies when they happen. Keeping a first aid kit and dry blankets on board can assist during these situations. It is also a good idea to contact your local Red Cross for information and training on first aid and CPR.

## H. Propulsion Failure

Before you call for help regarding an engine or drive unit failure, it is a good idea to eliminate the possibility of simple problems. Turn off the engine and check to see that (1) there is fuel in the tank; (2) the engine cooling intakes on the drive are not clogged; (3) props are clean and free of weeds, netting, etc. ; (4) no hoses are leaking; (5) there is oil in the engine.

Once you have checked out the possibilities listed above and find they are not the problem, call for help giving your position and a detailed description of your boat.

## I. Control Failure

**Note:** Refer to your engine manual for specific information regarding control failure. The Emergency shifting procedure is taken directly from the engine manual.

In the unlikely event of a shift/throttle failure, observe the fault displays on the EVS displays. Acknowledge

the alarm and take the recommended measures referred to in “Fault Register” chapter of the engine manual. It may be advisable to shut down the engines on both sides and try to restart them again. If error remains after restart have the boat towed to an authorized service facility. Should emergency shifting become necessary see the following Emergency Shifting procedure.

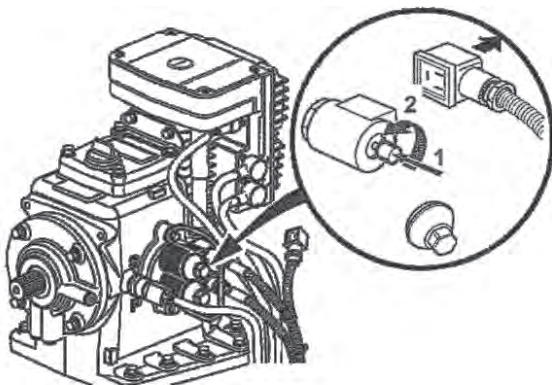
Emergency Shifting procedure:



*In emergency shifting, the unit is locked in forwards operation. Please note that the gear can not then be disengaged with the control lever. Forward motion can only be cut off by stopping the engine with the ignition key or stop button.*

**Note:** This description is for manual engagement of the drive-unit, for forward travel. Refer to Figure S2.

1. Stop the engine and remove the start key from the key switch.
2. Note the valve to which the cable marked “Primary” (lower solenoid) is connected. Then undo both connectors from the solenoid valves.  
**NOTE! P is forward and S is backward.**
3. Remove the cap nut from the valve which was connected to the “Primary” cable.
4. Press the valve (1) while turning (2) the button a 1/2 turn **counter-clockwise** (the button is forced out by spring action). The drive-unit is now connected for forward motion and cannot be disengaged by the control lever.



**Figure S2: Emergency Shift Procedure**

## J. Steering Failure

**Note:** Refer to your engine manual for specific information regarding steering failure.

If a problem with the steering occurs, observe the fault displays on the EVS displays. Acknowledge the alarm and take the recommended measures referred to in the “Fault Register” chapter of the engine manual. Shut down the engines immediately and restart. If error remains after restart have the boat towed to an authorized service facility.

If the steering is not operating properly, do not operate the boat and call for assistance. In the extreme circumstance that the boat had to be steered, it could be done using control levers. See the engine manual for details. Also, refer to the section called “Alignment of the Drive-unit” in the engine manual under the “In Case of Emergency” chapter in order to place the drive-unit straight forward without using the steering wheel.

## K. Additional Underway Information

- Always be aware of local laws on noise limits. Noise means engine noise, radio noise or even yelling by people on your boat. Good seamanship demands that you operate your boat quietly so as not to infringe on the rights of others. Don't use thru-transom exhaust unless you are well off shore.
- You are responsible for any damage or injury caused by your boat's wake. Observe no wake speed zone warnings. Operate your boat with regard for the safety of other boats and people in your boating area.
- Keep your engine well tuned to decrease exhaust hydrocarbon emissions that pollute the air and water.

## S - 11 RETURNING TO SHORE

### A. Docking

Always approach the dock slowly. Think before acting. If you are wondering whether your boat will fit in a space against a dock, remember that pilings are often (but not always) spaced 10 feet apart.



Remember that it is easier to control a boat in reverse because a boat steers from the stern. When backing into a slip, back so that bow swings into the wind if possible. You will have more control.

If possible, come in against the wind or current, whichever is stronger. Approach the dock at a 30-45° angle. As the boat nears the dock, slowly swing parallel to it. Tie the bow line first; then the stern.

If wind or current is moving toward the dock, move parallel to the dock further out. Let the wind or current push you in. Tie the stern first, then the bow.

Use extreme caution if wind or current is from your stern. Back in towards the dock slowly at a slight angle with engine in slow reverse. Gently swing parallel. Tie stern first, then the bow.

If the weather looks bad, use spring-lines from the bow and stern to dock amidships of the boat. Tie up on the downwind side of the dock. If the wind is changeable, place fenders over the side between the boat and the dock.

## B. Mooring

After you have positioned your boat next to the dock, you must secure it with mooring lines to keep it in position. Mooring lines must be long enough to secure your boat in any docking situation.

For example, dock lines should be at least 2/3 of the length of your boat and the spring lines should be at least the full length of your boat. The size (diameter) of your line depends on the size and weight of your boat. The following is an approximate guide. See your Four Winns dealer for recommendations.

	Line Diameter
Boats under 20 feet =	3/8"
Boats 20 to 30 feet =	1/2"
Boats 30 to 40 feet =	5/8"
Boats 40 to 60 feet =	3/4"
Boats over 60 feet =	1"

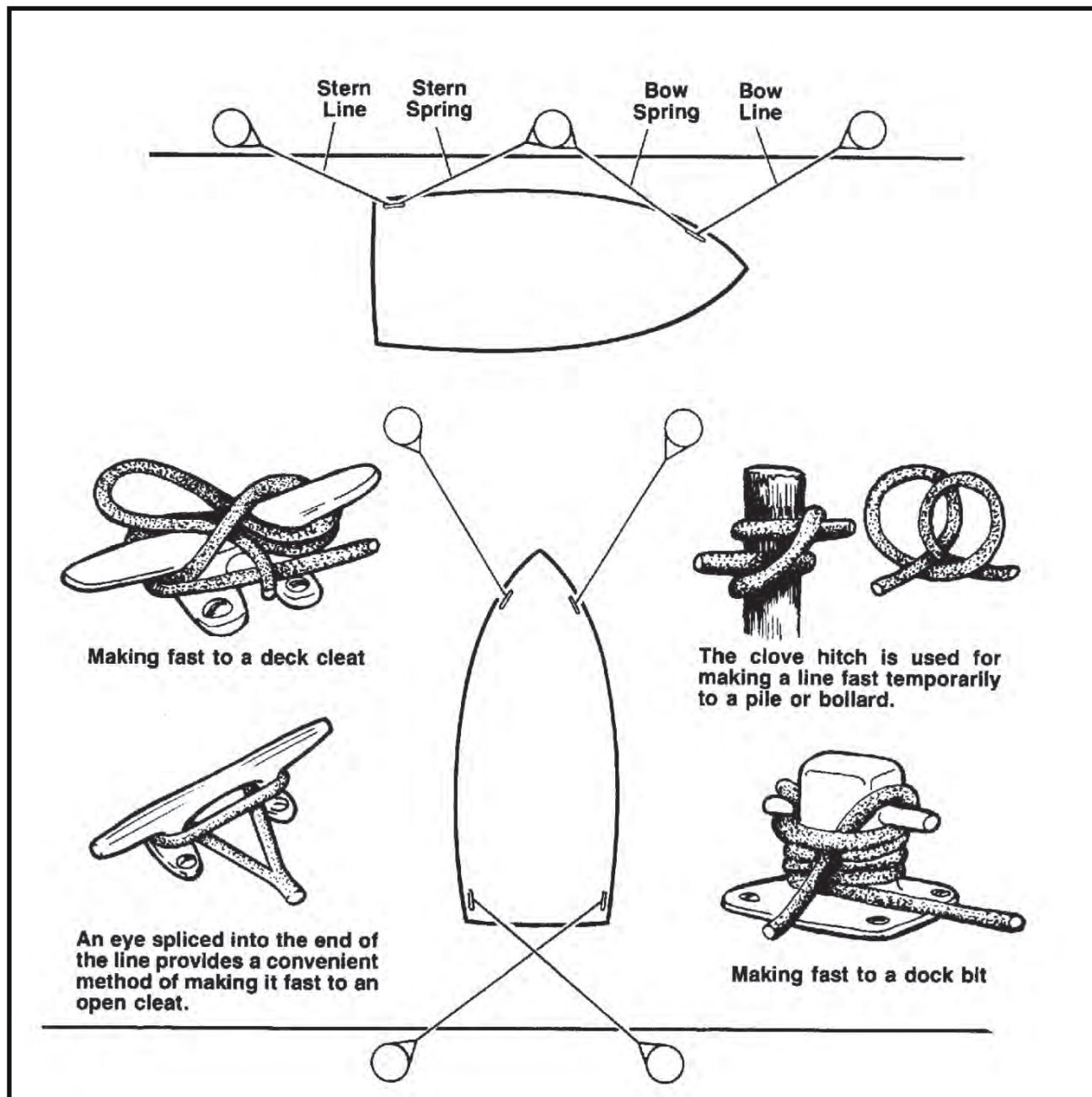
**Note:** If your boat is heavy for its size, consider going up one size in diameter.

An eye splice at the end of each line works well with bow or stern cleats.

The mooring lines you will use most often are the bow line, the stern line, and spring lines as shown on Figure S3. Each line has a specific purpose. The bow line and the stern line secure your boat's bow and stern. The two spring lines keep your boat from moving forward or backward when you are moored alongside a dock.

If you are mooring your boat for a short time, bow and stern lines may be the only lines you will need. If you are mooring your boat for a longer time or the currents are swift, you should use spring lines. The stern spring line leads from the boat's stern cleat forward to the piling or cleat on the dock. The bow spring line leads from the bow cleat aft to the dock.

If you are mooring your boat in a slip, bow and spring lines, port and starboard, will keep your boat in position.



*Figure S3: Mooring Lines*

**ABAFT** - Toward the rear of a boat.

**ABEAM** - At right angles to the keel of the boat.

**ABOARD** - On the boat.

**ABREAST** - Side by side.

**ADRIFT** - Loose, not on moorings or towline.

**AFT** - Moving toward the stern, you are going aft.

**AGROUND** - Stuck fast to the bottom.

**AHEAD** - In a forward direction.

**ALEE** - Away from the direction of the wind; opposite of windward.

**ALOFT** - Above the deck.

**AMIDSHIPS** - 1. An object or area midway between the bow and stern. 2. An object or area midway between the port side and the starboard side of a vessel.

**AMPERE** - The standard unit used to measure the draw of an electrical current.

**ANCHOR RODE OR ROPE** - The line (chain) connecting a vessel to its anchor.

**ANCHOR BALL** - A black, circular, day signal hoisted to show that a vessel is anchored. Replaced at dusk by the anchor light.

**ASTERN** - Anywhere behind the boat, a reverse direction, opposite of ahead.

**ATHWARTSHIPS** - A line, or anything else, running perpendicular to the fore-and-aft center line of a boat.

**BATTEN** - A strip of wood or metal used to secure tarpaulin(s) in place over a hatch. To batten down means to secure for rough weather.

**BEAM** - 1. The widest distance across a boat from the outside skin on one side to the outside skin on the other. 2. A transverse structural member that stiffens and supports a portion of the deck.

**BEAM WIND** - A wind blowing against the side of the vessel, perpendicular to the long axis of the vessel.

**BILGE** - The lowest interior area of a hull, used to collect water that has entered.

**BILGE PUMP** - A pump intended for removal of spray, rainwater, and the normal accumulation of water due to seepage and spillage; not intended for damage control.

**BINNACLE** - The stand or support for a magnetic compass occasionally used to mean helm.

**BITT** - A heavy and firmly mounted piece of wood or metal used for securing lines.

**BLOCK** - A wooden or metal case enclosing one or more pulleys and having a hook, eye, or strap by which it may be attached.

**BOLLARD** - A single post (wood, metal, or concrete) on a dock, pier, or wharf used to secure a vessel's lines.

**BONDING** - The electrical connection of exposed metallic, non-current carrying components to a common point on the main engine block.

**BOW** - The front end of the boat.

**BOW LINE** - A docking line leading from the bow.

**BREAKER** - A single breaking, plunging or spilling wave.

**BREAKER LINE** - The outer limit of the surf. However, all breakers may not be in a line. They can occur outside the breaker line.

**BRIDGE** - The main vessel control station.

**BROACH** - The turning of a boat parallel to the waves, subjecting it to possible capsizing.

**BULKHEADS** - The interior walls of a boat.

**BULWARK** - The side of a vessel when carried above the level of the deck.

**BUOY** - An anchored float used for marking a position on the water, a hazard, or a shoal.

**CAPSIZE** - To turn over.

**CAPSTAN** - A machine that moves a cylindrical device on a shaft for the purpose of hauling up an anchor.

**CAST OFF** - To let go.

**CATAMARAN** - A twin-hulled boat, with the hulls being side-by-side.

**CHINE** - The intersection of a boat's bottom and side. If this intersection is rounded, it is a "soft" chine. If the intersection is squared off, it is a "hard" chine.

**CHOCK** - 1. A fitting or hole in a railing or deck through which a mooring or anchor line is routed.  
2. A wedge used to secure an item in place.

**CIRCUIT BREAKER** - A device used to interrupt an electrical circuit when current flow exceeds a predetermined level.

**CLEAT** - A double-ended deck fitting to which lines are secured; usually anvil-shaped.

**COAMINGS** - Raised lips around cockpits or hatches used to keep water from entering

**COCKPIT** - An exposed deck area (usually aft) that is substantially lower than the adjacent deck.

**COMBER** - A wave on the point of breaking. A comber has a thin line of white water on its crest, known as "feathering."

**COMPANIONWAY** - The steps or ladder leading downward from a deck.

**COMPARTMENTS** - Rooms divided by bulkheads.

**COUNTER** - The overhang at the stern of a boat.

**CRADLE** - A framework, generally made of wood, used to support a boat when it is out of the water.

**CREST** - The top of a wave, breaker or swell.

**CUDDY** - A small sheltered cabin in a boat.

**CURRENT** - 1. The movement of water,  
2. The flow of electrical charge.

**DEAD AHEAD** - Directly in front of the boat.

**DEAD RECKONING** - A plot of courses steered and distances traveled through the water.

**DECK** - A permanent covering over a compartment, hull or any part thereof.

**DESIGNATOR** - Model identifier or model name.

1. to mark or point out; indicate; show; specify.
2. to denote; indicate; signify.
3. to name; entitle; style.

**DINGHY** - A small, open boat used for ship to shore transportation.

**DISPLACEMENT** - The weight of water displaced by the hull of a vessel.

**DISPLACEMENT HULL** - A hull that "displaces" a volume of water equal to the weight of the boat. A hull designed to run in the water rather than on top of the water. When a displacement hull moves through the water, it pushes that water out of the way. Water will then flow around the hull and fill the "hole" the boat leaves astern.

**DOCUMENTED VESSEL** - Documented yachts have been specially registered with the U.S. Coast Guard. All documented yachts must have their name and home (hailing) port marked on some conspicuous place on the hull. Numbering is not required. Advantages include legal authority to fly the yacht ensign, privilege of recording bills of sale, and other instruments of title with federal officials, and preferred status for mortgages. Documentation does not exempt the unit from any State or Federal taxes. All safety and equipment regulations still apply.

**DOLPHIN** - A group of piles driven close together and bound with wire cables into a single structure.

**DRAFT** - 1. The depth of a boat from the actual water line to the bottom of the lowest part of the boat (e.g., the propeller tip or rudder). 2. The depth of water necessary to float a boat.

**DROGUE** - Any device streamed astern to check a vessel's speed, or to keep its stern up to the waves in a following sea.

**DYE MARKER** - A brightly colored chemical that spreads when released into water; normally used to attract attention.

**EBB TIDE** - A receding tide.



**EVEN KEEL** - To be floating evenly without listing to either side.

**EXHAUST SYSTEM** - The means by which the hot engine (or generator) exhaust gases are moved from the engine to an outboard port and then released into atmosphere.

**EYE SPLICE** - A permanent loop spliced in the end of a line.

**FAST** - Said of an object that is secured to another.

**FATHOM** - Six feet.

**FENDER** - A device (usually constructed of rubber or plastic) positioned so as to absorb the impact between vessels or dock.

**FETCH** - The unobstructed distance that the wind can blow over the water to create waves.

**FLARE** - 1. Outboard curve of the hull as it comes up the side from the waterline; the reverse of tumble home. 2. A pyrotechnic device used for emergency signaling.

**FLAT** - A small deck that is built below decks, specifically to support a piece of equipment.

**FLEMISH** - To coil down a line or rope on deck in a flat, circular, concentric arrangement.

**FLOTSAM** - Floating wreckage, trash or debris.

**FLUKE** - The palm of an anchor.

**FOAM CREST** - The top of the foaming water that speeds toward the beach after a wave has broken, commonly referred to as "white water."

**FOLLOWING SEA** - A sea (waves) moving in the same direction as a vessel.

**FORE-AND-AFT** - A line, or anything else, that runs parallel to the longitudinal center line of a boat.

**FOREFOOT** - The portion of a vessel's keel that curves upward to meet the stem.

**FOREPEAK** - A compartment in the bow of a boat.

**FORWARD** - Toward the bow.

**FREEBOARD** - The minimum vertical distance from the surface of the water to the gunwale.

**FREQUENCY** - The number of crests passing a fixed point at a given time.

**FRONTS** - Where opposing warm and cold air masses meet, generally producing a band of wet, stormy weather wherever they meet.

**GALLEY** - The kitchen area of a boat.

**GALVANIC CORROSION** - A potential electrical difference exists between dissimilar metals immersed in a conductive solution (e.g., salt water). If these metals touch or are otherwise electrically connected, this potential difference produces an electron flow between them. The attack on the less corrosion resistant metal is usually increased and the attack on the more resistant metal is decreased, as compared to when these metals are not touching.

**GANGWAY** - The area of a ship's side where people board and disembark.

**GASKET** - A strip of sealing material, usually rubber, set along the edge of a water or gas tight door, port, cover or hatch.

**GELCOAT** - The thin outer layer of pigmented plastic covering a fiberglass vessel.

**GLAND** - The movable part of a stuffing box, which when tightened, compresses the packing.

**GROUND** - Electrical term meaning the electrical potential of the earth's surface, which is zero.

**GROUND SPEED** - A vessel's speed made good over the earth's surface along a course or track.

**GROUND TACKLE** - The anchor, anchor rodes, and other fittings that are used to secure a vessel at anchor or dockside.

**GUNWALE** - 1. The line where the upper deck and the hull meet. 2. The upper edge of a boat's side.

**HALYARD** - A line used to hoist a flag or pennant.

**HATCHES** - Cover on hatchways.

**HATCHWAYS** - Access ways through decks.

**HARDTOP** - A permanent cover over the cabin or cockpit.

**HAWSER** - A heavy rope or cable used for mooring or towing.

**HEAD** - A toilet or lavatory area.

**HEADING** - The direction that a vessel is going with reference to true, magnetic, or compass north.

**HEADWAY** - The forward motion of a vessel through the water.

**HEAVE TO** - To bring a vessel up in a position where it will maintain little or no headway, usually with the bow into the wind.

**HEAVY WEATHER** - Stormy weather with high seas and strong winds.

**HEEL** - To tip to one side.

**HELM** - The wheel or tiller that manually controls the boat's steering system.

**HELMSMAN** - The individual steering the vessel.

**HIGHS** - A center of pressure surrounded by lower pressure on all sides. Caused by a mass of cooler, sinking, drier air. This raises the area ground level air pressure and provides clear skies.

**HULL** - The main body of a boat.

**INBOARD** - 1. From either the port or starboard side of a boat toward the fore-and-aft centerline of a boat. 2. The dock side of a moored boat.

**INLAND RULES** - Nautical "Rules-of-the-Road" that apply in U.S. lakes, rivers, and coastal waters.

**INTERNATIONAL RULES** - Nautical "Rules-of-the-Road" that are in effect by international agreement to the high seas.

**ISOBARS** - Lines of equal air pressure that connect all the local points on a weather map. These lines are usually closed and define high or low pressure air masses.

**ISOTHERMS** - Isotherms are lines that are similar to Isobars except that Isotherms connect all the points that are of equal temperature.

**JETSAM** - Refuse that sinks when discharged overboard.

**KEDGE(S)** - One or more anchors set out from a grounded vessel, usually astern, to 1) keep it from being driven further aground and 2) to aid in refloating.

**KEEL** - 1. The centerline of a boat hull bottom running fore and aft, 2. The backbone of a vessel.

**KNOT** - 1. A maritime unit of speed equal to one nautical mile per hour (6076 feet). 2. A term for hitches and bends.

**LANYARD** - A short line made fast to an object to secure it.

**LATITUDE** - The measure of angular distance in degrees, minutes, and seconds, north or south of the equator.

**LAZARETTE** - Storage compartment in the deck at the stern.

**LEADLINE** - A weighted line used to take depth measurements.

**LEE** - The direction opposite that of the wind.

**LEEWARD** - Away from the wind.

**LIST** - A vessel that inclines to port or starboard.

**LORAN** - Long Range Navigation. An electronic system whereby a navigator can determine position regardless of weather.

**LONGITUDINAL** - Running lengthwise.

**LOWS** - A region of low atmospheric pressure. Hurricanes are extremely concentrated low pressure systems.

**LUBBER LINE** - A mark or line on the compass parallel to the keel indicating forward.

**MAST** - A spar that is set upright to support lighting, rigging, or sails.

**MODEL DESIGNATOR** - Model identifier or model name.

**MOORING** - An arrangement for securing a boat to a mooring buoy or pier.

**NAVIGATION LIGHTS** - A set of red and green or white lights which must be shown by all vessels between dusk and dawn.

**OVERHEAD** - A ceiling or roof of a vessel.

**OVERBOARD** - Over the side of the boat.

**OUTBOARD** - 1. From the fore-and-aft centerline of a boat toward both the port and starboard sides. 2. The seaward side of a moored boat. 3. An engine that is mounted externally onto the transom of a boat.

**PAINTER** - A line to the bow of a small boat used for making fast.

**PASSAGEWAY** - A corridor or hallway aboard ship.

**PENNANT** - The line by which a boat is made fast to a mooring buoy; also pendant.

**PERSONAL Flotation DEVICE (PFD)** - A life preserver.

**PIER** - A loading platform that extends at an angle from the shore.

**PILASTER** - A rectangular structural support column that is an extension of the port and starboard aft cabin sides and which supports the hardtop and flybridge.

**PILING** - Support, or protection for wharves, piers, etc.

**PITCH** - 1. The vertical (up and down) motion of a bow in a seaway, about the athwartships axis. 2. The axial advance of a propeller during one complete revolution.

**PITCHPOLING** - A boat being thrown end-over-end.

**PLACARD** - A board or stiff card bearing a notice, advertisement, message, etc.

**PLANING HULL** - At slow speeds, a planing hull will displace water in the same manner as a displacement hull. As speed is increased, the hull provides a lifting effect up onto the surface of the water.

**POINT** - One of 32 points of the compass that is equal to 11-1/4 degrees.

**PORT** - 1. Looking forward, the left side of a boat, 2. A harbor, 3. An opening for light or ventilation or passage of material in the side of a boat.

**PORT BEAM** - The left-center of a boat.

**PORT BOW** - Facing the bow, the front left side.

**PORT QUARTER** - Looking forward, a vessel's left rear section.

**QUARTER** - The sides of a boat aft of amidships.

**QUARTERING SEA** - Sea coming on a boat's quarter.

**RED-RIGHT-RETURNING** - A term for helmsmen that buoys and day markers are on the right when returning from seaward.

**REEF** - A shallow underwater barrier.

**REEVE** - To pass a line through a block or other opening.

**RIDGES** - High pressure fingers extending out from a high.

**RODE** - The anchor line or chain.

**RUNNING LIGHTS** - Lights required to be shown on boats underway between sundown and sunup.

**RUDDER** - A vertical plate for steering a boat.

**SALON** - The main social cabin on a vessel, usually the largest area, occasionally referred to as the deckhouse.

**SCREW** - A propeller.

**SCUPPER** - A drain from the edge of a deck that discharges overboard.

**SEACOCK** - A positive action shut-off valve connected directly to the hull seawater intake and discharge piping.

**SERIES** - A group of waves which seem to travel together and at about the same speed.

**SHACKLE** - A "U" shaped connector with a pin or bolt across the open end.

**SHAFT** - The long, round member that connects the engine or transmission to the propeller.

**SHAFT LOG** - A fitting at the hull bottom where the shaft connecting an engine to its propeller penetrates the hull. A shaft log permits the shaft to rotate while simultaneously preventing water from entering the hull.

**SHEER** - The top of the hull's curvature at the deck line from the bow to the stern.

**SHEER STRAKE** - The upper edge of the hull, immediately below the deck.

**SHEET BEND** - A knot used to join tow ropes.

**SHOAL** - An area of shallow water.

**SILENCER** - A baffled chamber installed in an exhaust system to reduce the noise.

**SOLE** - Term for deck, cabin or cockpit floor.

**SPAR** - A general term for booms, masts, yards etc.

**SPRING LINE** - A pivot line used in docking, undocking, or to prevent the boat from moving forward or astern while made fast to a dock.

**STARBOARD** - Looking forward, the right side of a boat.

**STARBOARD BEAM** - The right-center of a boat.

**STARBOARD BOW** - When facing the bow, the front right side.

**STARBOARD QUARTER** - When looking forward, the right rear section of the boat.

**STEERAGEWAY** - The lowest speed at which a vessel can be controlled by the steering wheel.

**STEM** - The leading edge of a boat's hull.

**STERN** - The back of a boat.

**STRINGER** - A fore and aft continuous member used to provide a vessel longitudinal strength.

**STRUT** - A propeller shaft support that is below the hull.

**SUMP** - A pit or well into which water is drained.

**SUPERSTRUCTURE** - Deck houses and other structures extending above the deck.

**THWART** - A seat or brace running laterally across a boat.

**THWARTSHIPS** - At right angles to the centerline.

**TILLER** - A bar or handle for turning a boat's rudder, or motor.

**TOPSIDE** - To go up to the top deck.

**TRANSOM** - The stern cross-section of a square sterned boat

**TRANSVERSE** - Across the vessel; athwartships.

**TRIM** - Fore and aft balance of a boat.

**TROUGH** - 1. The valley that exists between waves.  
2. A trough is the opposite of a ridge in that it is an elongated low-pressure area extending out from a low. A trough normally indicates unsettled weather.

**TUMBLE HOME** - The opposite of flare. The shape of the hull as it moves outboard going down from the gunwale to the waterline or chine.

**UNDERWAY** - Movement. Usually referring to a vessel proceeding forward.

**V-BOTTOM** - A hull with the bottom section in the shape of a "V."

**V DRIVE** - A drive system that has the output of the engine facing forward and coupled to a transmission. The prop shaft is then coupled to the transmission.

**WAKE** - Moving waves, track or path that a boat leaves behind it when moving across the water.



**WATER LINE** - The line of the water on the hull when the vessel is afloat.

**WATCH** - A 4 hour duty period while at sea.

**WAVES** - Waves are periodic disturbances of the sea's surface, caused by wind, seaquakes, and the gravitational pull of the moon and the sun.

**WAVE GRADIENT** - A wave's slope or angle from trough to crest with respect to the horizon.

**WAVE HEIGHT** - From the bottom of a wave's trough to the top of the crest.

**WEATHER DECK** - A deck with no overhead protection.

**WET EXHAUST** - This term refers to an exhaust system where the cooling seawater is mixed with the exhaust gases just after the riser. This mixture is then ejected through the drive or ports located in the transom or hull sides.

**WHARF** - A man-made structure bounding the edge of a dock and built along the shoreline.

**WHIPPING** - The act of wrapping the end of a piece of rope with small line, tape or plastic to prevent it from fraying.

**WINDLASS** - A device used to raise and lower the anchor.

**WINDWARD** - Toward the direction from which the wind is coming.

**YAW** - 1. To swing off course, as when due to the impact of a following or quartering sea. 2. Any motion about a vertical axis.



Copy this page and fill out before going boating. Leave the completed copy with a reliable person who can be depended upon to notify the Coast Guard, or other rescue organization, should you not return as scheduled. **DO NOT** file this plan with the Coast Guard.

Name \_\_\_\_\_ Telephone \_\_\_\_\_

Description of Boat \_\_\_\_\_ Type \_\_\_\_\_ Color \_\_\_\_\_ Trim \_\_\_\_\_

Registration Number \_\_\_\_\_

Length \_\_\_\_\_ Name \_\_\_\_\_ Make \_\_\_\_\_

Four Winns® Hull Identification Number \_\_\_\_\_

Other Information \_\_\_\_\_

Persons Aboard: Name	Age	Address	Telephone

Engine Type \_\_\_\_\_ HP \_\_\_\_\_

Number of Engines \_\_\_\_\_ Fuel Capacity \_\_\_\_\_

**Survival Equipment:**

PFDs \_\_\_\_\_ Flares \_\_\_\_\_ Mirror \_\_\_\_\_

Smoke Signals \_\_\_\_\_ Flashlight \_\_\_\_\_ Food \_\_\_\_\_

Paddles \_\_\_\_\_ Water \_\_\_\_\_ Anchor \_\_\_\_\_

Raft or Dinghy \_\_\_\_\_ EPIRB \_\_\_\_\_ Sea Anchor \_\_\_\_\_

**Navigation Equipment:**

Compass \_\_\_\_\_ Loran \_\_\_\_\_ GPS \_\_\_\_\_ Radar \_\_\_\_\_

Radio: Yes \_\_\_\_\_ No \_\_\_\_\_ Type \_\_\_\_\_ Frequency \_\_\_\_\_

Phone: Yes \_\_\_\_\_ No \_\_\_\_\_ Phone Number \_\_\_\_\_

Destination \_\_\_\_\_ Estimated Time of Arrival \_\_\_\_\_

Expected to Return By \_\_\_\_\_

AutoType \_\_\_\_\_ License No. \_\_\_\_\_ Where \_\_\_\_\_

If not returned by \_\_\_\_\_ call the Coast Guard, or \_\_\_\_\_  
Local Marine Authority

Coast Guard Telephone Number: \_\_\_\_\_

Local Marine Authority Telephone Number: \_\_\_\_\_











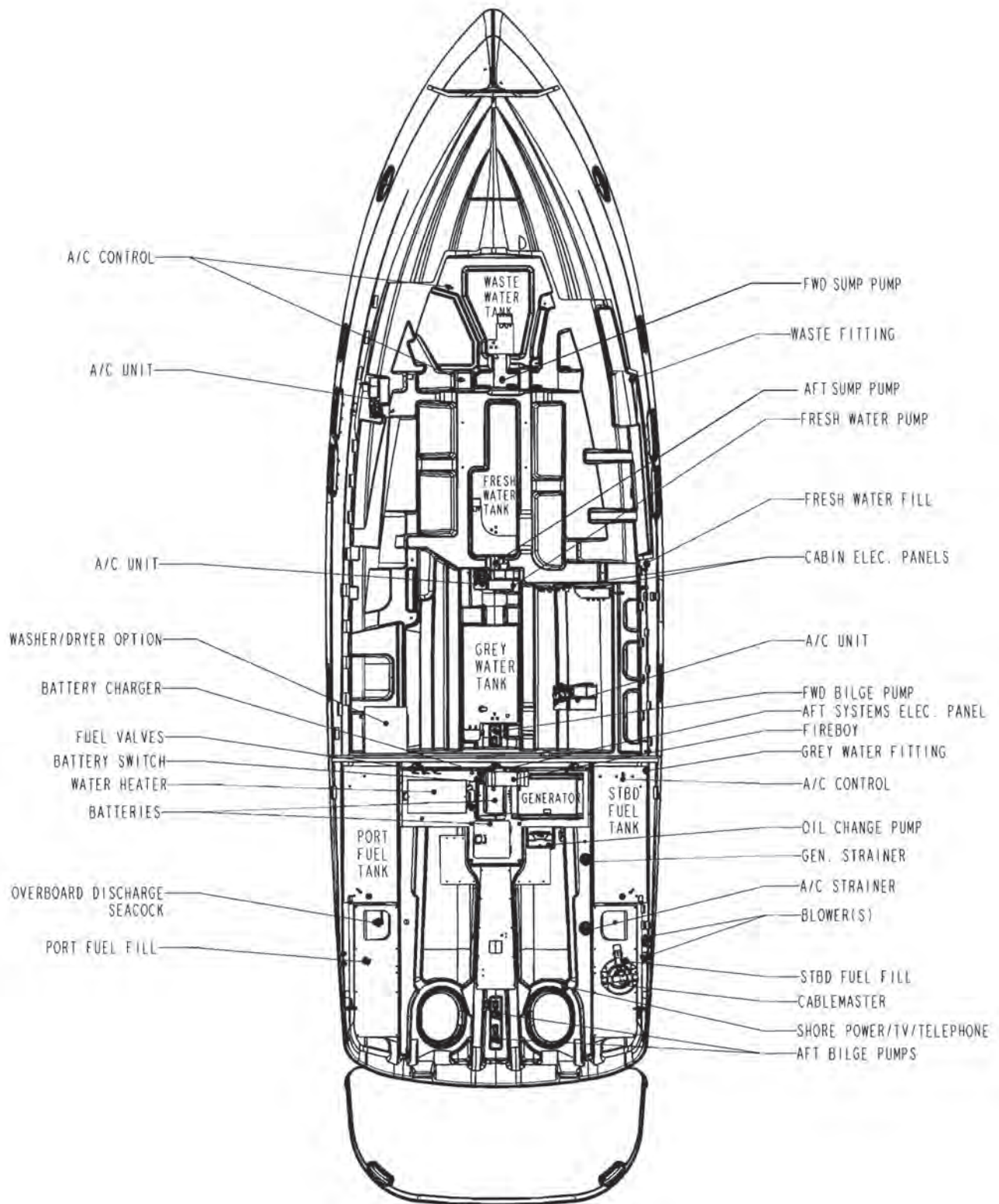






BOAT MODEL	
HULL IDENTIFICATION NUMBER	
ENGINE MODEL	
ENGINE SERIAL NUMBER(S)	
DRIVE MODEL	
DRIVE SERIAL NUMBER(S)	
PROPELLER DIAMETER	
PROPELLER PITCH	
PROPELLER PART NUMBER(S)	
OIL FILTER NUMBER	
BOAT COLOR	
COCKPIT UPHOLSTERY COLOR	
CABIN UPHOLSTERY COLOR	
FUEL CAPACITY	
FUEL: ESTIMATED AVG. GALLON/HR USAGE	
IGNITION KEY NUMBER(S)	
COMPANIONWAY KEY NUMBER	
SELLING DEALER	
ADDRESS	
CITY & STATE	
PHONE NUMBER	
MISCELLANEOUS	

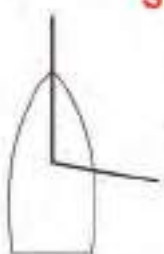







**Note: Representative Locations Only - availability and locations of equipment may vary depending on optional equipment installed. Locations and availability is subject to change without notice.**



# Navigational Aids Chart

## REMEMBER THESE RULES

1. OVERTAKING - PASSING: Boat being passed has the right-of-way. **KEEP CLEAR.**
2. MEETING HEAD ON: Keep to the right.
3. CROSSING: Boat on right has the right-of-way. Slow down and permit boat to pass.

<p><b>← PORT</b></p> <p>Yield right-of-way to boats in your DANGER ZONE!</p>  <p><b>STARBOARD →</b></p> <p>DANGER ZONE (Dead ahead to 2 points abaft your starboard beam)</p>	<h3>STORM WARNINGS</h3>  <p><b>RED FLAG</b> Small craft (winds to 33 knots)</p> <p><b>2 RED FLAGS</b> Gale (winds up to 47 knots)</p> <p><b>SQUARE RED FLAG BLACK BOX</b> (Storm)</p> <p><b>2 SQUARE RED FLAGS BLACK BOX</b> (Hurricane)</p>												
<h3>WHISTLE SIGNALS</h3> <p><b>ONE LONG BLAST:</b> Warning signal (Coming out of slip)</p> <p><b>ONE SHORT BLAST:</b> Pass on my port side</p> <p><b>TWO SHORT BLASTS:</b> Pass on my starboard side</p> <p><b>THREE SHORT BLASTS:</b> Engine(s) in reverse</p> <p><b>FIVE OR MORE BLASTS:</b> Danger signal</p>	<h3>BRIDGE SIGNALS</h3> <table border="0"> <tr> <td><b>SOUND</b></td> <td><b>VISUAL</b></td> </tr> <tr> <td>VESSEL: Open: —●</td> <td>VESSEL: Open: </td> </tr> <tr> <td>BRIDGE: OK: —●</td> <td>BRIDGE: OK: Same or Same</td> </tr> <tr> <td>No: ●●●●●</td> <td>No: </td> </tr> <tr> <td>VESSEL: Replies: ●●●●●</td> <td></td> </tr> <tr> <td><b>RADIO: VHF CH. 13</b></td> <td></td> </tr> </table>	<b>SOUND</b>	<b>VISUAL</b>	VESSEL: Open: —●	VESSEL: Open: 	BRIDGE: OK: —●	BRIDGE: OK: Same or Same	No: ●●●●●	No: 	VESSEL: Replies: ●●●●●		<b>RADIO: VHF CH. 13</b>	
<b>SOUND</b>	<b>VISUAL</b>												
VESSEL: Open: —●	VESSEL: Open: 												
BRIDGE: OK: —●	BRIDGE: OK: Same or Same												
No: ●●●●●	No: 												
VESSEL: Replies: ●●●●●													
<b>RADIO: VHF CH. 13</b>													

## LATERAL AIDS AS SEEN ENTERING FROM SEAWARD

<h3>PORT SIDE ODD NUMBERED AIDS</h3> <p><b>GREEN LIGHT ONLY</b></p> <p>FLASHING: </p> <p>OCULTING: </p> <p>QUICK FLASHING: </p> <p>ISOPHASE: </p> <p><b>LIGHTED BUOY</b>:  G 3" FI G 4sec</p> <p><b>CAN</b>:  G 7"</p> <p><b>DAYMARK</b>:  SG 1" G 1"</p>	<h3>SAFE WATER MID-CHANNELS OR FAIRWAYS NO NUMBERS — MAY BE LETTERED</h3> <p>□ WHITE LIGHT ONLY    □ MORSE CODE</p> <p>Mo (A) □ □ □ □</p> <p><b>SPHERICAL</b>:  RW SP "G"</p> <p><b>MIR</b>:  RW "A"</p> <p><b>LIGHTED AND/OR SOUND</b>:  RW "W" Mo (A)</p> <hr/> <h3>PREFERRED CHANNEL</h3> <p>COMPOSITE GROUP FLASHING (2 + 1) □ □ □ □ □ □ □ □ □ □</p> <p><b>GREEN LIGHT ONLY</b></p> <p><b>RED LIGHT ONLY</b></p> <p><b>LIGHTED</b></p> <p><b>PREFERRED CHANNEL TO STARBOARD TOPMOST BAND GREEN</b>:  GR "C" FI (2 + 1) G C 1"</p> <p><b>PREFERRED CHANNEL TO PORT TOPMOST BAND RED</b>:  RS "B" FI (2 + 1) R N "W"</p> <p><b>CAN</b>:  GR "A"</p> <p><b>NUN</b>:  JR "B" RW "W"</p> <p><b>DAYMARK</b>:  JG "A" GR "A"</p>	<h3>STARBOARD SIDE EVEN NUMBERED AIDS</h3> <p><b>RED LIGHT ONLY</b></p> <p>FLASHING: </p> <p>OCULTING: </p> <p>QUICK FLASHING: </p> <p>ISOPHASE: </p> <p><b>LIGHTED BUOY</b>:  R 3" FI R 4sec</p> <p><b>NUN</b>:  R 6"</p> <p><b>DAYMARK</b>:  TR 2" R 2"</p>
---	---	---

