

CONTENTS

TABLE OF CONTENTS.....	1
TABLE OF CONTENTS.....	2
TABLE OF CONTENTS.....	3

AC CIRCUITS/PANELS

AC PANEL 120V.....	4
AC PANEL 220V.....	5
AC OUTLETS 120V.....	6
AC OUTLETS 220V.....	7
AIR CONDITIONING.....	8
BATTERY CHARGER.....	9
COCKPIT REFRIDGERATOR.....	10
GENERATOR.....	11
GENERATOR DIESEL.....	12
MICROWAVE.....	13
PRO MARINER CHARGER.....	14
SHOREPOWER BREAKER.....	15
WATER HEATER.....	16

DC CIRCUITS

12V AND USB OUTLETS.....	17
AUTO FIRE EXT AXIUS.....	18
AUTO FIRE EXT DTS.....	19

AUTO FIRE EXT STANDARD.....	20
BILGE BLOWERS.....	21
BILGE PUMP, CABIN.....	22
BILGE PUMP, ENGINE.....	23
BONDING.....	24
CAPTAIN'S CALL PORT.....	25
CAPTAIN'S CALL STBD.....	26
CO DETECTOR.....	27
COCKPIT HEATER.....	28
DC DISTRIBUTION AXIUS/DTS.....	29
DC DISTRIBUTION STANDARD.....	30
DEPTH SOUNDER AXIUS.....	31
DEPTH SOUNDER DTS.....	32
DEPTH SOUNDER STANDARD.....	33
ENGINE EXTENSION HARNESS.....	34
ENGINE HATCH RAM.....	35
ENGINE HATCH RAM/W SKI PYLON..	36
FIRE SHUTDOWN BOX DIESEL.....	37
FUME DETECTOR.....	38
GPS/GARMIN.....	39
HEAD BLOWER.....	40

CONTENTS

HIGH WATER ALARM.....	41	WATER PUMP.....	64
HORN.....	42	WINDLASS.....	65
INVERTER.....	43	WINDLASS DETAIL.....	66
L I G H T S		WIPER.....	67
CABIN LIGHTS.....	44	<u>DC PANELS</u>	
COURTESY LIGHTS.....	45	ACCESSORY PANEL.....	68
DOCKING LIGHTS.....	46	AFT BREAKER PANEL.....	69
HEAD UNIT LIGHTS.....	47	BATT. SWITCH PANEL DTS/AXIUS.....	70
NAV/ANCH LIGHTS.....	48	BATT. SWITCH PANEL STANDARD.....	71
SPOTLIGHT.....	49	CABIN DC PANEL.....	72
MACERATOR.....	50	DASH BREAKER PANEL.....	73
MERCATHODE.....	51	IGN PANEL AXIUS/DTS.....	74
OUTDRIVE PUMP.....	52	IGN PANEL STANDARD.....	75
SHOWER SUMP.....	53	MAIN PANEL EVC.....	76
START SOLENOID.....	54	MAIN PANEL PERFORMANCE.....	77
STEREO AMP STANDARD.....	55	MAIN DASH SMARTCRAFT.....	78
STEREO AMP/W SUB.....	56	MAIN DASH STANDARD.....	79
STEREO HEAD UNIT.....	57	MAIN PANEL VESSELVIEW.....	80
STEREO SPEAKERS.....	58	TRIM PANEL AXIUS/DTS.....	81
TRIM TABS.....	59	TRIM PANEL STANDARD.....	82
VHF RADIO.....	60		
VHF RADIO 2.....	61		
WASTE SYSTEM.....	62		
WATER LEVEL GAUGE.....	63		

CONTENTS

PLUMBING

BILGE PUMPS.....83
SHOWER SUMP.....84
WASTE SYSTEM.....85
WATER SYSTEM.....86

FUEL

FUEL TANK.....87
FUEL TANK DIESEL.....88

WIRE IDENTIFICATION			
WIRE COLOR	STRIPE	STRIPE	ABBREVIATION
BROWN	ORANGE	WHITE	BN/OR/WH

CODE	COLOR
BK	BLACK
BL	BLUE
RD	RED
PR	PURPLE
YL	YELLOW
GY	GRAY
BN	BROWN
OR	ORANGE
WH	WHITE
GN	GREEN

120V AC SYSTEM PANEL

(REAR VIEW)

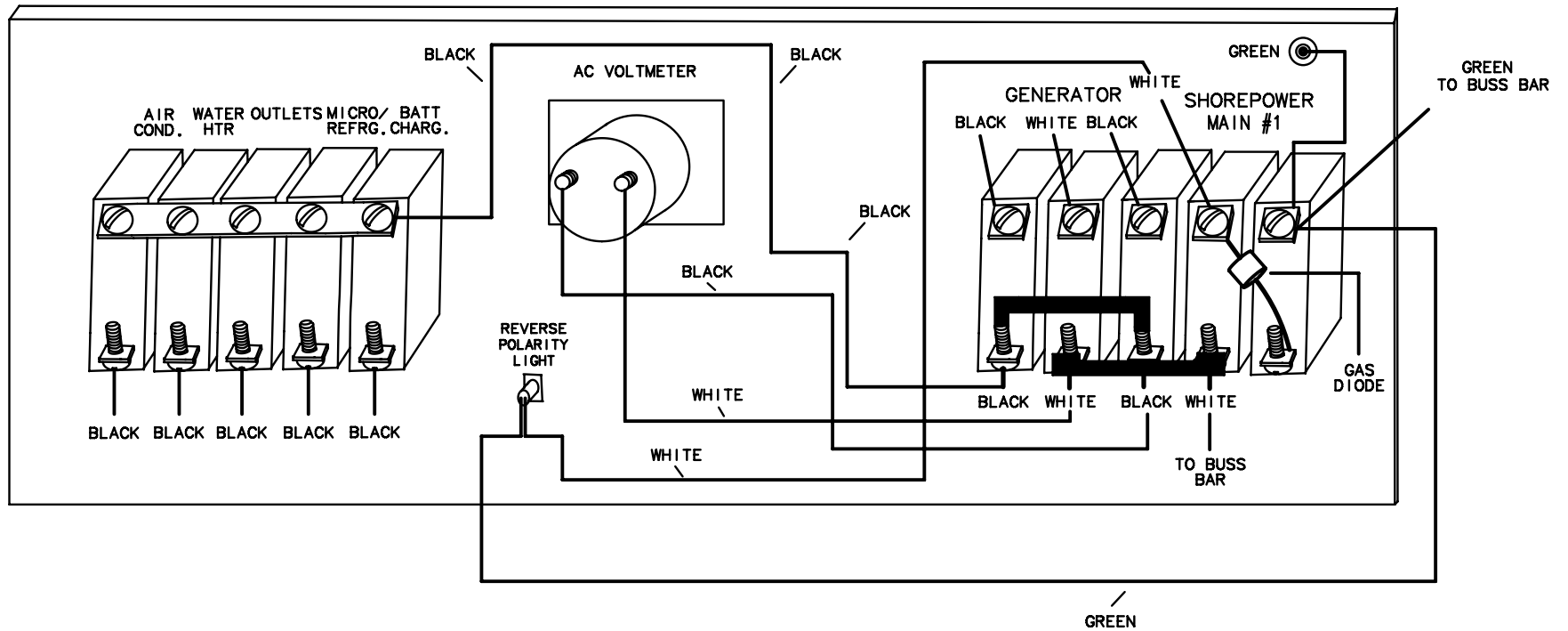

TITLE: AC PANEL 120V		THUNDERBIRD PRODUCTS
		P.O. BOX 1003
MOD.: 330 CBR	DR BY: KPP	DECATUR IN., 46733
NO.: 4	DATE: 7-1-15	(260) 724-9111

220V AC SYSTEM PANEL

(REAR VIEW)

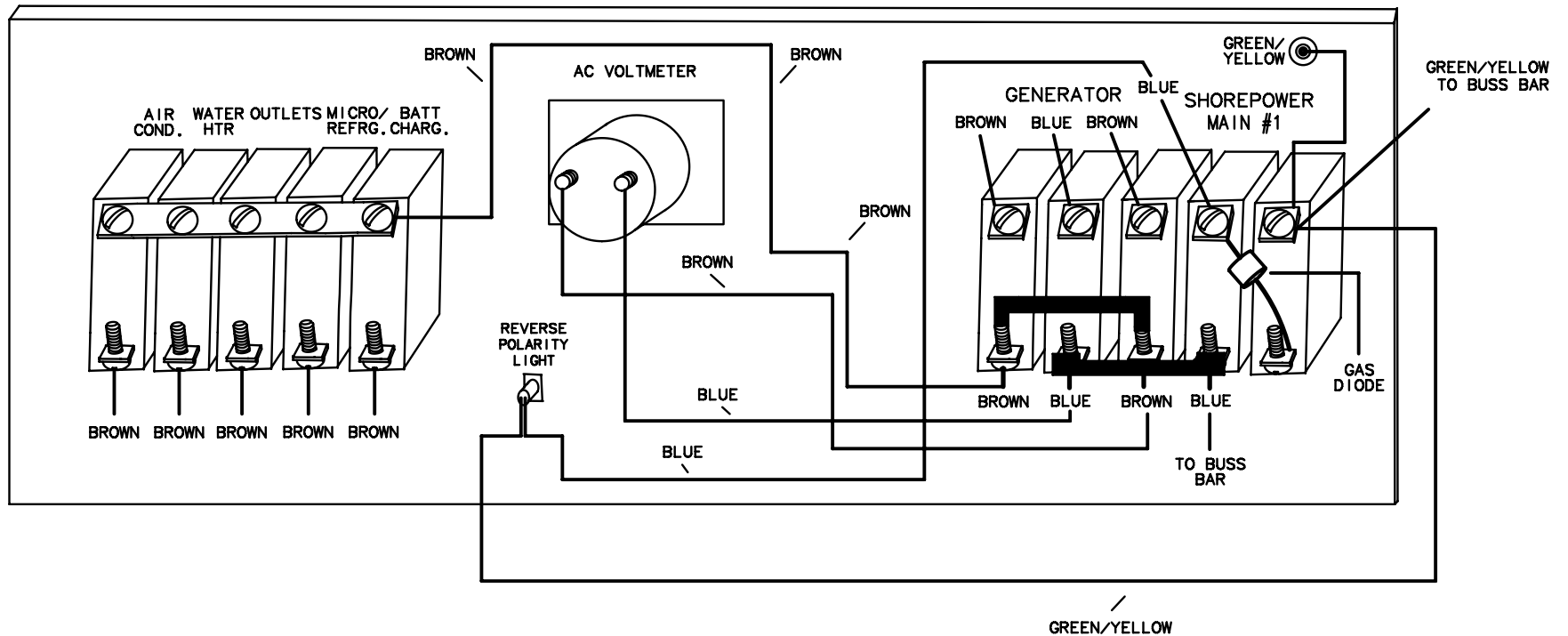

TITLE: AC PANEL 220V		THUNDERBIRD PRODUCTS	
		P.O. BOX 1003	
MOD.: 330 CBR	DR BY: KPP	DECATUR IN., 46733	
NO.: 5	DATE: 7-1-15	(260) 724-9111	

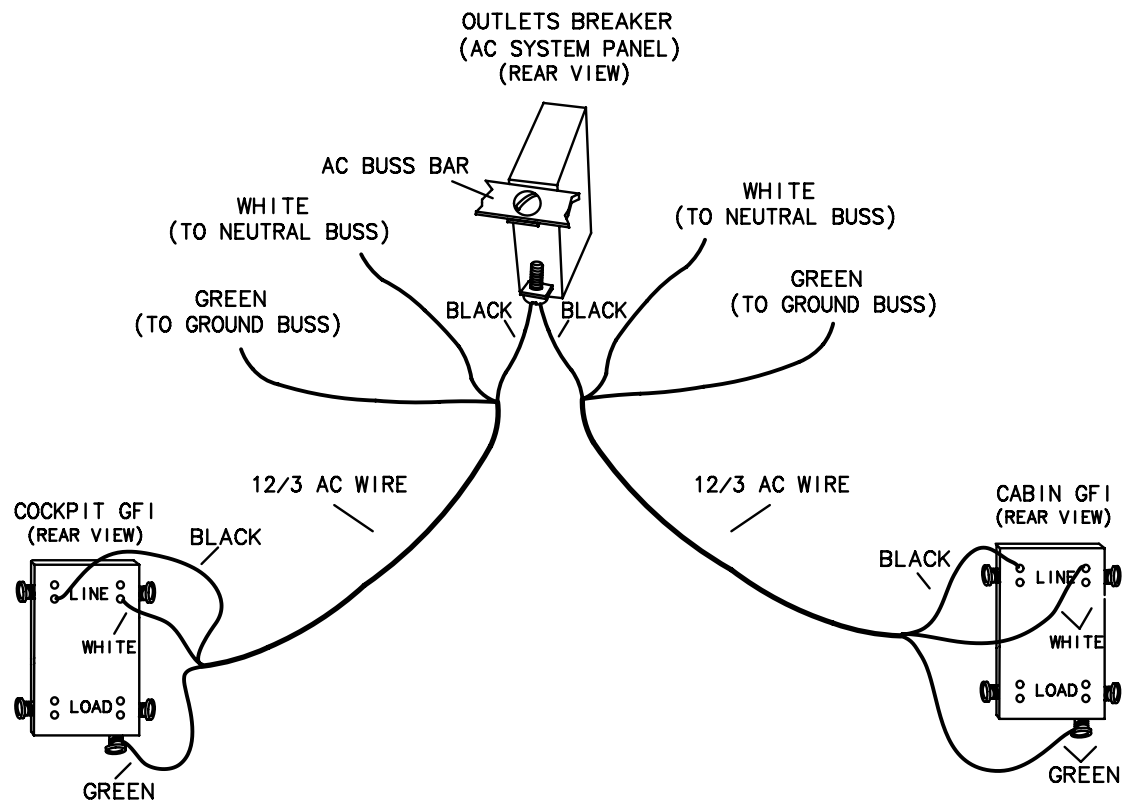
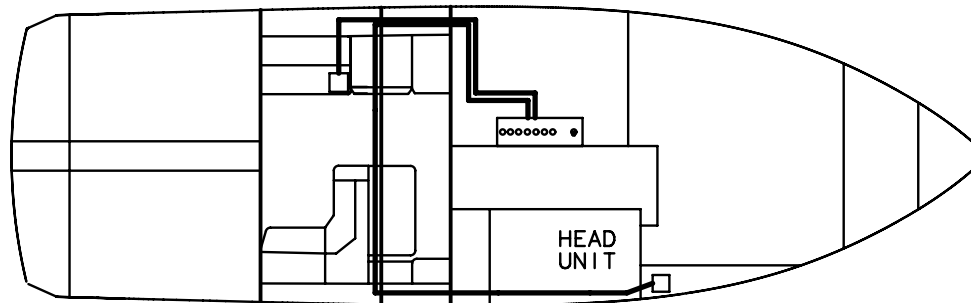

TITLE: 120V OUTLETS		THUNDERBIRD PRODUCTS
		P.O. BOX 1003
MOD.: 330 CBR	DR BY: KPP	DECATUR IN., 46733
NO.: 6	DATE: 7-1-15	(260) 724-9111

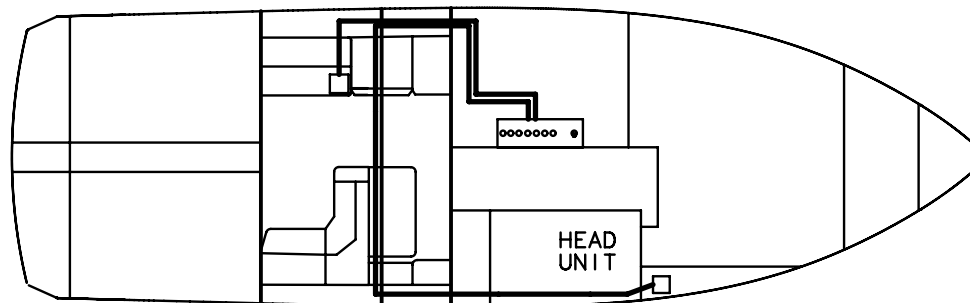
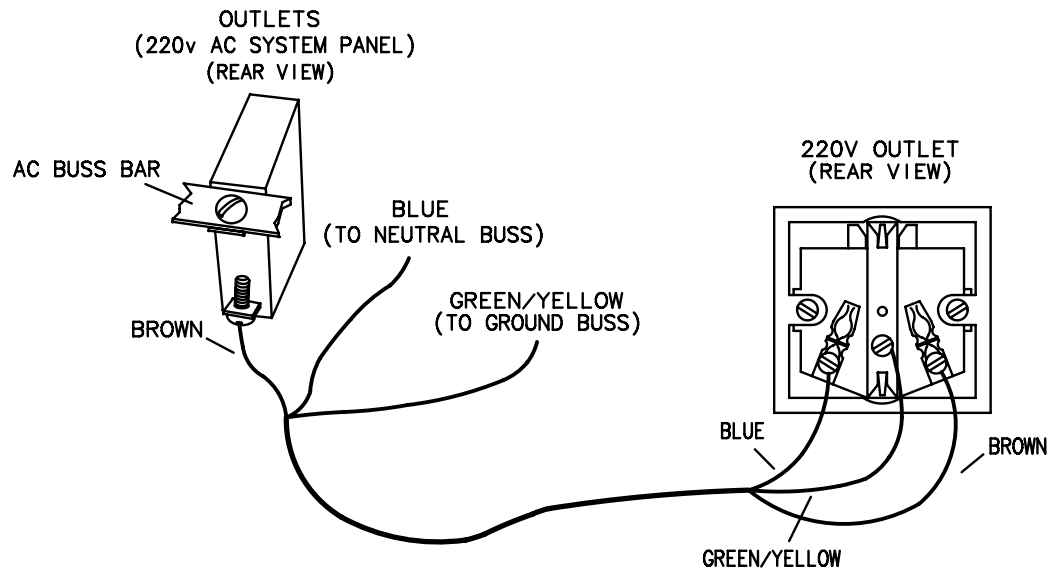

TITLE: 220V OUTLETS		THUNDERBIRD PRODUCTS
		P.O. BOX 1003
MOD.: 330 CBR	DR BY: KPP	DECATUR IN., 46733
NO.: 7	DATE: 7-1-15	(260) 724-9111

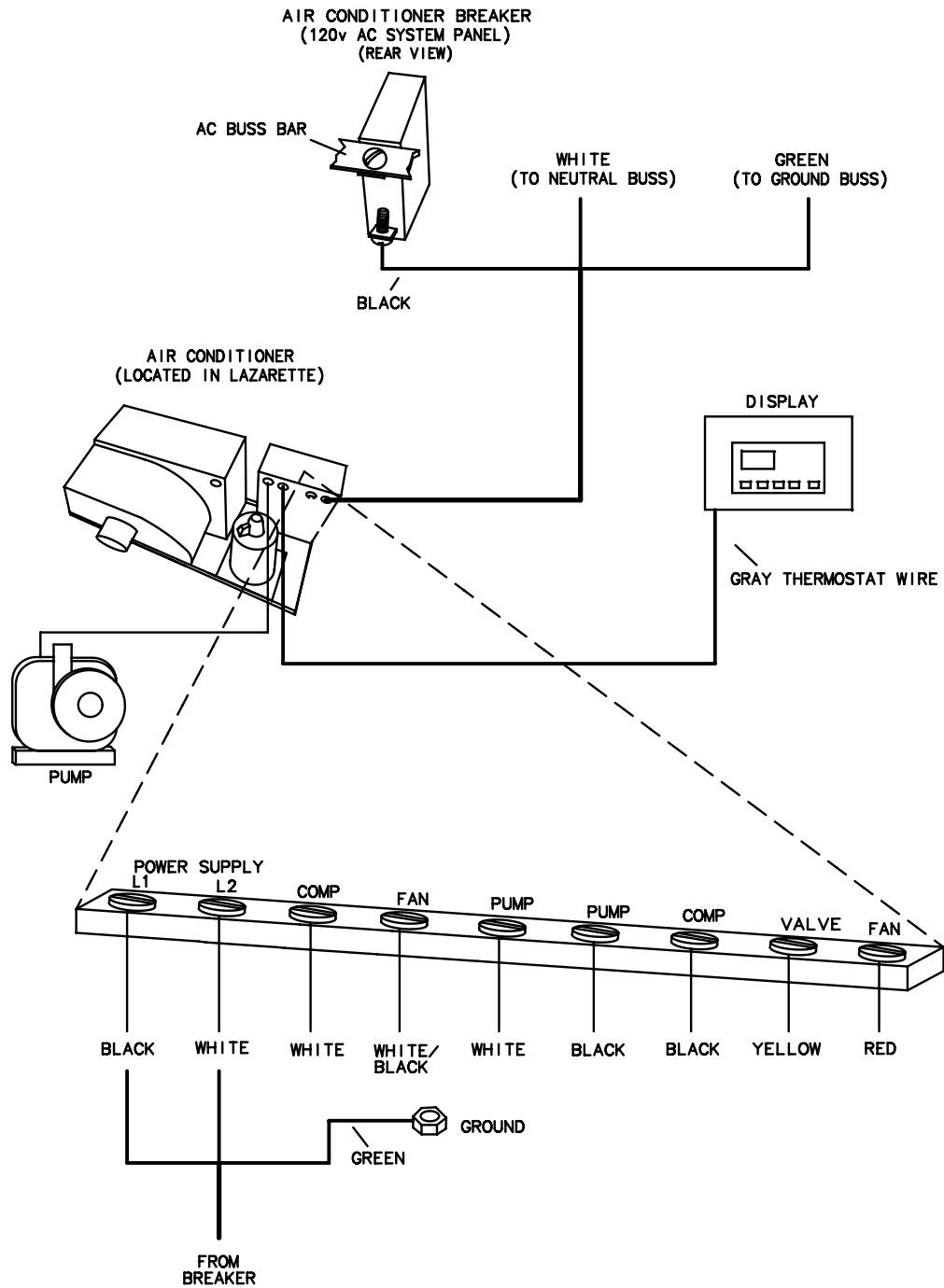

TITLE: AIR CONDITIONING		THUNDERBIRD PRODUCTS
		P.O. BOX 1003
MOD.: 330 CBR	DR BY: KPP	DECATUR IN., 46733
NO.: 8	DATE: 7-1-15	(260) 724-9111

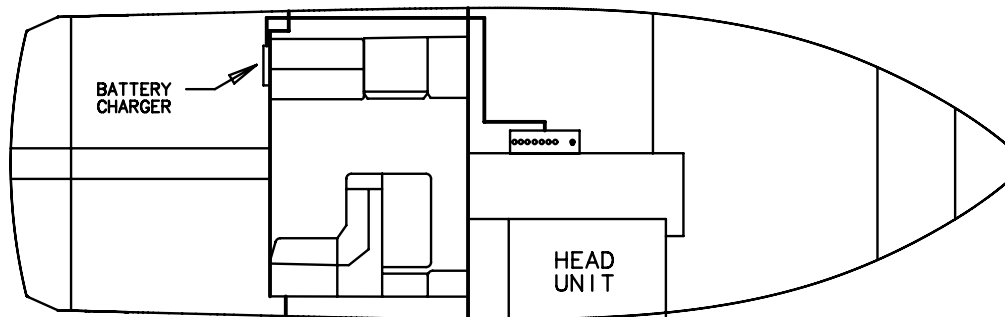

BATTERY CHARGER BREAKER
(120v AC SYSTEM PANEL)
(REAR VIEW)

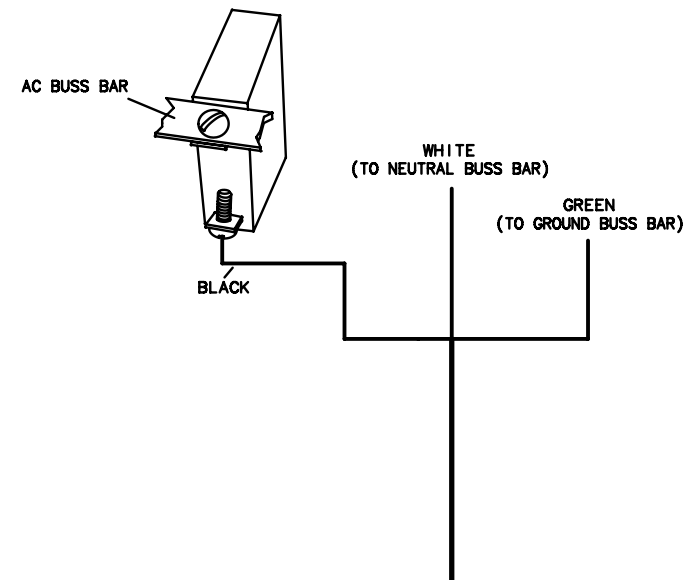

DETAIL VIEW
(CONNECTIONS INSIDE)

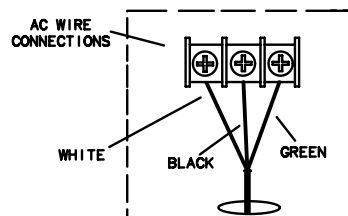

SEE DC DISTRIBUTION PAGE
FOR BATTERY CHARGER DC WIRING.

TITLE: BATTERY CHARGER		THUNDERBIRD PRODUCTS
		P.O. BOX 1003
MOD.: 330 CBR	DR BY: KPP	DECATUR IN., 46733
NO.: 9	DATE: 7-1-15	(260) 724-9111

LEGEND

C-BREAKER PANEL 

PLUG INTERCONNECT 

CABIN AC/DC PANEL 

CKPT FRIDGE BREAKER
(AFT BREAKER PANEL)
(REAR VIEW)

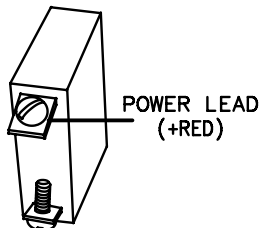

POWER LEAD
(+RED)

POWER LEAD
(+RED/BLUE/BLUE)

GROUND
(-BLACK)

CAPACITOR

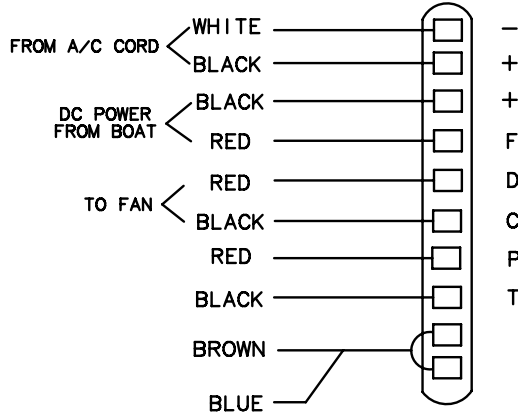

MICRO/REFRG BREAKER
(120v AC SYSTEM PANEL)
(REAR VIEW)

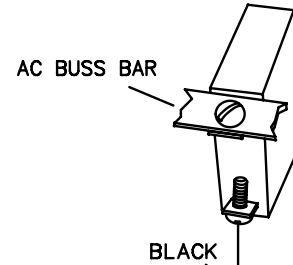

AC BUSS BAR

WHITE
(TO NEUTRAL BUSS)

BLACK

GREEN
(TO GROUND BUSS)

STANDARD AC PLUG

COCKPIT FRIDGE
OUTLET

BLACK

WHITE

GREEN

(REAR VIEW)

FRIDGE

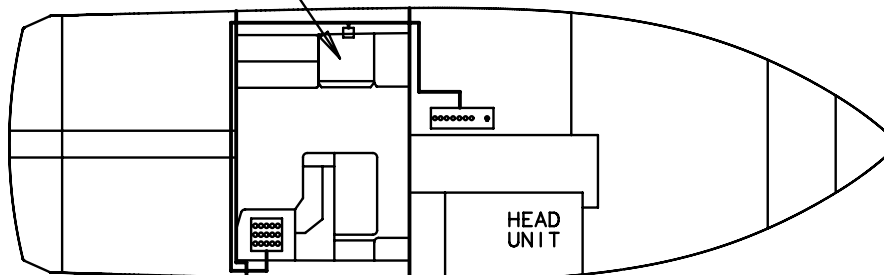

TITLE: COCKPIT REFRIDGERATOR		THUNDERBIRD PRODUCTS
		P.O. BOX 1003
MOD.: 330 CBR	DR BY: KPP	DECATUR IN., 46733
NO.: 10	DATE: 7-1-15	(260) 724-9111

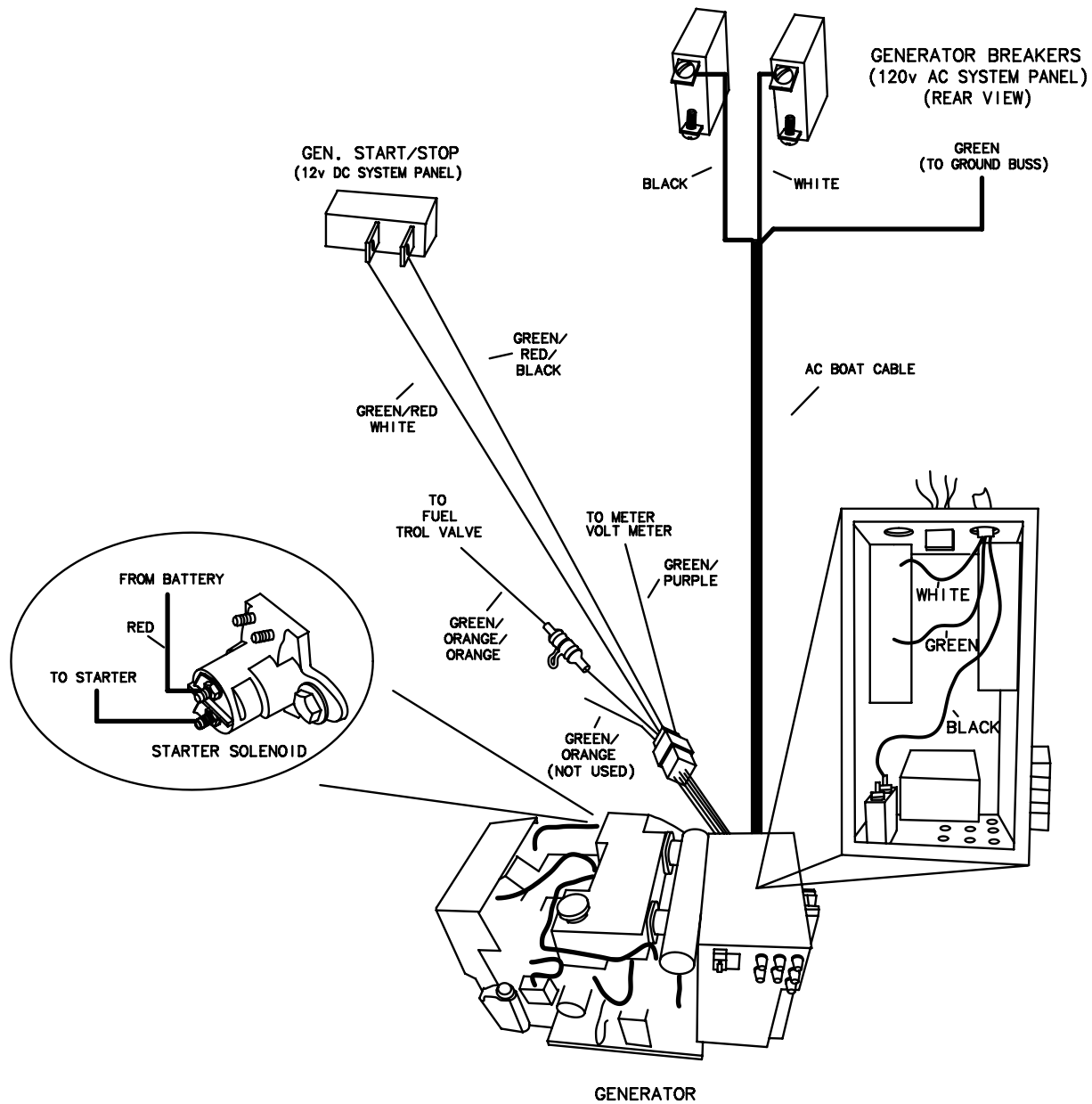

TITLE: GENERATOR		THUNDERBIRD PRODUCTS
		P.O. BOX 1003
MOD.: 330 CBR	DR BY: KPP	DECATUR IN., 46733
NO.: 11	DATE: 7-1-15	(260) 724-9111

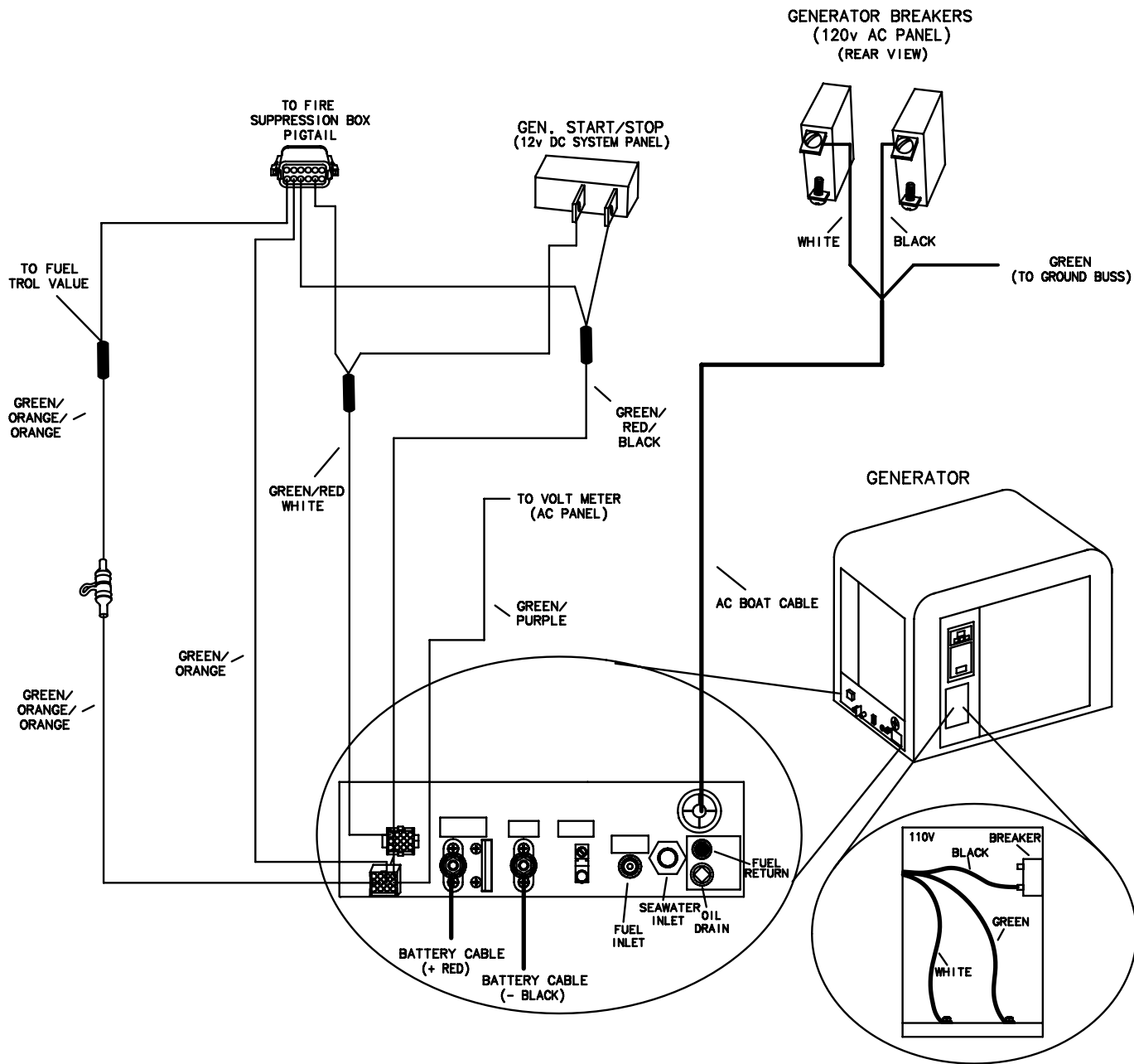

TITLE: GENERATOR (DIESEL)		THUNDERBIRD PRODUCTS
		P.O. BOX 1003
MOD.: 330 CBR	DR BY: KPP	DECATUR IN., 46733
NO.: 12	DATE: 7-1-15	(260) 724-9111

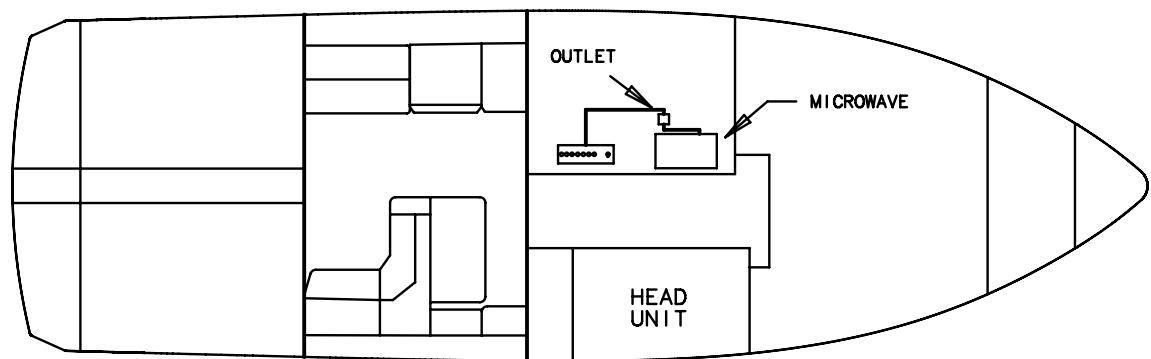
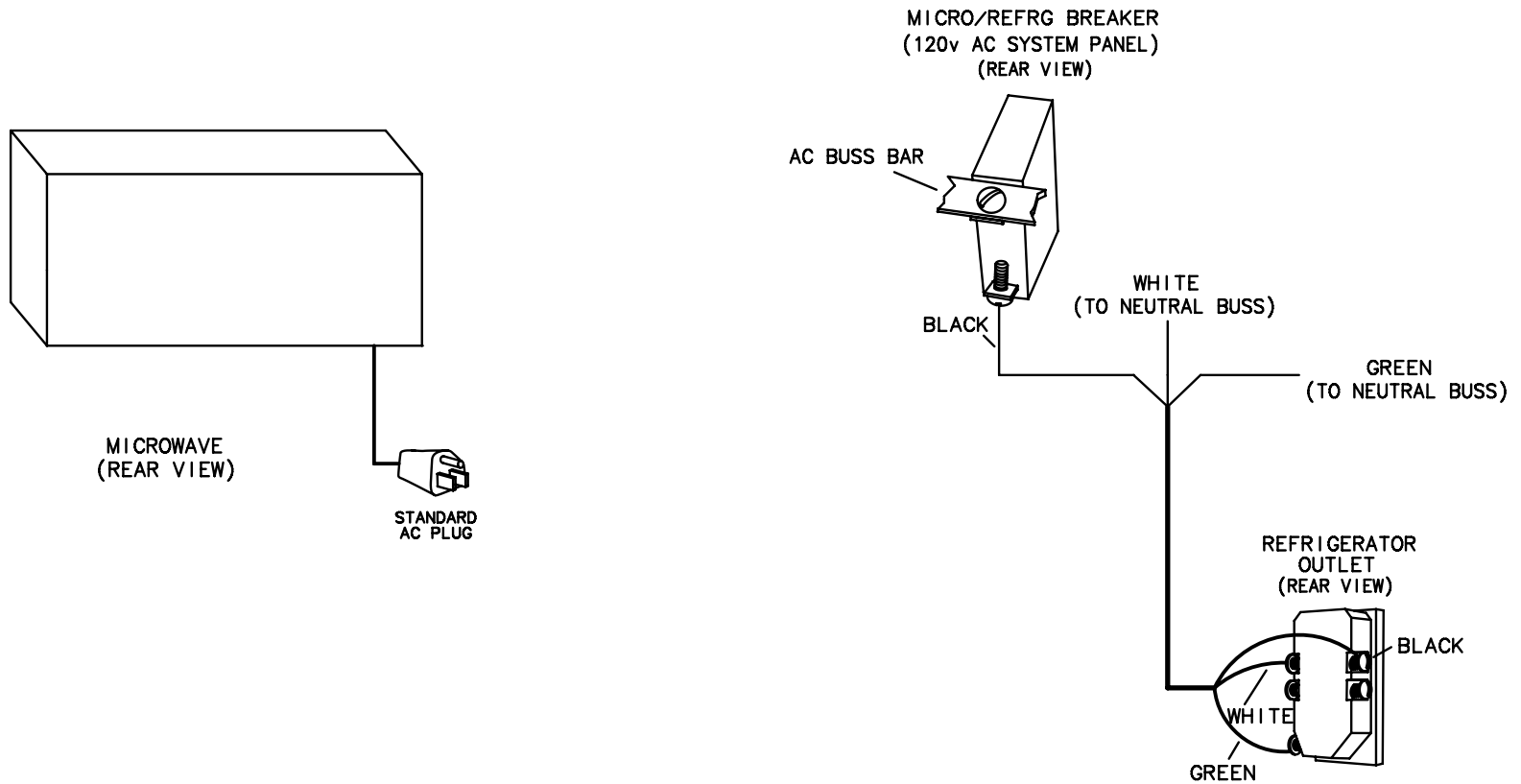

TITLE: MICROWAVE		THUNDERBIRD PRODUCTS	
		P.O. BOX 1003	
MOD.: 330 CBR	DR BY: KPP	DECATUR IN., 46733	
NO.: 13	DATE: 7-1-15	(260) 724-9111	

TO OPERATE:

Connect your extension cord with no AC power present to the ProSport and proceed to plug your extension cord in to a nearby 120 VAC GFCI protected (Ground Fault Circuit Interrupt) outlet.

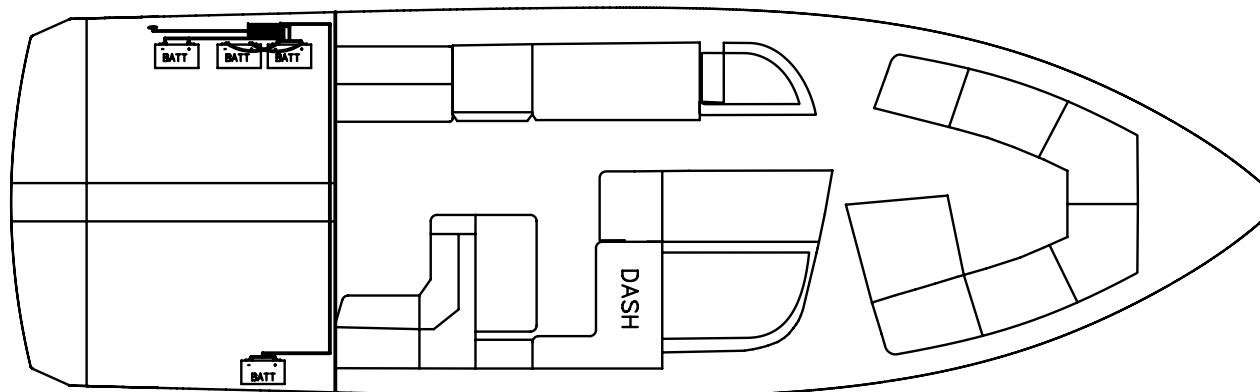
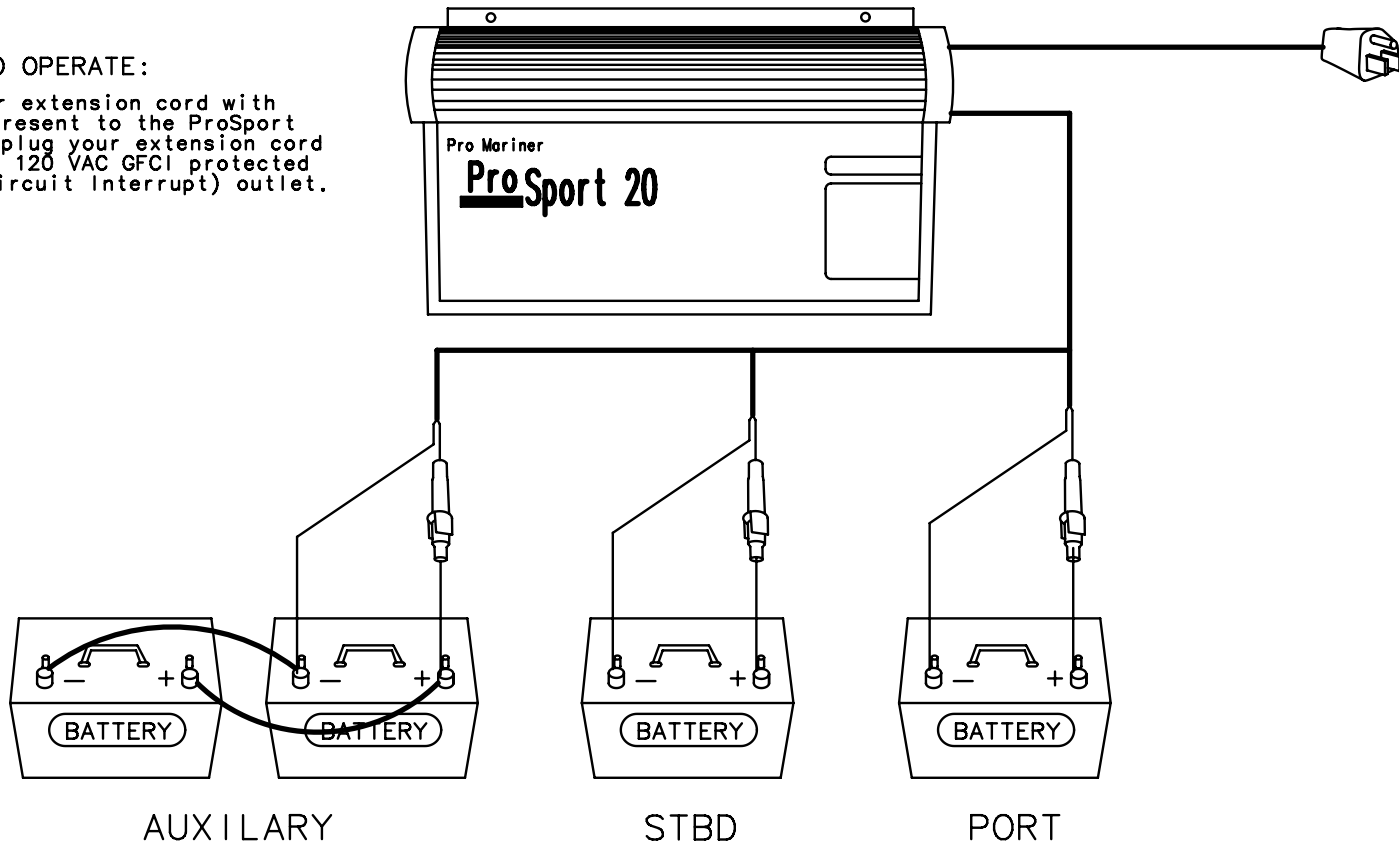

TITLE: PRO MARINER CHARGER		THUNDERBIRD PRODUCTS
		P.O. BOX 1003
MOD.: 330 CBR	DR BY: KPP	DECATUR IN., 46733
NO.: 14	DATE: 7-1-15	(260) 724-9111

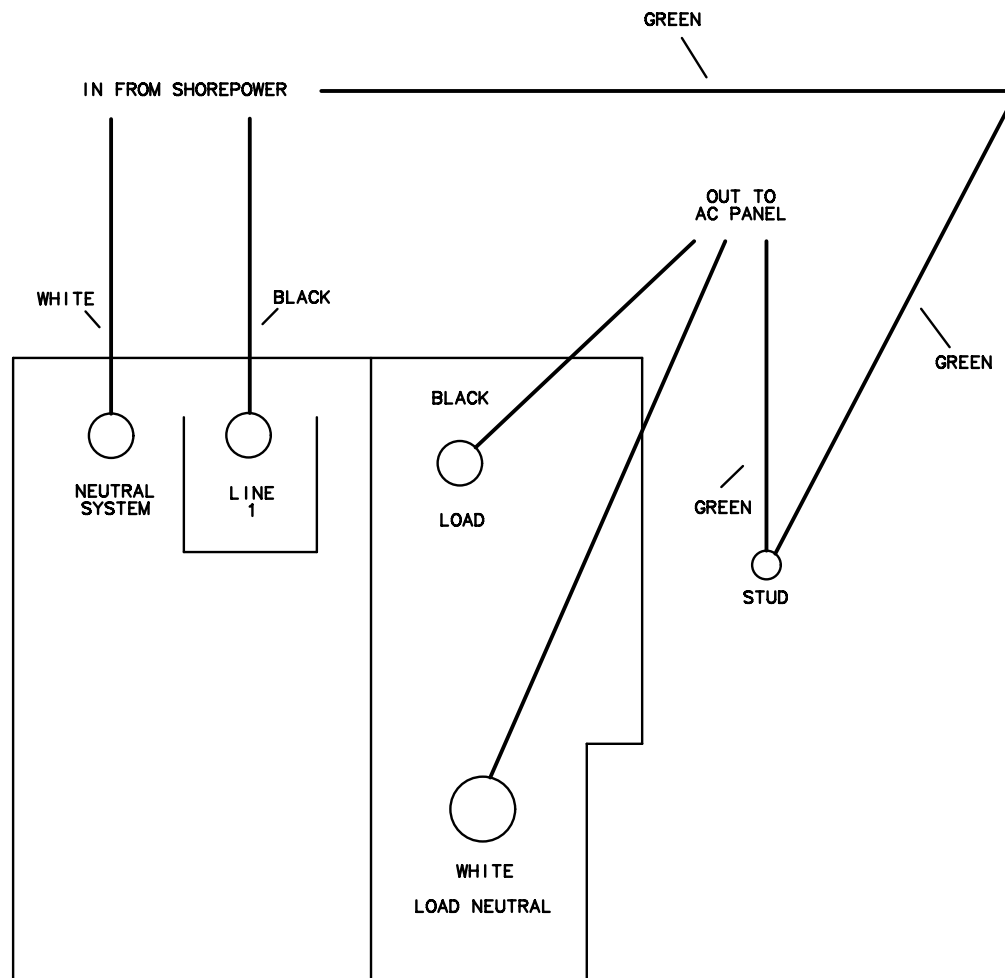

SHOREPOWER ELCI BREAKER
(REAR VIEW)

(LOCATED UNDER THE AFT CORNER
STARBOARD LOUNGE SEAT)

TITLE: SHOREPOWER 120V BREAKER		THUNDERBIRD PRODUCTS
		P.O. BOX 1003
MOD.: 330 CBR	DR BY: KPP	DECATUR IN., 46733
NO.: 15	DATE: 7-1-15	(260) 724-9111

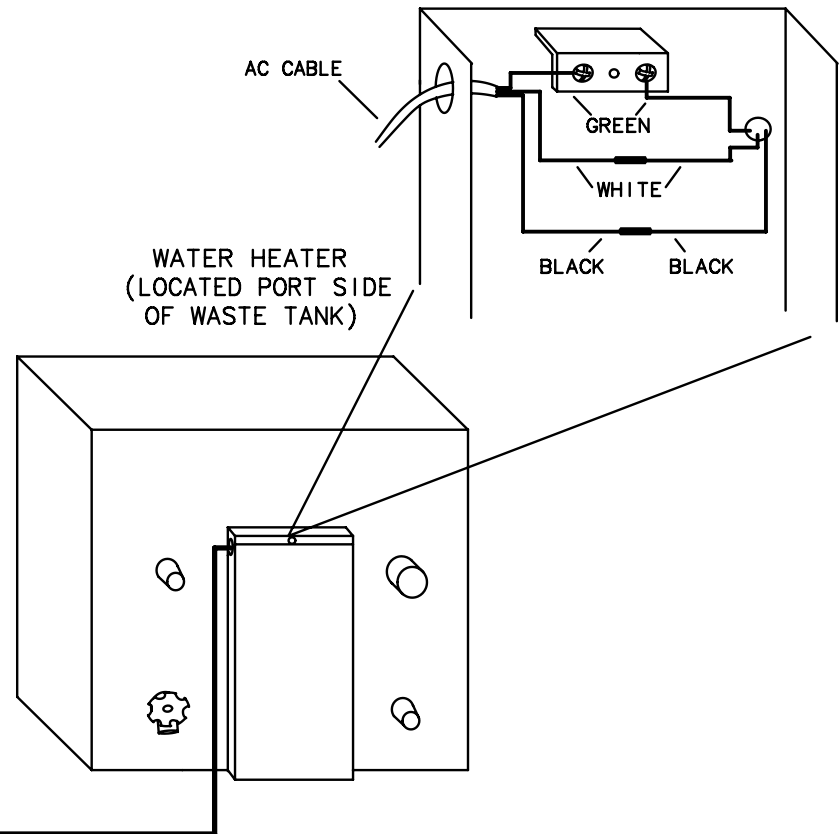
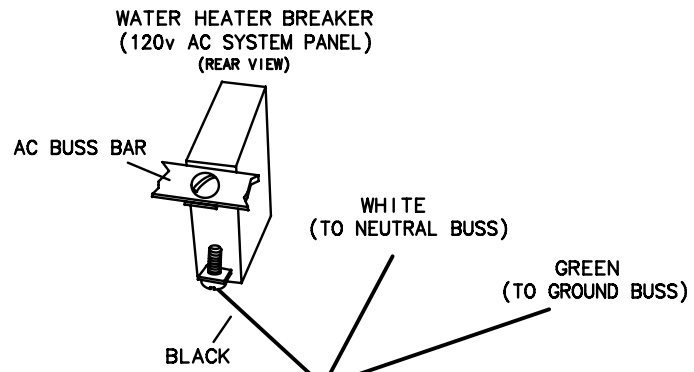

TITLE: WATER HEATER		THUNDERBIRD PRODUCTS
		P.O. BOX 1003
MOD.: 330 CBR	DR BY: KPP	DECATUR IN., 46733
NO.: 16	DATE: 7-1-15	(260) 724-9111

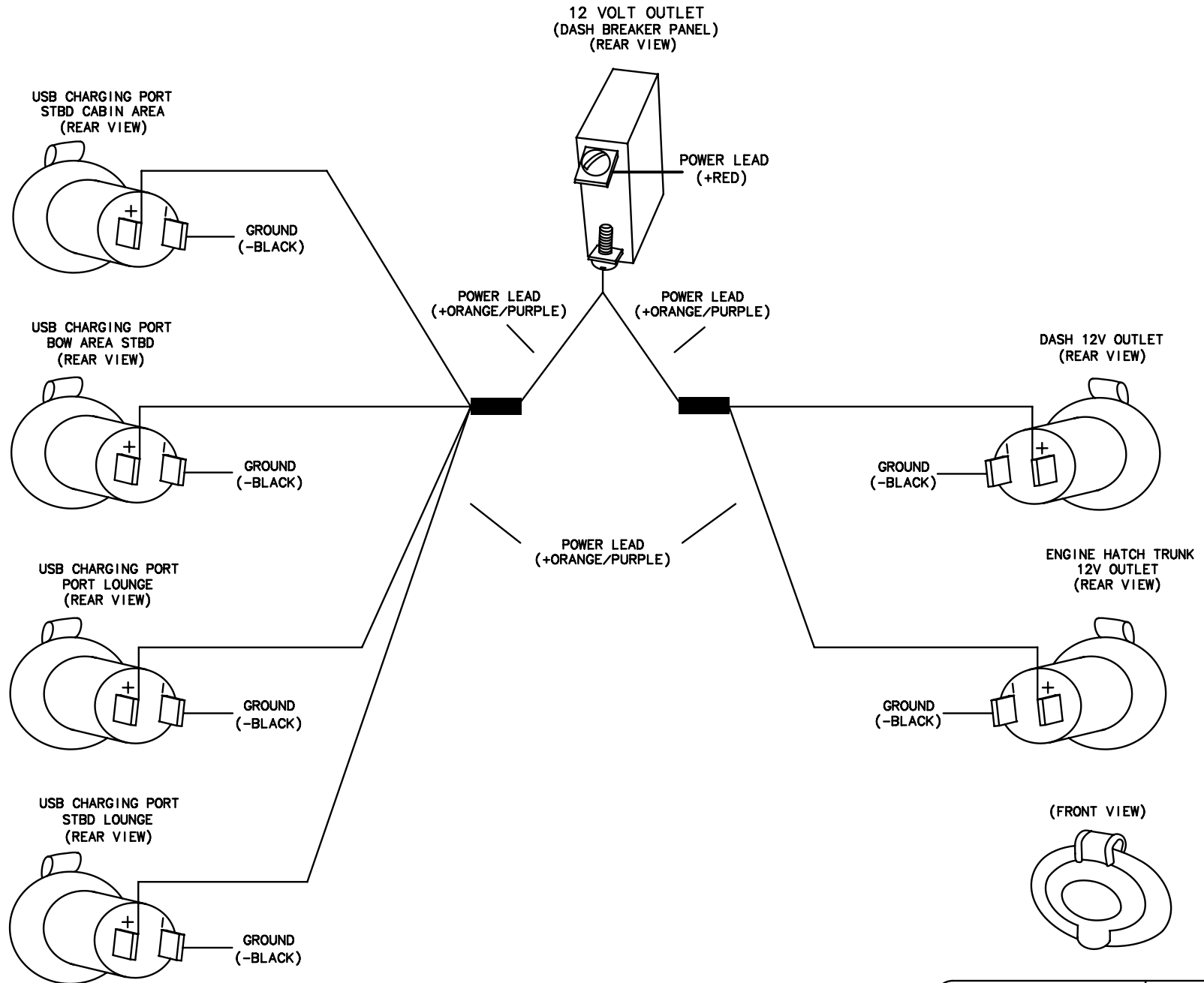

TITLE: 12V AND USB OUTLETS		THUNDERBIRD PRODUCTS
		P.O. BOX 1003
MOD.: 330 CBR	DR BY: KPP	DECATUR IN., 46733
NO.: 17	DATE: 7-1-15	(260) 724-9111

LEGEND

C-BREAKER PANEL	
IGNITION SWITCH	
PLUG INTERCONNECT	
FIRE EXTINGUISH LIGHT	
MANUAL RELEASE LEVER CABLE	
GROUND	

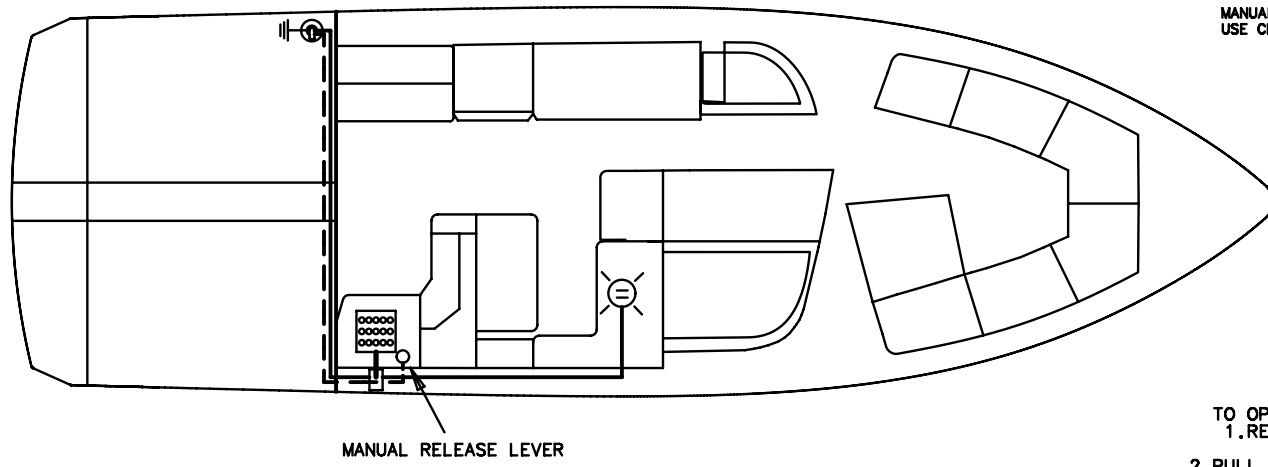

NOTE:
 MANUAL FIRE EXTINGUISHERS
 USE CLEAN AGENT HFC-227ea, DUPONT FM200

- TO OPERATE MANUAL DISCHARGE:**
1. REMOVE PIN LOCATED UNDER THE WET BAR.
 2. PULL RED HANDLE LABELED "FIRE"
 3. SHUT DOWN ENGINES, BLOWERS AND ELECTRICAL SYSTEMS.

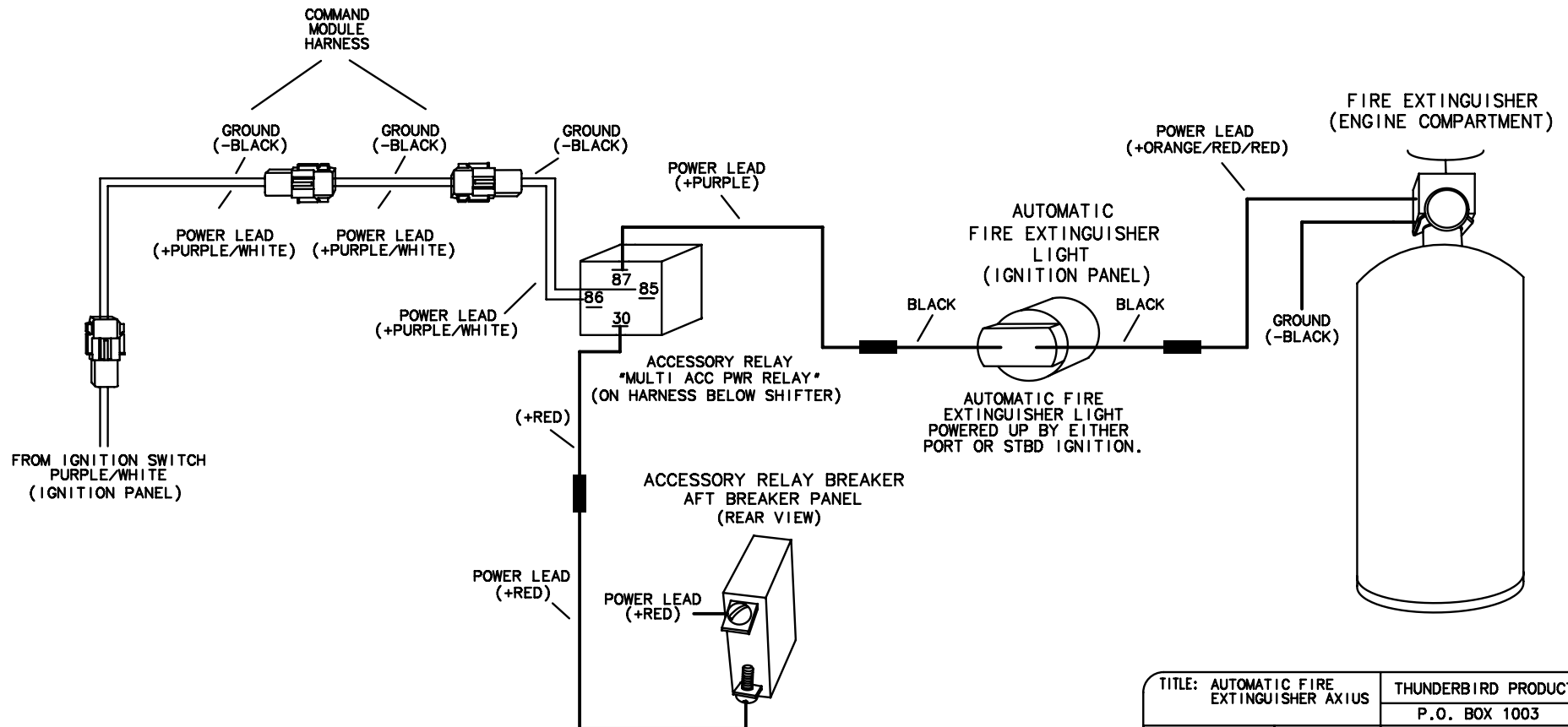

TITLE: AUTOMATIC FIRE EXTINGUISHER AXIUS		THUNDERBIRD PRODUCTS
		P.O. BOX 1003
MOD.: 330 CBR	DR BY: KPP	DECATUR IN., 46733
NO.: 18	DATE: 7-1-15	(260) 724-9111

LEGEND

C-BREAKER PANEL



IGNITION SWITCH

PLUG INTERCONNECT

FIRE EXTINGUISH LIGHT

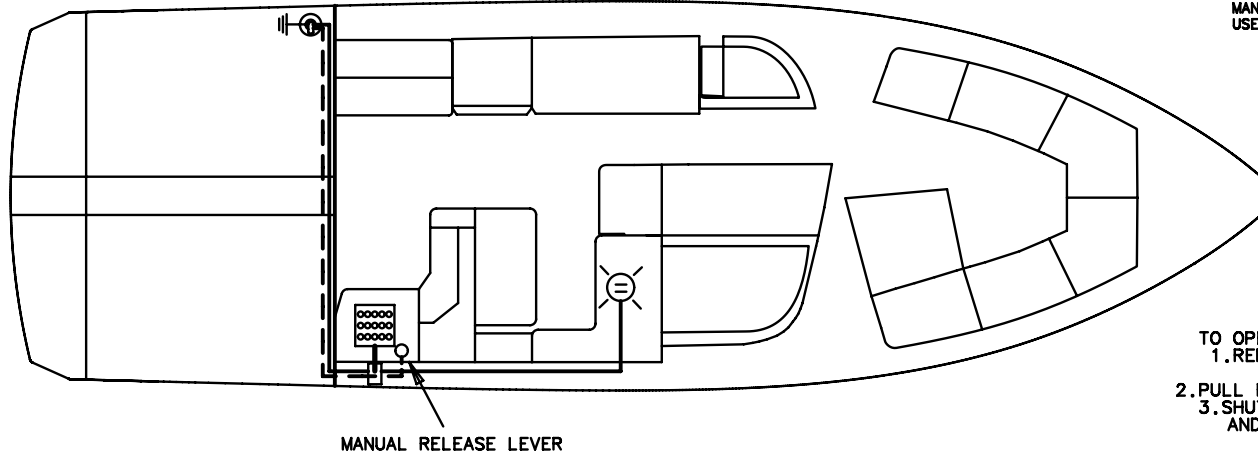

MANUAL RELEASE LEVER CABLE

GROUND

NOTE:
 MANUAL FIRE EXTINGUISHERS
 USE CLEAN AGENT HFC-227ea, DUPONT FM200

- TO OPERATE MANUAL DISCHARGE:
1. REMOVE PIN LOCATED UNDER THE WET BAR.
 2. PULL RED HANDLE LABELED "FIRE"
 3. SHUT DOWN ENGINES, BLOWERS AND ELECTRICAL SYSTEMS.

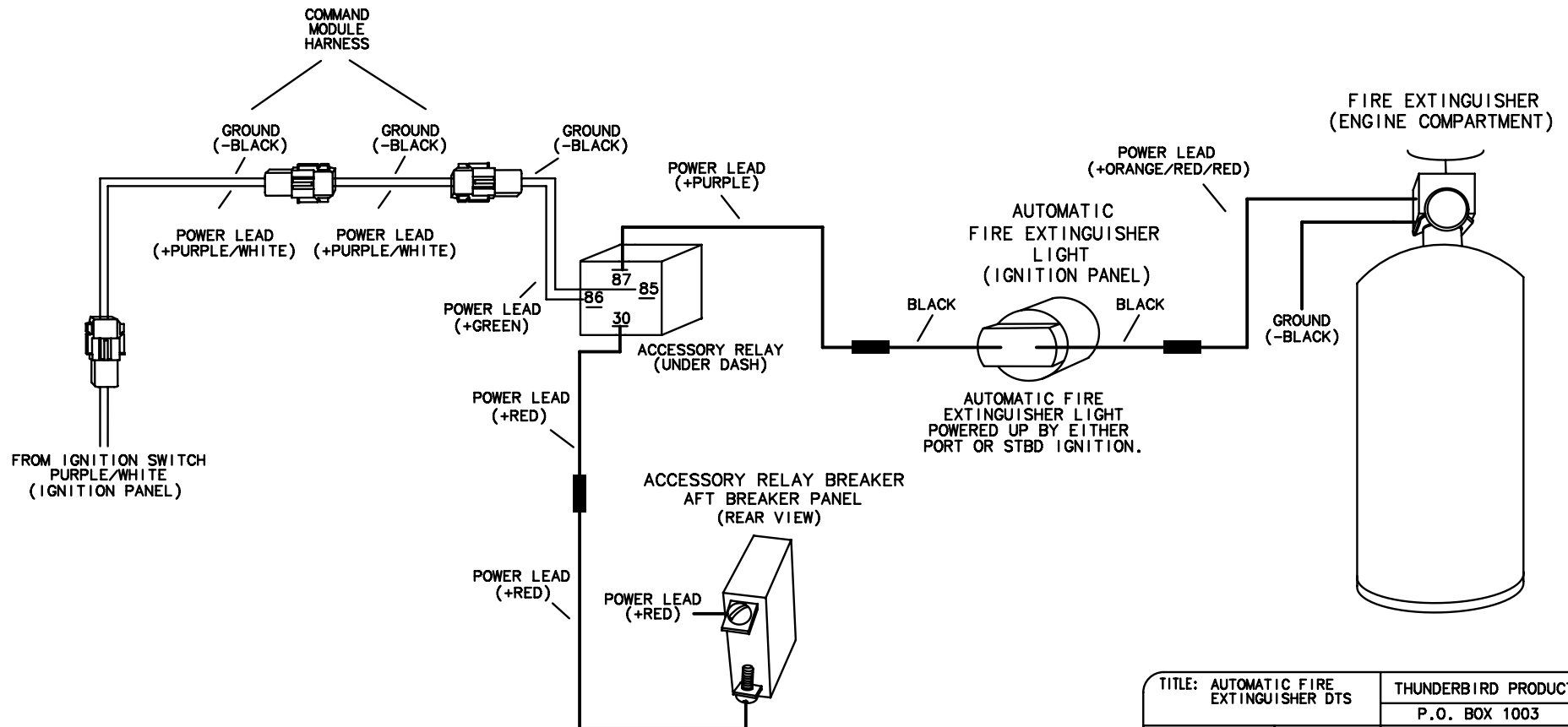

TITLE: AUTOMATIC FIRE EXTINGUISHER DTS		THUNDERBIRD PRODUCTS
		P.O. BOX 1003
MOD.: 330 CBR	DR BY: KPP	DECATUR IN., 46733
NO.: 19	DATE: 7-1-15	(260) 724-9111

LEGEND

C-BREAKER PANEL	
CONNECTOR	
HALON LIGHT	
GROUND	

TO OPERATE MANUAL DISCHARGE:
 1. REMOVE PIN LOCATED UNDER THE WET BAR.
 2. PULL RED HANDLE LABELED "FIRE"
 3. SHUT DOWN ENGINES, BLOWERS AND ELECTRICAL SYSTEMS.

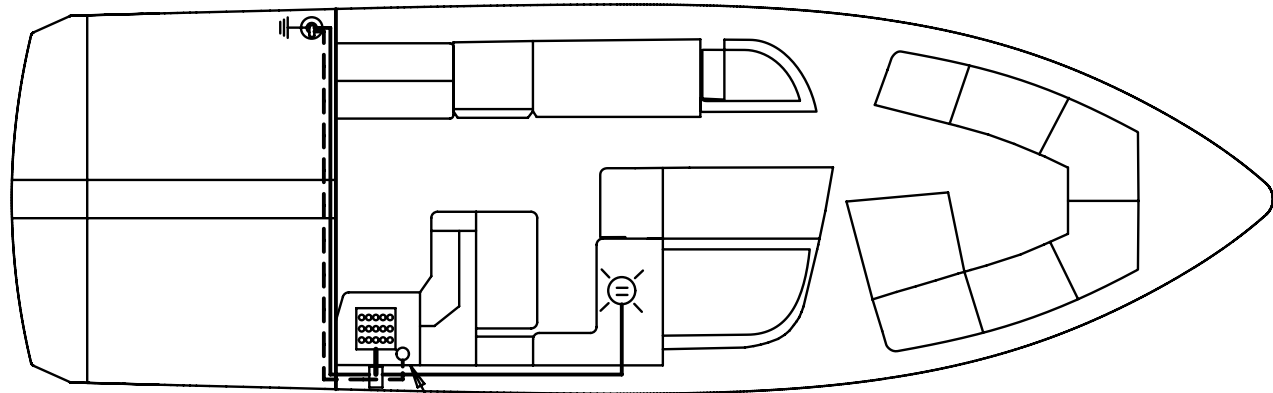

MANUAL RELEASE LEVER

STBD IGNITION BREAKER
 (DASH BREAKER PANEL)
 (REAR VIEW)

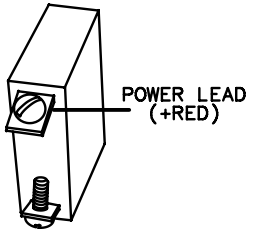

KILL SWITCH
 (LOCATED BELOW THROTTLE)
 (REAR VIEW)

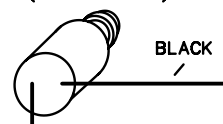

FIRE EXTINGUISHER LIGHT
 (IGNITION PANEL)

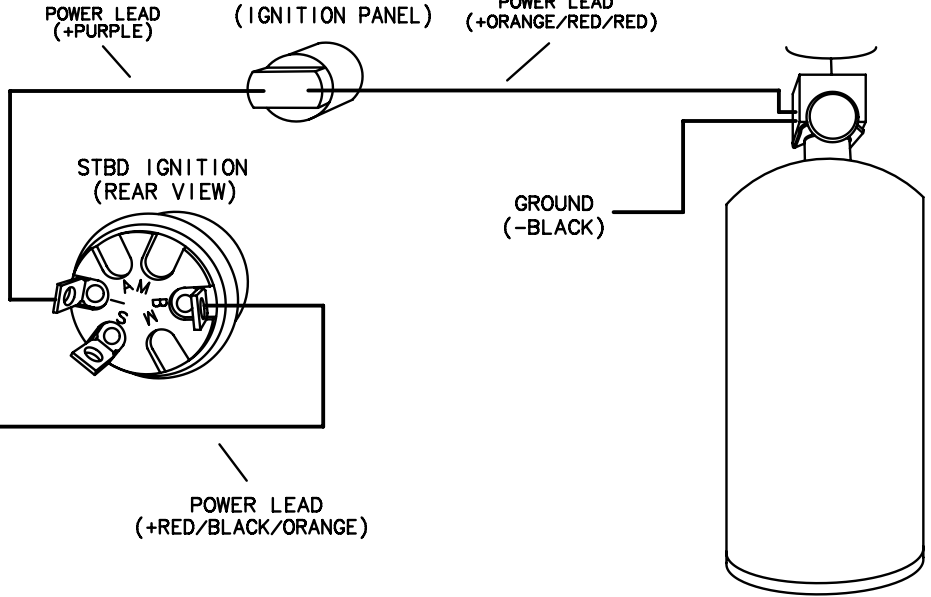

FIRE EXTINGUISHER
 (ENGINE COMPARTMENT)

TITLE: AUTOMATIC FIRE EXTINGUISHER STANDARD		THUNDERBIRD PRODUCTS
		P.O. BOX 1003
MOD.: 330 CBR	DR BY: KPP	DECATUR IN., 46733
NO.: 20	DATE: 7-1-15	(260) 724-9111

LEGEND

C-BREAKER PANEL



BLOWER



PLUG INTERCONNECT



BLOWER HOSE



GROUND

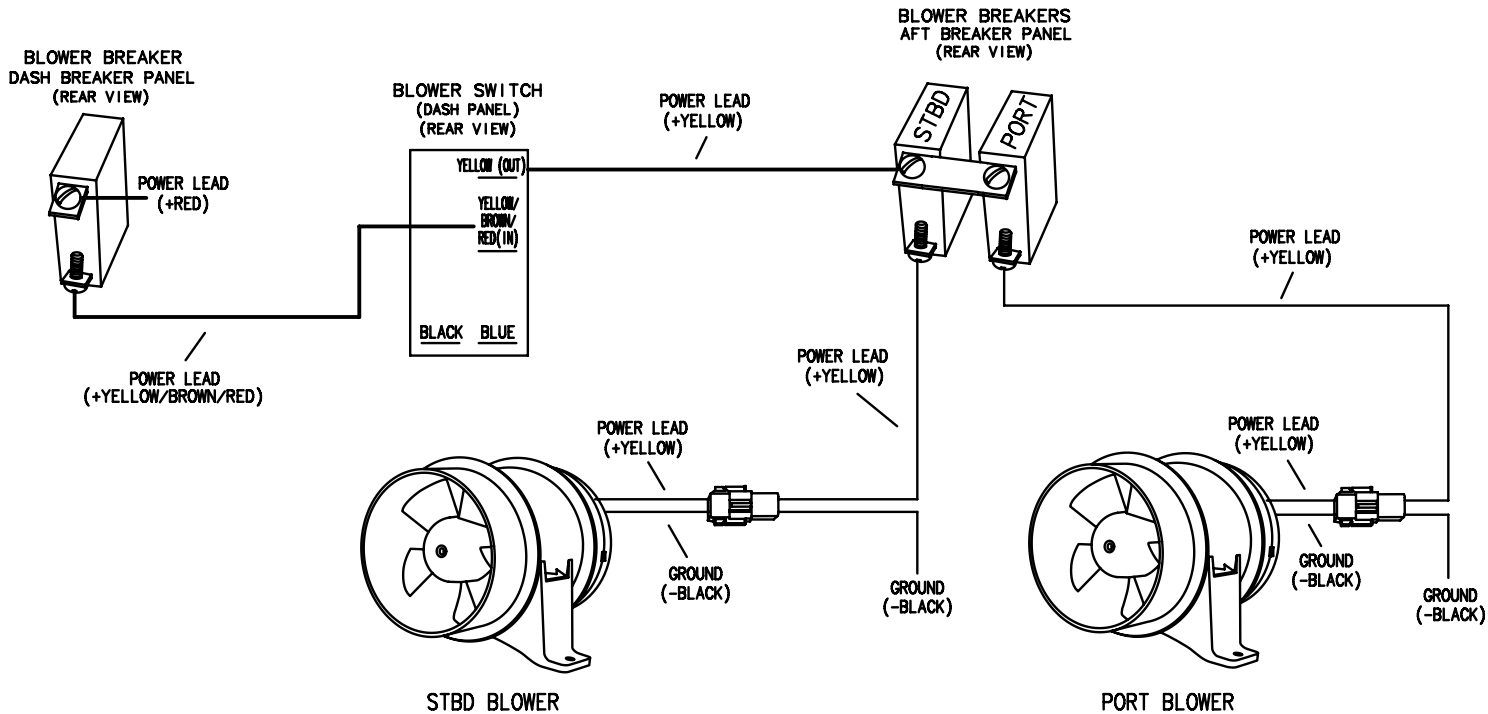

NOTE: STBD BLOWER HOSE RUNS FROM BLOWER LOCATED ON PORT SIDE TO THE STBD SIDE.

WARNING:
GASOLINE VAPORS CAN EXPLODE BEFORE STARTING ENGINE:
-CHECK ENGINE COMPARTMENT FOR GASOLINE VAPORS.
-OPERATE BLOWERS FOR 4 MINUTES.
RUN BLOWER BELOW CRUISING SPEED.

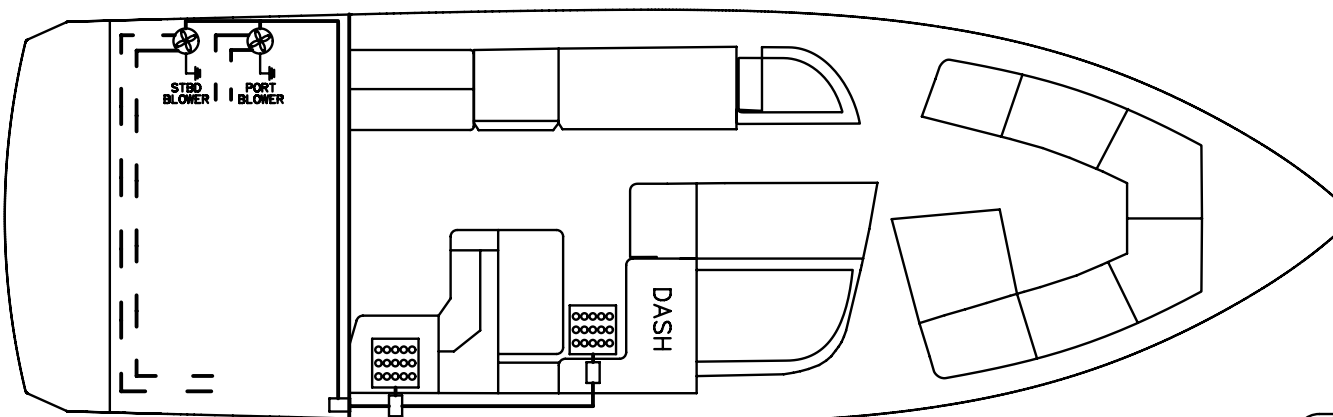

TITLE: BILGE BLOWERS		THUNDERBIRD PRODUCTS	
		P.O. BOX 1003	
MOD.: 330 CBR	DR BY: KPP	DECATUR IN., 46733	
NO.: 21	DATE: 7-1-15	(260) 724-9111	

LEGEND

C-BREAKER PANEL 

PLUG INTERCONNECT 

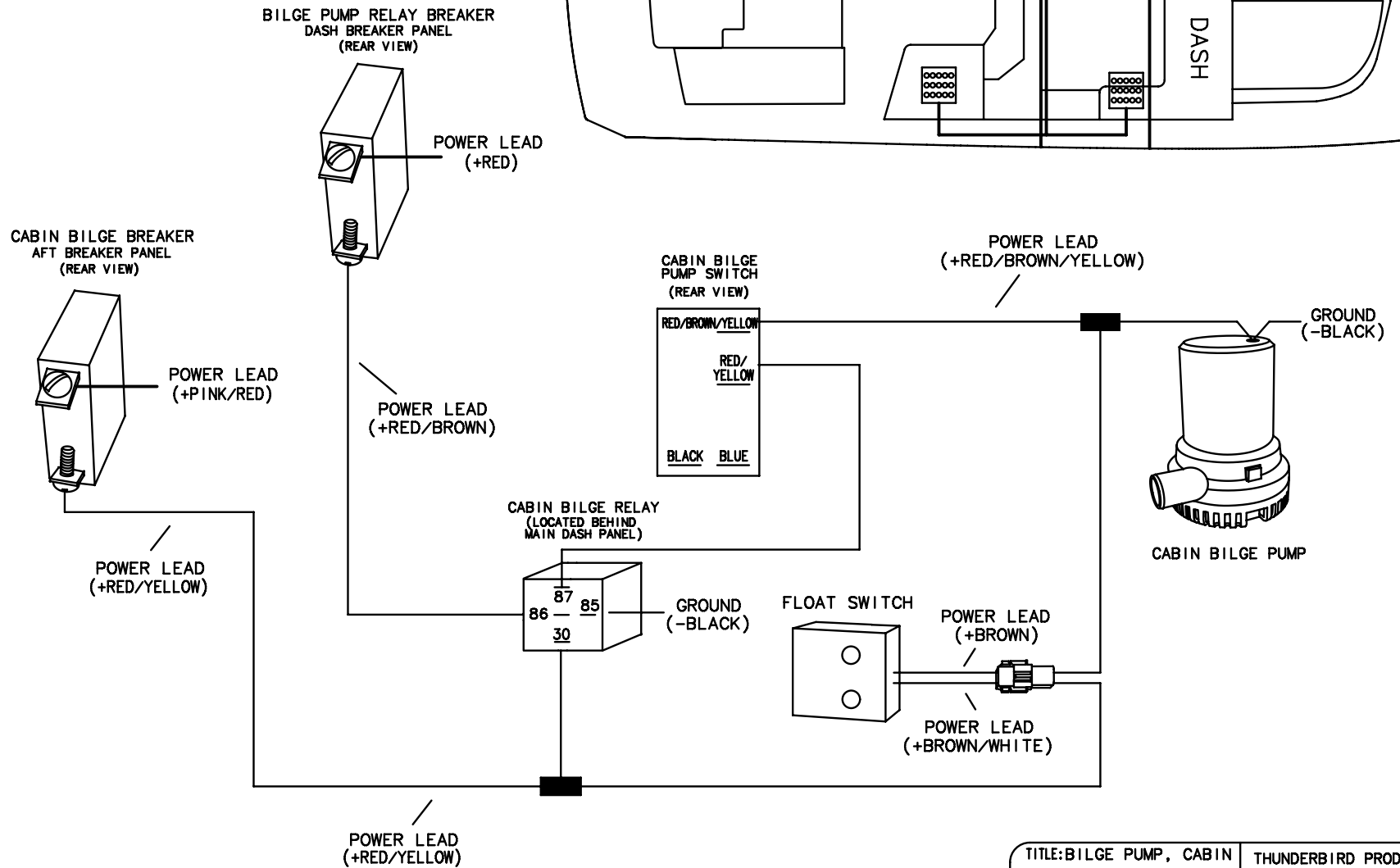
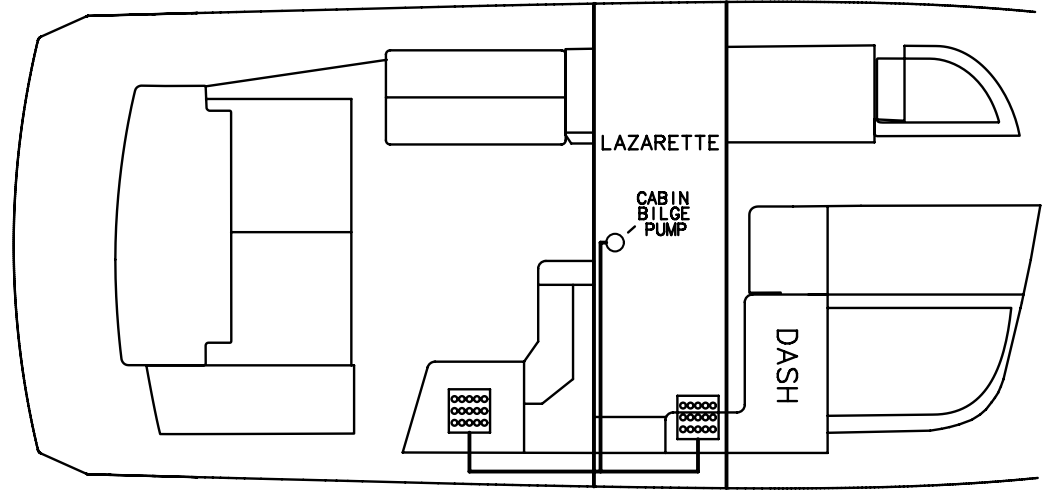

TITLE: BILGE PUMP, CABIN		THUNDERBIRD PRODUCTS
		P.O. BOX 1003
MOD.: 330 CBR	DR BY: KPP	DECATUR IN., 46733
NO.: 22	DATE: 7-1-15	(260) 724-9111

LEGEND

C-BREAKER PANEL 

MOTOR 

PLUG INTERCONNECT 

GROUND 

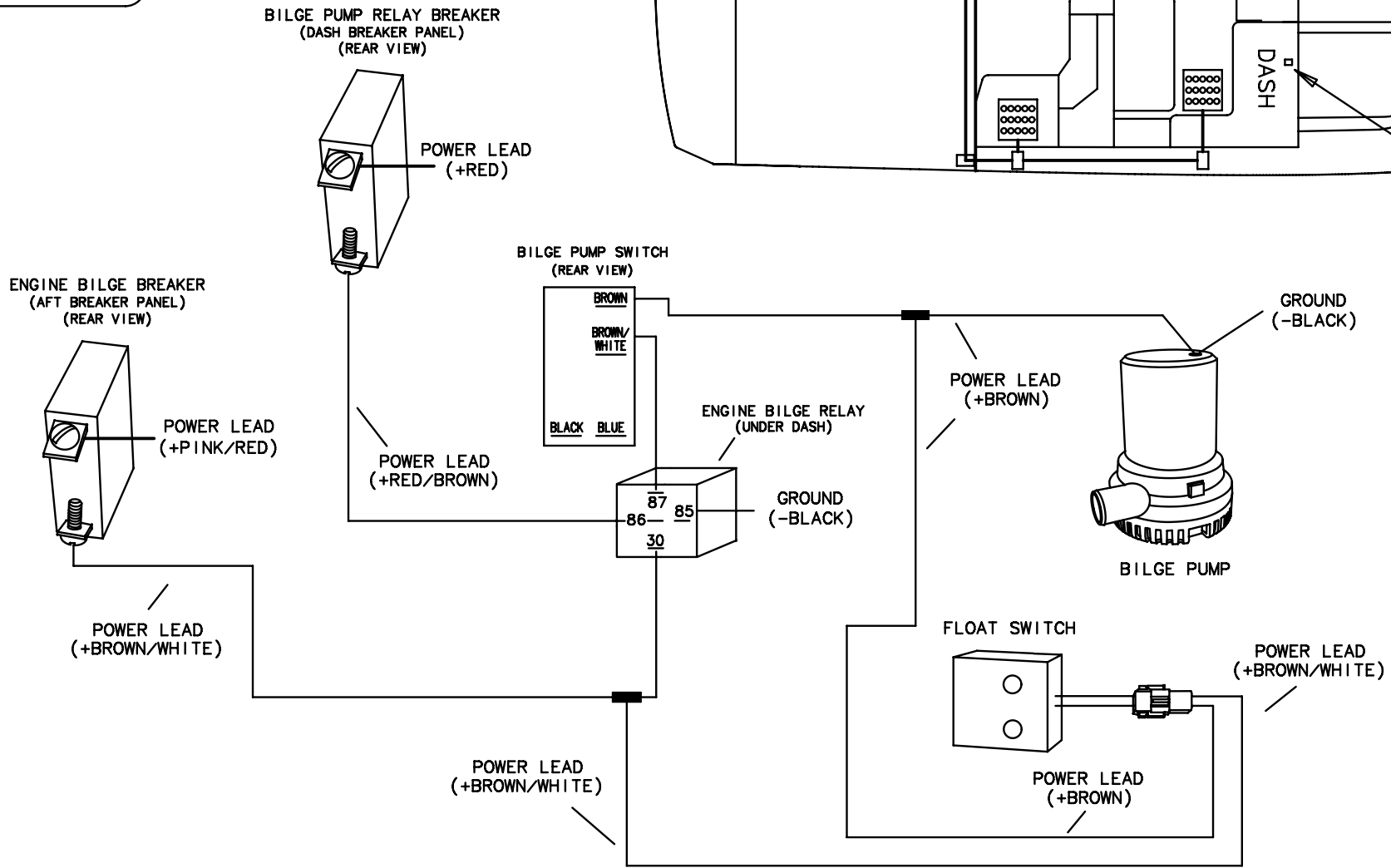
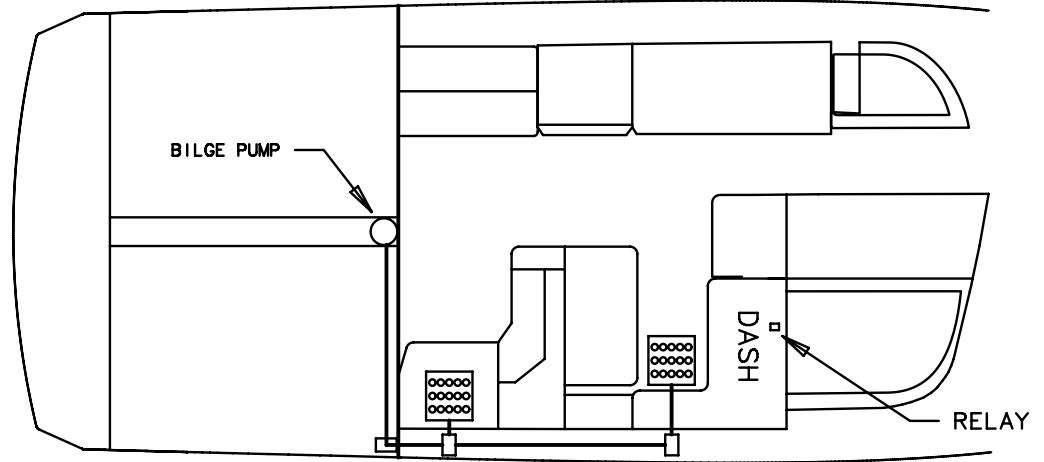

TITLE: BILGE PUMP, ENGINE		THUNDERBIRD PRODUCTS
		P.O. BOX 1003
MOD.: 330 CBR	DR BY: KPP	DECATUR IN., 46733
NO.: 23	DATE: 7-1-15	(260) 724-9111

NOTE:
ALL BONDING WIRES ARE LIGHT GREEN.

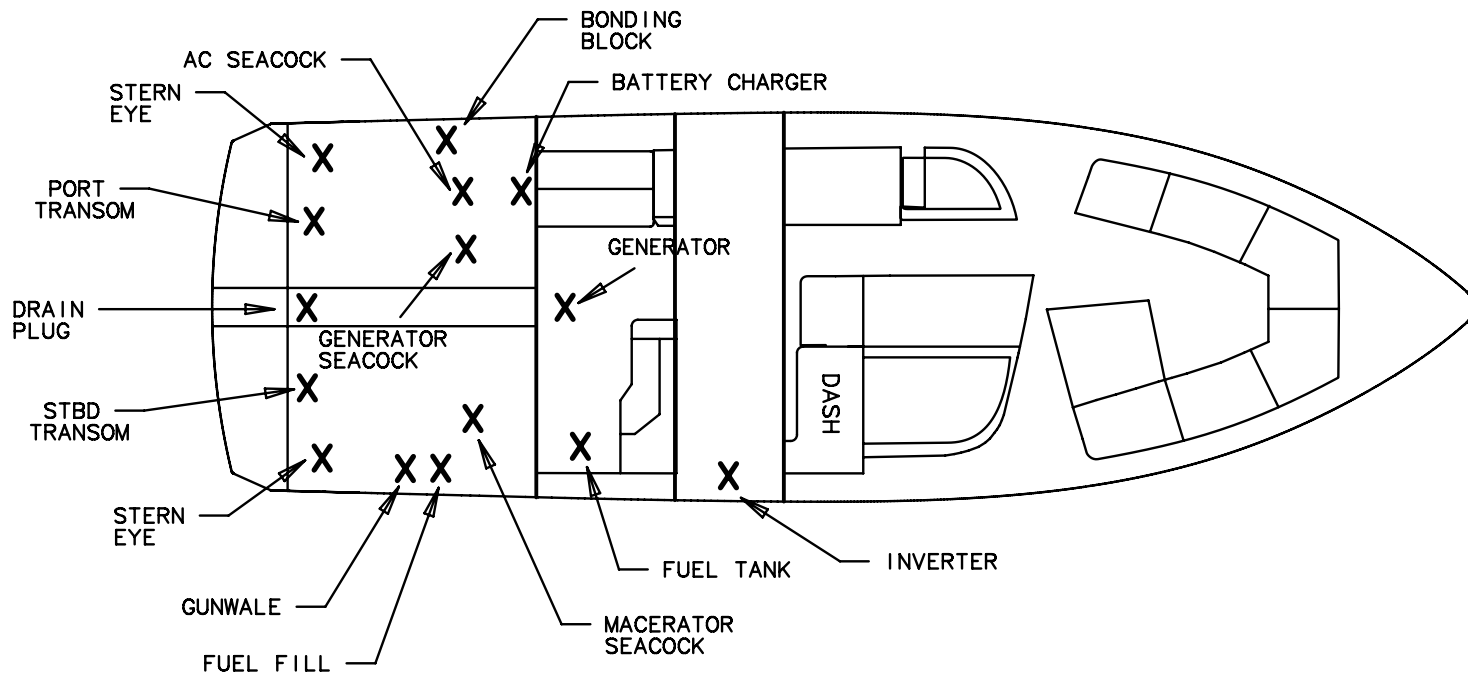

TITLE: BONDING		THUNDERBIRD PRODUCTS
		P.O. BOX 1003
MOD.: 330 CBR	DR BY: KPP	DECATUR IN., 46733
NO.: 24	DATE: 7-1-15	(260) 724-9111

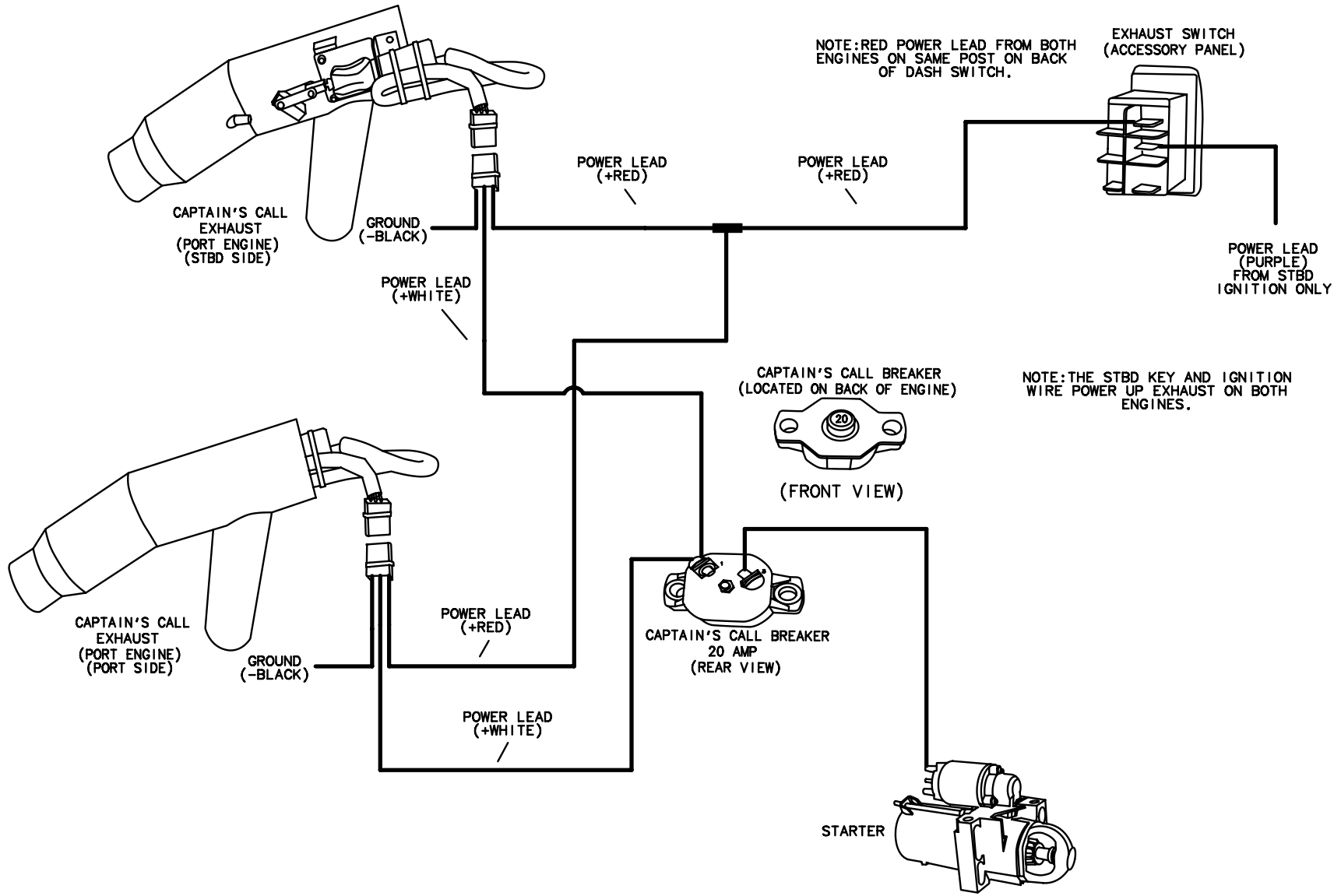

TITLE: CAPTAIN'S CALL NON-DTS PORT ENG		THUNDERBIRD PRODUCTS P.O. BOX 1003
MOD.: 330 CBR	DR BY: KPP	DECATUR IN., 46733
NO.: 25	DATE: 7-1-15	(260) 724-9111

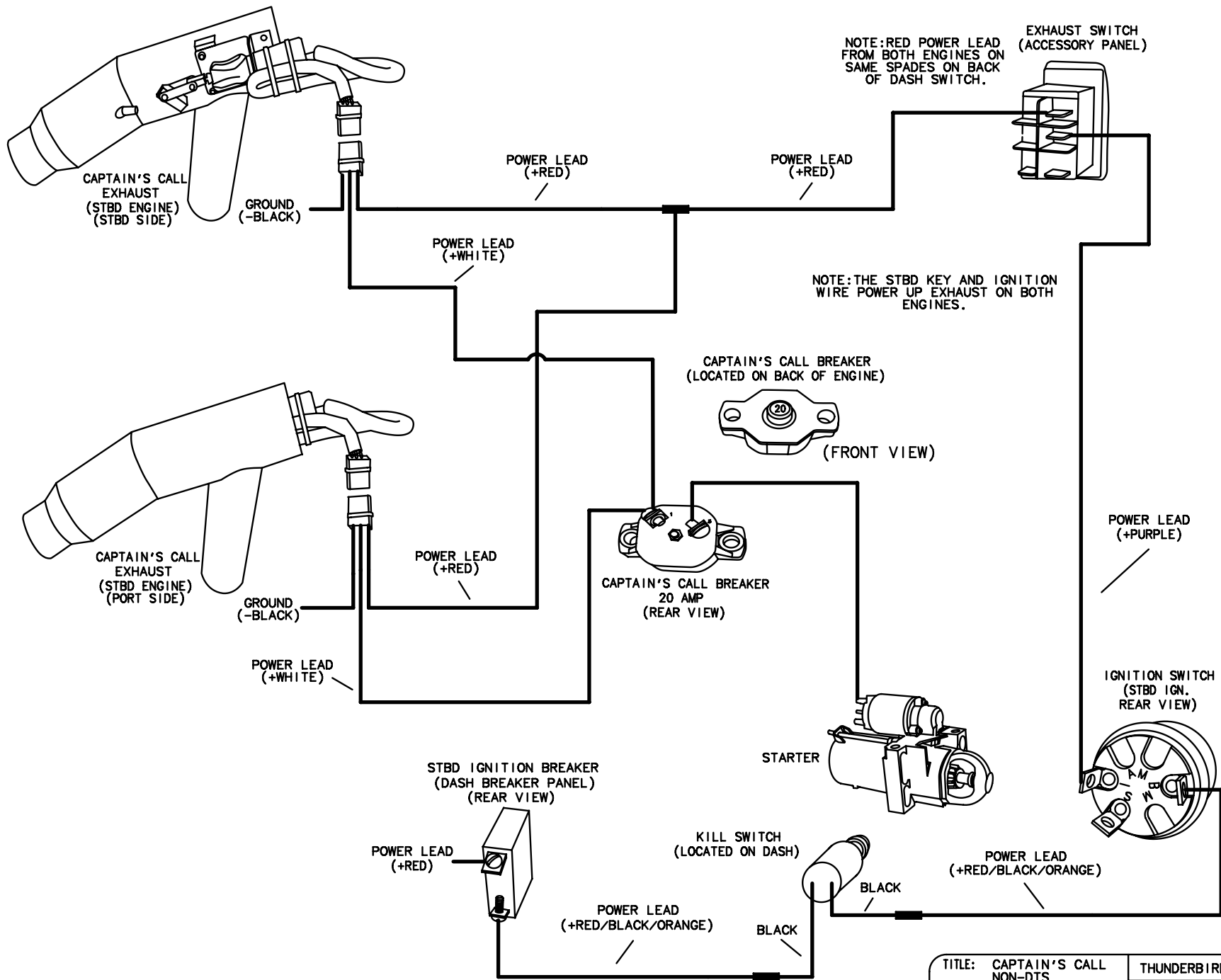

TITLE: CAPTAIN'S CALL NON-DTS STBD ENG		THUNDERBIRD PRODUCTS
		P.O. BOX 1003
MOD.: 330 CBR	DR BY: KPP	DECATUR IN., 46733
NO.: 26	DATE: 7-1-15	(260) 724-9111

LEGEND

BREAKER PANEL 

PLUG INTERCONNECT 

GROUND 

CARBON MONOXIDE DETECTOR 

CABIN DC PANEL 

CO DETECTOR BREAKER
(CABIN 12V BREAKER PANEL)
(REAR VIEW)

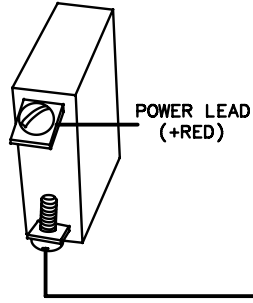

CO DETECTOR
(REAR VIEW)

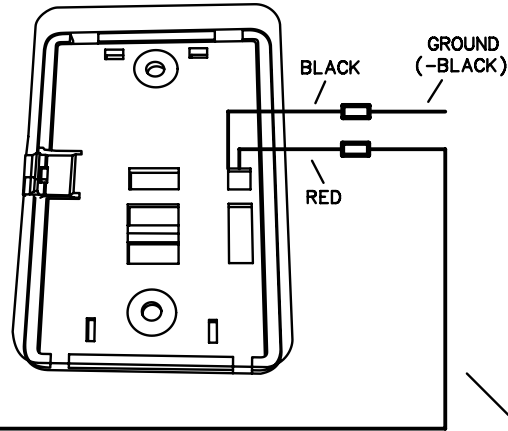

CO DETECTOR
(FRONT VIEW)

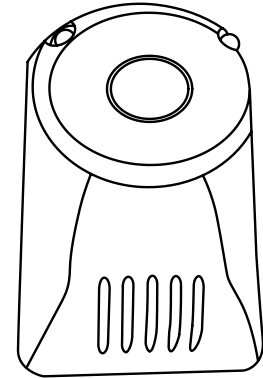

POWER LEAD
(+ORANGE/BROWN)

POWER LEAD
(+ORANGE/BROWN)

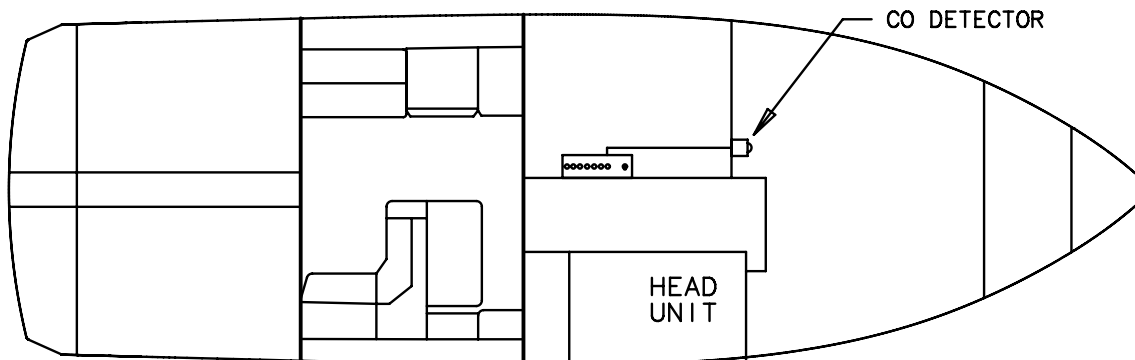

TITLE: CARBON MONOXIDE DETECTOR		THUNDERBIRD PRODUCTS
		P.O. BOX 1003
MOD.: 330 CBR	DR BY: KPP	DECATUR IN., 46733
NO.: 27	DATE: 7-1-15	(260) 724-9111

LEGEND

C-BREAKER PANEL 

PLUG INTERCONNECT 

SUPPLY HOSE 

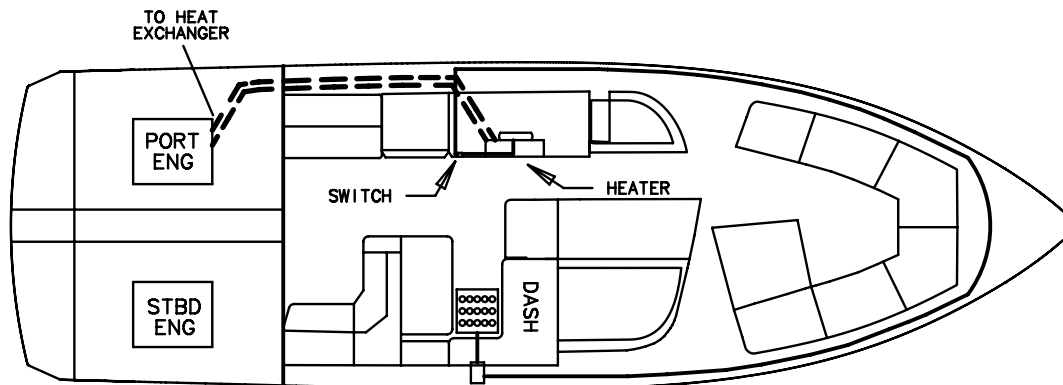
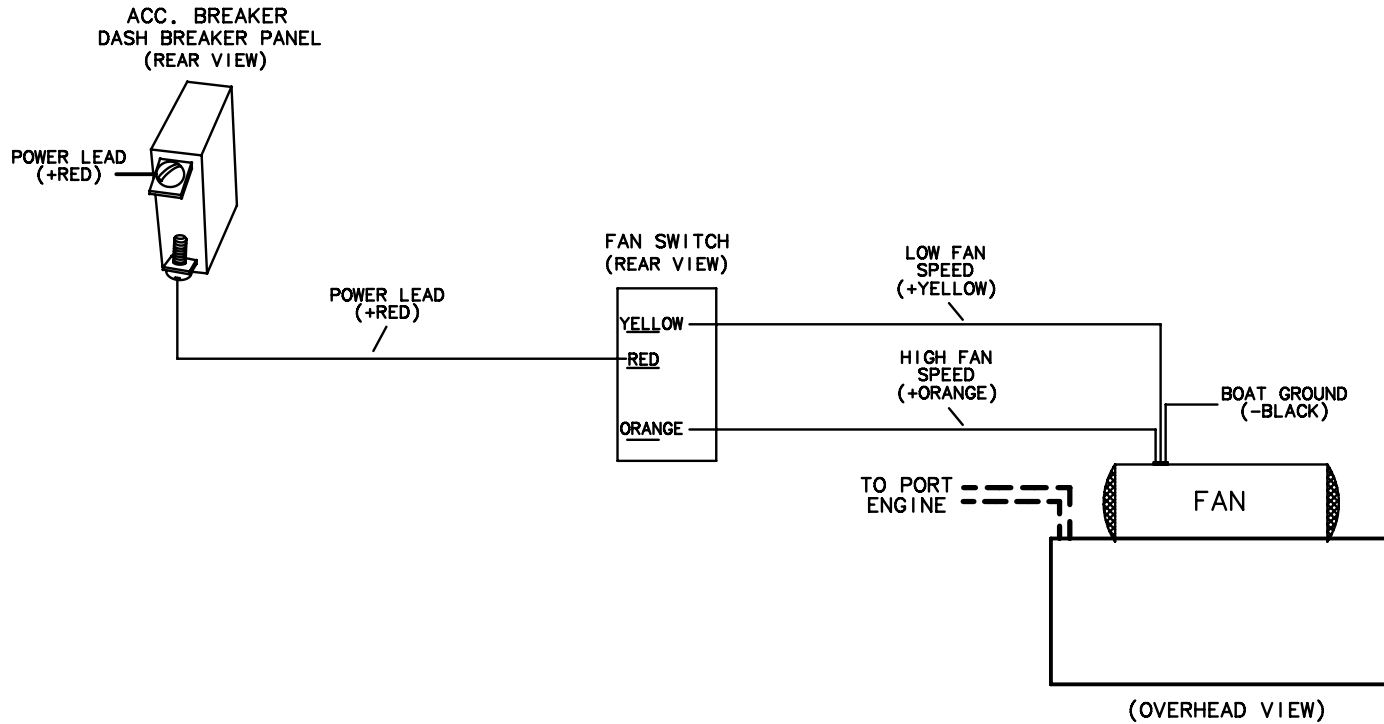

NOTE: WITH WATER HEATER OPTION, SUPPLY HOSE COMES FROM STARBOARD ENGINE.

TITLE: COCKPIT HEATER		THUNDERBIRD PRODUCTS
		P.O. BOX 1003
MOD.: 330 CBR	DR BY: KPP	DECATUR IN., 46733
NO.: 28	DATE: 7-1-15	(260) 724-9111

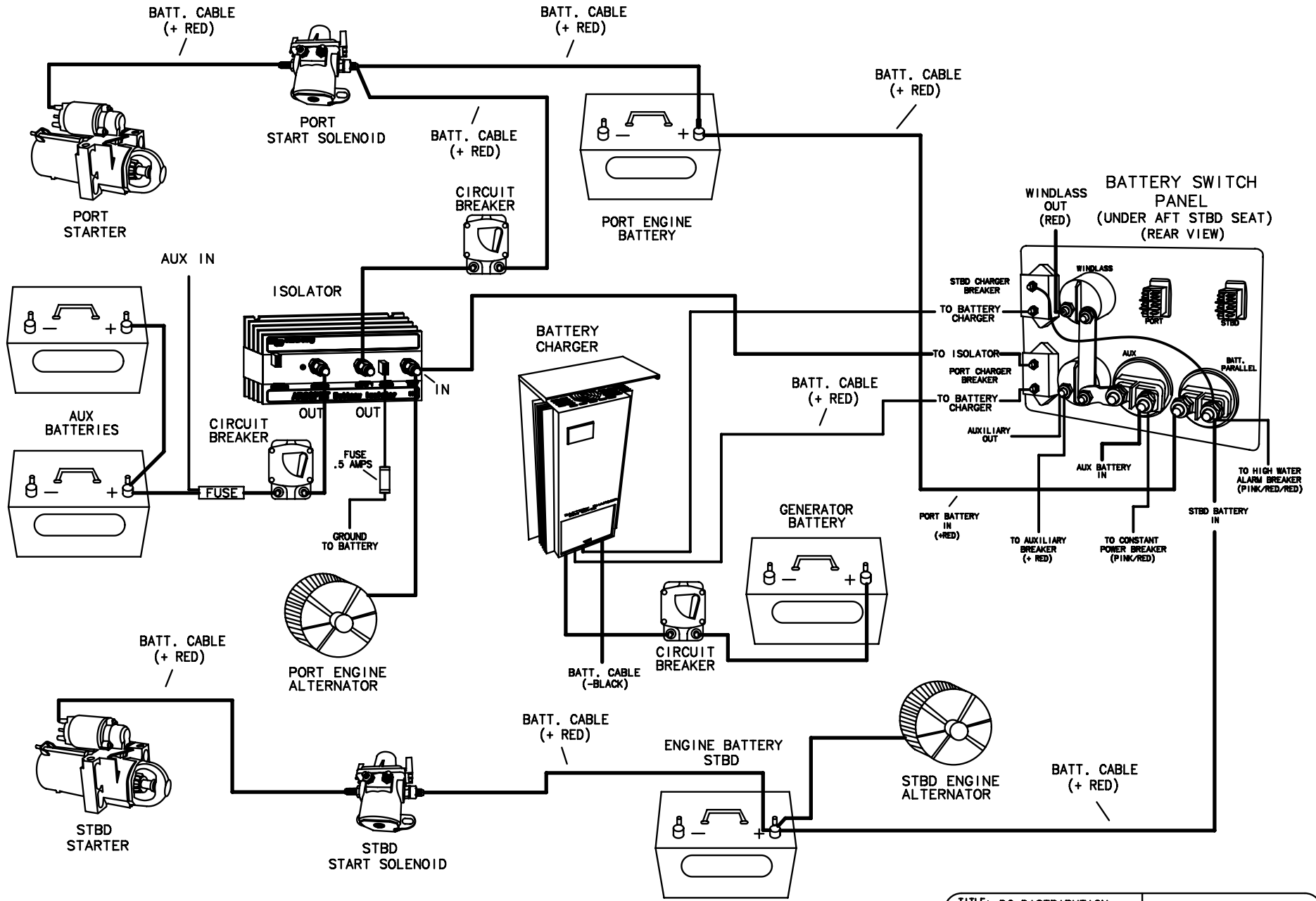

TITLE: DC DISTRIBUTION W/DTS/AXIUS		THUNDERBIRD PRODUCTS
		P.O. BOX 1003
MOD.: 330 CBR	DR BY: KPP	DECATUR IN., 46733
NO.: 29	DATE: 7-1-15	(260) 724-9111

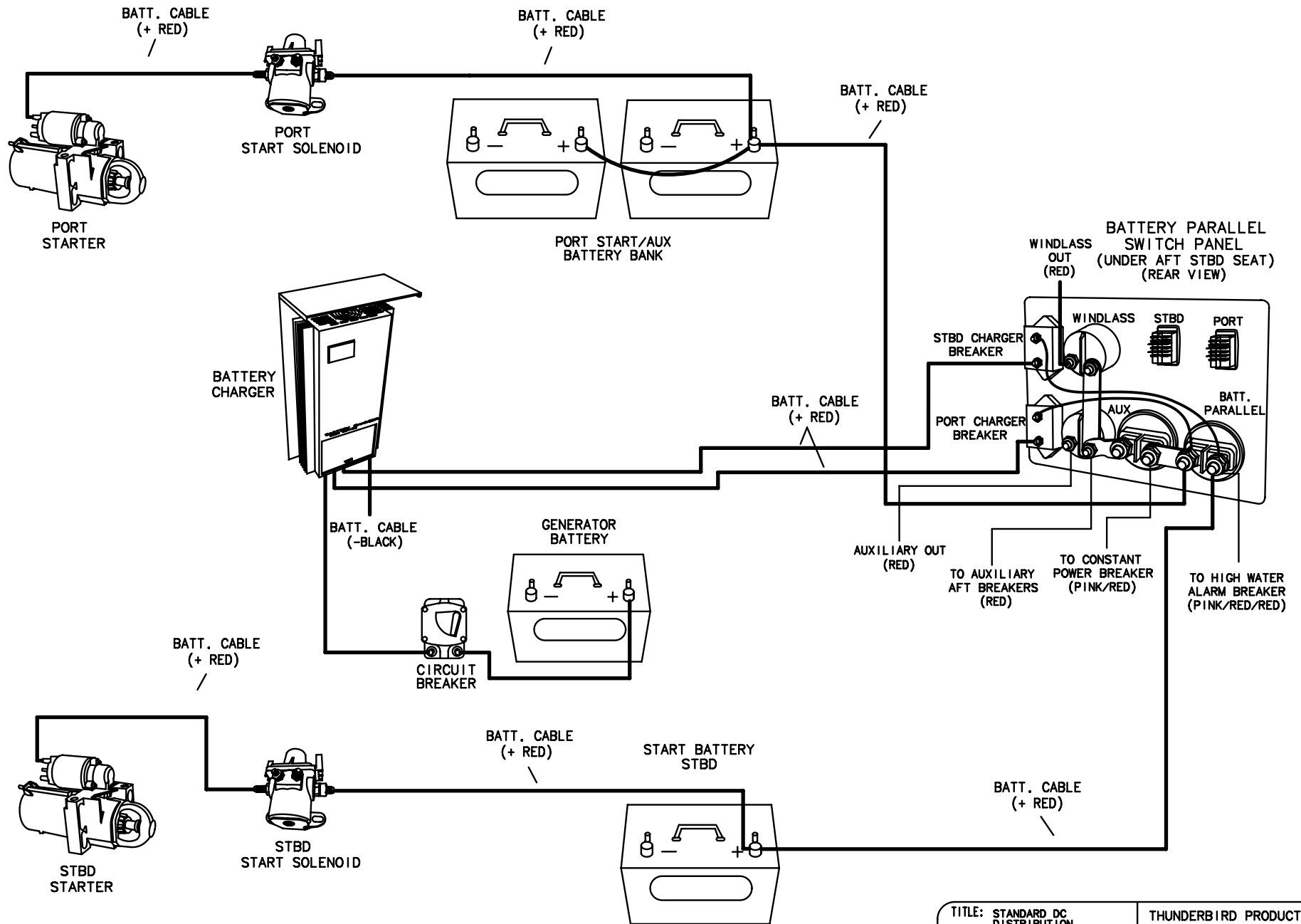

TITLE: STANDARD DC DISTRIBUTION NON-DTS		THUNDERBIRD PRODUCTS
		P.O. BOX 1003
MOD.: 330 CBR	DR BY: KPP	DECATUR IN., 46733
NO.: 30	DATE: 7-1-15	(260) 724-9111

LEGEND

C-BREAKER PANEL 

CONNECTOR 

GROUND 

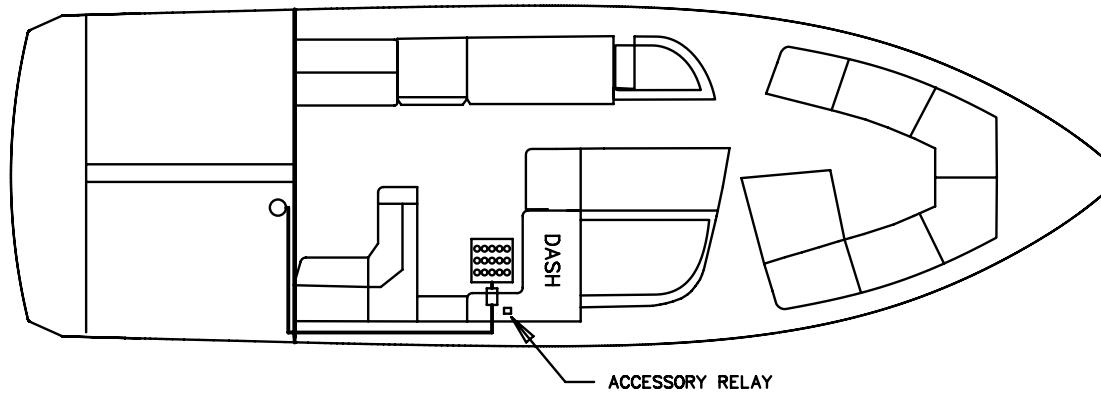

NOTE: CABLE RUNS FROM DEPTH GAUGE TO TRANSDUCER WITH THE DECK HARNESS, THEN THE HULL HARNESS.

RAYMARINE CHARTPLOTTER WILL RUN A CABLE DIRECTLY FROM PLOTTER TO THRU HULL TRANSDUCER IN THE SAME LOCATION AND CABLE ROUTING.

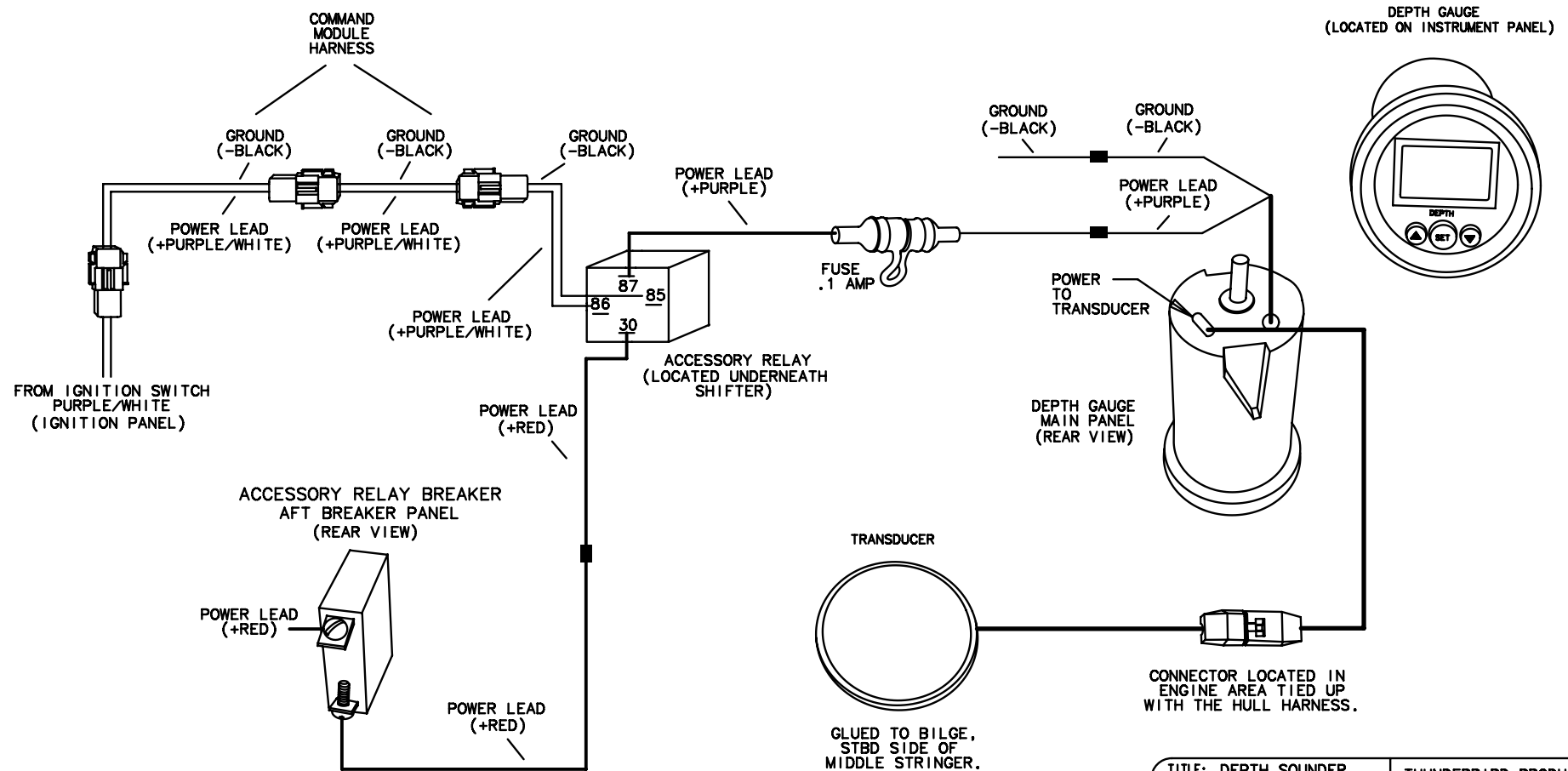

TITLE: DEPTH SOUNDER AXIUS		THUNDERBIRD PRODUCTS
		P.O. BOX 1003
MOD.: 330 CBR	DR BY: KPP	DECATUR IN., 46733
NO.: 31	DATE: 7-1-15	(260) 724-9111

LEGEND

C-BREAKER PANEL 

CONNECTOR 

GROUND 

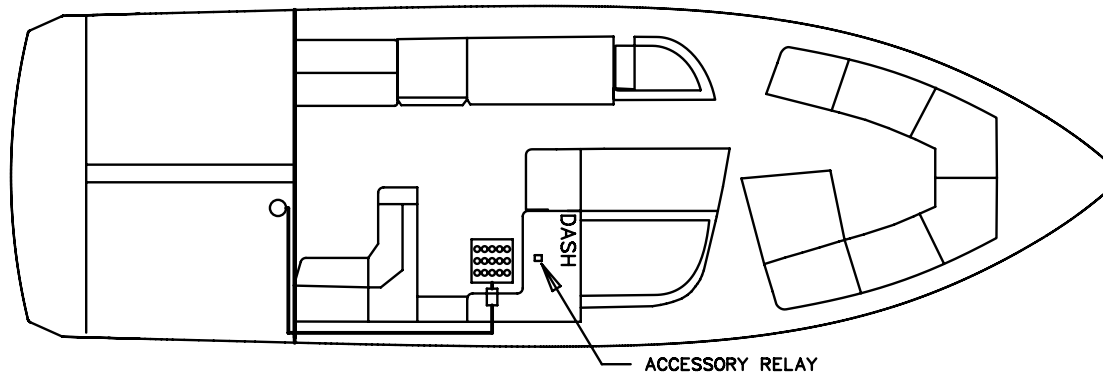

NOTE: CABLE RUNS FROM DEPTH GAUGE TO TRANSDUCER WITH THE DECK HARNESS, THEN THE HULL HARNESS.

RAYMARINE CHARTPLOTTER WILL RUN A CABLE DIRECTLY FROM PLOTTER TO THRU HULL TRANSDUCER IN THE SAME LOCATION AND CABLE ROUTING.

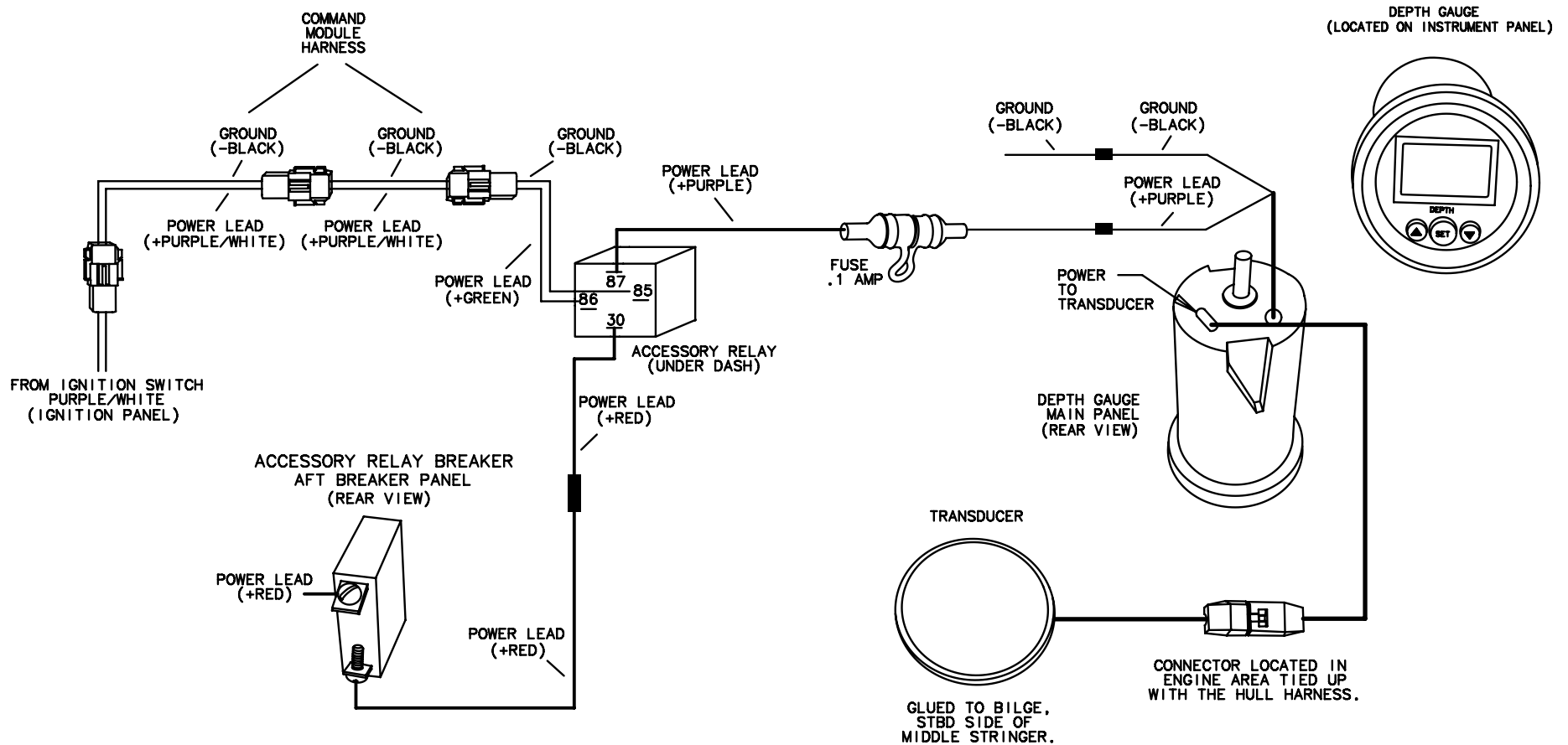

TITLE: DEPTH SOUNDER DTS		THUNDERBIRD PRODUCTS
		P.O. BOX 1003
MOD.: 330 CBR	DR BY: KPP	DECATUR IN., 46733
NO.: 32	DATE: 7-1-15	(260) 724-9111

LEGEND

C-BREAKER PANEL 

PLUG INTERCONNECT 

CONNECTOR 

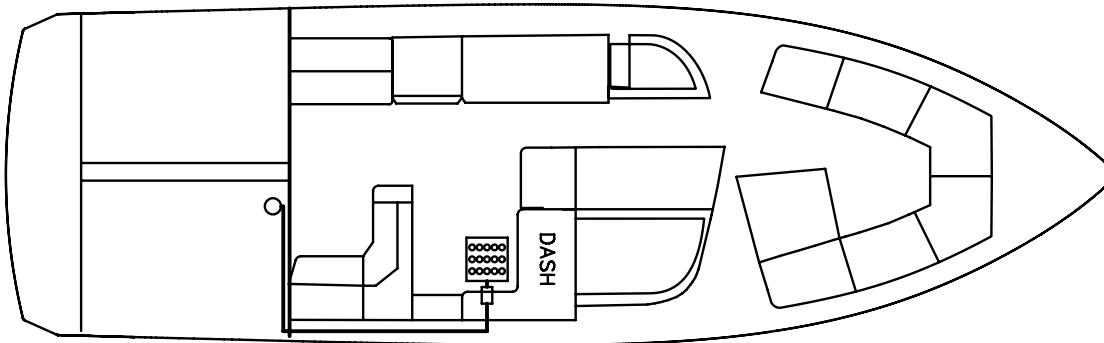

TO OPERATE: TURN ON STBD KEY TO POWER DEPTH SOUNDER. STBD START BATTERY SWITCH MUST BE TURNED ON.

NOTE: CABLE RUNS FROM DEPTH GAUGE TO DEPTH SOUNDER UNIT WITH THE DECK HARNESS, THEN THE HULL HARNESS.

RAYMARINE CHARTPLOTTER WILL RUN A CABLE DIRECTLY FROM PLOTTER TO THRU HULL TRANSUDCER IN THE SAME LOCATION AND CABLE ROUTING.

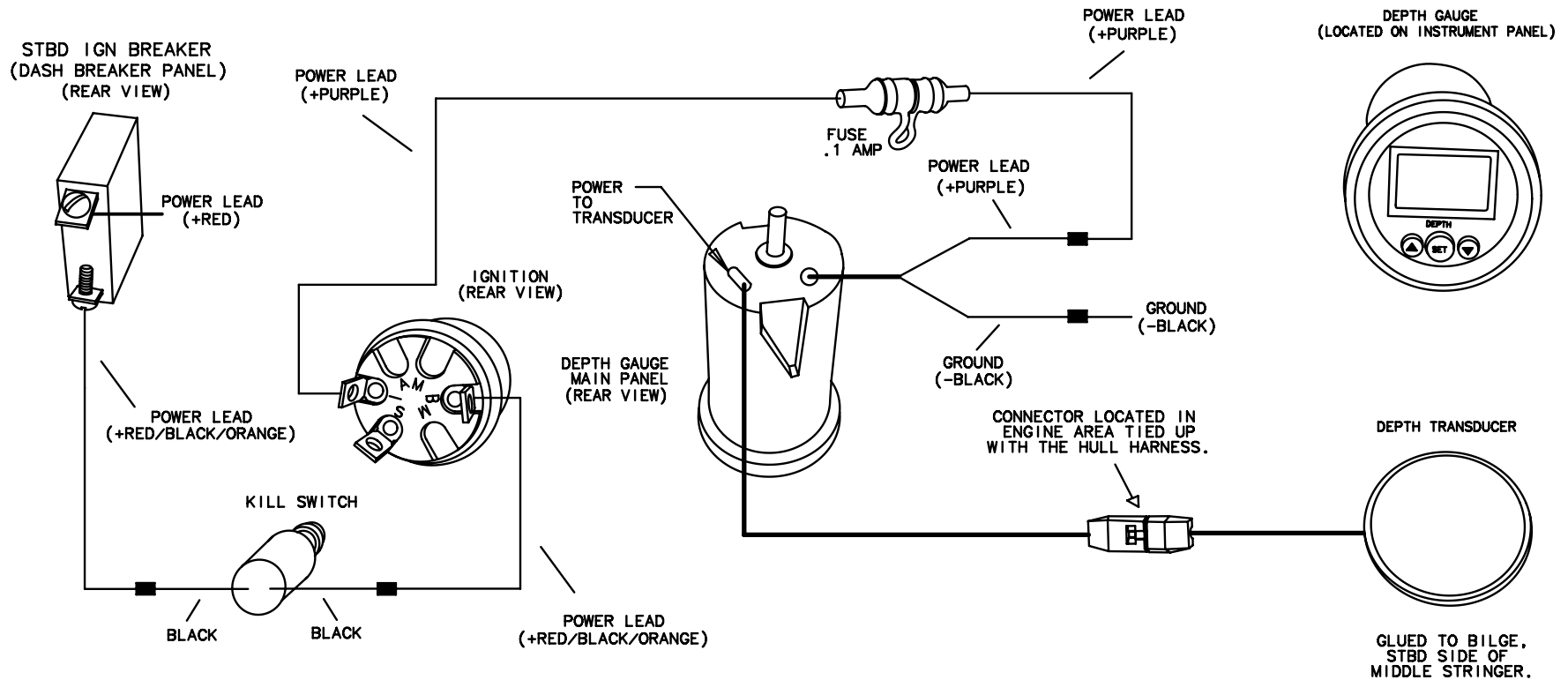

TITLE: DEPTH SOUNDER STANDARD		THUNDERBIRD PRODUCTS	
		P.O. BOX 1003	
MOD.: 330 CBR	DR BY: KPP	DECATUR IN., 46733	
NO.: 33	DATE: 7-1-15	(260) 724-9111	

POS	COLOR	STRIPE	STRIPE GA	DESCRIPTION
111	BLACK			1 4 ENGINE GROUND STBD (ENGINE TO DASH)
112	GREY			1 4 TACH STBD (ENGINE TO TACH)
113	TAN			1 4 WATER TEMP SNDR STBD (ENG TO GAUGE)
114	TAN	BLUE		1 4 AUDIBLE ALARM STBD (ENG SWS TO ALARM)
115	PURPLE			1 4 IGNITION SWITCHED + (IGN TO DASH/ENG)
116	RED			1 4 ENGINE MAIN 12V + STBD (ENG TO BKR)
117	RED	BLACK	ORANGE	1 4 ENG MAIN 12V + STBD (BKR TO KILL SW)
118	YELLOW	RED		1 4 IGN START STBD (NEU/SFTY SW TO START SOLE)
119	YELLOW	RED	RED	1 4 IGN START STBD (IGN SW TO NEU/SFTY SW)
120	LTBLUE			1 4 OIL PRESSURE STBD (ENG TO GAUGE)
121	PURPLE	WHITE		1 4 OUTDRIVE TRIM INDICATOR (SNDR TO GAUGE)
145	RED	BLACK	ORANGE	1 4 ENGINE MAIN 12V + STBD (KILL SW TO IGN)
146	BLUE			1 6 CAN 1 + (ENG TO SMARTCRAFT)
147	WHITE			1 6 CAN 1 - (ENG TO SMARTCRAFT)
489	WHITE	BLUE	PURPLE	1 4 MERCURY OBD-M LIGHT (ENGINE TO LIGHT +)
490	WHITE	BLUE	RED	1 4 MERCURY OBD-M LIGHT (ENGINE TO LIGHT -)

NOTE: SEE MerCRUISER MANUAL FOR FURTHER INFORMATION AND WIRING CONNECTIONS ON ENGINE EQUIPMENT.

NOTE: FOR SINGLE ENGINE BOATS, STBD WIRES AND HARDWARE ARE USED.

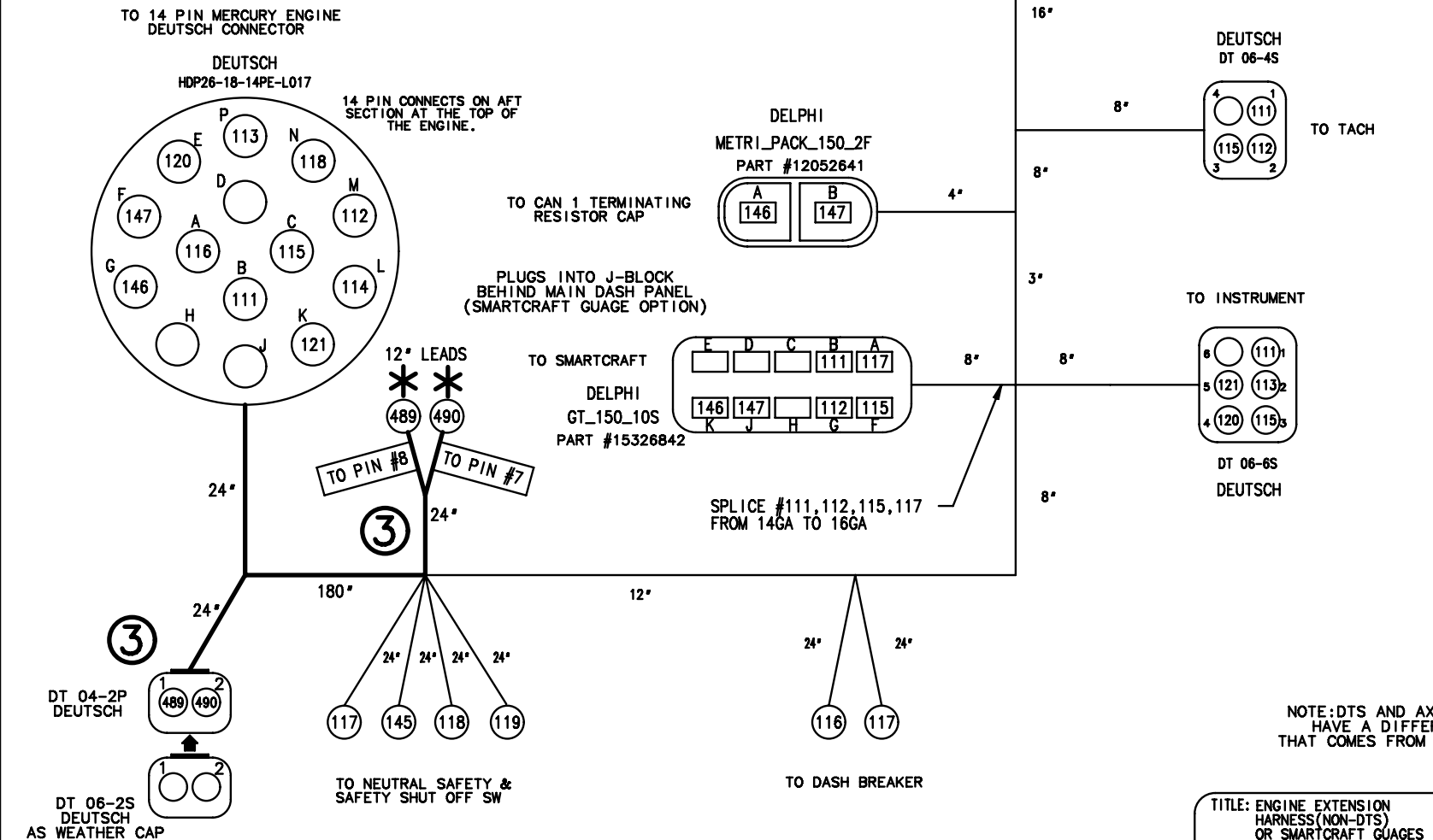

NOTE: DTS AND AXIUS BOATS WILL HAVE A DIFFERENT HARNESS THAT COMES FROM MERCURY MARINE.

TITLE: ENGINE EXTENSION HARNESS (NON-DTS) OR SMARTCRAFT GAUGES		THUNDERBIRD PRODUCTS
		P.O. BOX 1003
MOD.: 330 CBR	DR BY: KPP	DECATUR IN., 46733
NO.: 34	DATE: 7-1-15	(260) 724-9111

LEGEND

C-BREAKER PANEL

MOTOR

PLUG INTERCONNECT

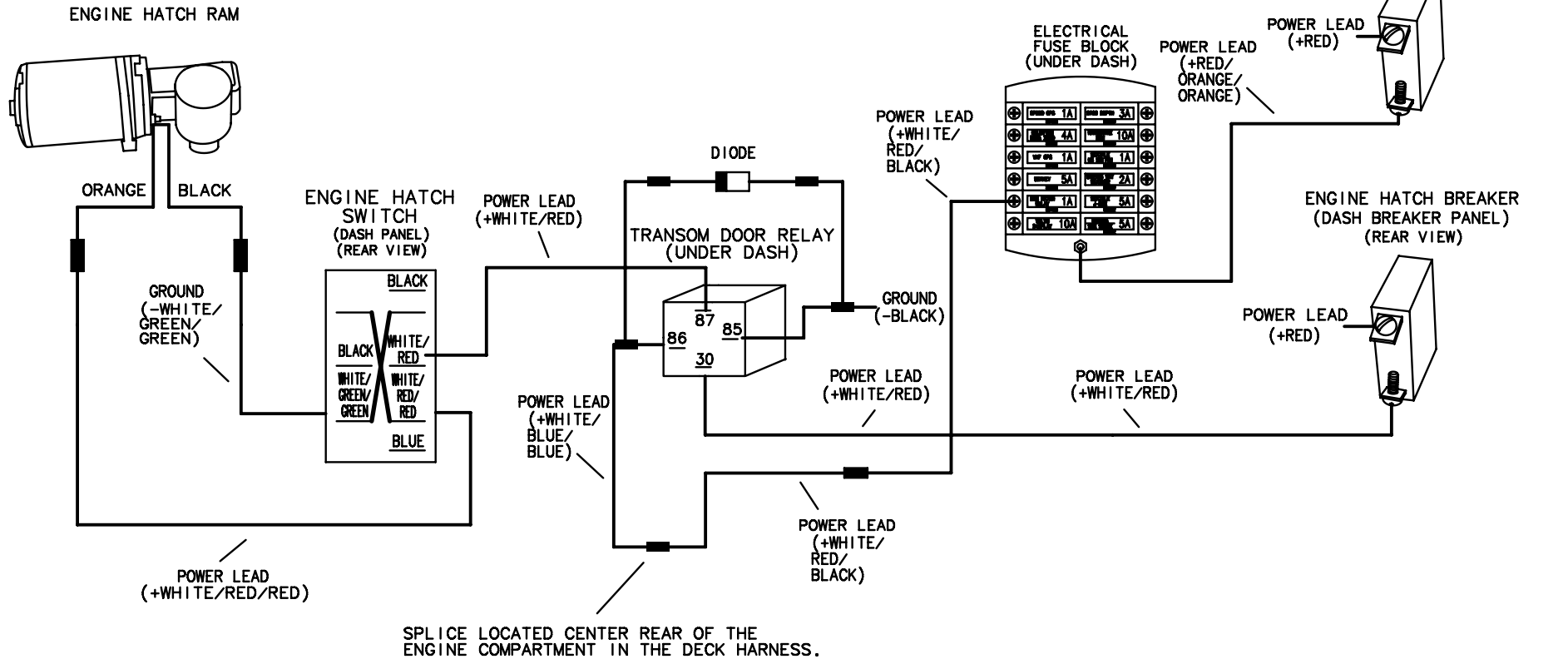
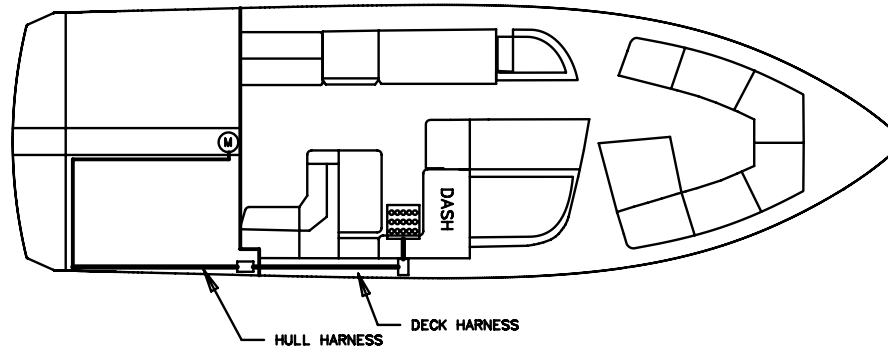

GROUND

CONNECTOR

TITLE: ENGINE HATCH RAM		THUNDERBIRD PRODUCTS	
		P.O. BOX 1003	
MOD.: 330 CBR	DR BY: KPP	DECATUR IN., 46733	
NO.: 35	DATE: 7-1-15	(260) 724-9111	

LEGEND

C-BREAKER PANEL

MOTOR

PLUG INTERCONNECT

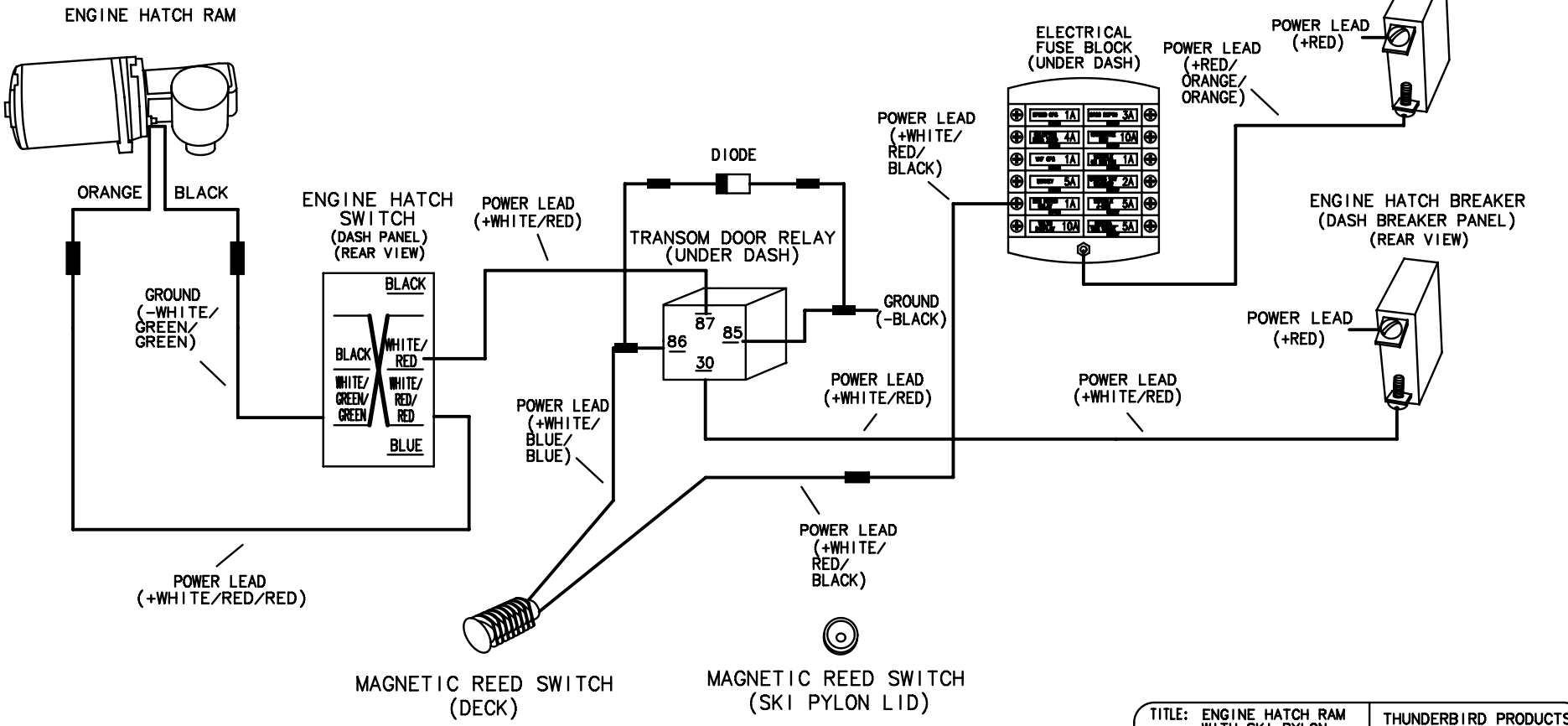
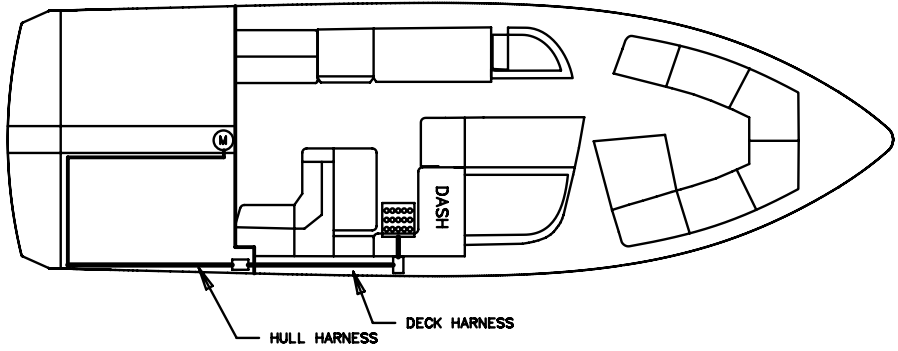

GROUND

CONNECTOR

TITLE: ENGINE HATCH RAM WITH SKI PYLON		THUNDERBIRD PRODUCTS
		P.O. BOX 1003
MOD.: 330 CBR	DR BY: KPP	DECATUR IN., 46733
NO.: 36	DATE: 7-1-15	(260) 724-9111

DIESEL FIRE SHUTDOWN SYSTEM

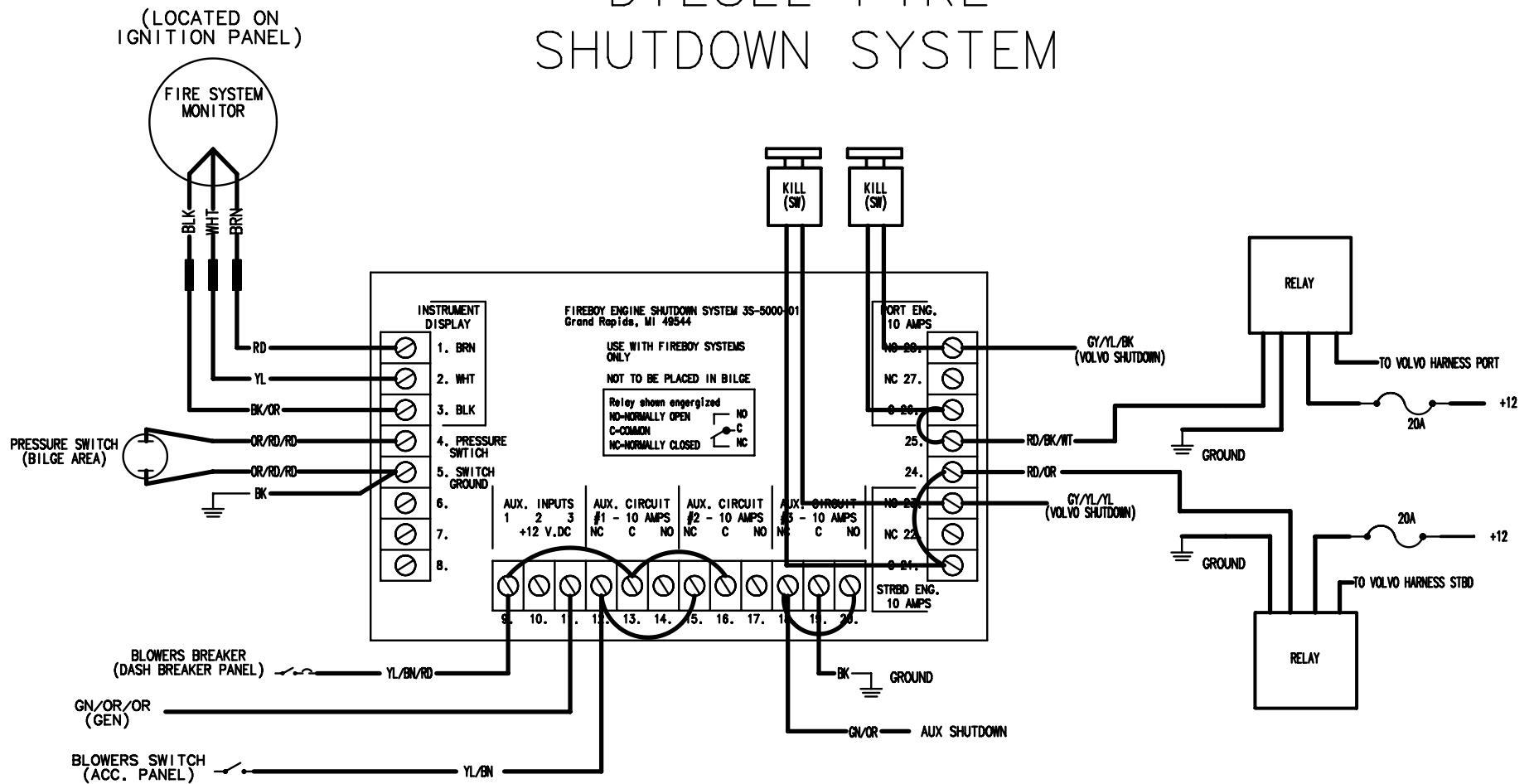

LOCATED BEHIND THE
MAIN DASH PANEL

LEGEND

C-BREAKER PANEL 

PLUG INTERCONNECT 

GROUND 

CONNECTOR 

TO TEST THE DISPLAY, PRESS AND HOLD THE TEST BUTTON. THE WARNING INDICATOR SHOULD LIGHT IMMEDIATELY, AND THE ALARM WILL SOUND AFTER 10 SECONDS. USE THE MUTE BUTTON TO SILENCE THE ALARM.

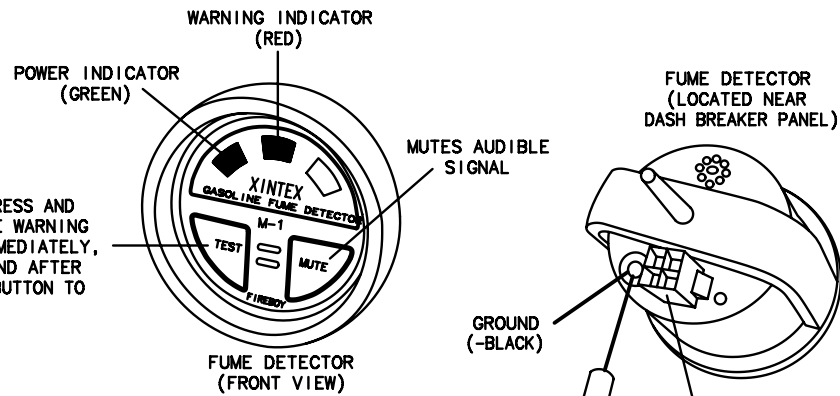

FUME DETECTOR (DASH BREAKER PANEL) (REAR VIEW)

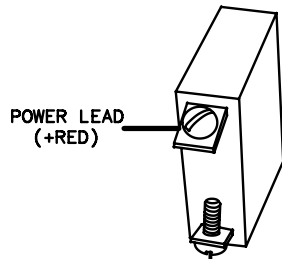

.5 AMPS FUSE

RED

POWER LEAD (+ORANGE/BROWN/RED)

FUME DETECTOR (LOCATED NEAR DASH BREAKER PANEL)

GROUND (-BLACK)

POWER CORD (GRAY)

NOTE: GREY POWER CORD RUNS WITH THE HARNESS UP TO THE DASH.

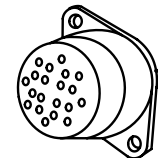
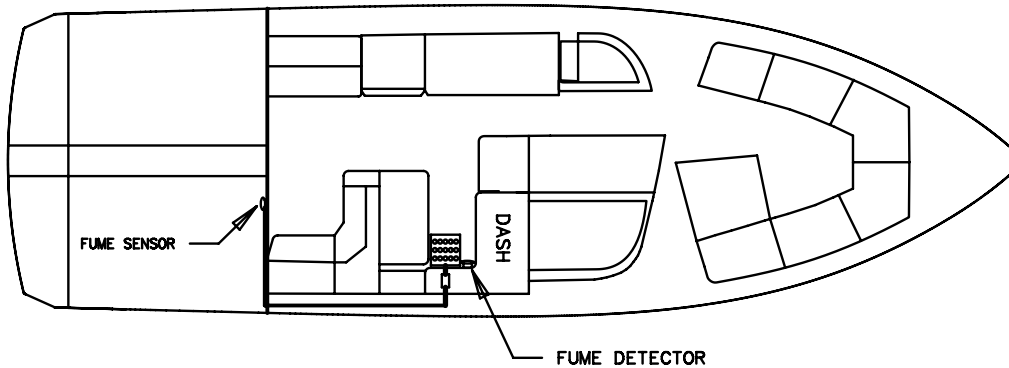

FUME SENSOR (ENGINE BILGE)

TITLE: FUME DETECTOR		THUNDERBIRD PRODUCTS	
		P.O. BOX 1003	
MOD.: 330 CBR	DR BY: KPP	DECATUR IN., 46733	
NO.: 38	DATE: 7-1-15	(260) 724-9111	

LEGEND

C-BREAKER
PANEL



PLUG
INTERCONNECT

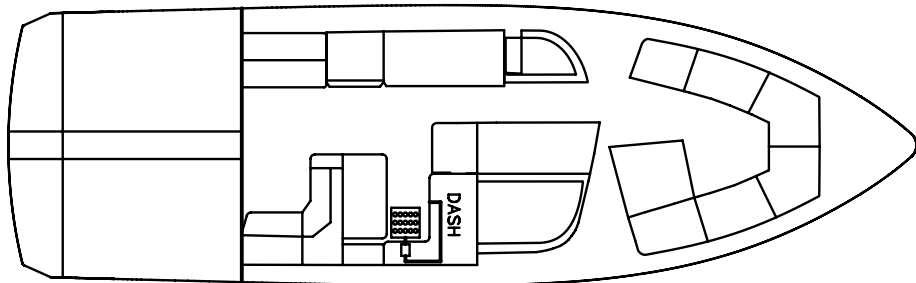
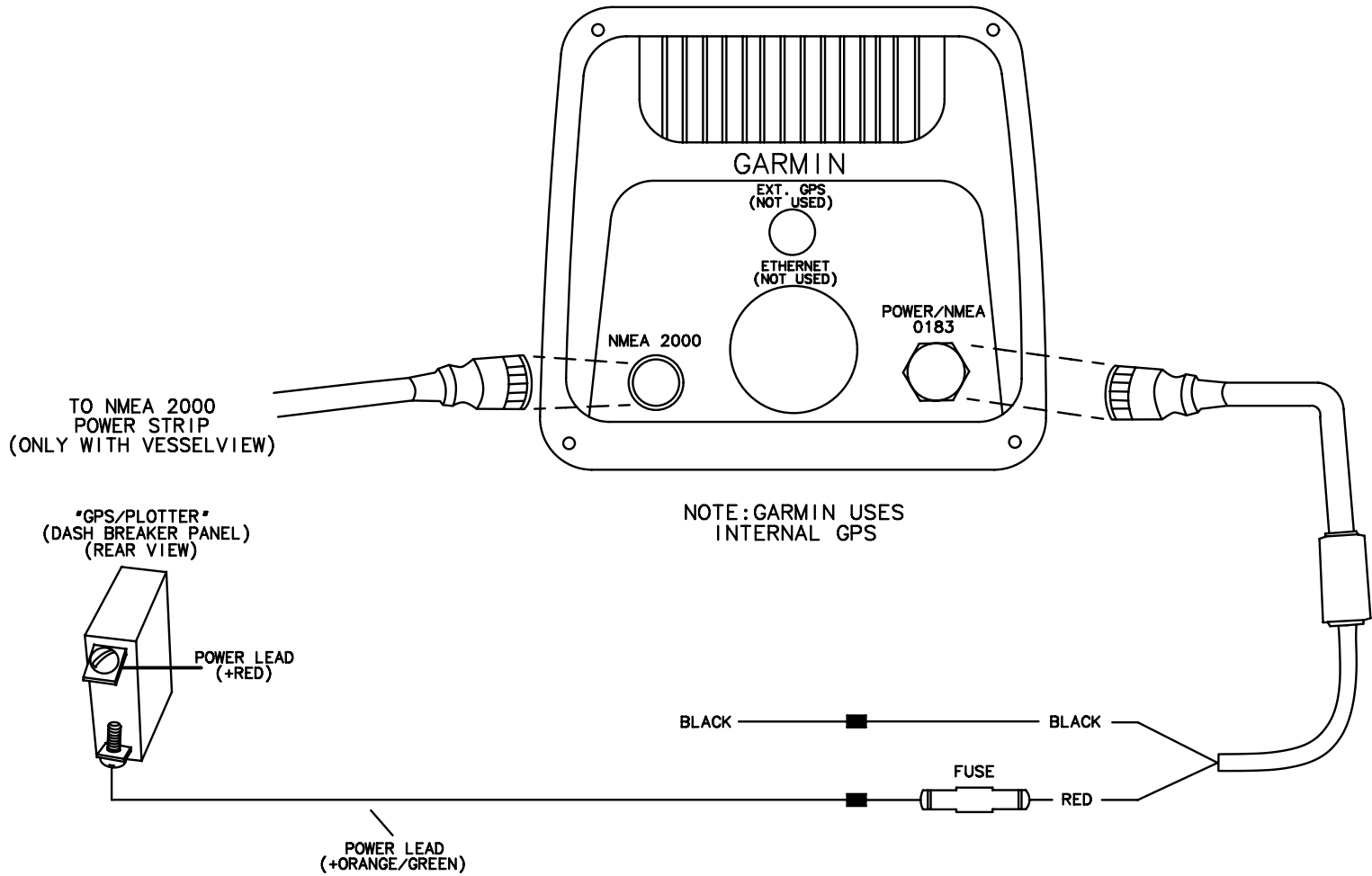

TITLE: GPS/GARMIN		THUNDERBIRD PRODUCTS
		P.O. BOX 1003
MOD.: 330 CBR	DR BY: KPP	DECATUR IN., 46733
NO.: 39	DATE: 7-1-15	(260) 724-9111

LEGEND

C-BREAKER PANEL

PLUG INTERCONNECT

GROUND

CONNECTOR

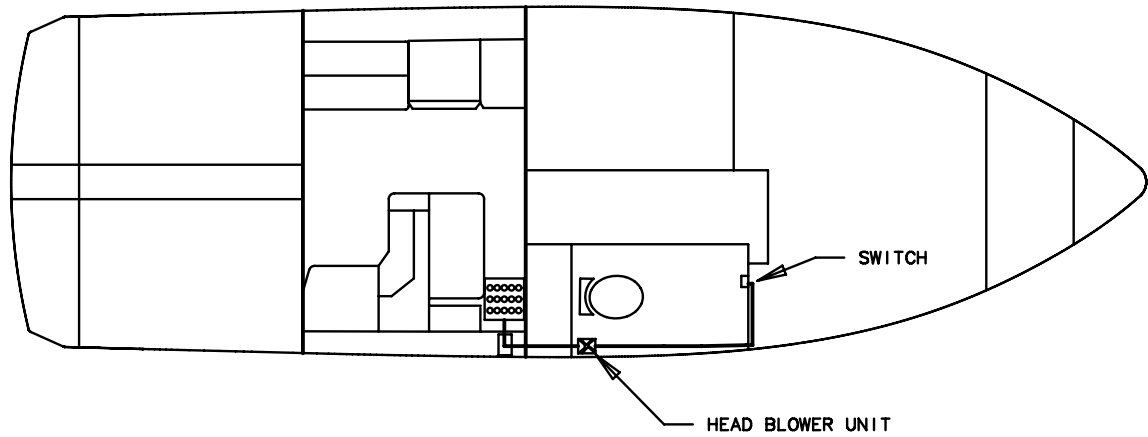
HEAD BLOWER BREAKER
 DASH BREAKER PANEL
 (REAR VIEW)

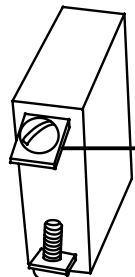

POWER LEAD
 (+RED)

POWER LEAD
 (+YELLOW/WHITE)
 10 GA.

BLOWER ACCENT LIGHT LIGHT
 (REAR VIEW)

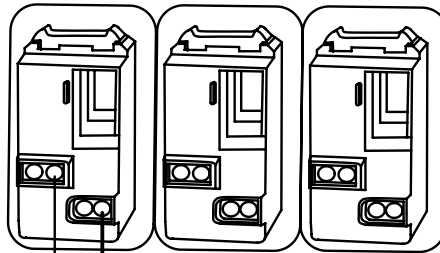

POWER LEAD
 (+YELLOW/WHITE)
 14 GA.

1/2 AMP
 FUSE

HEAD BLOWER UNIT

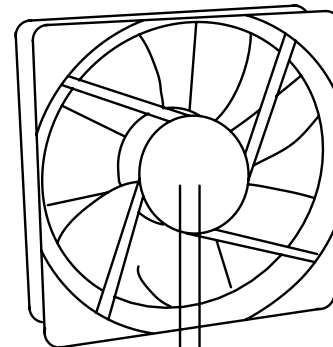

(+RED)

(-BLUE)

GROUND
 (-BLACK)

TITLE: HEAD UNIT BLOWER		THUNDERBIRD PRODUCTS
		P.O. BOX 1003
MOD.: 330 CBR	DR BY: KPP	DECATUR IN., 46733
NO.: 40	DATE: 7-1-15	(260) 724-9111

LEGEND

C-BREAKER PANEL 

GROUND 

PLUG INTERCONNECT 

SIREN 

CABIN HIGH WATER ALARM
LOCATED IN LAZARETTE

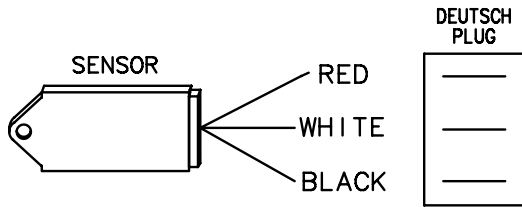

ORANGE/WHITE/RED (FROM BREAKER)
ORANGE/BLACK/RED (TO DASH ALARM)
BLACK (-GROUND)

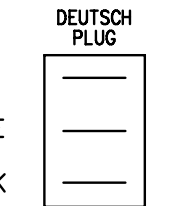

LOCATED IN
ENGINE BILGE

ORANGE/WHITE/RED (FROM BREAKER)
ORANGE/BLACK/RED (TO DASH ALARM)
BLACK (-GROUND)

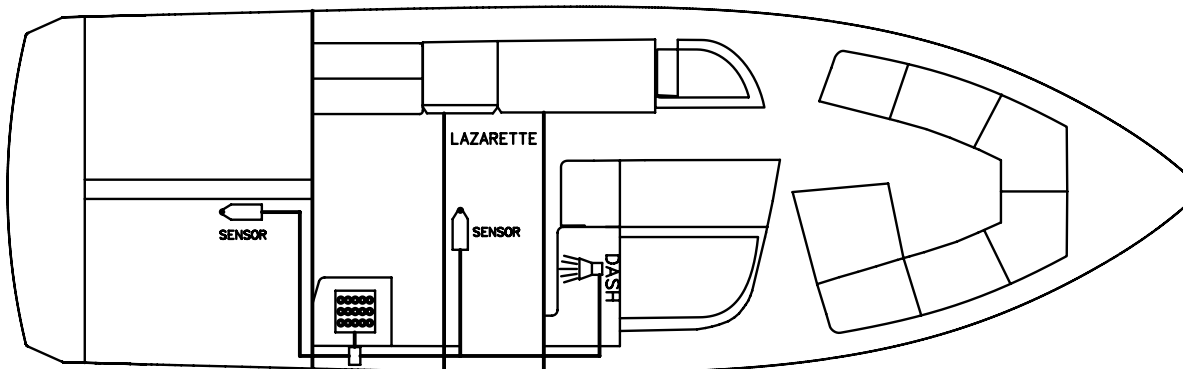

HIGH WATER ALARM BREAKER
AFT BREAKER PANEL
(REAR VIEW)

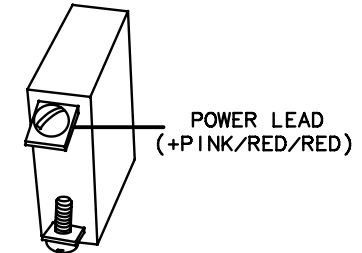

POWER LEAD
(+ORANGE/BLACK/RED)

POWER LEAD
(+ORANGE/WHITE/RED)

HIGH WATER ALARM SIREN
(LOCATED UNDER DASH)

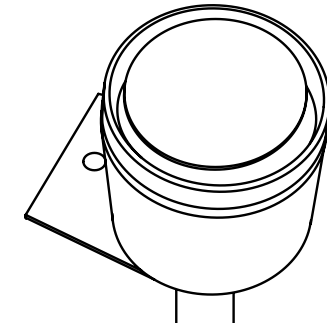

POWER LEAD (+ORANGE/BLACK/RED) GROUND (-BLACK)

TITLE: HIGH WATER ALARM		THUNDERBIRD PRODUCTS	
		P.O. BOX 1003	
MOD.: 330 CBR	DR BY: KPP	DECATUR IN., 46733	
NO.: 41	DATE: 7-1-15	(260) 724-9111	

LEGEND

C-BREAKER PANEL 

PLUG INTERCONNECT 

GROUND 

AIR HOSE 

HORN COMPRESSOR MAINTENANCE

LUBRICATION (Very Important)

Lubricate compressor every 4-5 months. Remove air hose from compressor and apply 3 to 4 drops of light machine oil into the air port. Let oil set for a few minutes and then activate the compressor momentarily to distribute the oil. Reconnect the air hose.

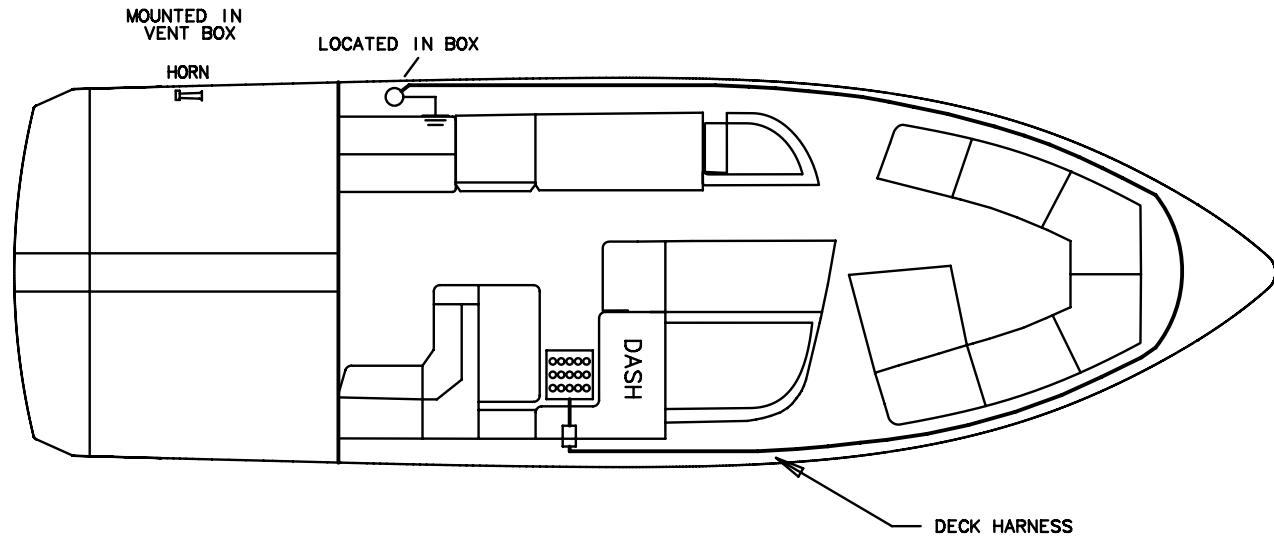

HORN BREAKER
(DASH BREAKER PANEL)
(REAR VIEW)

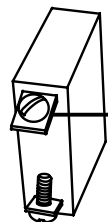

POWER LEAD
(+RED)

POWER LEAD
(+ORANGE/WHITE)

HORN SWITCH
(IGN. PANEL)
(REAR VIEW)

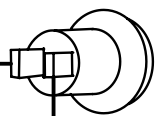

POWER LEAD
(+ORANGE/WHITE/WHITE)

BLACK
(-GROUND)

HORN
COMPRESSOR

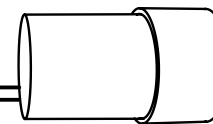

FIBERGLASS ARCH OPTION:
HORN IS MOUNTED ON TOP
OF ARCH WITH AIR HOSE
RUNNING UP THE PORT ARCH
LEG. COMPRESSOR LOCATION
IS THE SAME.

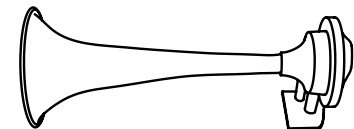

AIR HOSE

ONE WAY
AIR VALVE
(WITHIN 6"
OF COMPRESSOR)

TITLE: HORN		THUNDERBIRD PRODUCTS	
		P.O. BOX 1003	
MOD.: 330 CBR	DR BY: KPP	DECATUR IN., 46733	
NO.: 42	DATE: 7-1-15	(260) 724-9111	

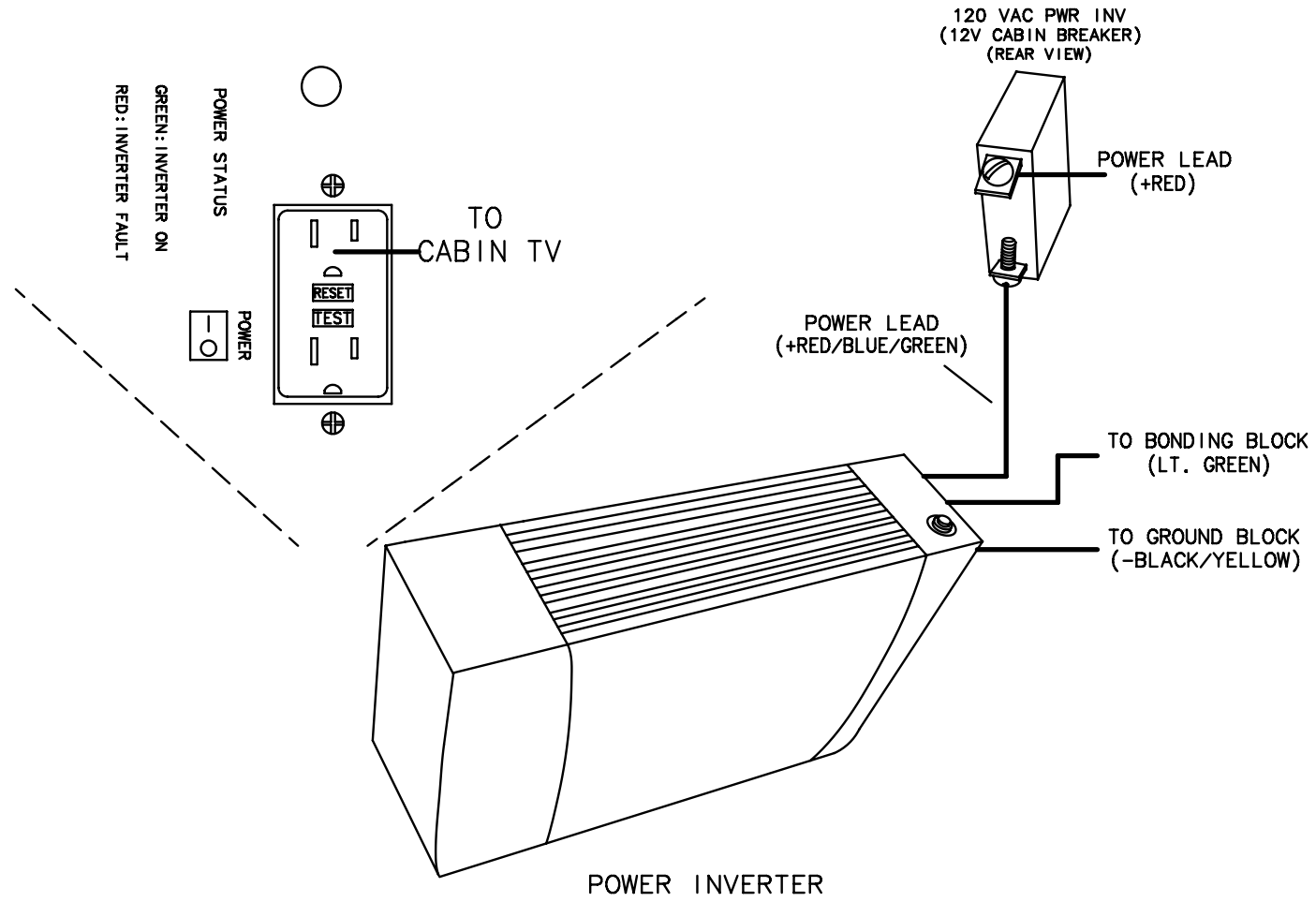

LOCATED IN LAZARETTE
ON STARBOARD SIDE

TITLE: INVERTER		THUNDERBIRD PRODUCTS
		P.O. BOX 1003
MOD.: 330 CBR	DR BY: KPP	DECATUR IN., 46733
NO.: 43	DATE: 7-1-15	(260) 724-9111

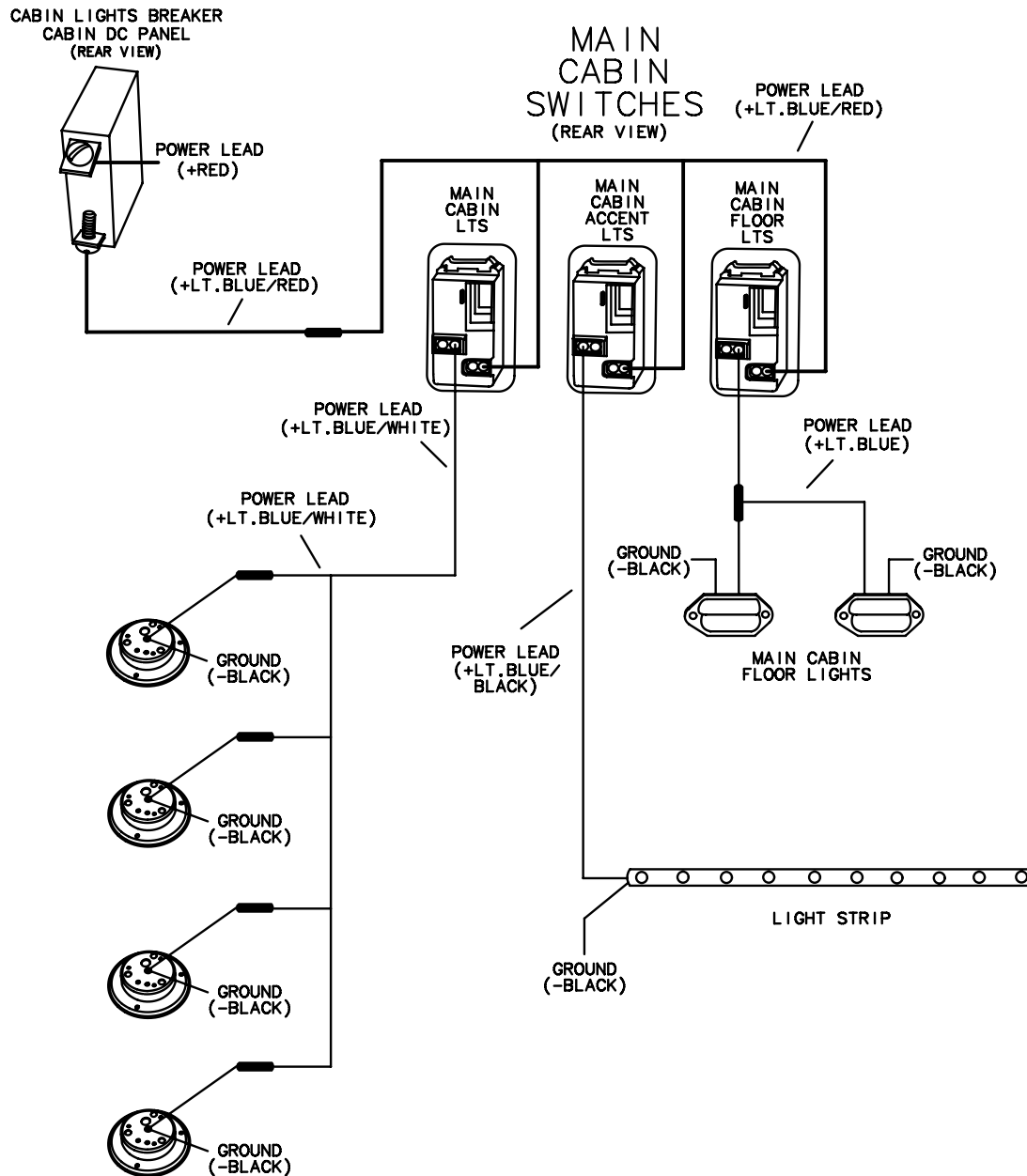

TITLE: CABIN LIGHTS		THUNDERBIRD PRODUCTS
		P.O. BOX 1003
MOD.: 330 CBR	DR BY: KPP	DECATUR IN., 46733
NO.: 44	DATE: 7-1-15	(260) 724-9111

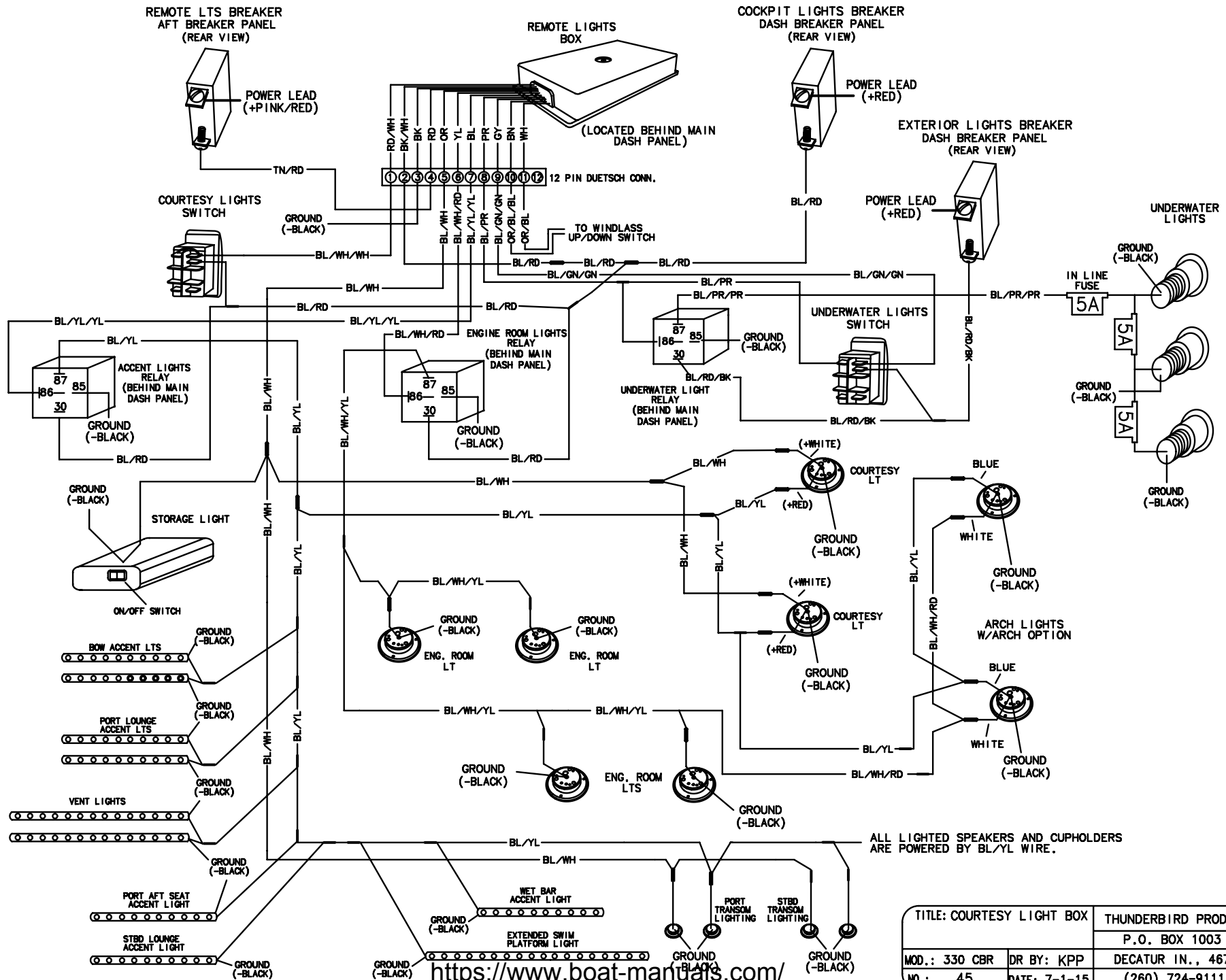

TITLE: COURTESY LIGHT BOX		THUNDERBIRD PRODUCTS	
		P.O. BOX 1003	
MOD.: 330 CBR	DR BY: KPP	DECATUR IN., 46733	
NO.: 45	DATE: 7-1-15	(260) 724-9111	

LEGEND

C-BREAKER PANEL



DOCKING LIGHT



PLUG



GROUND



CONNECTOR



EXTERIOR LIGHTS BREAKER
(DASH BREAKER PANEL)
(REAR VIEW)

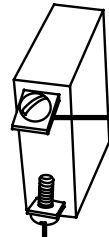

POWER LEAD
(+RED)

POWER LEAD
(+BLUE/RED/BLACK)

DOCKING LIGHTS SWITCH
(DASH PANEL)
(REAR VIEW)

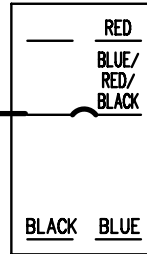

DOCKING LIGHTS
(REAR VIEW)

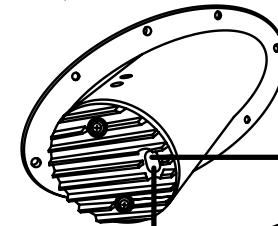

GROUND
(-BLACK)

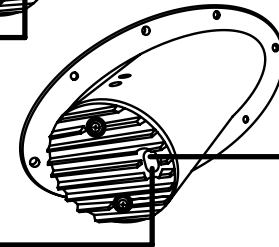

GROUND
(-BLACK)

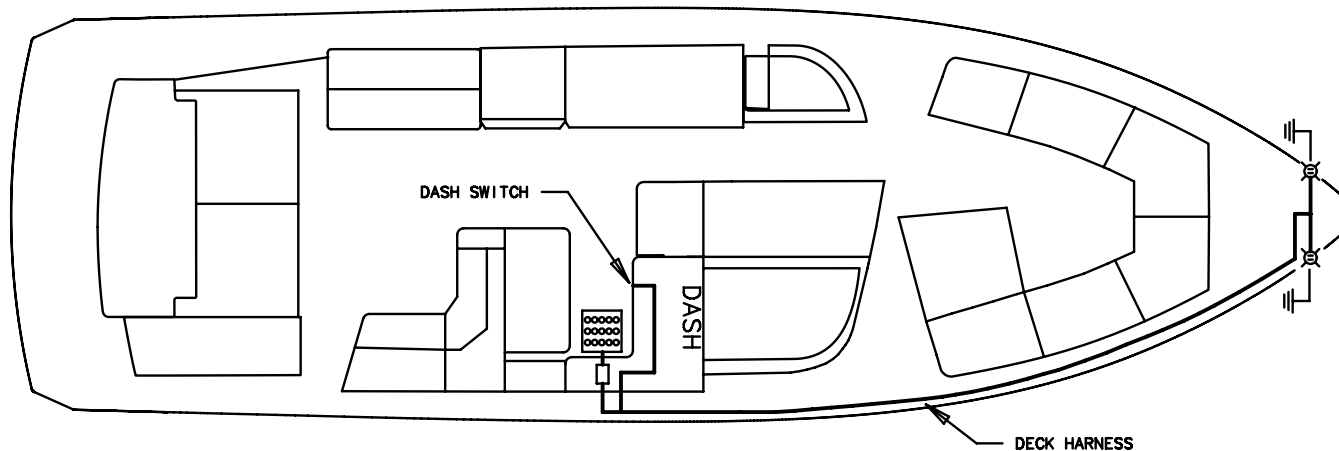

TO OPERATE:

1. THE AUXILIARY BATTERY SWITCH UNDER THE WETBAR MUST BE TURNED ON.
2. THE 'EXTERIOR LIGHTS' BUTTON ON THE UNDER DASH BREAKER PANEL, MUST BE PUSHED IN OR CONNECTED.
3. THE PANEL IS NOW SUPPLIED WITH 12V DC POWER.
4. TURN ON 'DOCKING LIGHTS' SWITCH ON DASH.

<https://www.boat-manuals.com/>

TITLE: DOCKING LIGHTS		THUNDERBIRD PRODUCTS
		P.O. BOX 1003
MOD.: 330 CBR	DR BY: KPP	DECATUR IN., 46733
NO.: 46	DATE: 7-1-15	(260) 724-9111

LEGEND

BREAKER PANEL	
LIGHT	
PLUG INTERCONNECT	
GROUND	
CONNECTOR	

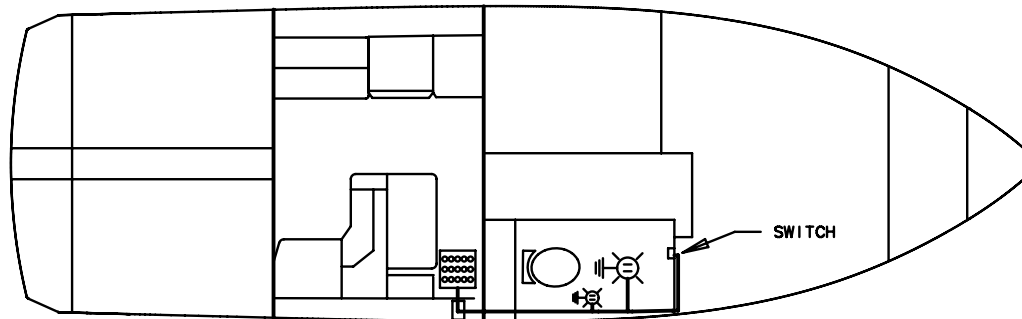
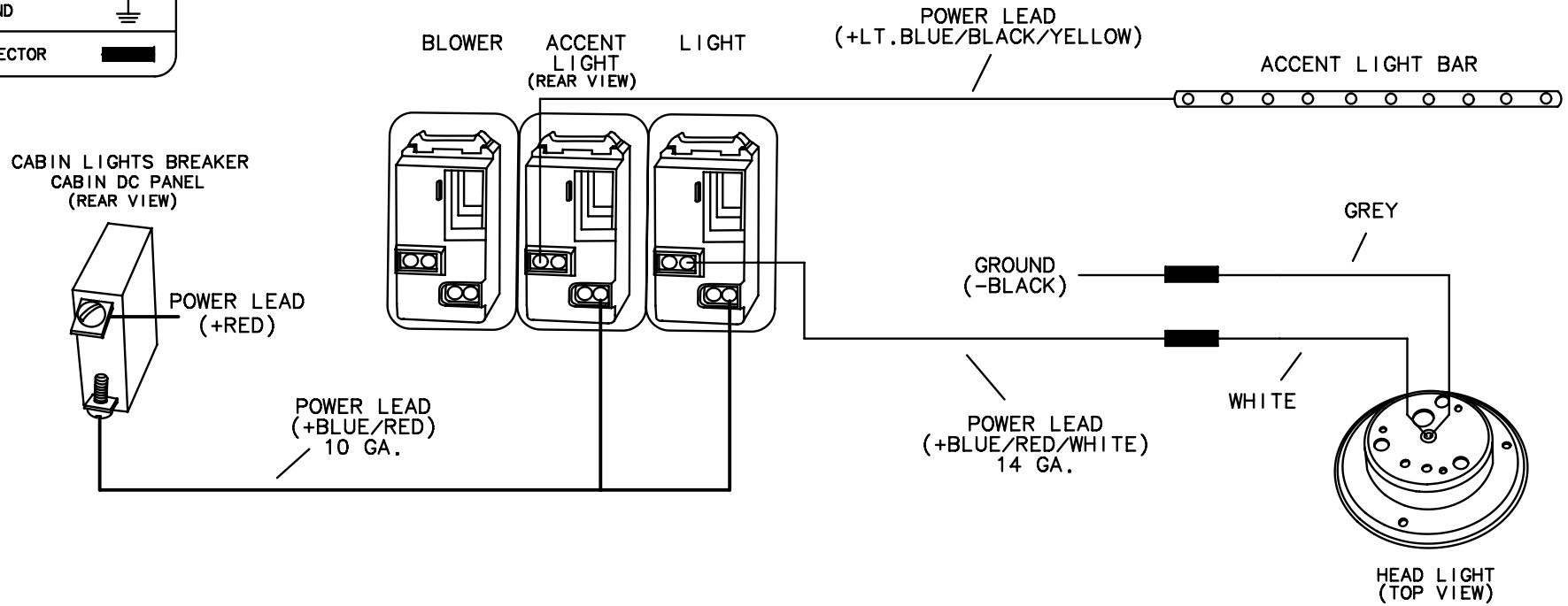

TITLE: HEAD UNIT LIGHTS		THUNDERBIRD PRODUCTS
		P.O. BOX 1003
MOD.: 330 CBR	DR BY: KPP	DECATUR IN., 46733
NO.: 47	DATE: 7-1-15	(260) 724-9111

LEGEND

C-BREAKER PANEL 

LIGHT 

PLUG INTERCONNECT 

GROUND 

CONNECTOR 

EXTERIOR LIGHTS BREAKER
DASH BREAKER PANEL
(REAR VIEW)

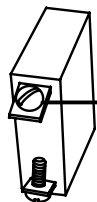

POWER LEAD
(+RED)

NAV/ANCH LIGHTS SWITCH
(DASH PANEL)
(REAR VIEW)

NAV/ANCH
LTS

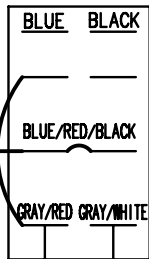

POWER LEAD
(+BLUE/RED/BLACK)

MAST/ANCHOR
LIGHT

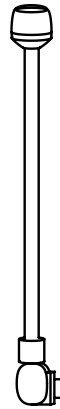

GROUND
(-BLACK)

POWER LEAD
(+GRAY/RED)

GROUND
(-BLACK)



PORT NAVIGATION LIGHT
(REAR VIEW)
(RED LIGHT)
(ON ARCH)

GROUND
(-BLACK)



STBD NAVIGATION LIGHT
(REAR VIEW)
(GREEN LIGHT)
(ON ARCH)

POWER LEAD
(+GRAY/WHITE)

IF NO ARCH, MAST/ANCHOR LIGHT
LOCATED ON PORT SIDE.

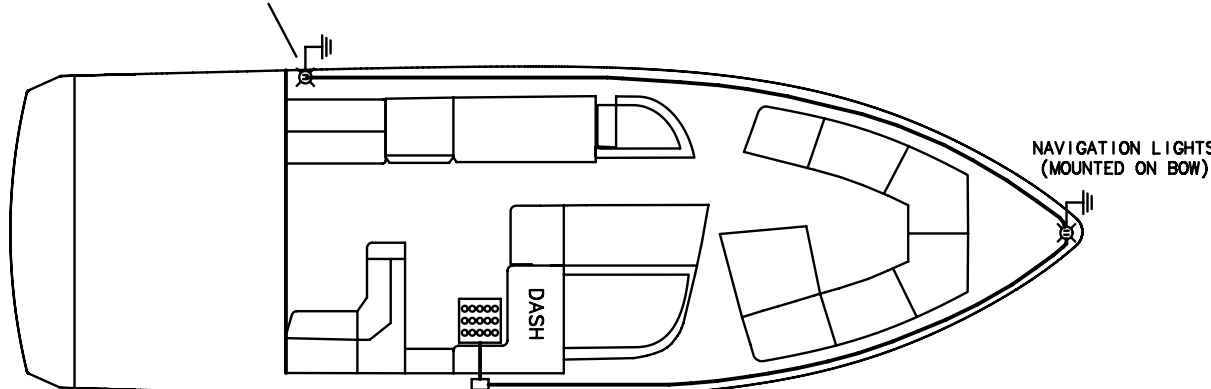

TO OPERATE:

1. THE AUXILIARY POWER UNDER THE WETBAR MUST BE TURNED ON.
2. THE "EXTERIOR LIGHTS" BUTTON ON THE UNDER DASH BREAKER PANEL, MUST BE PUSHED IN OR CONNECTED.
3. PANEL IS NOW SUPPLIED WITH 12V DC POWER. TURN ON NAV/ANCH LIGHTS SWITCH ON DASH.

TITLE: NAV/ANCH LIGHTS		THUNDERBIRD PRODUCTS
		P.O. BOX 1003
MOD.: 330 CBR	DR BY: KPP	DECATUR IN., 46733
NO.: 48	DATE: 7-1-15	(260) 724-9111

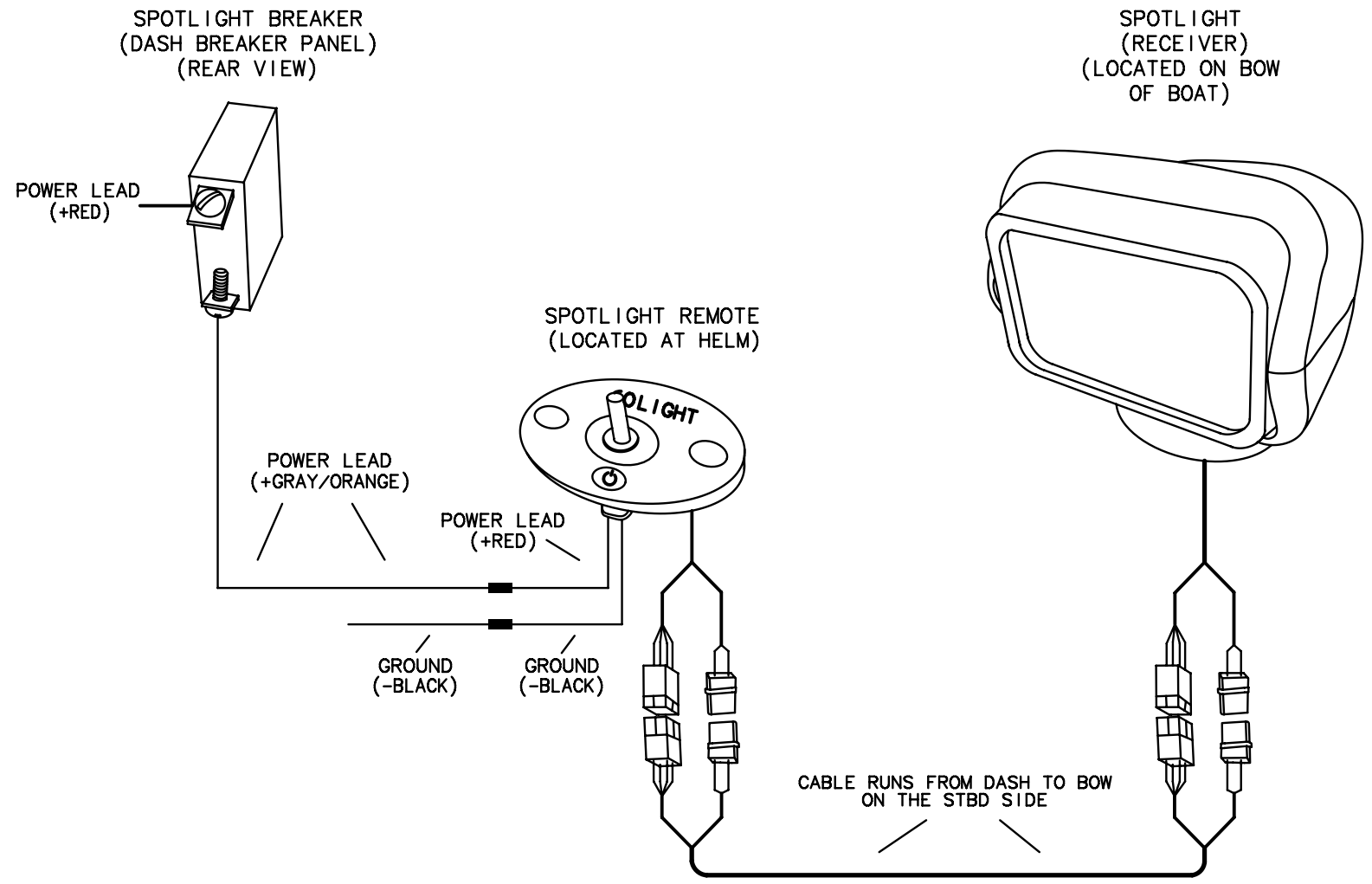

TITLE: SPOTLIGHT		THUNDERBIRD PRODUCTS
		P.O. BOX 1003
MOD.: 330 CBR	DR BY: KPP	DECATUR IN., 46733
NO.: 49	DATE: 7-1-15	(260) 724-9111

LEGEND

MACERATOR CONTROL	
GROUND	
PLUG INTERCONNECT	
CABIN DC PANEL	

WASTE SYSTEM BREAKER
CABIN DC PANEL
(REAR VIEW)

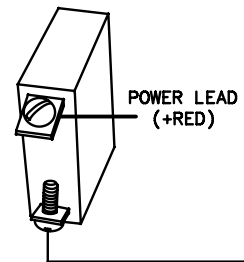

MACERATOR CONTROL

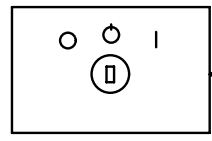

DEUTSCH CONNECTOR

- GREEN — BLACK/WHITE/YELLOW (TO "EMPTY" FLOAT)
- BROWN — GREEN/ORANGE (TO MACERATOR)
- RED — GREEN/RED (POWER IN)
- BLACK — BLACK (GROUND)

POWER LEAD
(+GREEN/RED)

GROUND
(-BLACK)

TANK FLOATS

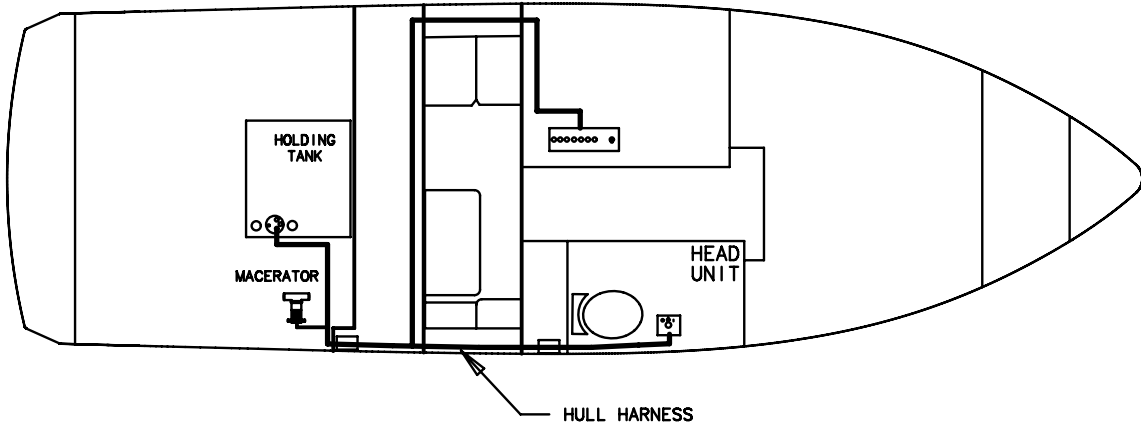
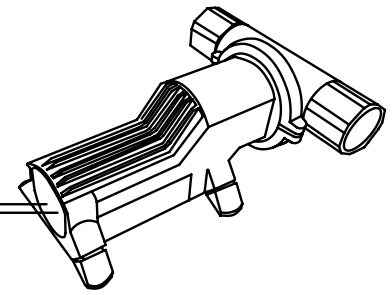
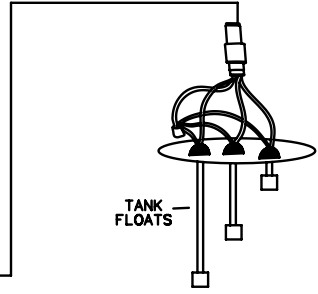

TITLE: MACERATOR (ELECTRICAL)		THUNDERBIRD PRODUCTS
		P.O. BOX 1003
MOD.: 330 CBR	DR BY: KPP	DECATUR IN., 46733
NO.: 50	DATE: 7-1-15	(260) 724-9111

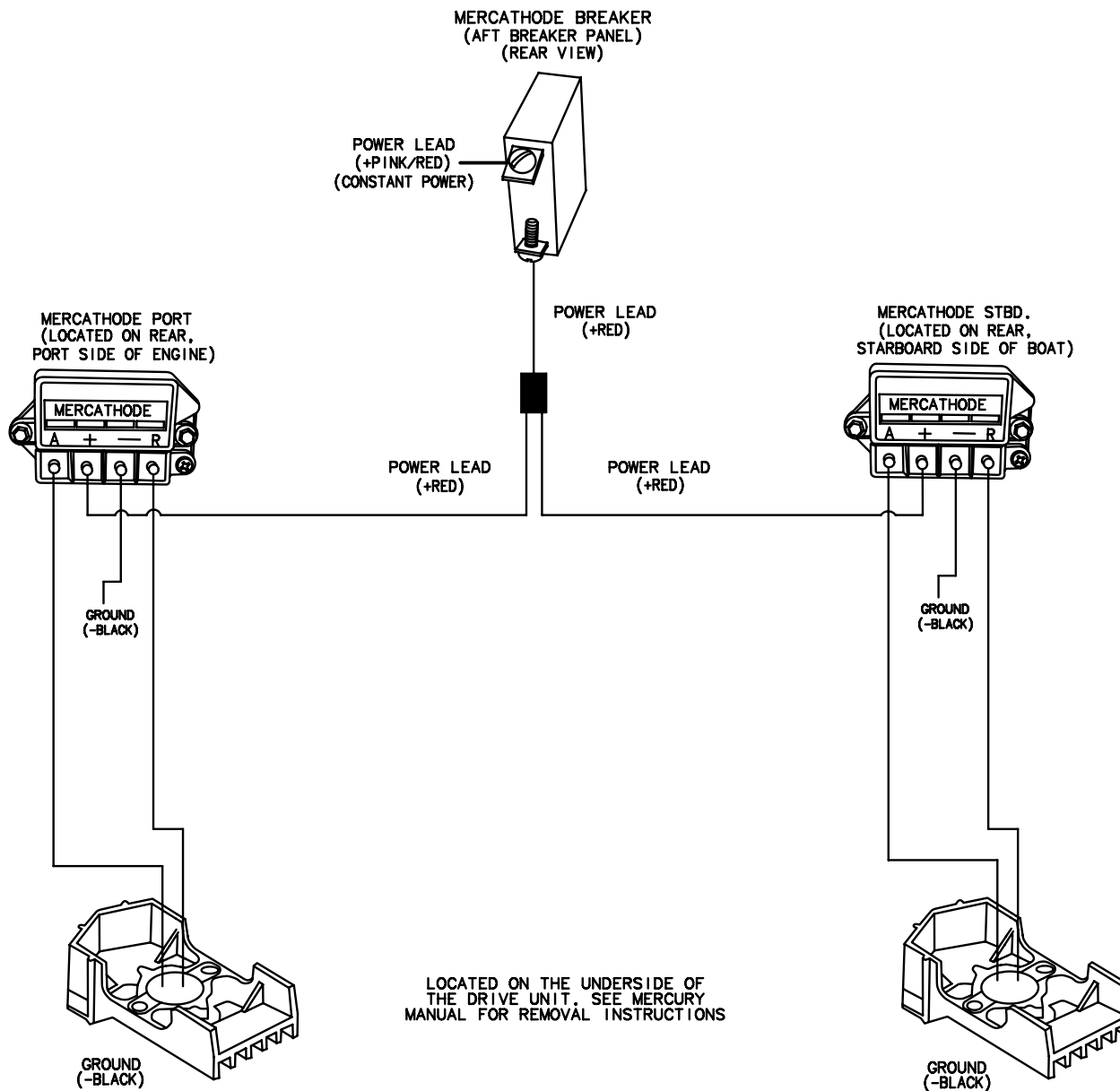

TITLE: MERCATHODE		THUNDERBIRD PRODUCTS
		P.O. BOX 1003
MOD.: 330 CBR	DR BY: KPP	DECATUR IN., 46733
NO.: 51	DATE: 7-1-15	(260) 724-9111

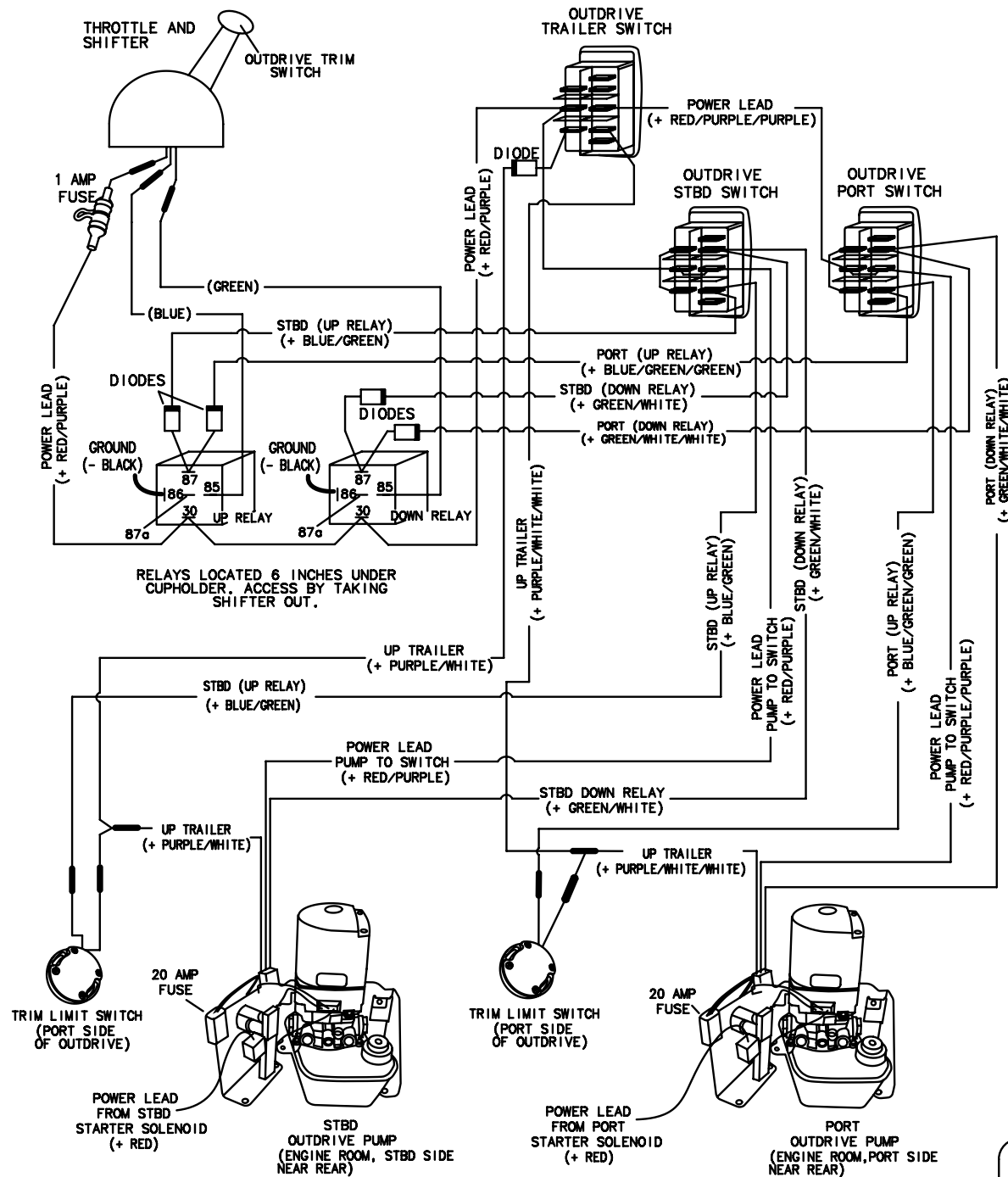

NOTE: REFER TO YOUR MERCURY OWNERS MANUAL FOR AXIUS/DTS OUTDRIVE PUMP WIRING.

TITLE: OUTDRIVE PUMP		THUNDERBIRD PRODUCTS	
		P.O. BOX 1003	
MOD.: 330 CBR	DR BY: KPP	DECATUR IN., 46733	
NO.: 52	DATE: 7-1-15	(260) 724-9111	

LEGEND

C-BREAKER
PANEL



GROUND



PLUG
INTERCONNECT

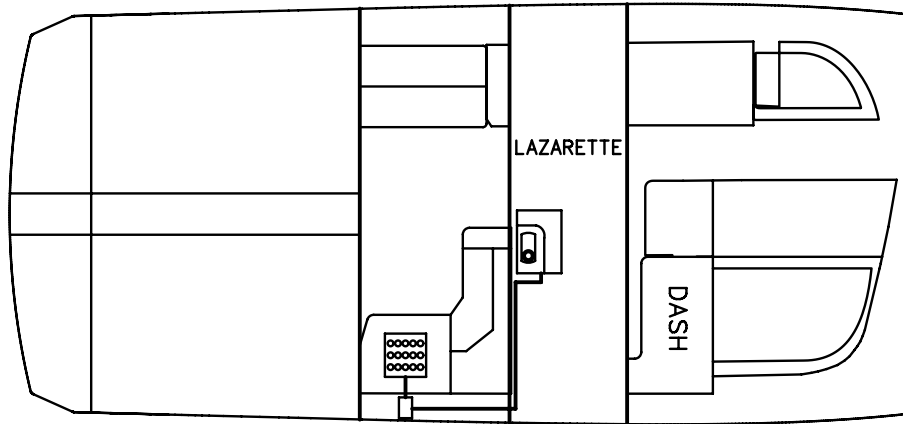

SHOWER SUMP BREAKERS
(AFT BREAKER PANEL)
(REAR VIEW)

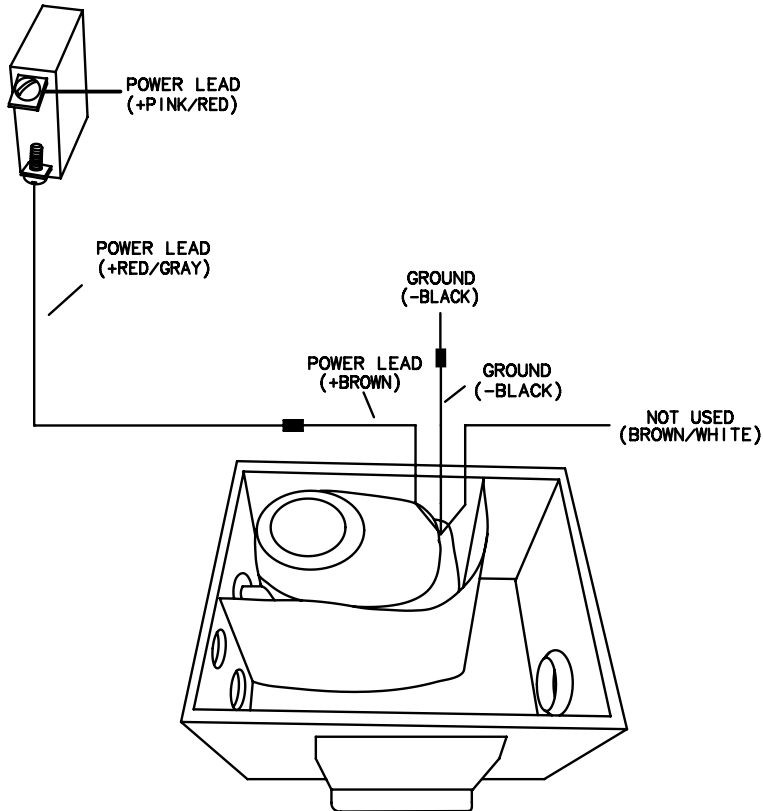

TITLE: SHOWER SUMP, ELECTRICAL		THUNDERBIRD PRODUCTS
		P.O. BOX 1003
MOD.: 330 CBR	DR BY: KPP	DECATUR IN., 46733
NO.: 53	DATE: 7-1-15	(260) 724-9111

STARTER SWITCH (PORT)

STARTER SWITCH (STBD)

SWITCHES LOCATED ON BATTERY SWITCH PANEL

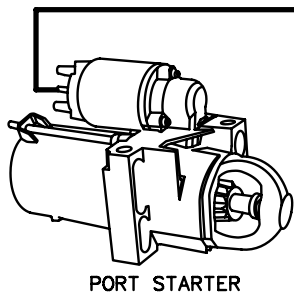
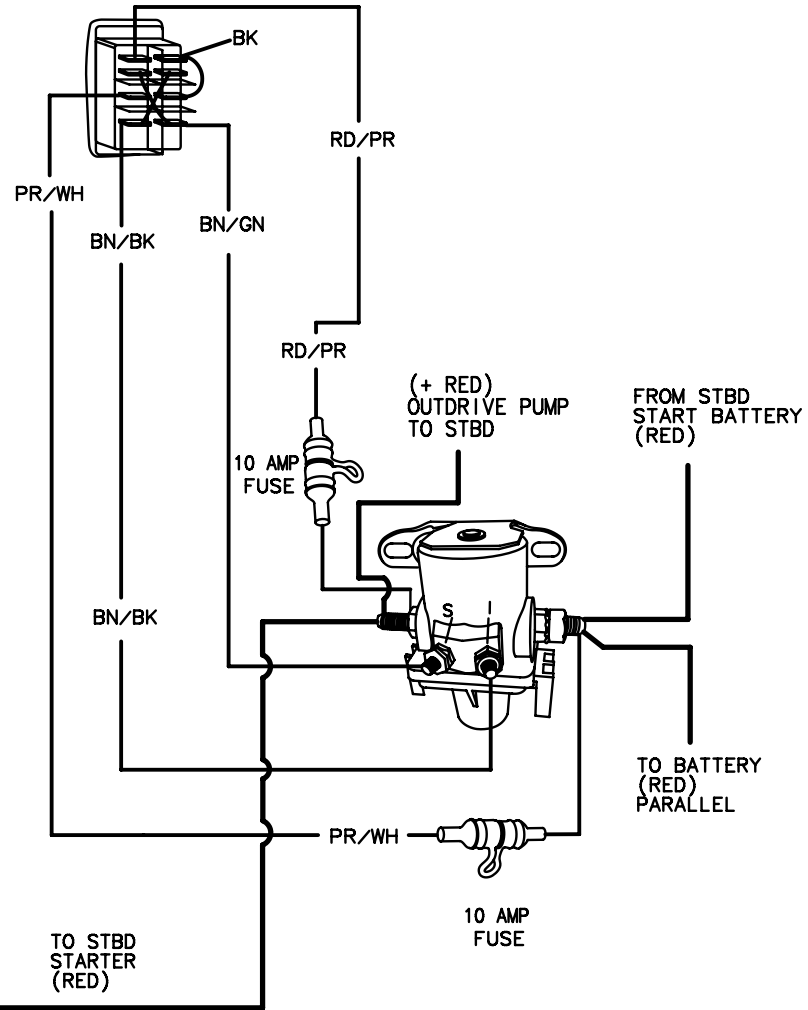
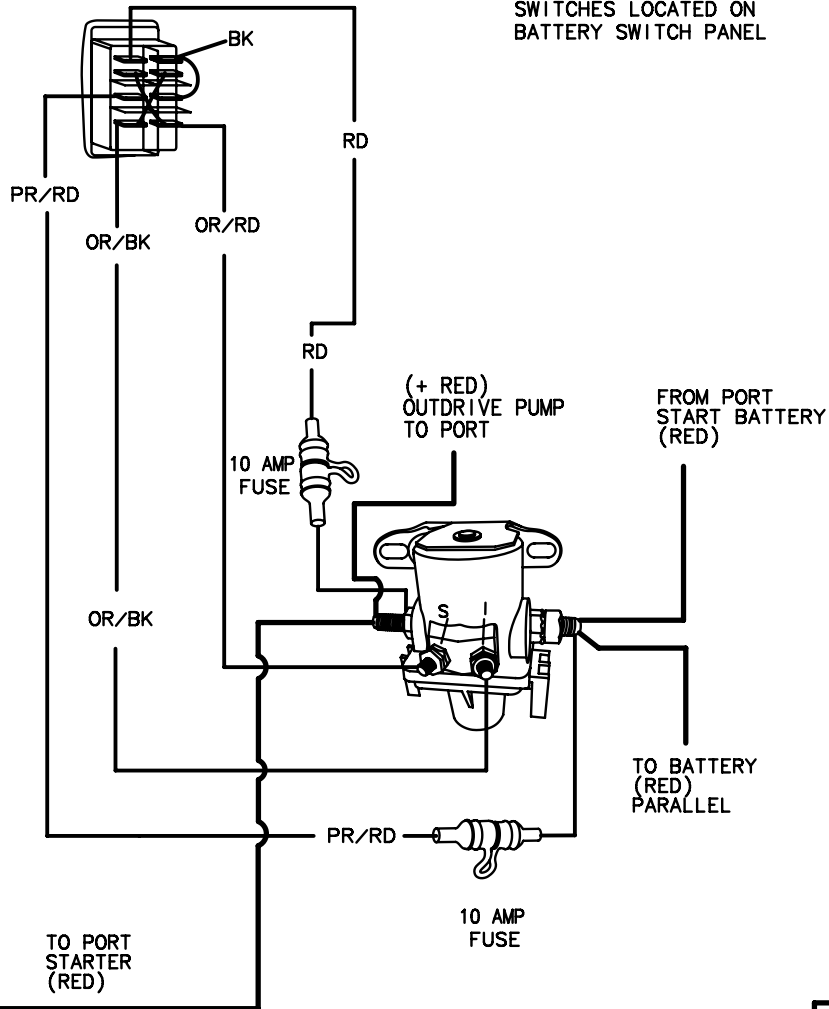

PORT STARTER

PORT STARTER SOLENOID
(LOCATED IN ENG. ROOM NEAR PORT OUTDRIVE PUMP)

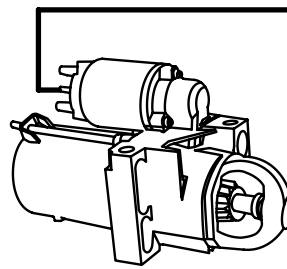

STBD STARTER

STBD STARTER SOLENOID
(LOCATED IN ENG. ROOM NEAR STBD OUTDRIVE PUMP)

TITLE: START SOLENOID		THUNDERBIRD PRODUCTS
		P.O. BOX 1003
MOD.: 330 CBR	DR BY: KPP	DECATUR IN., 46733
NO.: 54	DATE: 7-1-15	(260) 724-9111

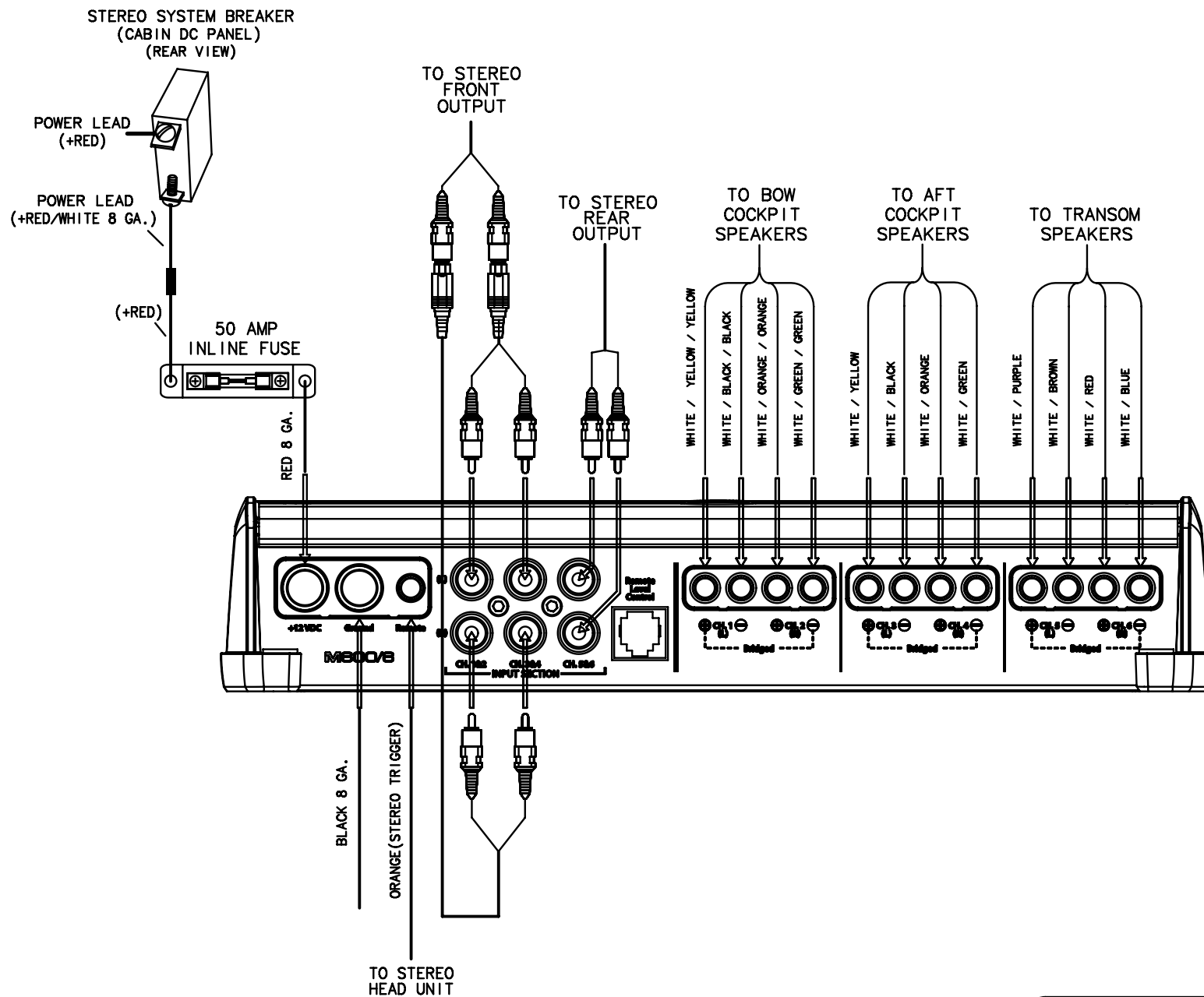

TITLE: STEREO AMP STANDARD		THUNDERBIRD PRODUCTS
		P.O. BOX 1003
MOD.: 330 CBR	DR BY: KPP	DECATUR IN., 46733
NO.: 55	DATE: 7-1-15	(260) 724-9111

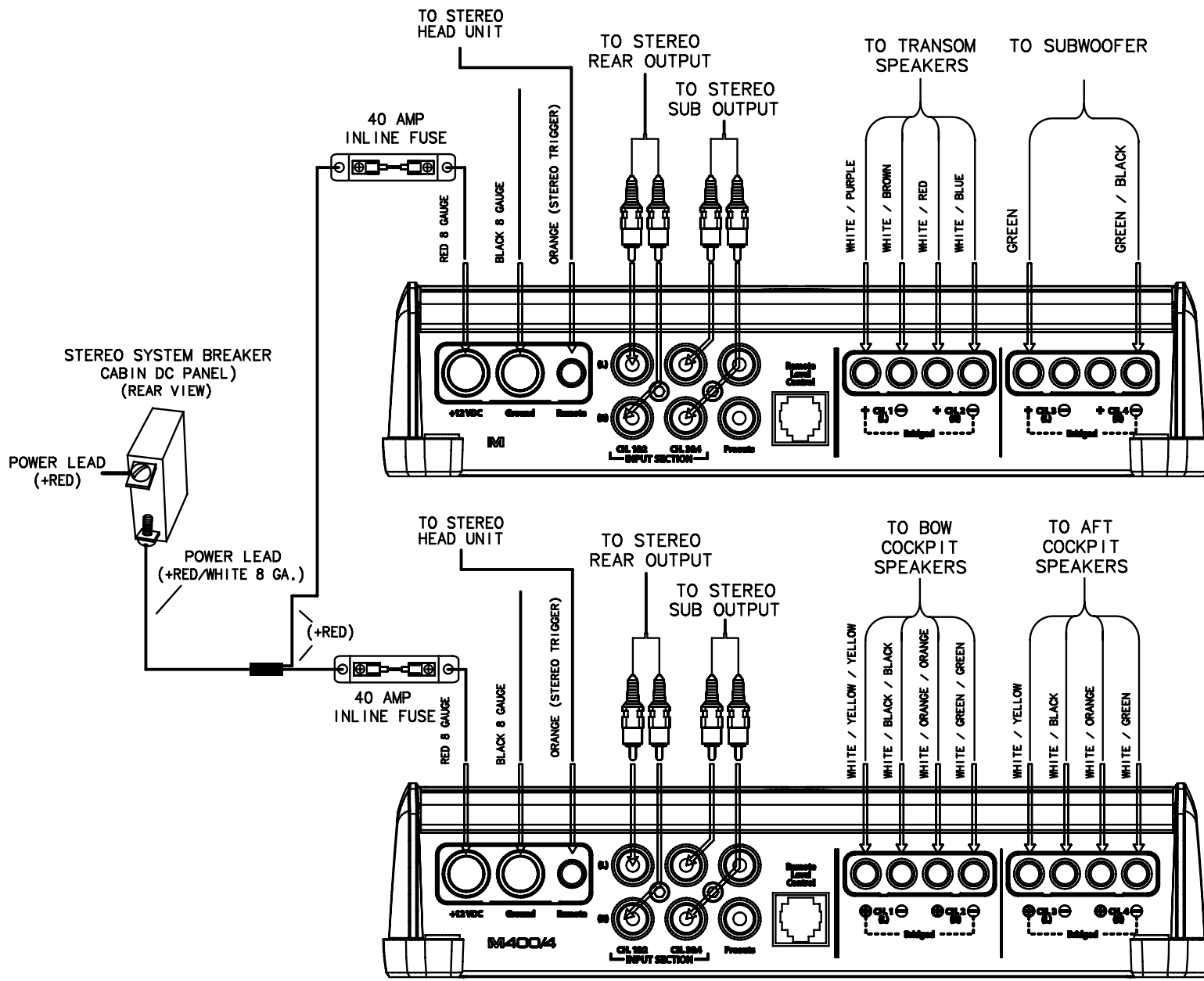

TITLE: STEREO AMP W/COCKPIT SUB		THUNDERBIRD PRODUCTS
		P.O. BOX 1003
MOD.: 330 CBR	DR BY: KPP	DECATUR IN., 46733
NO.: 56	DATE: 7-1-15	(260) 724-9111

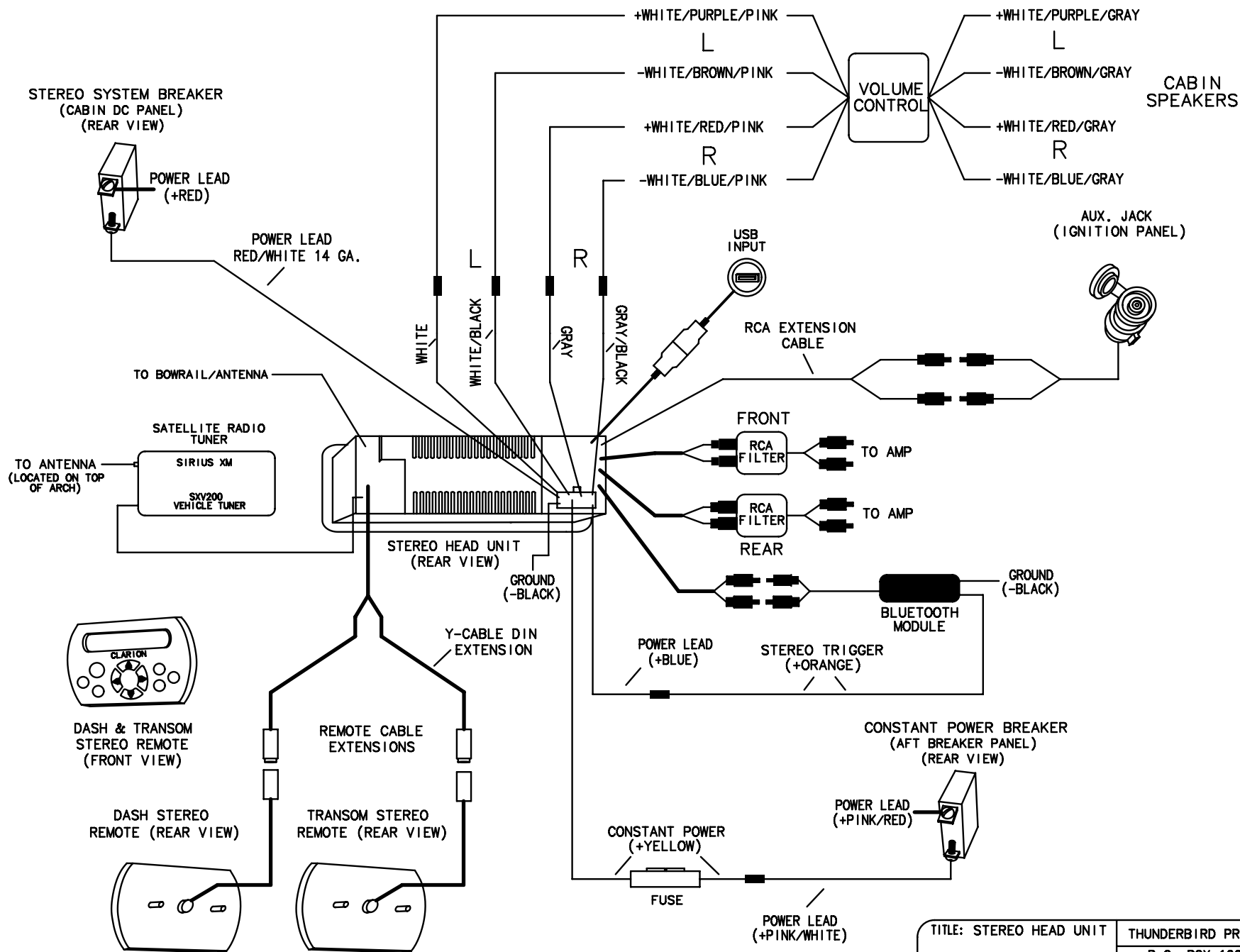

TITLE: STEREO HEAD UNIT		THUNDERBIRD PRODUCTS
		P.O. BOX 1003
MOD.: 330 CBR	DR BY: KPP	DECATUR IN., 46733
NO.: 57	DATE: 7-1-15	(260) 724-9111

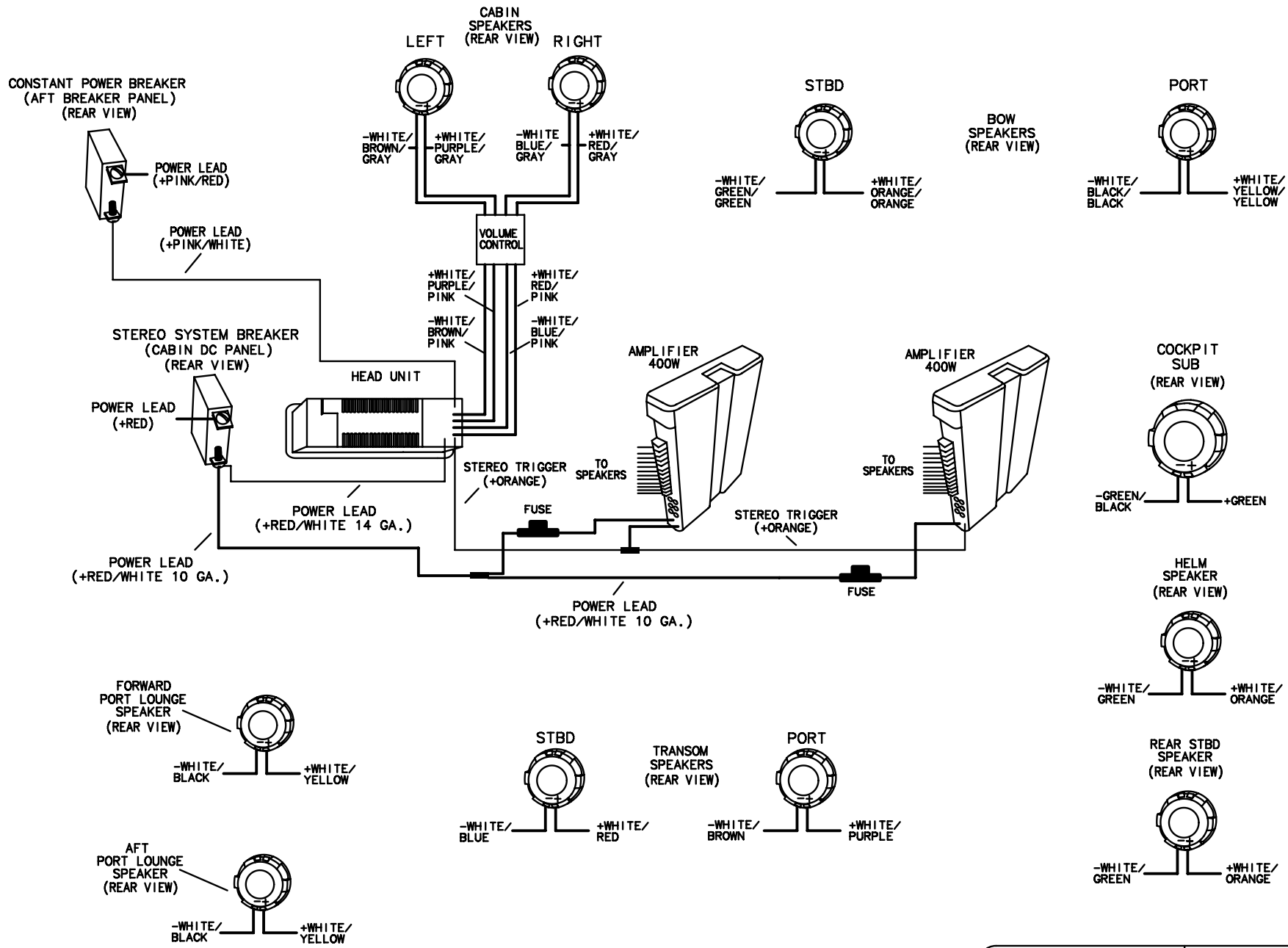

TITLE: STEREO SPEAKERS		THUNDERBIRD PRODUCTS
		P.O. BOX 1003
MOD.: 330 CBR	DR BY: KPP	DECATUR IN., 46733
NO.: 58	DATE: 7-1-15	(260) 724-9111

LEGEND

C-BREAKER PANEL 

PLUG INTERCONNECT 

TRIM TAB BREAKER
(DASH BREAKER PANEL)
(REAR VIEW)

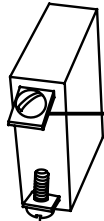

POWER LEAD
(+RED)

POWER LEAD
(+ORANGE)

TRIM TABS PUMP
(STBD SIDE)

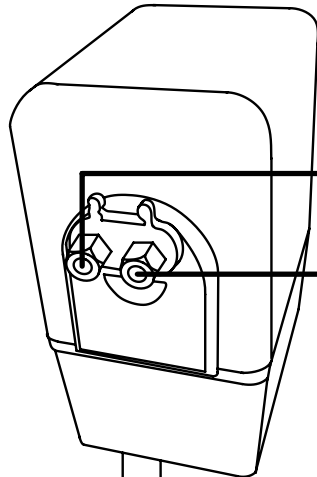

GROUND
(- BLACK)

EIC RELAY MODULE
(LOCATED BESIDE TRIM TAB PUMP)

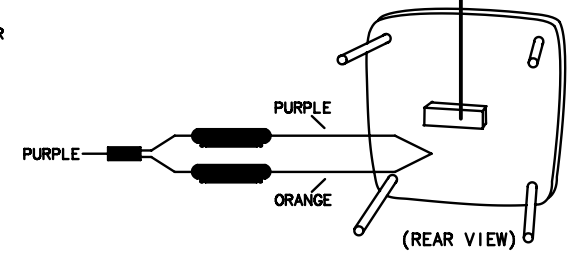
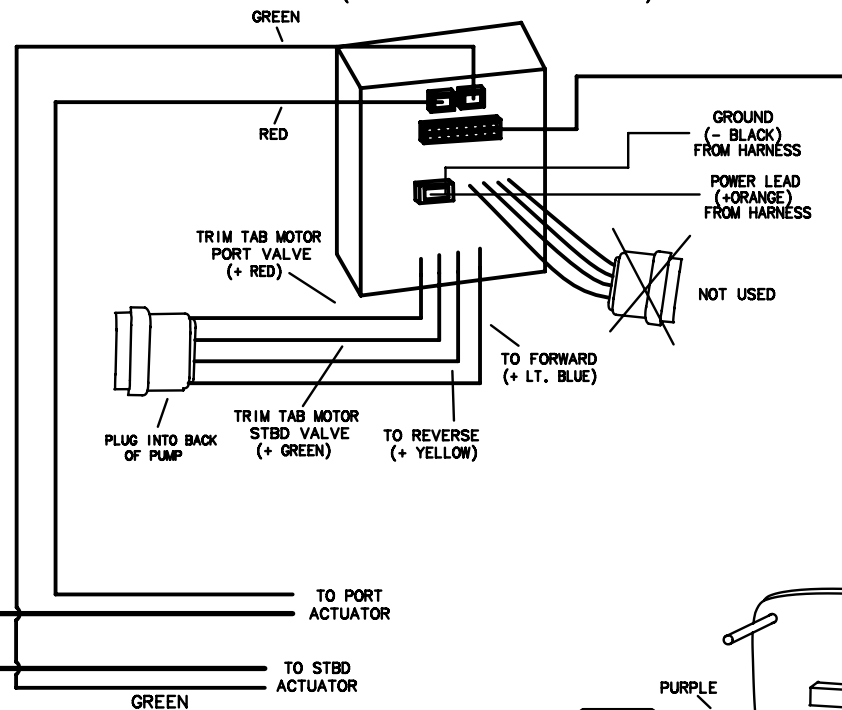

TRIM TAB CONTROL PAD
(FRONT VIEW)

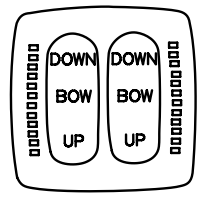

NOTE:
THE EIC WIRE HARNESS (GRAY)
RUNS WITH THE DECK HARNESS
TO THE TRIM TAB CONTROL
SWITCHES AT THE HELM.

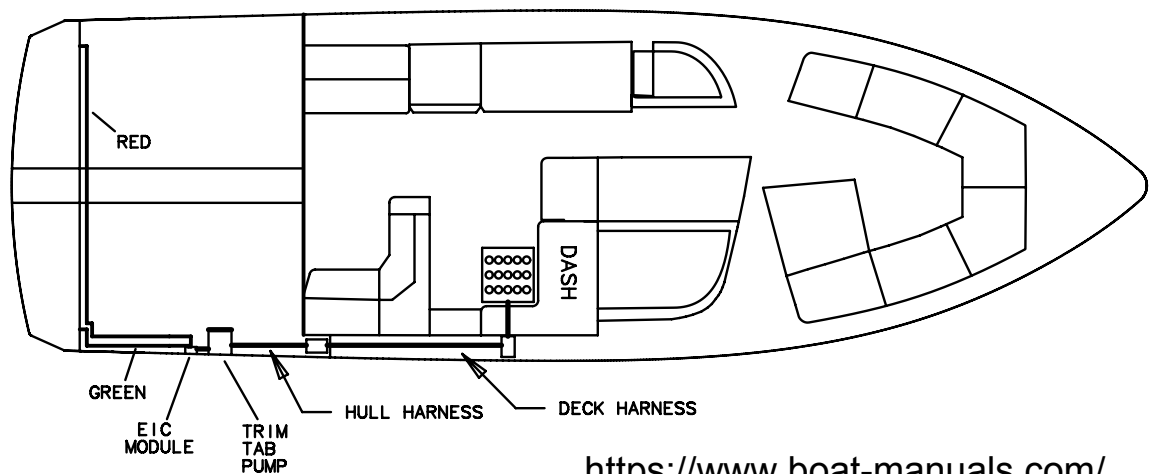

TITLE: TRIM TABS		THUNDERBIRD PRODUCTS	
		P.O. BOX 1003	
MOD.: 330 CBR	DR BY: KPP	DECATUR IN., 46733	
NO.: 59	DATE: 7-1-15	(260) 724-9111	

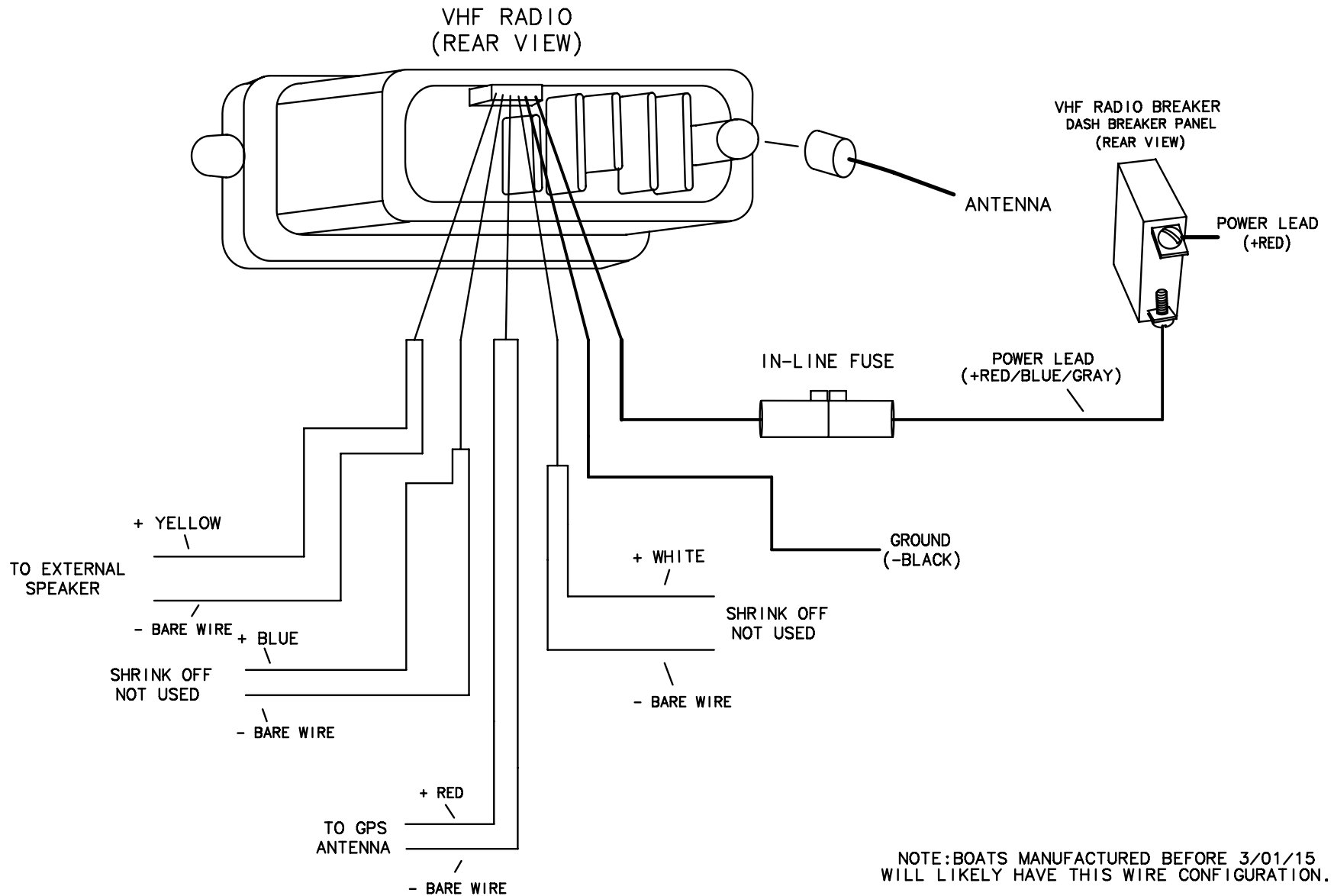

TITLE: VHF RADIO		THUNDERBIRD PRODUCTS
		P.O. BOX 1003
MOD.: 330 CBR	DR BY: KPP	DECATUR IN., 46733
NO.: 60	DATE: 7-1-15	(260) 724-9111

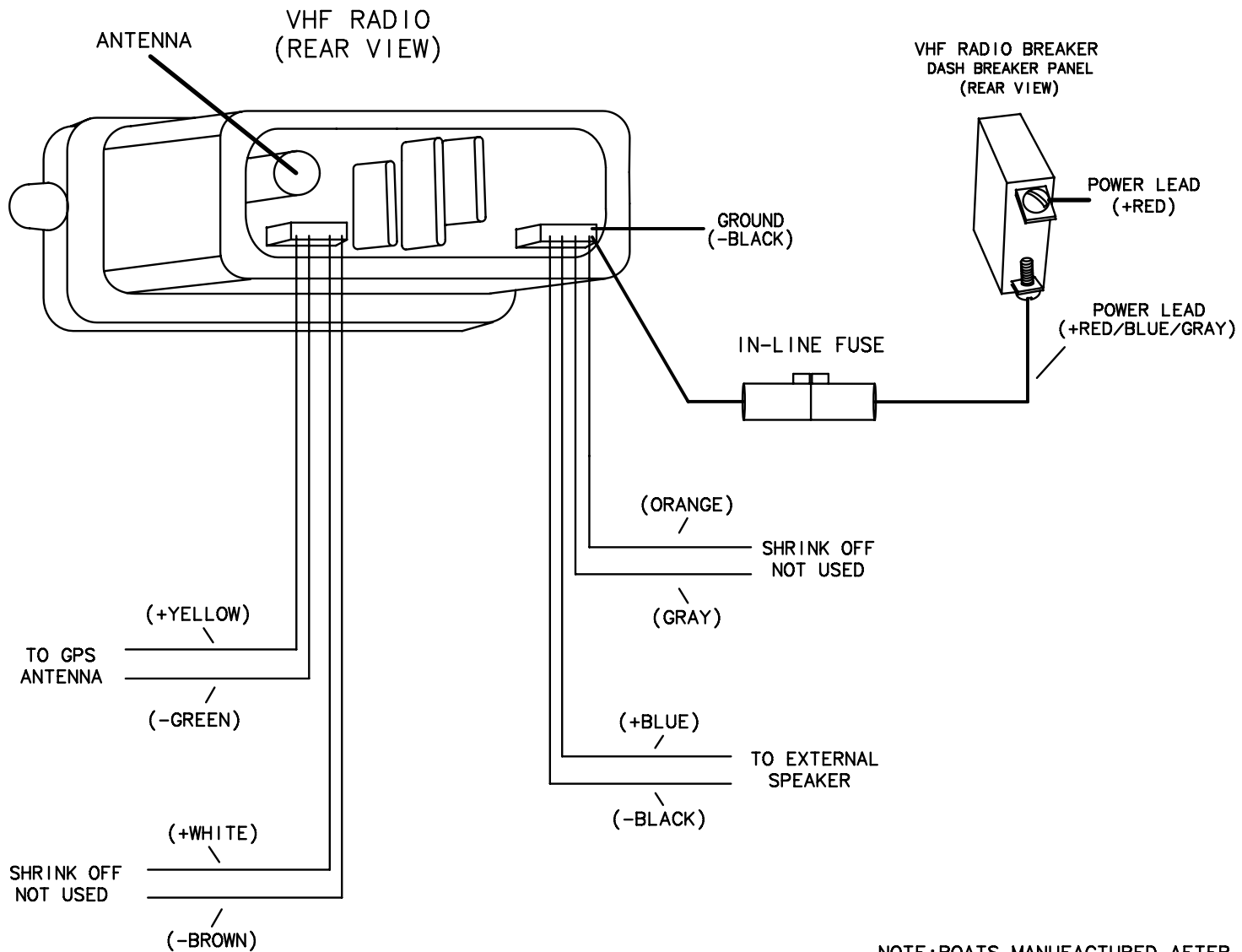

NOTE: BOATS MANUFACTURED AFTER 3/01/15 WILL LIKELY HAVE THIS WIRE CONFIGURATION.

TITLE: VHF RADIO		THUNDERBIRD PRODUCTS
		P.O. BOX 1003
MOD.: 330 CBR	DR BY: KPP	DECATUR IN., 46733
NO.: 61	DATE: 7-1-15	(260) 724-9111

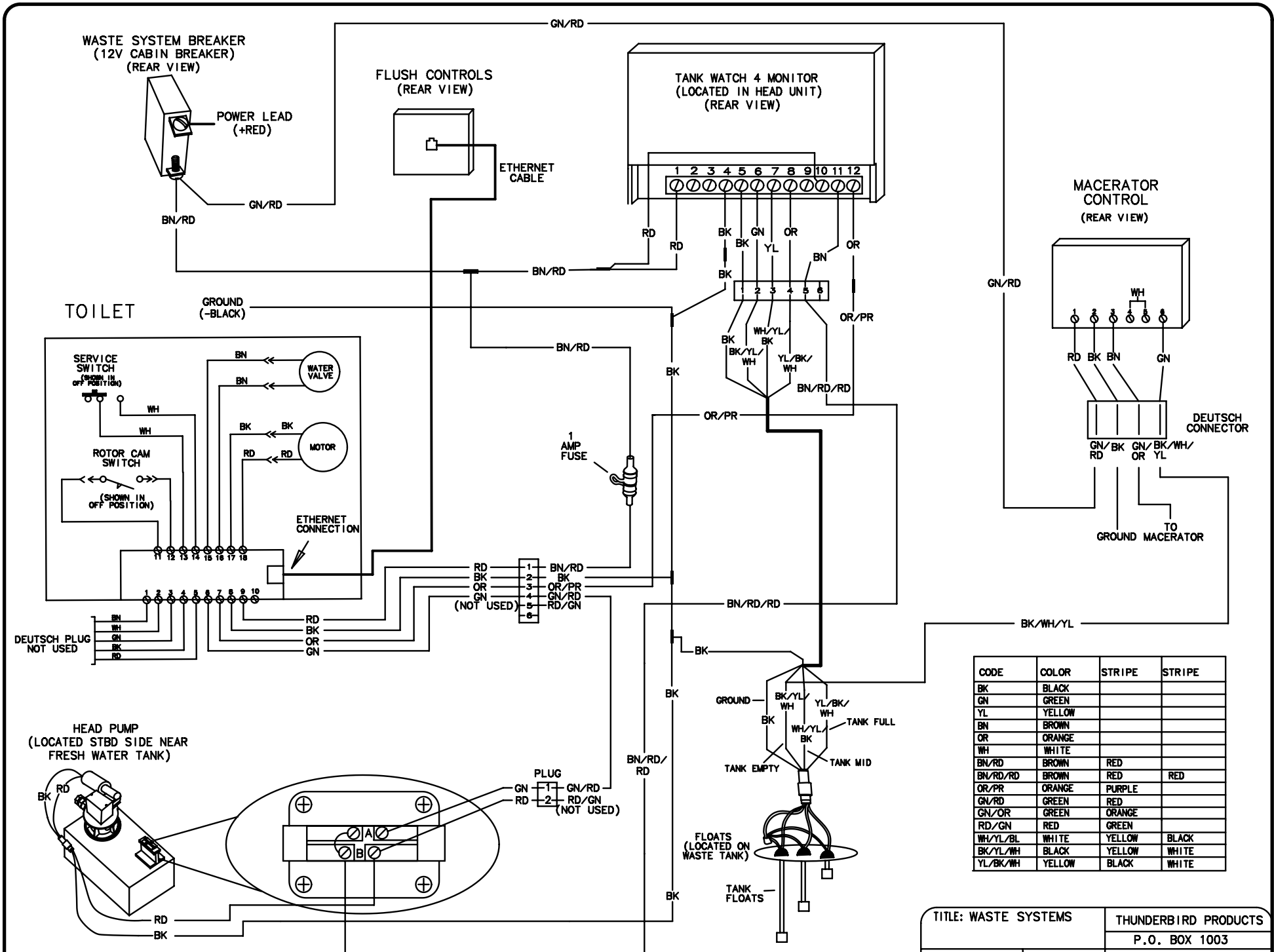

LEGEND

BREAKER PANEL	
LIGHT	
PLUG INTERCONNECT	
GROUND	

WATER LEVEL GAUGE (REAR VIEW)

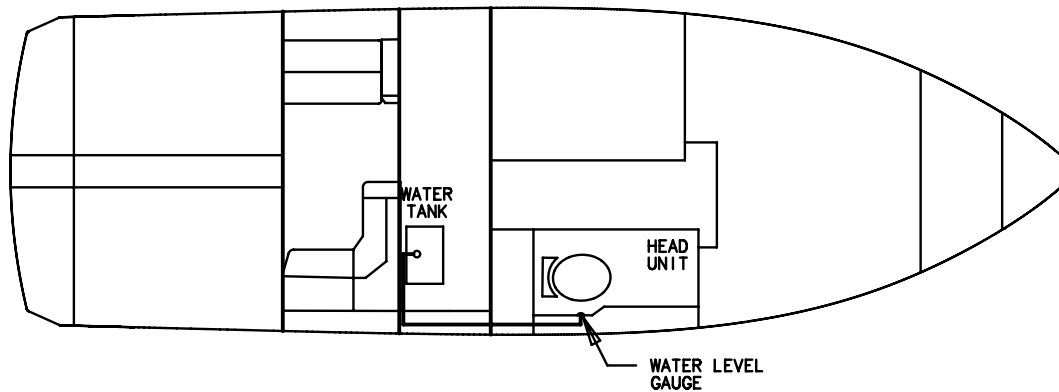
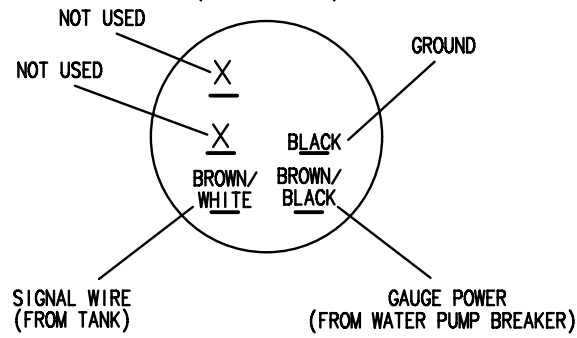

TITLE: WATER LEVEL GAUGE		THUNDERBIRD PRODUCTS
		P.O. BOX 1003
MOD.: 330 CBR	DR BY: KPP	DECATUR IN., 46733
NO.: 63	DATE: 7-1-15	(260) 724-9111

LEGEND

MOTOR (M)

GROUND (⏏)

CABIN DC PANEL (⏏⏏⏏⏏⏏⏏⏏)

PLUG INTERCONNECT (□ □)

WATER PUMP BREAKER
(CABIN DC PANEL)
(REAR VIEW)

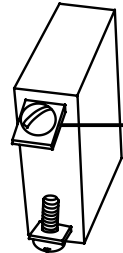

POWER LEAD
(+RED)

GROUND
(-BLACK)

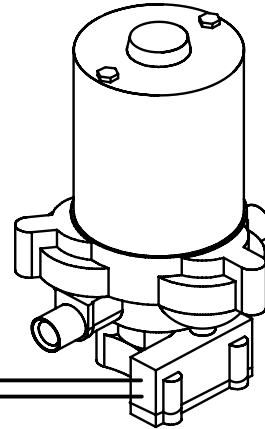

WATER PUMP
(LOCATED IN
LAZARETTE)

POWER LEAD
(+BROWN/BLACK)

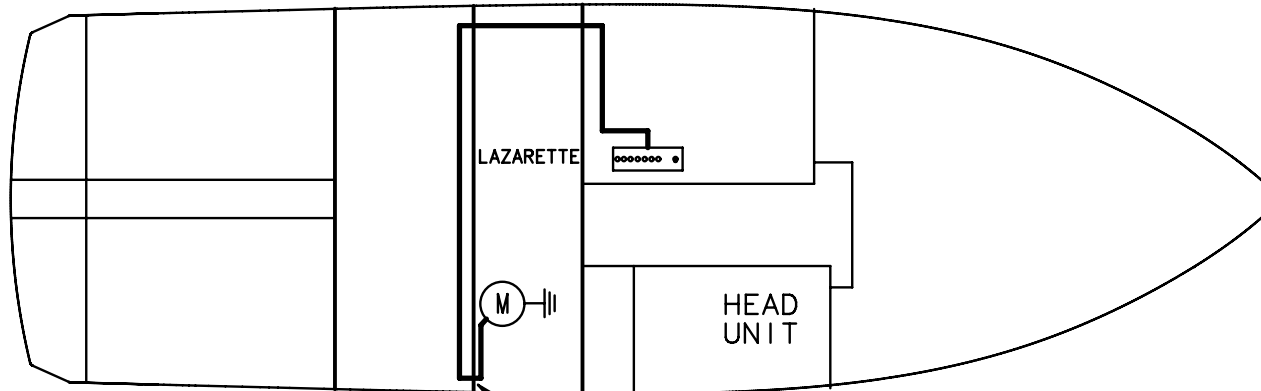

LAZARETTE

(M)

HEAD
UNIT

HULL HARNESS

TITLE: WATER PUMP (ELECTRICAL)		THUNDERBIRD PRODUCTS
		P.O. BOX 1003
MOD.: 330 CBR	DR BY: KPP	DECATUR IN., 46733
NO.: 64	DATE: 7-1-15	(260) 724-9111

LEGEND

C-BREAKER PANEL



MOTOR



PLUG INTERCONNECT



GROUND



BATTERY



CODE	COLOR	STRIPE	STRIPE
BK	BLACK		
BL	BLUE		
BN	BROWN		
WH	WHITE		
OR/BL	ORANGE	BLUE	
OR/BL/BL	ORANGE	BLUE	BLUE
OR/YL/YL	ORANGE	YELLOW	YELLOW
OR/YL/RD	ORANGE	YELLOW	RED

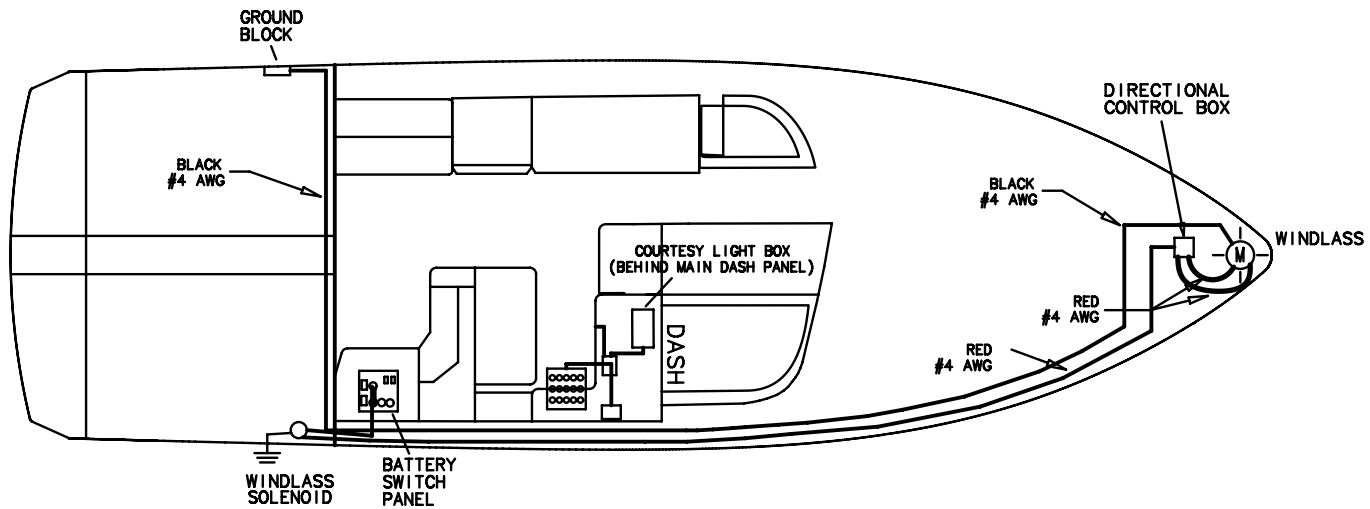
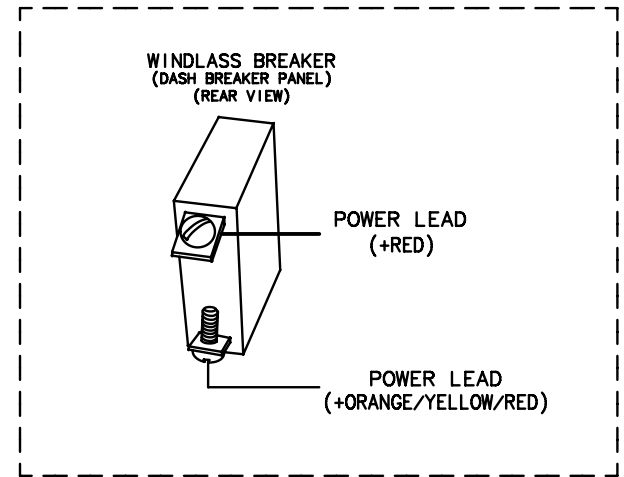
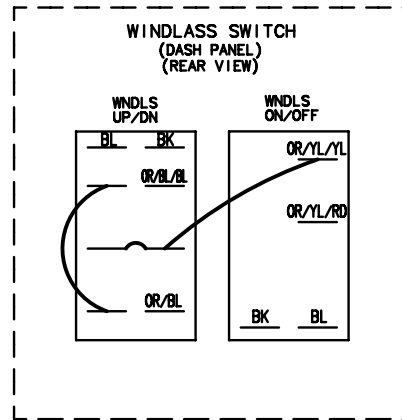

TITLE: WINDLASS		THUNDERBIRD PRODUCTS
		P.O. BOX 1003
MOD.: 330 CBR	DR BY: KPP	DECATUR IN., 46733
NO.: 65	DATE: 7-1-15	(260) 724-9111

CODE	COLOR	STRIPE	STRIPE
BK	BLACK		
BL	BLUE		
RD	RED		
BN	BROWN		
GY	GRAY		
YL	YELLOW		
WH	WHITE		
TN/GY	TAN	GRAY	
OR/BL	ORANGE	BLUE	
OR/BL/BL	ORANGE	BLUE	BLUE
OR/YL/YL	ORANGE	YELLOW	YELLOW
OR/YL/RD	ORANGE	YELLOW	RED

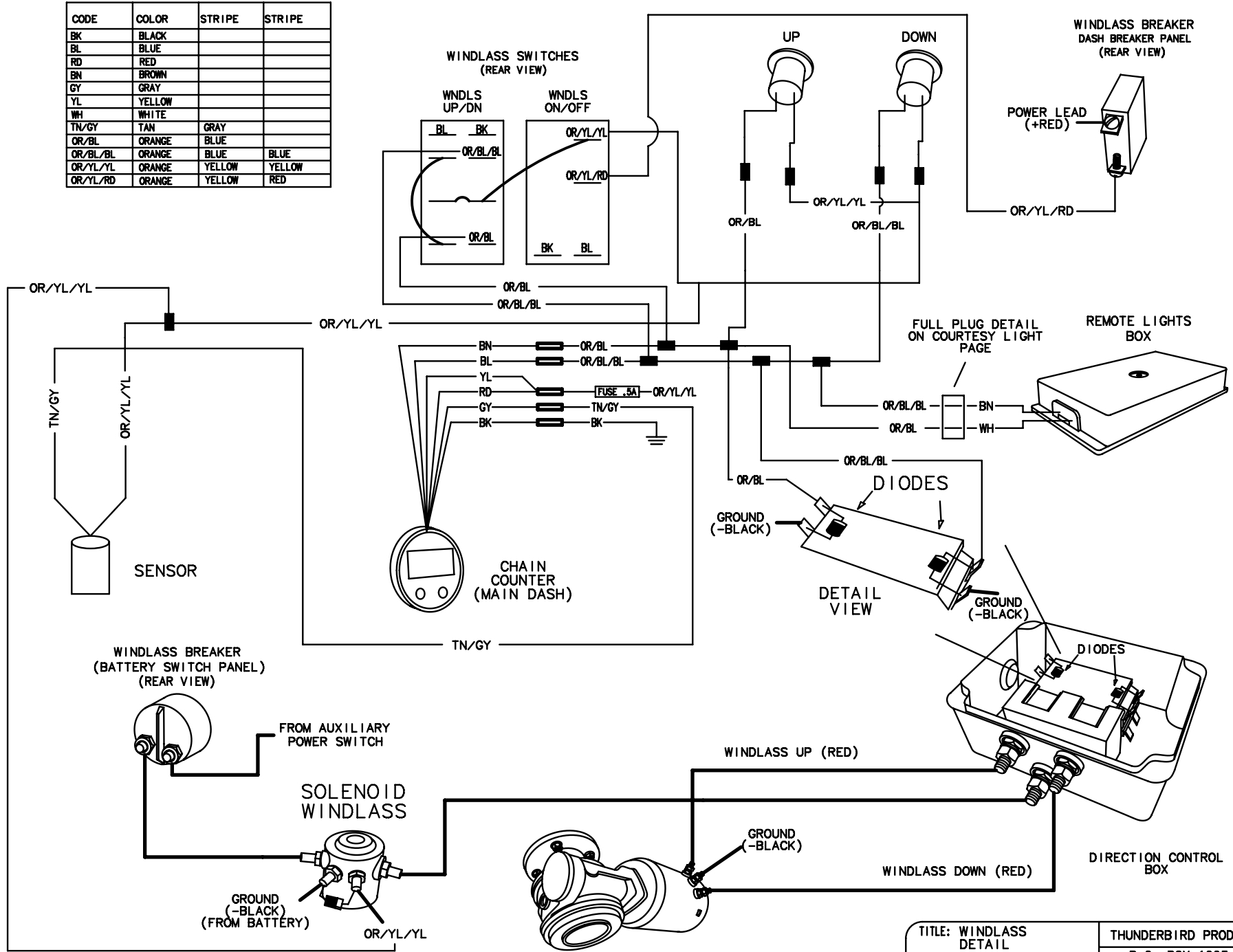

WINDLASS MOTOR
<https://www.boat-manuals.com/>

TITLE: WINDLASS DETAIL		THUNDERBIRD PRODUCTS	
		P.O. BOX 1003	
MOD.: 330 CBR	DR BY: KPP	DECATUR IN., 46733	
NO.: 66	DATE: 7-1-15	(260) 724-9111	

LEGEND

C-BREAKER PANEL 

MOTOR 

PLUG INTERCONNECT 

CONNECTOR 

GROUND 

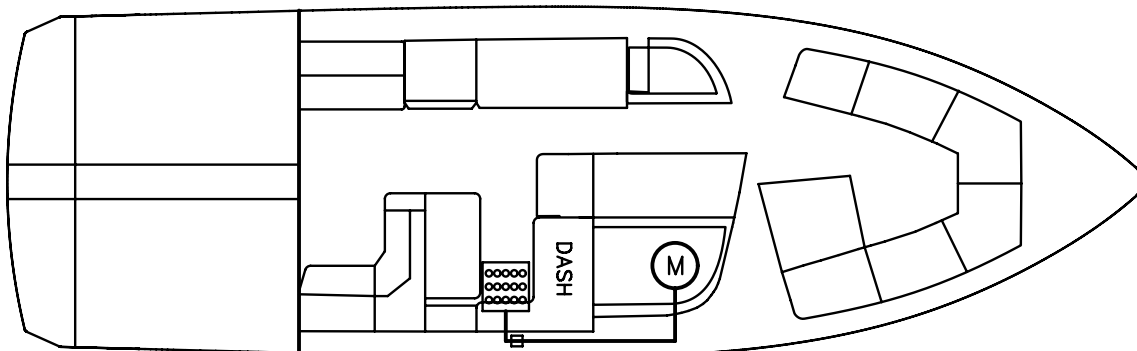
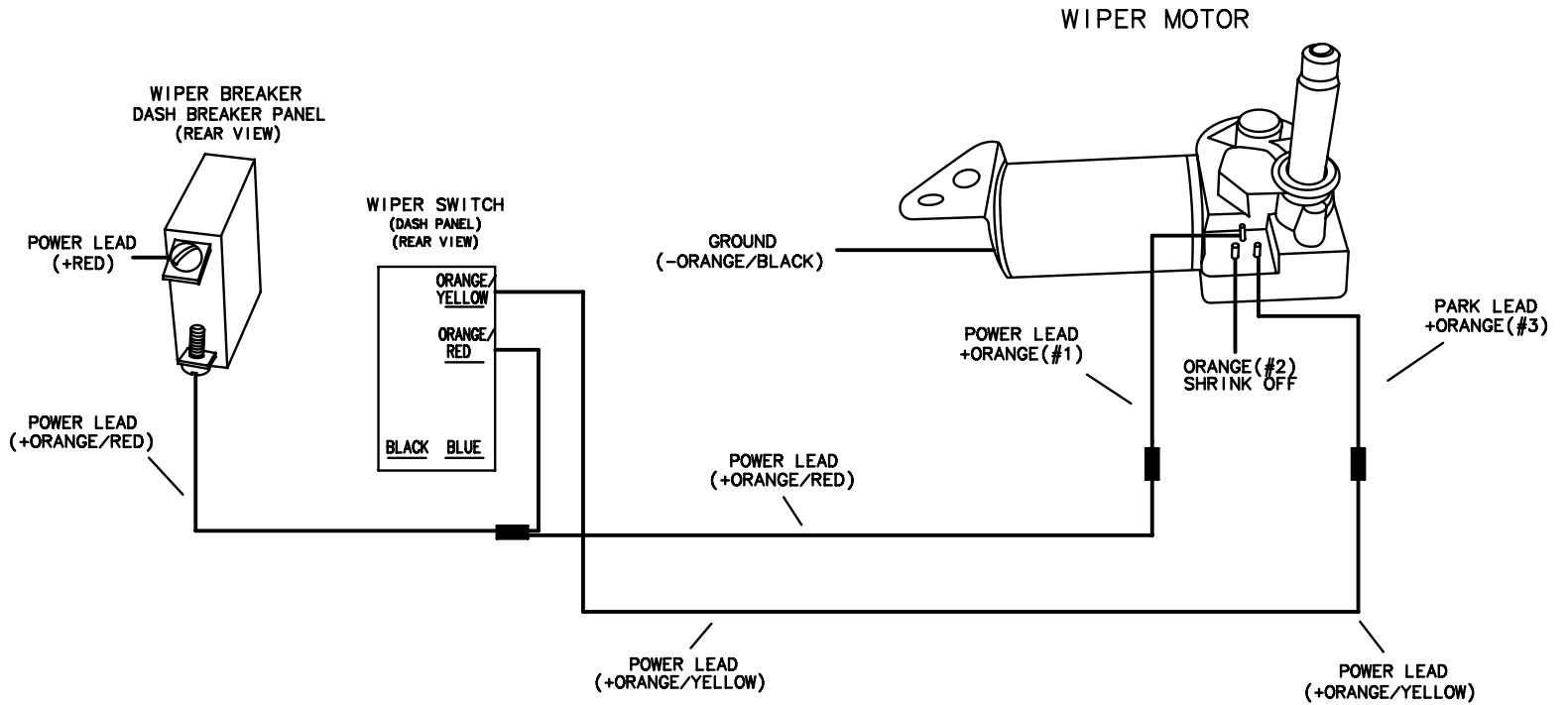

NOTE: ACCESS TO MOTOR IN CABIN
BEHIND CABIN CEILING MATERIAL.

<https://www.boat-manuals.com/>

TITLE: WIPER		THUNDERBIRD PRODUCTS
		P.O. BOX 1003
MOD.: 330 CBR	DR BY: KPP	DECATUR IN., 46733
NO.: 67	DATE: 7-1-15	(260) 724-9111

(REAR VIEW)

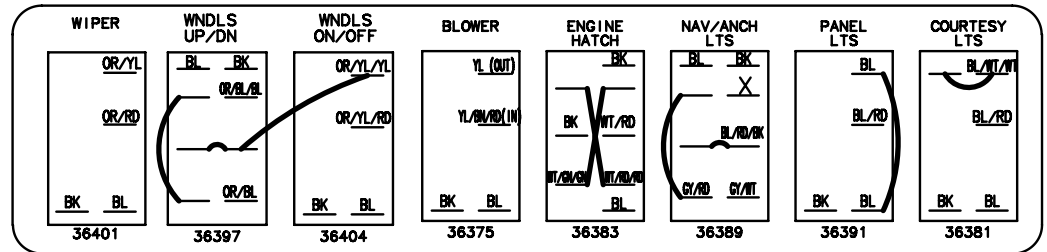
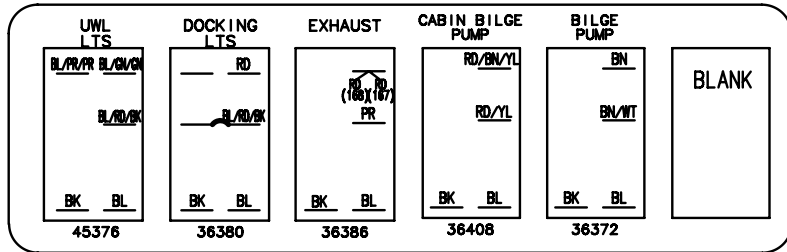

BLANKS ----->

WINDLASS WITH 3 ADDITIONAL OPTIONS

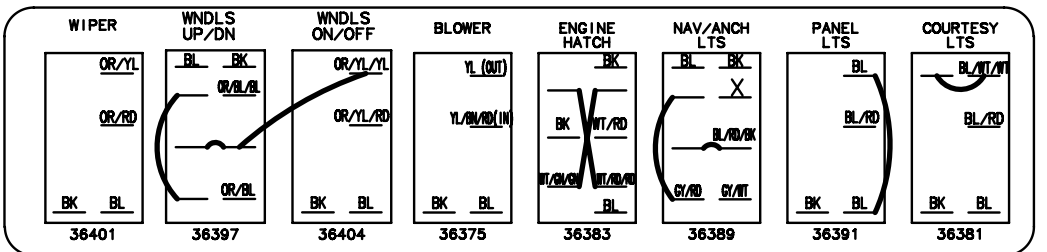
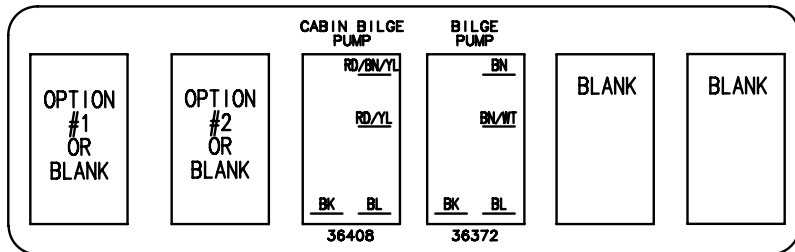

<----- OPTIONS

BLANKS ----->

WINDLASS WITH/WITHOUT 1 OR 2 ADDITIONAL OPTIONS

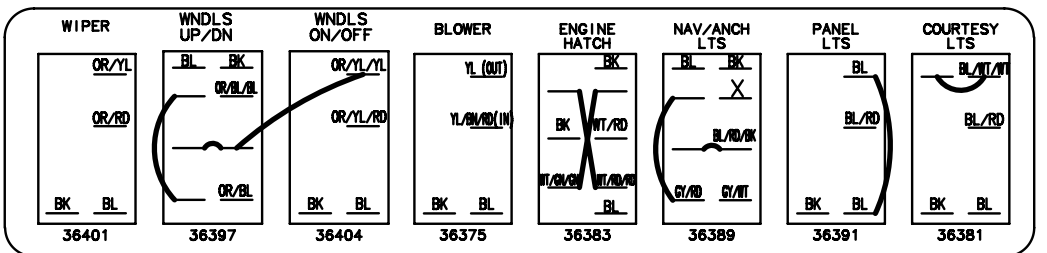
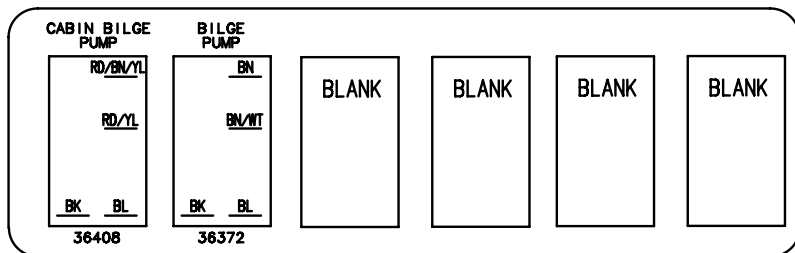

BLANKS ----->

NO ADDITIONAL OPTIONS

TITLE: ACCESSORY PANEL		THUNDERBIRD PRODUCTS	
		P.O. BOX 1003	
MOD.: 330 CBR	DR BY: KPP	DECATUR IN., 46733	
NO.: 68	DATE: 7-1-15	(260) 724-9111	

AFT BREAKER PANEL

* STBD DTS CIRCUIT BREAKER IS USED WITH ALL GAS DTS ENGINES.

USED ONLY WITH E-SERIES VOLVO EVC OR DIESEL ENGINES.

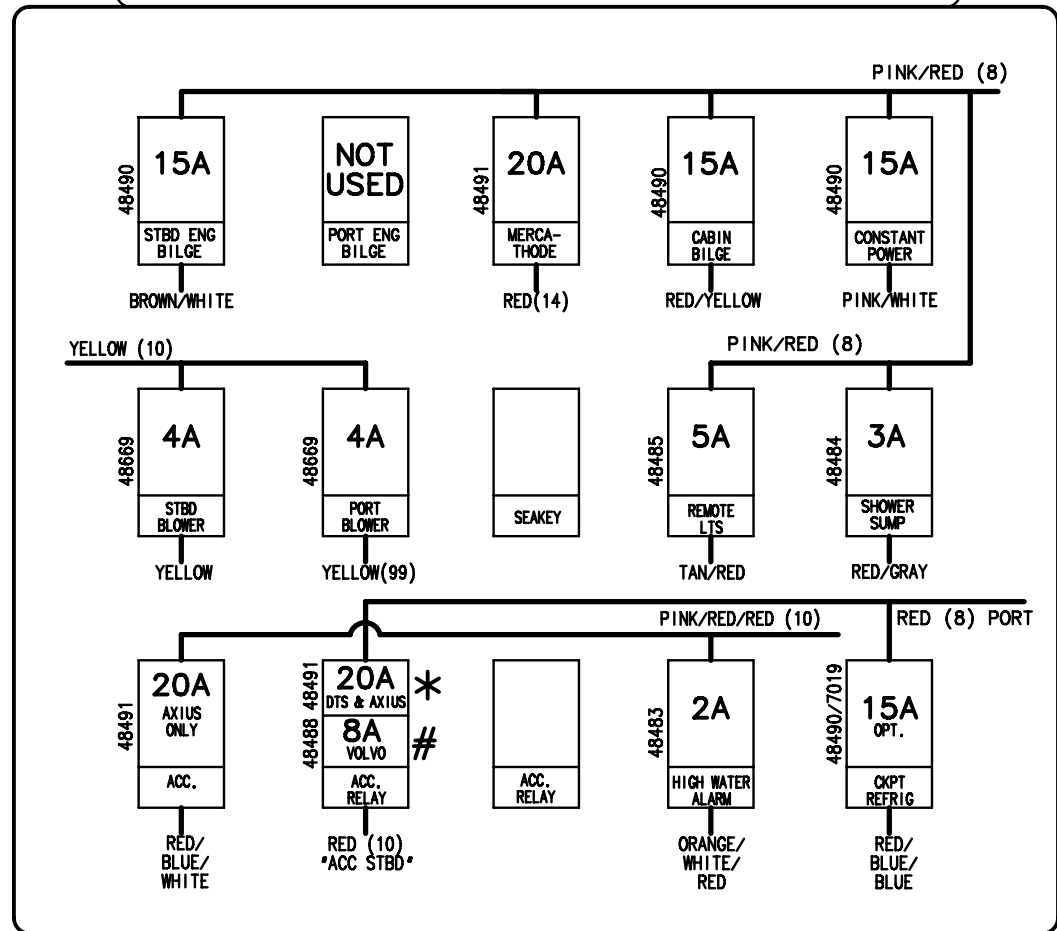

(REAR VIEW)

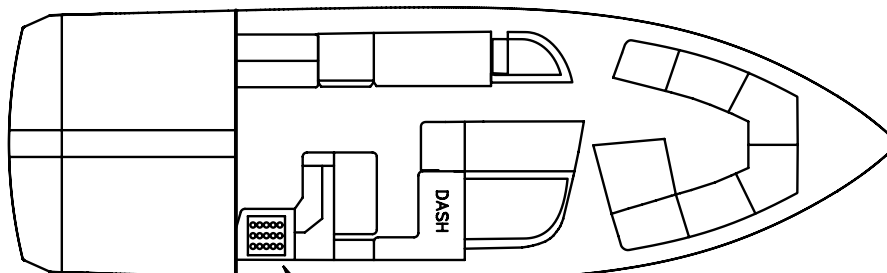

AFT BREAKER PANEL

BREAKER SIZES ARE SUBJECT TO CHANGE WITHOUT NOTICE.

<https://www.boat-manuals.com/>

TITLE: AFT BREAKER PANEL		THUNDERBIRD PRODUCTS	
		P.O. BOX 1003	
MOD.: 330 CBR	DR BY: KPP	DECATUR IN., 46733	
NO.: 69	DATE: 7-1-15	(260) 724-9111	

BATTERY SWITCH PANEL
(LOCATED UNDER STARBOARD AFT SEAT)
(REAR VIEW)

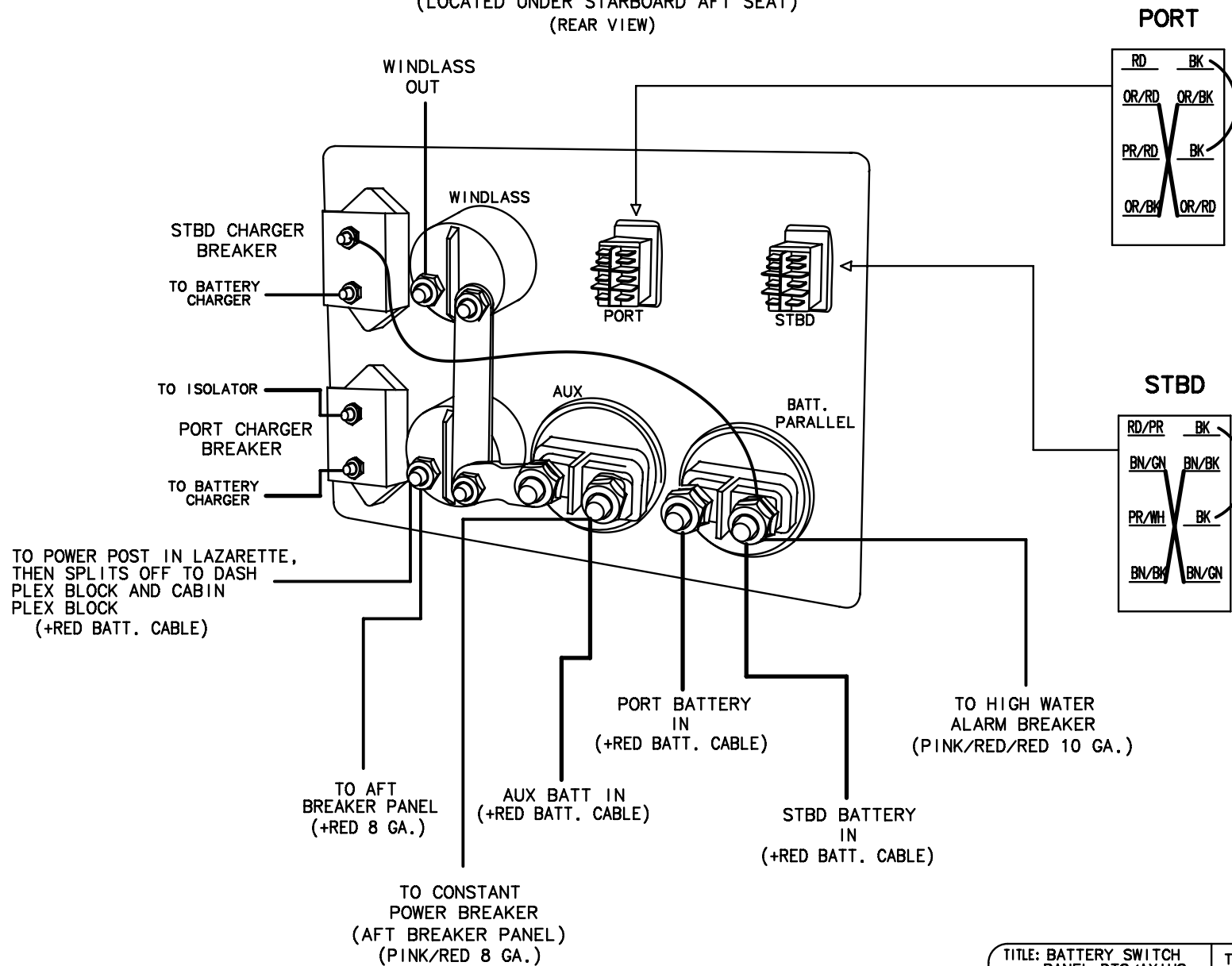

TITLE: BATTERY SWITCH PANEL DTS/AXIUS		THUNDERBIRD PRODUCTS
		P.O. BOX 1003
MOD.: 330 CBR	DR BY: KPP	DECATUR IN., 46733
NO.: 70	DATE: 7-1-15	(260) 724-9111

**BATTERY PARALLEL
SWITCH PANEL**
(LOCATED UNDER STARBOARD AFT SEAT)
(REAR VIEW))

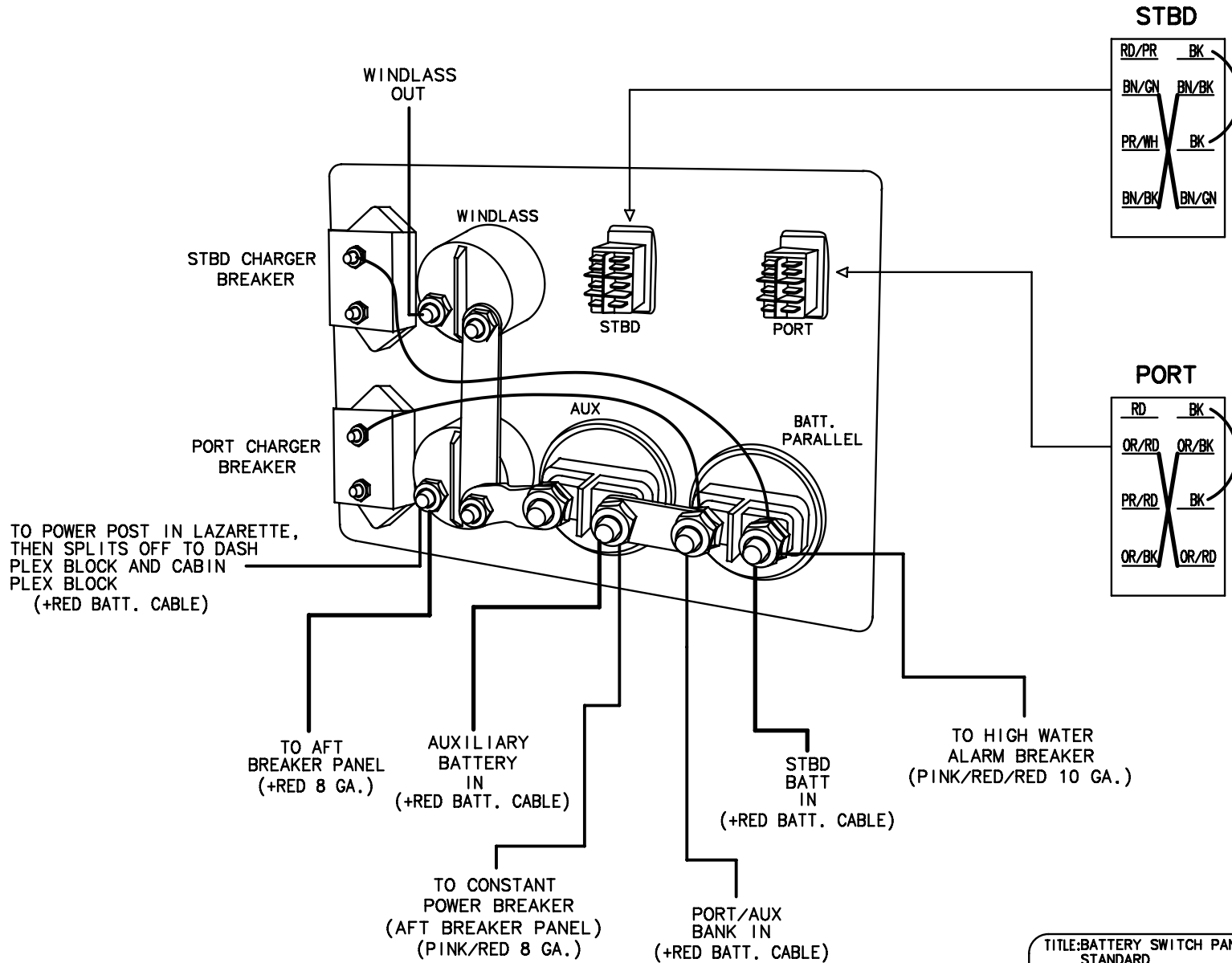

TITLE: BATTERY SWITCH PANEL STANDARD		THUNDERBIRD PRODUCTS
		P.O. BOX 1003
MOD.: 330 CBR	DR BY: KPP	DECATUR IN., 46733
NO.: 71	DATE: 7-1-15	(260) 724-9111

CABIN DC PANEL (REAR VIEW)

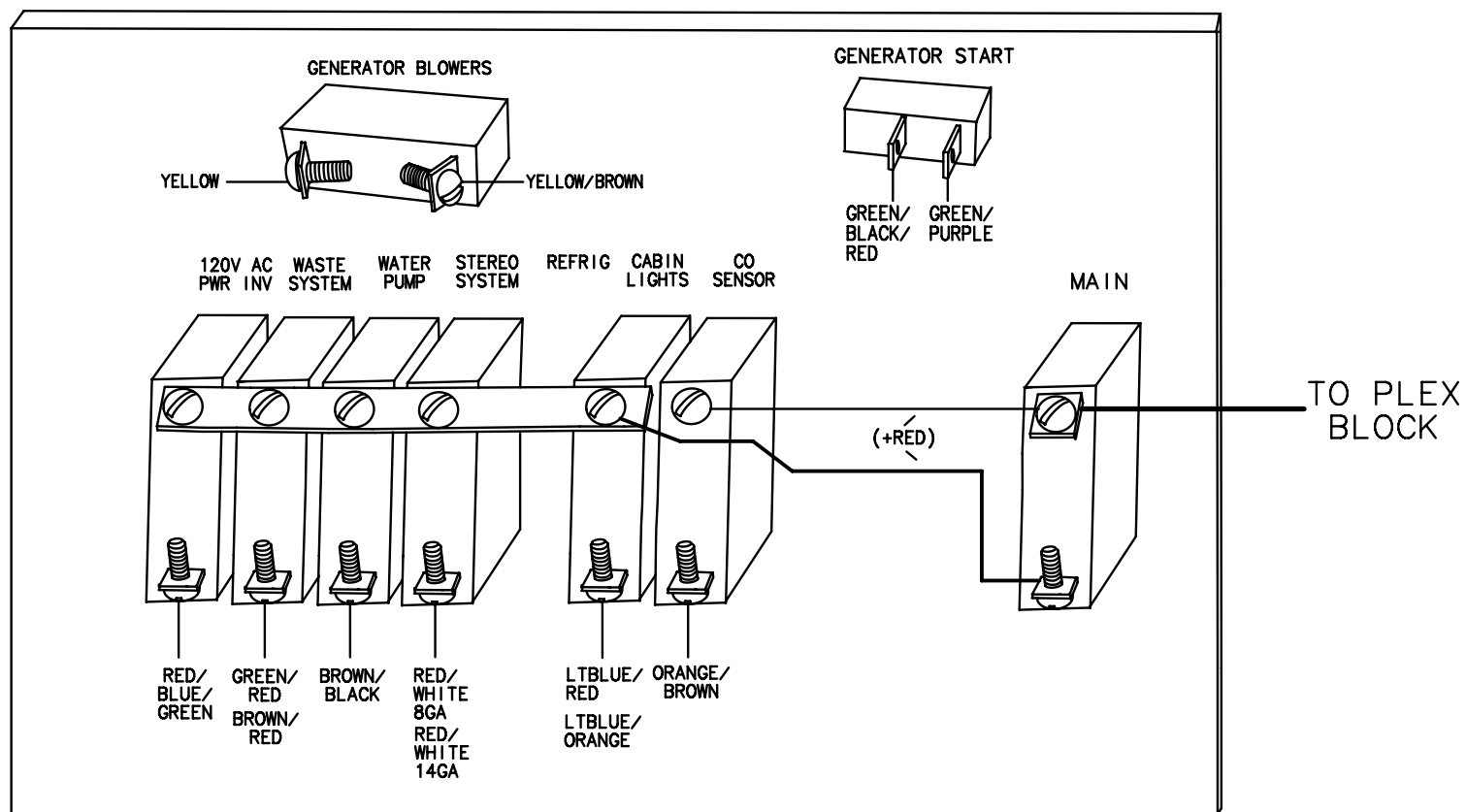

TITLE: CABIN DC PANEL		THUNDERBIRD PRODUCTS
		P.O. BOX 1003
MOD.: 330 CBR	DR BY: KPP	DECATUR IN., 46733
NO.: 72	DATE: 7-1-15	(260) 724-9111

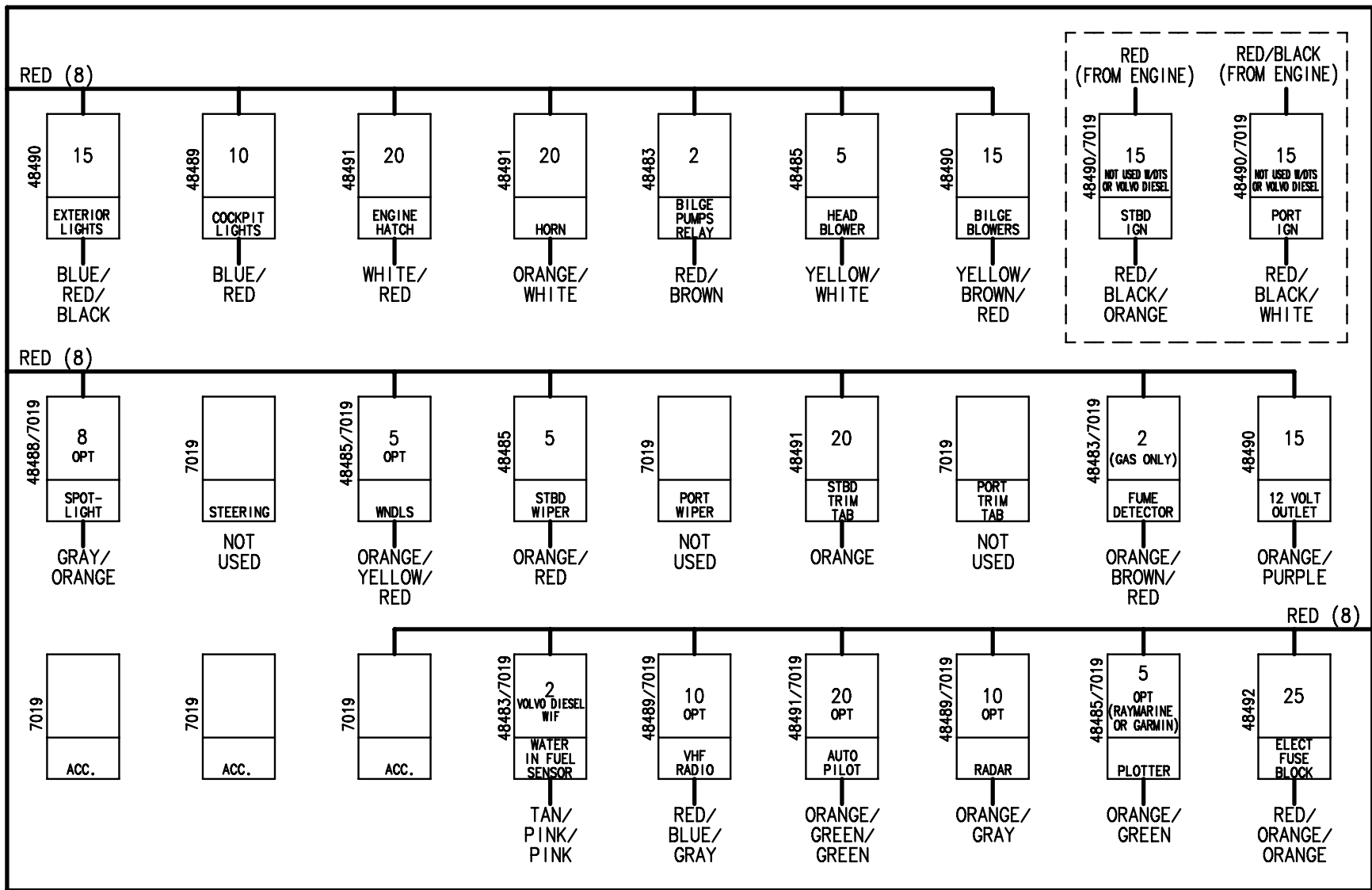

(REAR VIEW)

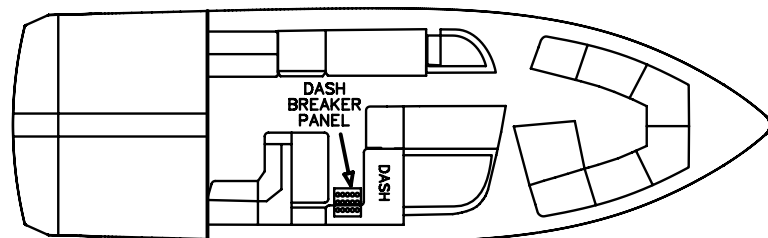

BREAKER SIZES ARE SUBJECT TO CHANGE WITHOUT NOTICE.

GAS IGNITION PANEL (REAR VIEW)

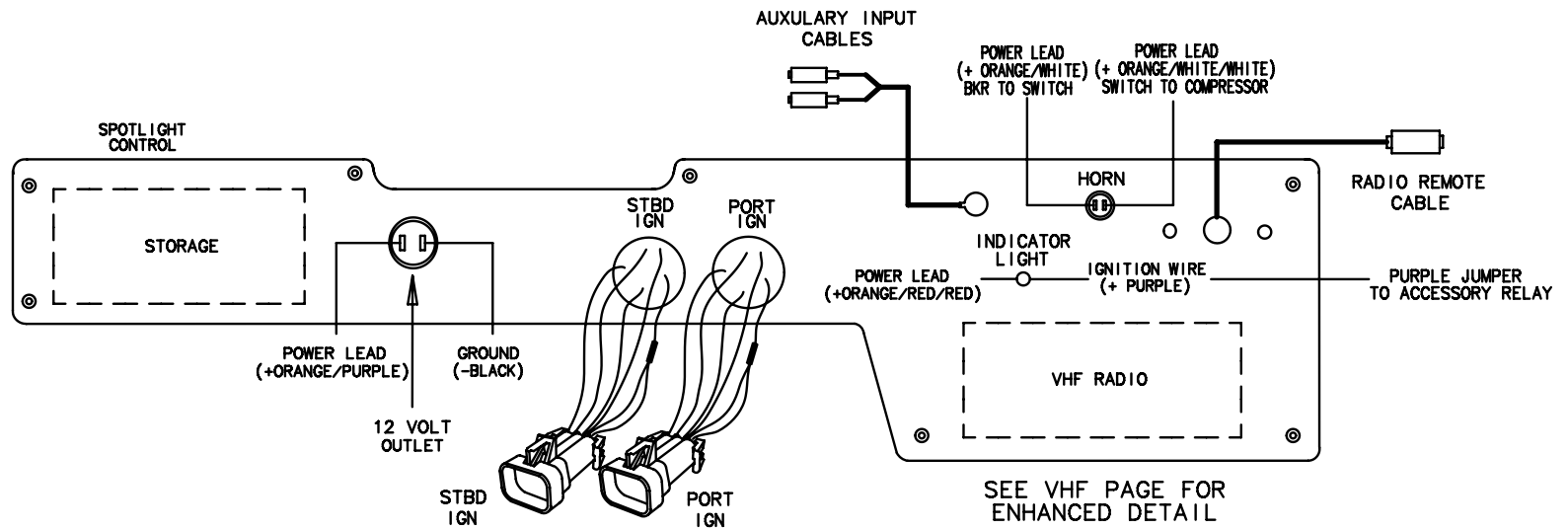

TITLE: IGNITION PANEL AXIUS/DTS		THUNDERBIRD PRODUCTS
		P.O. BOX 1003
MOD.: 330 CBR	DR BY: KPP	DECATUR IN., 46733
NO.: 74	DATE: 7-1-15	(260) 724-9111

GAS IGNITION PANEL (REAR VIEW)

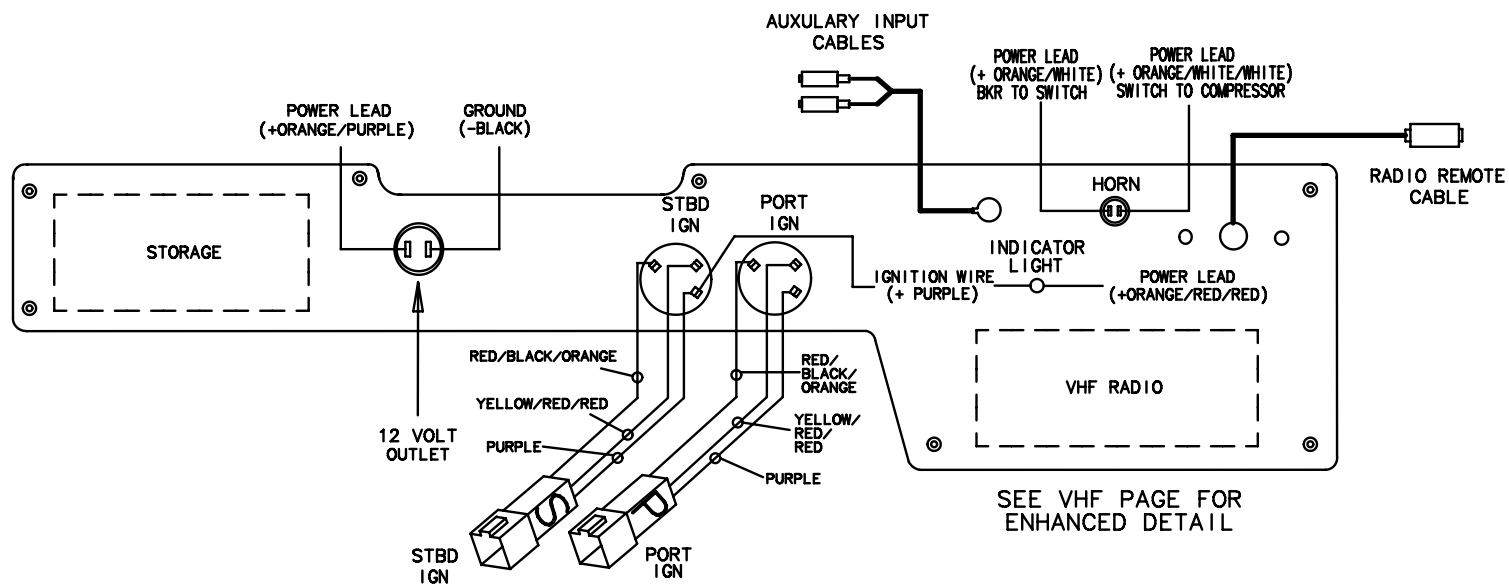

TITLE: IGNITION PANEL STANDARD		THUNDERBIRD PRODUCTS
		P.O. BOX 1003
MOD.: 330 CBR	DR BY: KPP	DECATUR IN., 46733
NO.: 75	DATE: 7-1-15	(260) 724-9111

MAIN DASH PANEL (REAR VIEW)

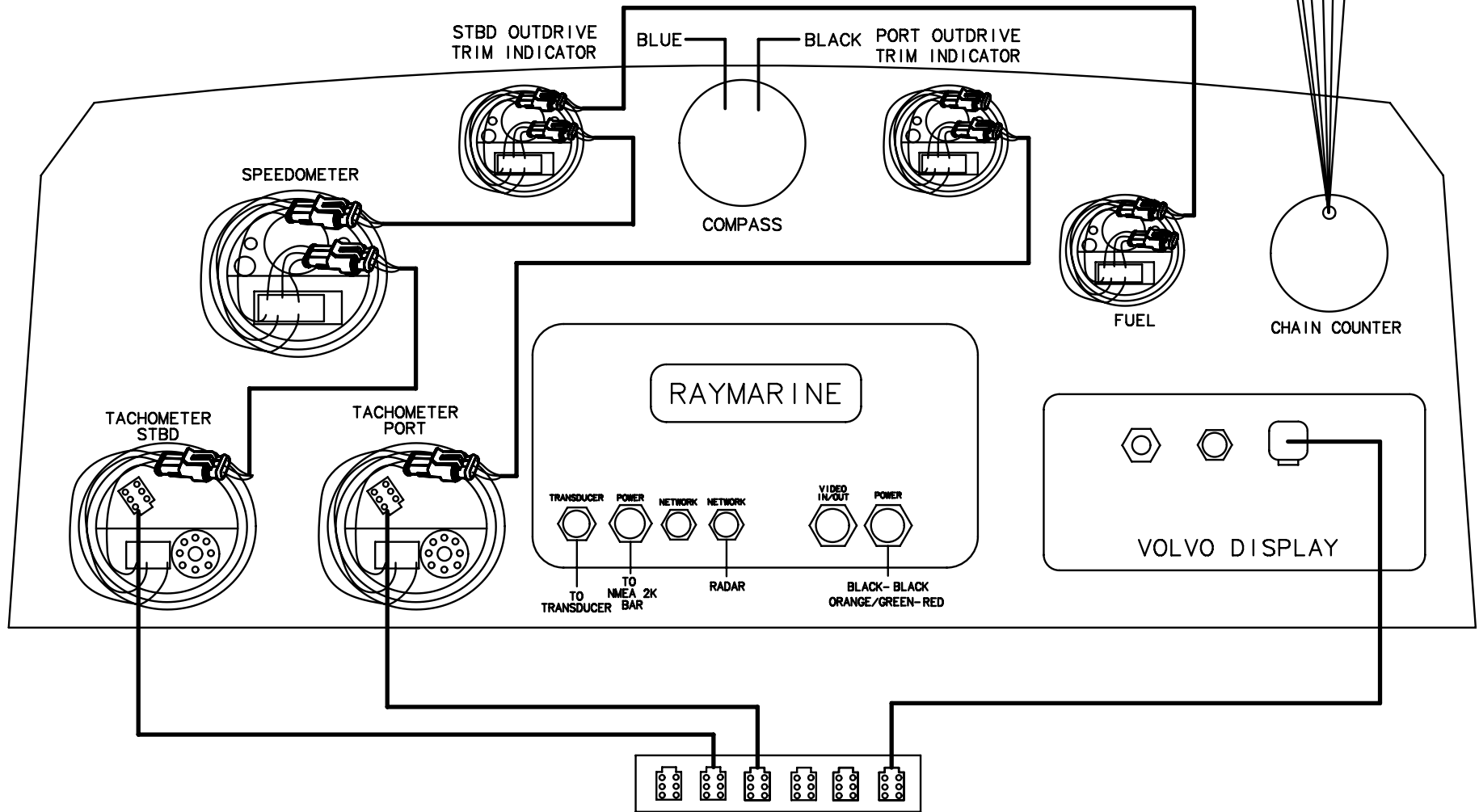
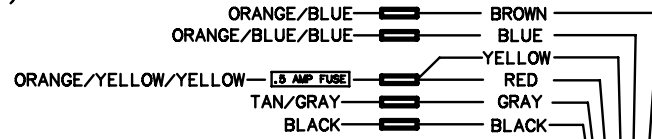

NOTE: ALL PORT AND STBD GAUGES MUST BE KEPT SEPERATE. WITH FUEL ON STBD.

TITLE: MAIN PANEL W/CHARTPLOTTER AND EVC		THUNDERBIRD PRODUCTS
MOD.: 330 CBR		P.O. BOX 1003
DR BY: KPP	NO.: 76	DECATUR IN., 46733
DATE: 7-1-15		(260) 724-9111

(REAR VIEW)

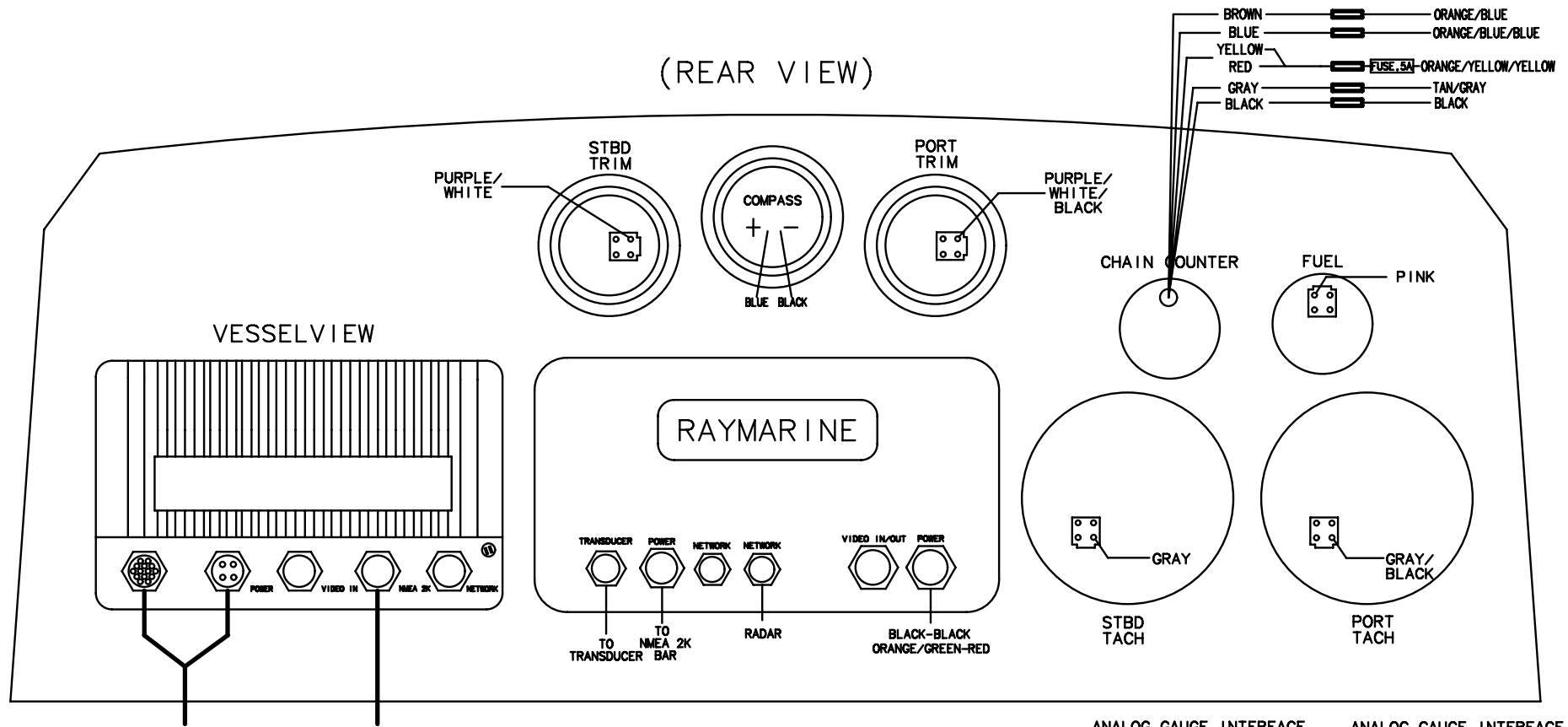

TO MERCURY J-BLOCK (LOCATED BEHIND MAIN DASH PANEL)
TO NMEA 2000 POWER BLOCK

TRANSDUCER TO NMEA 2K
POWER TO NMEA 2K BAR
NETWORK RADAR
VIDEO IN/OUT BLACK-BLACK
POWER ORANGE/GREEN-RED

ANALOG GAUGE INTERFACE (BEHIND MAIN PANEL)
ANALOG GAUGE INTERFACE (BEHIND MAIN PANEL)

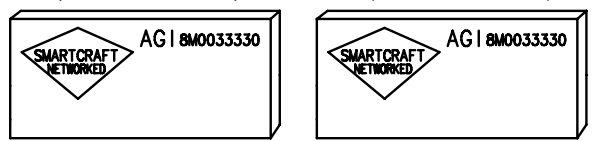

STARBOARD PORT

(CONNECT FROM HARNESS TO GREEN SIGNAL WIRE)

OUTPUTS	COLOR
TACHOMETER	GRAY
FUEL LEVEL	PINK/BLACK
TRIM POSITION	BROWN/WHITE
BLOCK TEMPERATURE	TAN
OIL PRESSURE	BLUE

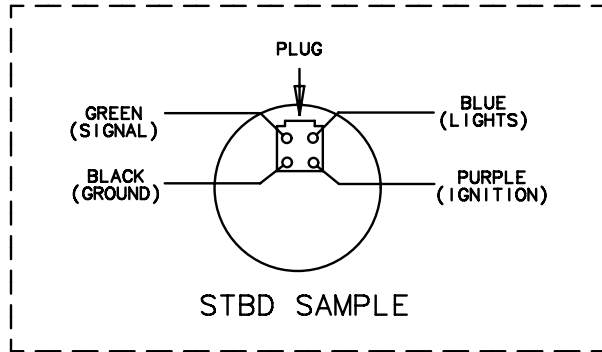

NOTE: FUEL WILL USE STBD IGNITION WIRE (PURPLE).
ALL PORT INSTRUMENTS WILL USE PORT IGNITION WIRE (PURPLE/BLACK).

TITLE: MAIN PANEL (LIVORSI MONSTER GAUGES)		THUNDERBIRD PRODUCTS
		P.O. BOX 1003
MOD.: 330 CBR	DR BY: KPP	DECATUR IN., 46733
NO.: 77	DATE: 7-1-15	(260) 724-9111

MAIN DASH PANEL (REAR VIEW)

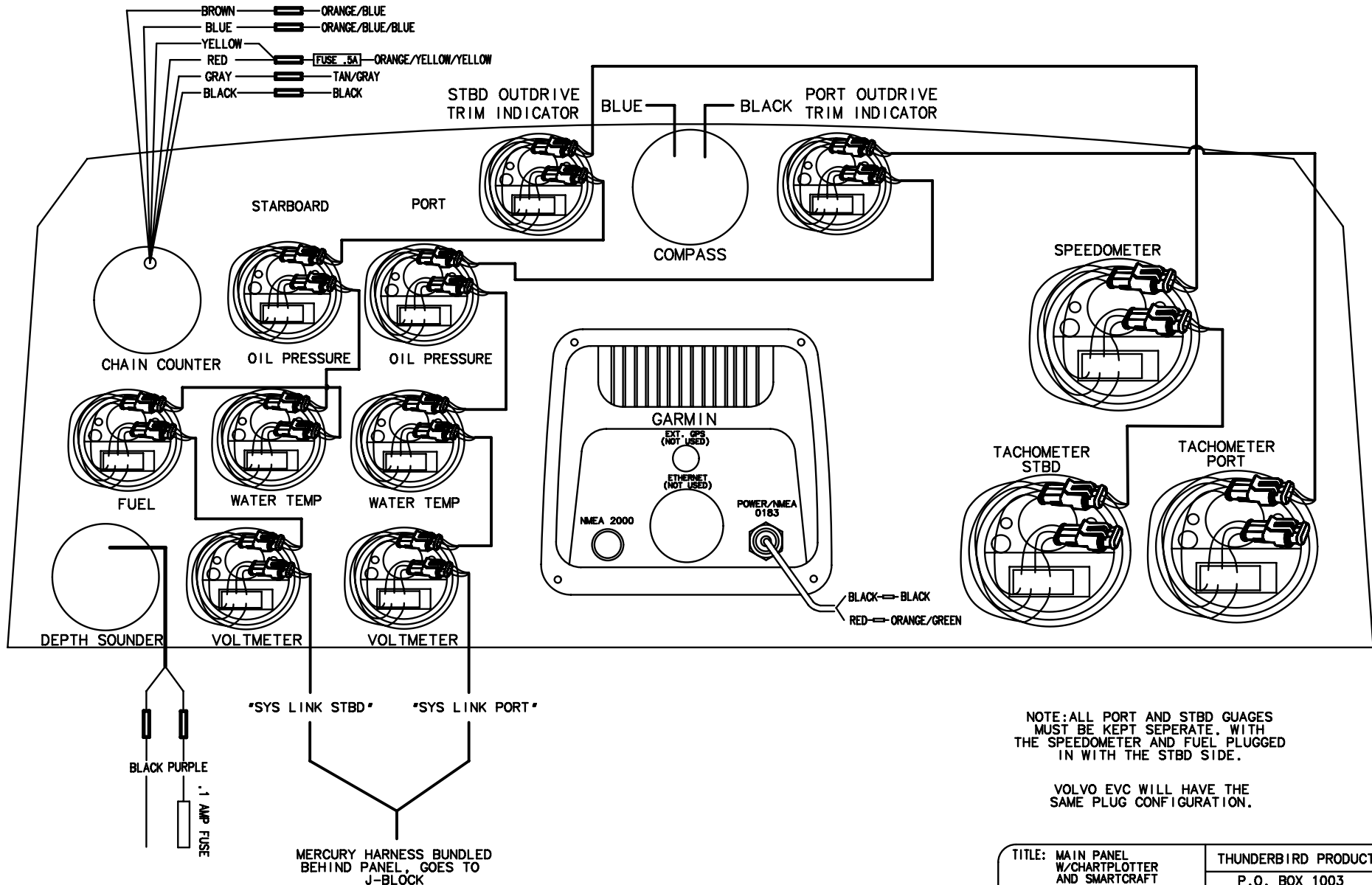

NOTE: ALL PORT AND STBD GAUGES MUST BE KEPT SEPERATE, WITH THE SPEEDOMETER AND FUEL PLUGGED IN WITH THE STBD SIDE.

VOLVO EVC WILL HAVE THE SAME PLUG CONFIGURATION.

TITLE: MAIN PANEL W/CHARTPLOTTER AND SMARTCRAFT		THUNDERBIRD PRODUCTS
		P.O. BOX 1003
MOD.: 330 CBR	DR BY: KPP	DECATUR IN., 46733
NO.: 78	DATE: 7-1-15	(260) 724-9111

MAIN PANEL (REAR VIEW)

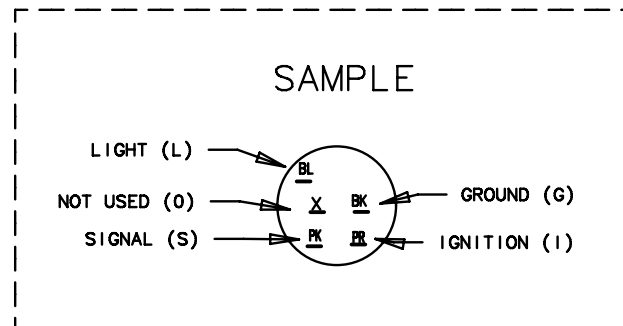
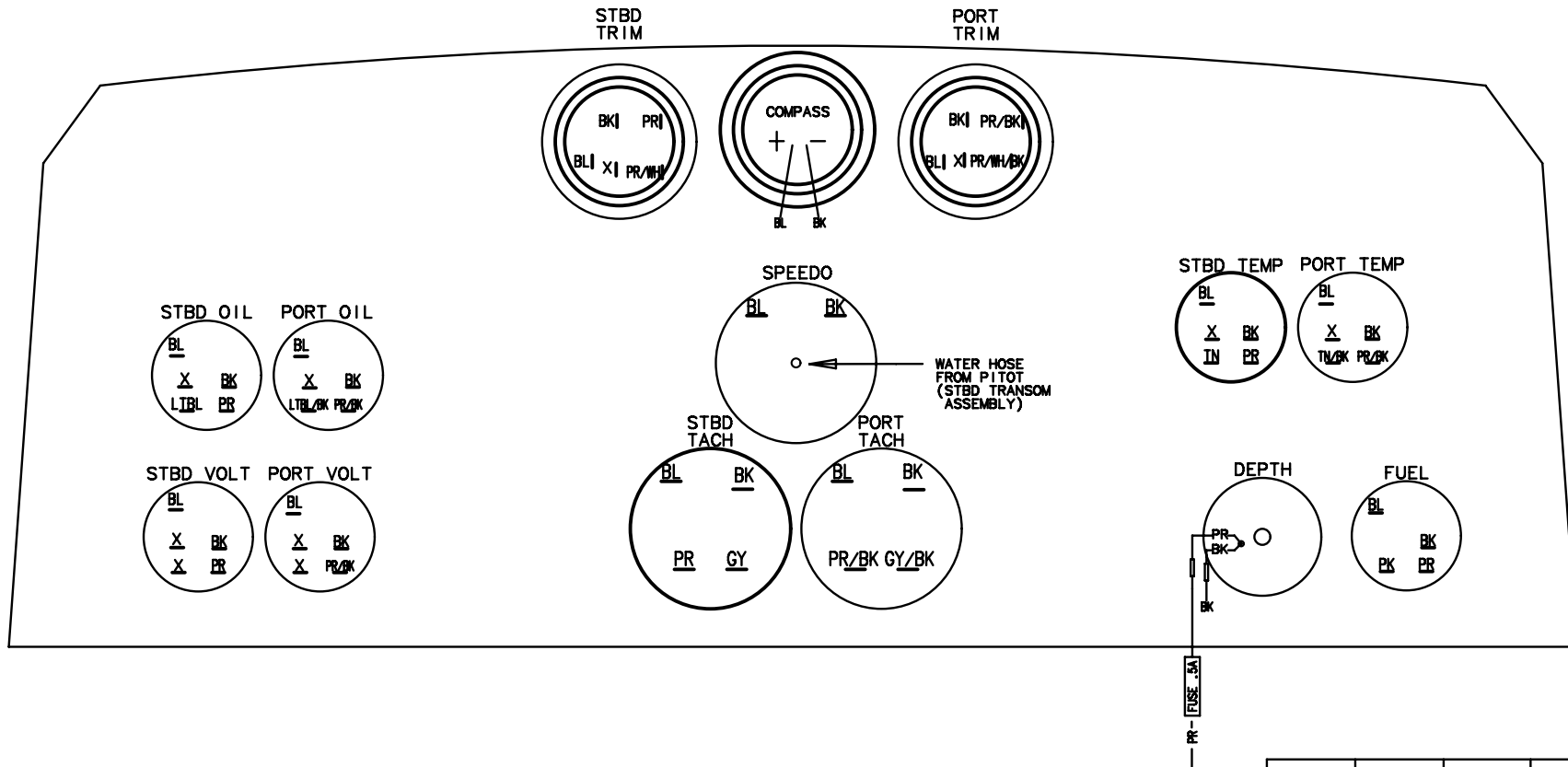

CODE	COLOR	STRIPE	STRIPE
BK	BLACK		
GY	GRAY		
BL	BLUE		
BN	BROWN		
PR	PURPLE		
LTBL	LIGHT BLUE		
TN	TAN		
PK	PINK		
GY	GRAY		
LTBL/BK	LIGHT BLUE	BLACK	
PK/BK	PINK	BLACK	
PR/WH	PURPLE	WHITE	
PR/WH/BK	PURPLE	WHITE	BLACK
TN/BK	TAN	BLACK	
GY/BK	GRAY	BLACK	

MAIN DASH PANEL (REAR VIEW)

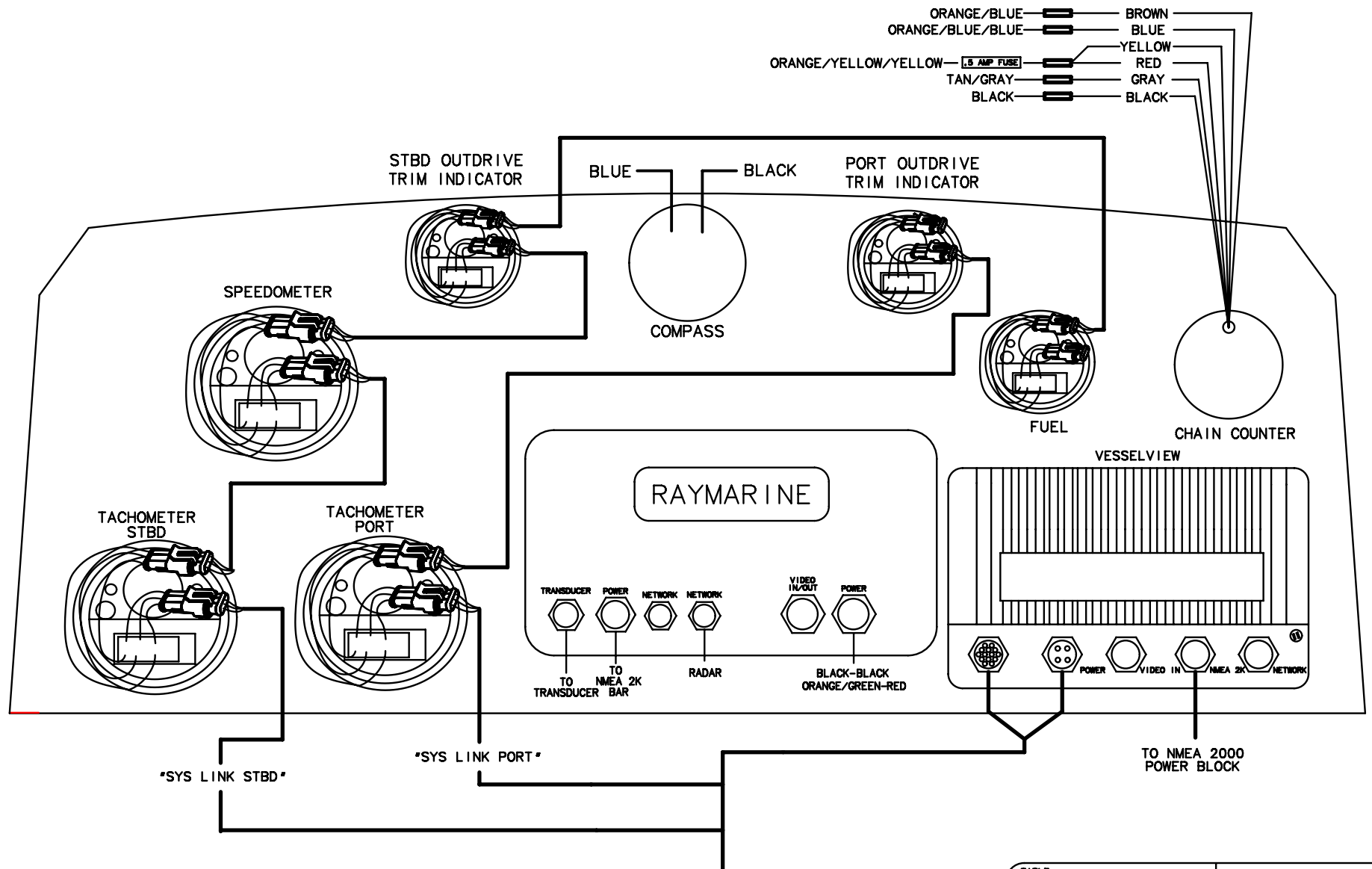

NOTE: ALL PORT AND STBD GAUGES
MUST BE KEPT SEPERATE, WITH
FUEL ON STBD.

TO MERCURY J-BLOCK
(LOCATED BEHIND
MAIN DASH PANEL)

<https://www.boat-manuals.com/>

TITLE: MAIN PANEL W/CHARTPLOTTER AND VESSELVIEW		THUNDERBIRD PRODUCTS
		P.O. BOX 1003
MOD.: 330 CBR	DR BY: KPP	DECATUR IN., 46733
NO.: 80	DATE: 7-1-15	(260) 724-9111

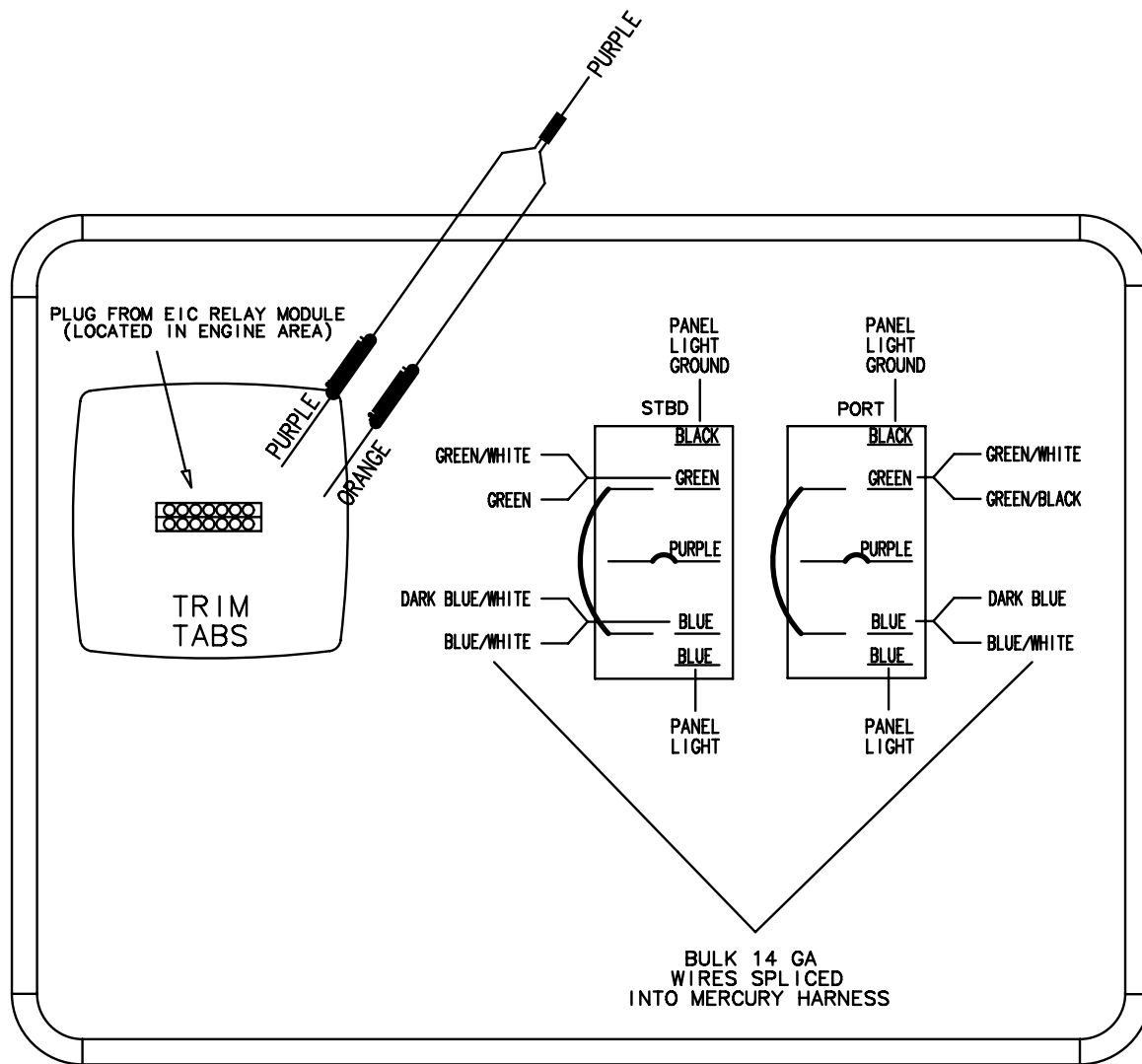

DRIVE TRIM SWITCHES
(REAR VIEW)

DRIVE TRIM SWITCHES ONLY USED
WITH LIVORSI DTS SHIFTER.

TITLE: TRIM PANEL DTS/AXIUS		THUNDERBIRD PRODUCTS
		P.O. BOX 1003
MOD.: 330 CBR	DR BY: KPP	DECATUR IN., 46733
NO.: 81	DATE: 7-1-15	(260) 724-9111

LEGEND

GROUND 

CONNECTOR 

DIODE 

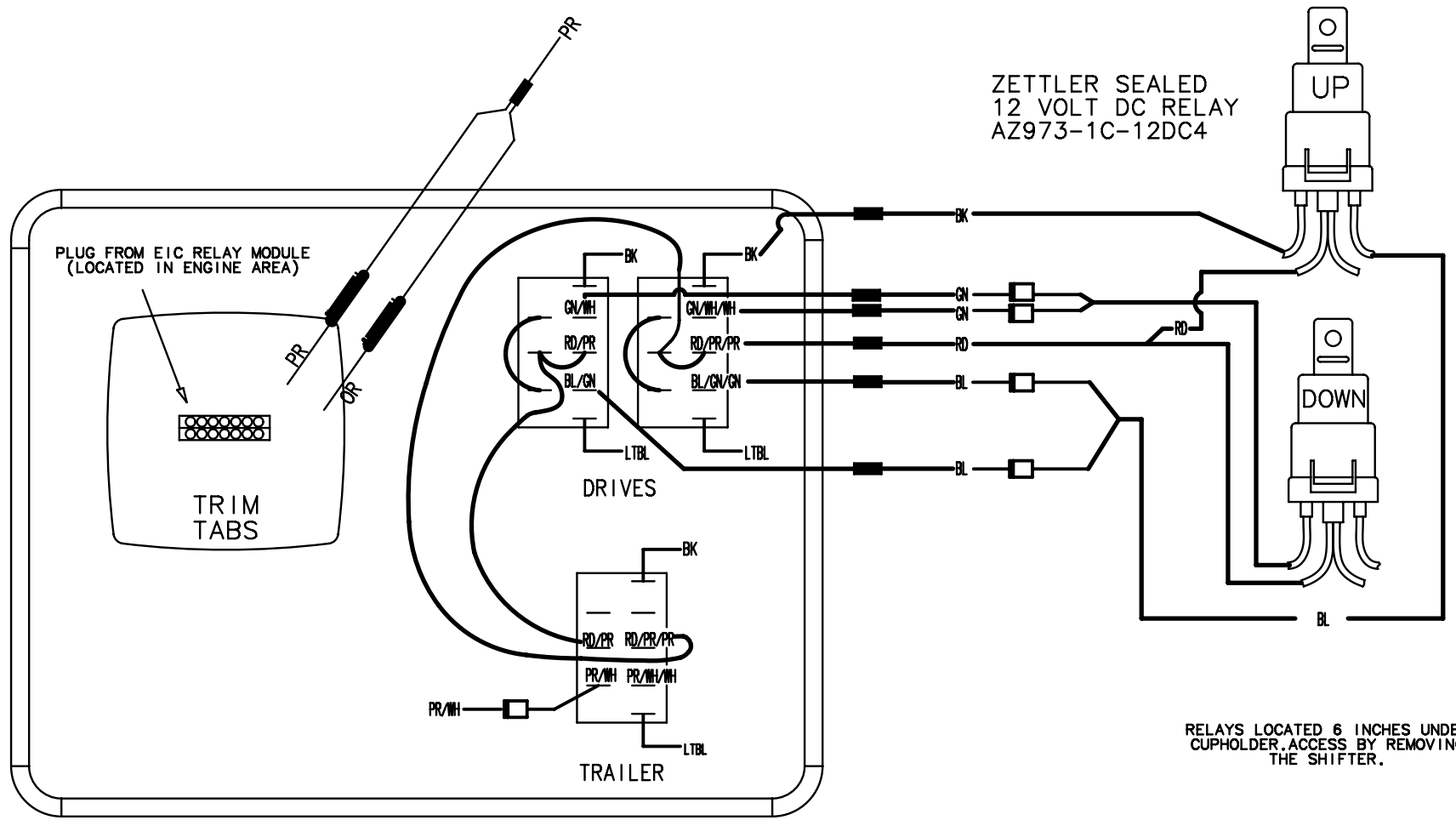

ZETTLER SEALED
12 VOLT DC RELAY
AZ973-1C-12DC4

TRIM PANEL
(REAR VIEW)

RELAYS LOCATED 6 INCHES UNDER
CUPHOLDER. ACCESS BY REMOVING
THE SHIFTER.

TITLE: TRIM PANEL STANDARD		THUNDERBIRD PRODUCTS P.O. BOX 1003
MOD.: 330 CBR	DR BY: KPP	DECATUR IN., 46733
NO.: 82	DATE: 7-1-15	(260) 724-9111

LEGEND

MOTOR/PUMP



BILGE HOSE 1 1/8" - - - -

ANTI
SIPHON
LOOP

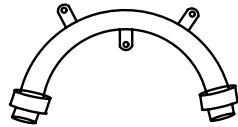

BILGE PUMP
(ENGINE AREA)

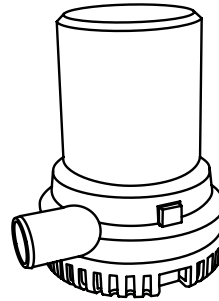

BILGE PUMP
(LAZARETTE)

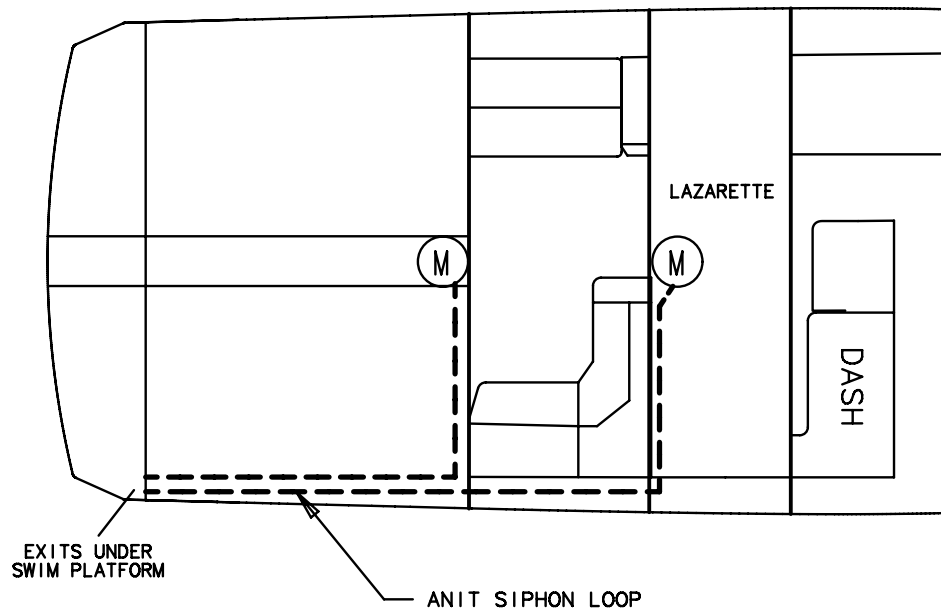
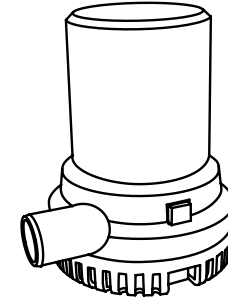

TITLE: BILGE PUMP PLUMBING		THUNDERBIRD PRODUCTS
		P.O. BOX 1003
MOD.: 330 CBR	DR BY: KPP	DECATUR IN., 46733
NO.: 83	DATE: 7-1-15	(260) 724-9111

LEGEND

STANDARD HOSE ———

GRAY WATER OPTION - - -

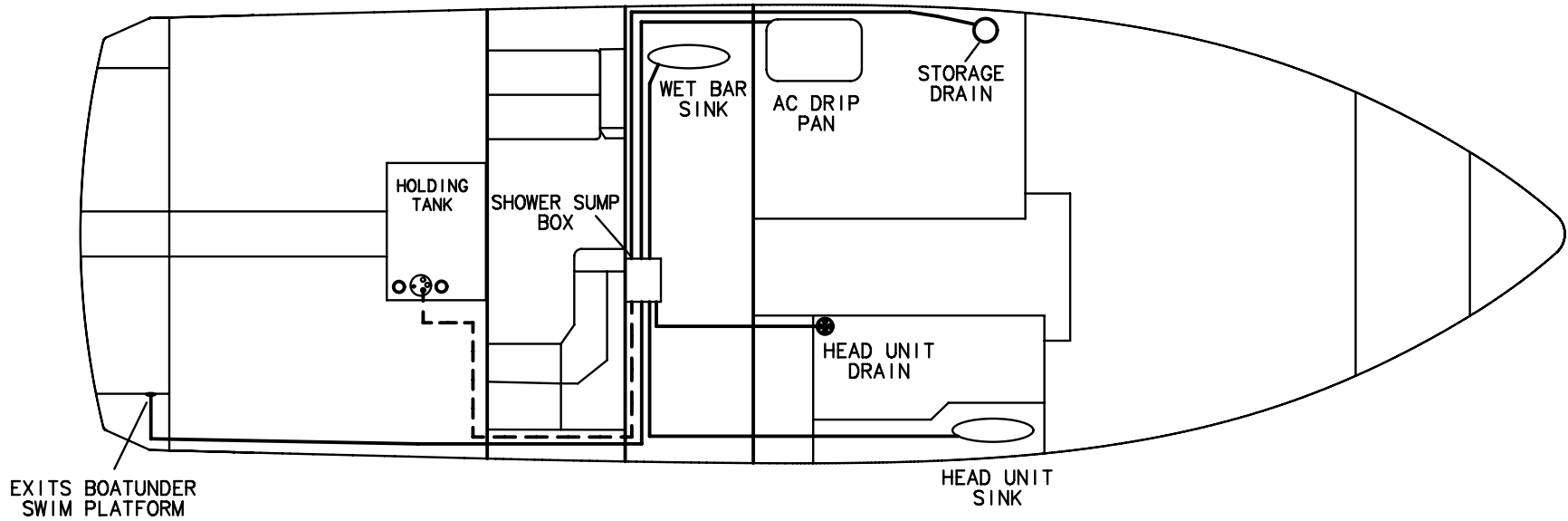

TITLE: SHOWER SUMP PLUMBING		THUNDERBIRD PRODUCTS
		P.O. BOX 1003
MOD.: 330 CBR	DR BY: KPP	DECATUR IN., 46733
NO.: 84	DATE: 7-1-15	(260) 724-9111

LEGEND

1 1/4 INCH
SANITATION HOSE



FLOAT SWITCH

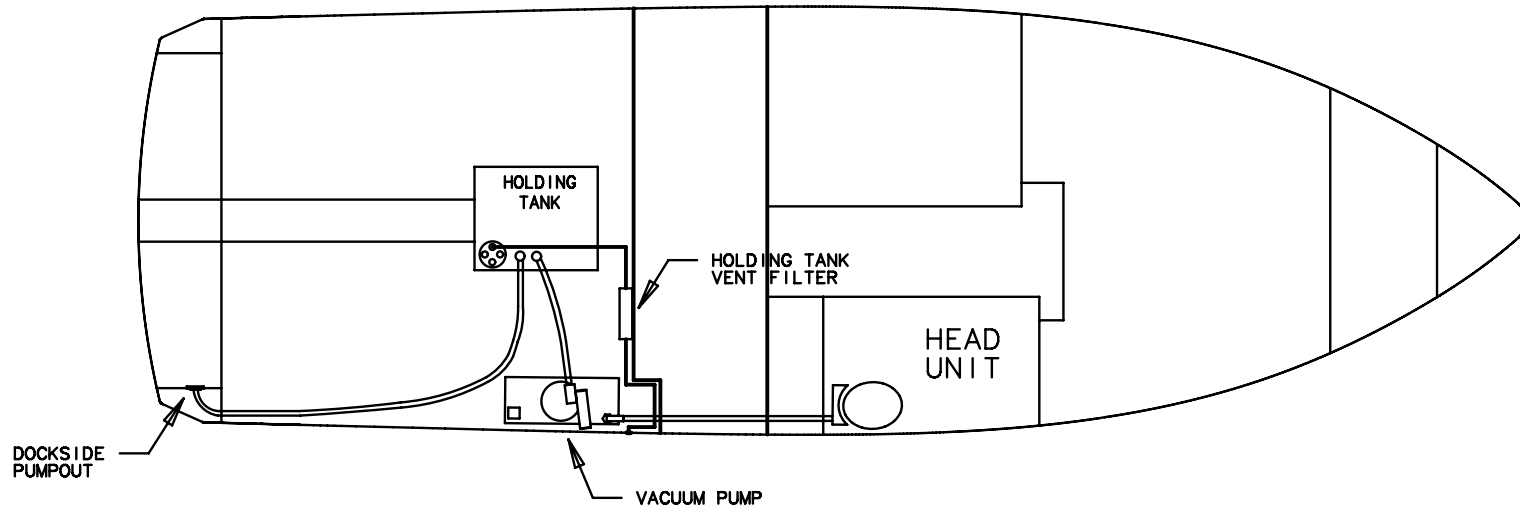

TITLE: WASTE SYSTEM (PLUMBING)		THUNDERBIRD PRODUCTS
		P.O. BOX 1003
MOD.: 330 CBR	DR BY: KPP	DECATUR IN., 46733
NO.: 85	DATE: 7-1-15	(260) 724-9111

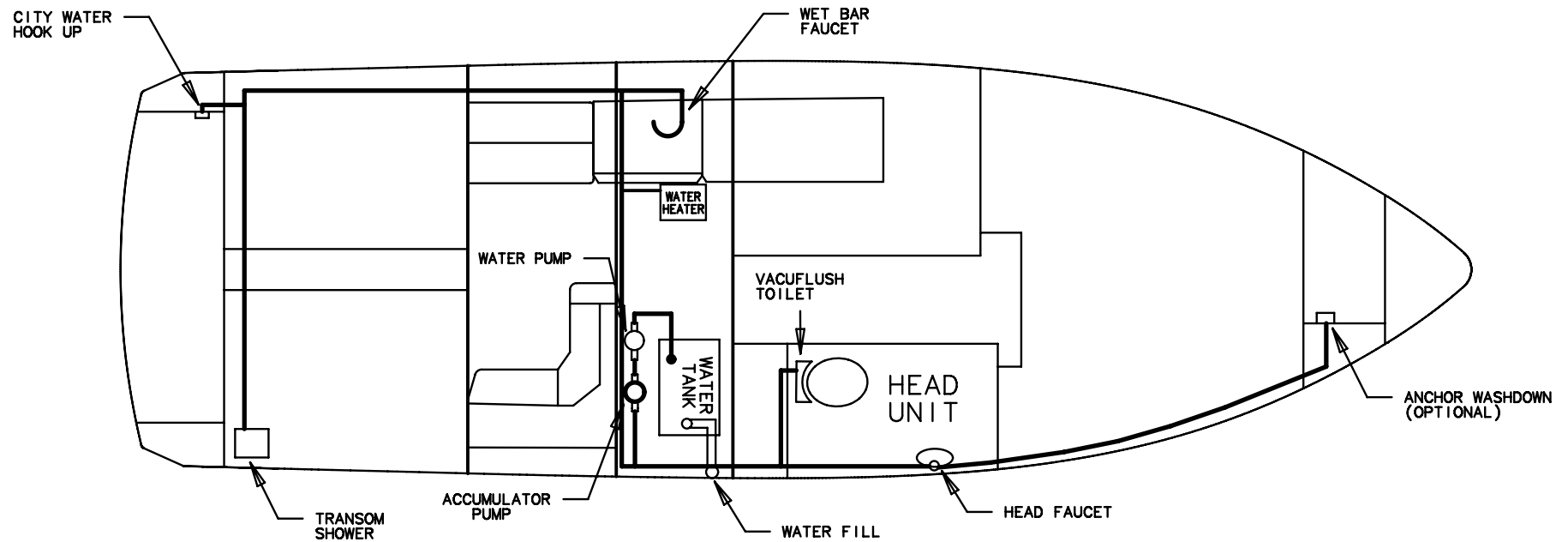

TITLE: WATER SYSTEM PLUMBING		THUNDERBIRD PRODUCTS
		P.O. BOX 1003
MOD.: 330 CBR	DR BY: KPP	DECATUR IN., 46733
NO.: 86	DATE: 7-1-15	(260) 724-9111

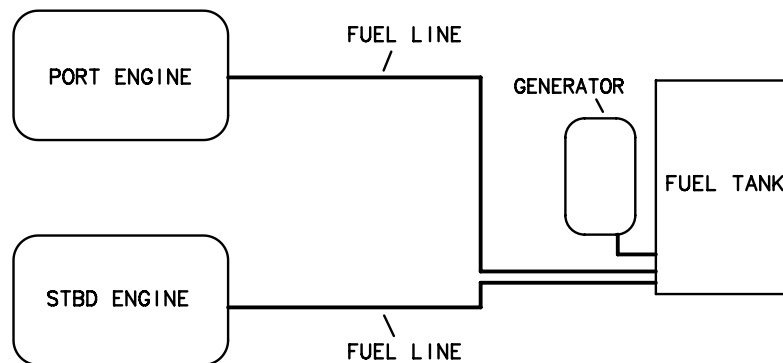
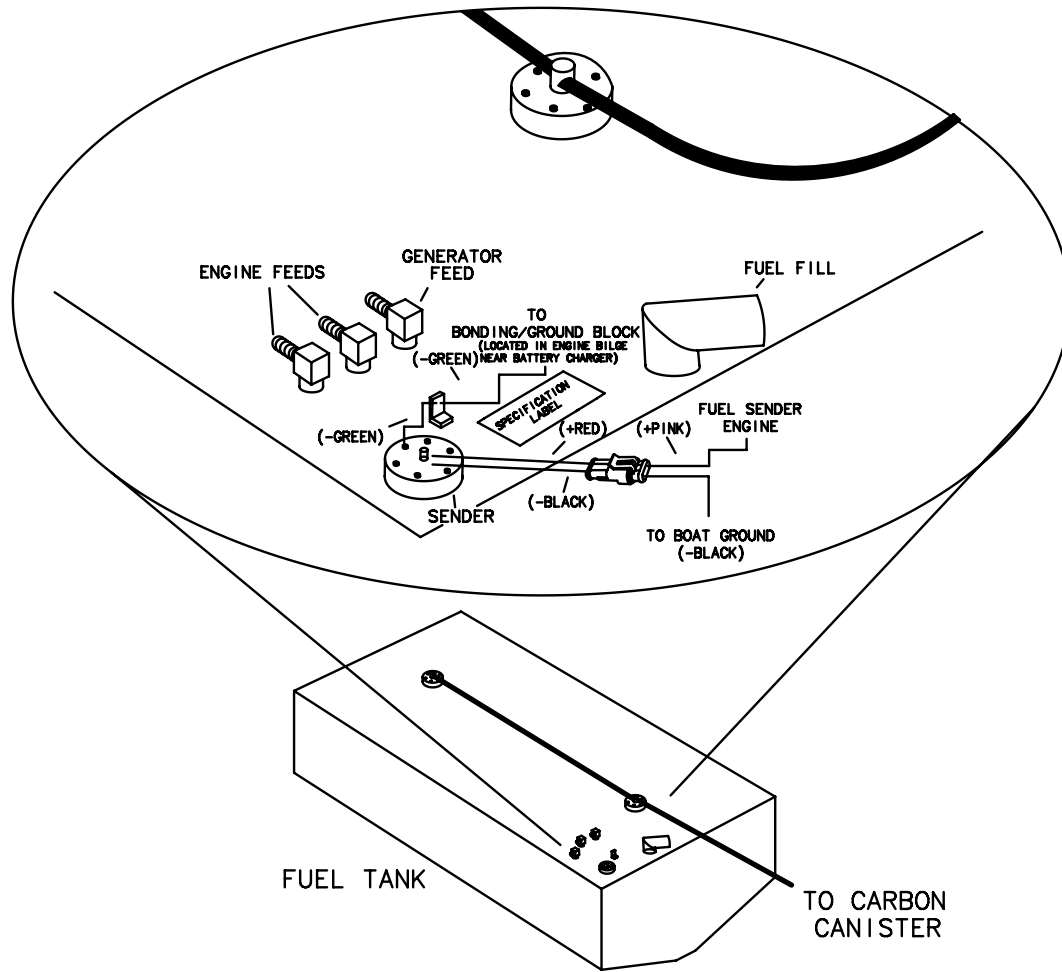

TITLE: FUEL TANK		THUNDERBIRD PRODUCTS
		P.O. BOX 1003
MOD.: 330 CBR	DR BY: KPP	DECATUR IN., 46733
NO.: 87	DATE: 7-1-15	(260) 724-9111

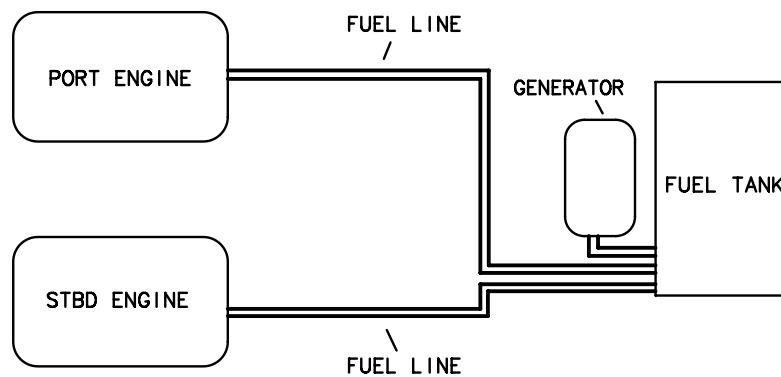
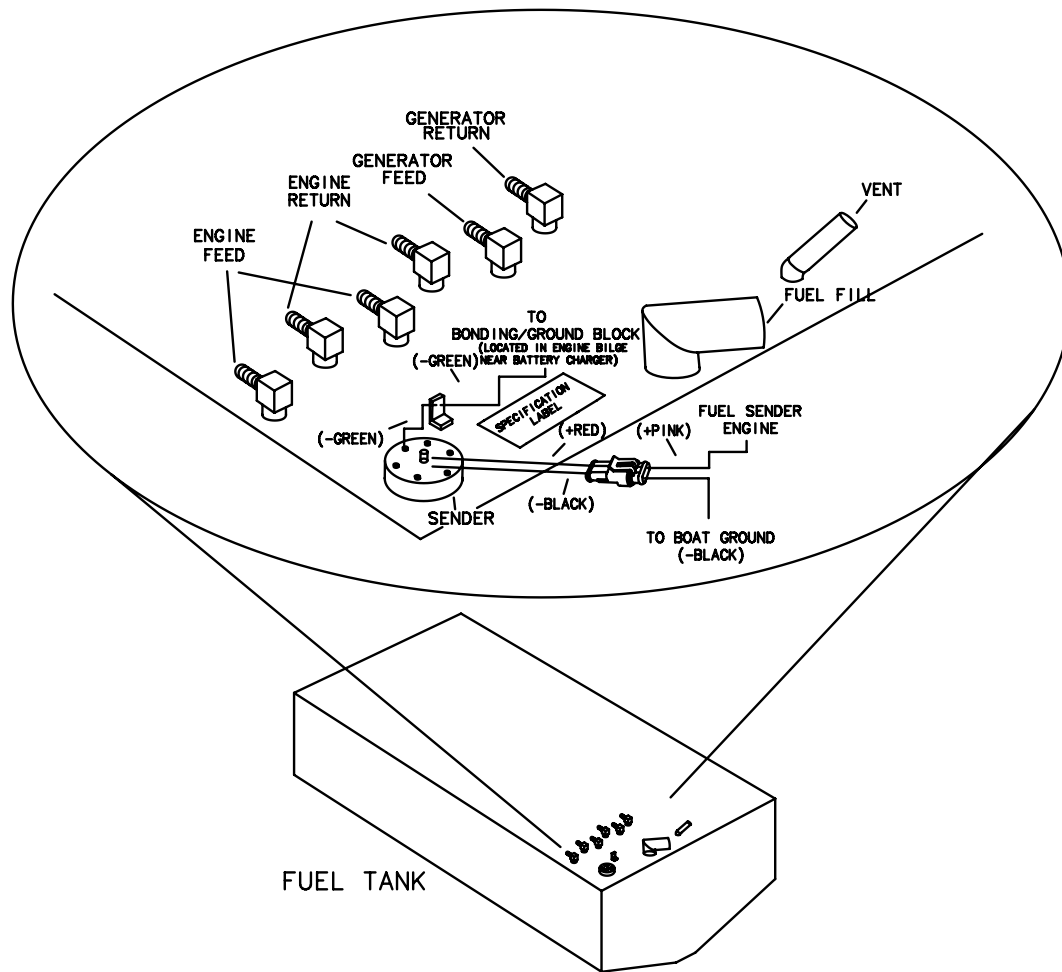

TITLE: FUEL TANK (DIESEL)		THUNDERBIRD PRODUCTS
		P.O. BOX 1003
MOD.: 330 CBR	DR BY: KPP	DECATUR IN., 46733
NO.: 88	DATE: 7-1-15	(260) 724-9111