

# THUNDERBIRD PRODUCTS

#49238

FIRST EDITION 2007

Because of the Formula commitment to product quality and innovation, we reserve the right, at any time, to discontinue or change specifications, design, or features without incurring obligation. Thunderbird Products is not responsible for any technical issues that may arise due to the use of obsolete drawings.

<https://www.boat-manuals.com/>

# CONTENTS

TABLE OF CONTENTS . . . . .	1	FUME DETECTOR . . . . .	35
TABLE OF CONTENTS . . . . .	2	GPS . . . . .	45
HARNESSES AND PIGTAIL #'S . . . . .	3	HEAD BLOWER . . . . .	36
WIRING HARNESS LAYOUT . . . . .	4	HELM VIEW . . . . .	38
WIRING HARNESS LAYOUT . . . . .	5	HIGH WATER ALARM . . . . .	39
<b><u>AC CIRCUITS</u></b>		HORN . . . . .	40
120v AC SYSTEM PANEL . . . . .	16	IGNITION PANEL . . . . .	9
AC OUTLETS . . . . .	17	IGNITION SYSTEM . . . . .	41
BATTERY CHARGER (AC CURRENT) . . . . .	18	LIGHTS	
COCKPIT REFRIGERATOR . . . . .	19	ANCHOR LIGHTS. . . . .	22
WATER HEATER . . . . .	20	CABINET LIGHT . . . . .	25
<b><u>DC CIRCUITS</u></b>		COURTESY LIGHTS . . . . .	29
12v DC SYSTEM PANEL . . . . .	15	DOCKING LIGHTS . . . . .	32
AFT BREAKER PANEL . . . . .	7	HEAD LIGHT . . . . .	37
BATTERY PARALLEL / BATT. CHGR . . . . .	21	NAVIGATION LIGHTS. . . . .	44
BILGE BLOWERS . . . . .	22	SPOTLIGHT . . . . .	49
CABIN BILGE PUMP . . . . .	23	MACERATOR . . . . .	42
ENGINE BILGE PUMP . . . . .	24	MERCATHODE . . . . .	43
CAPTAIN'S CALL (PORT) . . . . .	26	NAVIGATION SYSTEM . . . . .	45
CAPTAIN'S CALL (STBD) . . . . .	27	OUTDRIVE PUMP . . . . .	46
CO DETECTOR . . . . .	28	SEAKEY . . . . .	47
DASH BREAKER PANEL . . . . .	8	SHOWER SUMP . . . . .	48
DASH OUTLET . . . . .	30	STARTER SOLENOID . . . . .	50
DEPTH SOUNDER . . . . .	31	STEREO . . . . .	51
ENGINE HATCH . . . . .	33	STEREO SYSTEM . . . . .	52
FIRE EXTINGUISHER . . . . .	34	TRIM TAB PUMP . . . . .	53
		VHF RADIO . . . . .	54
		WASTE SYSTEM . . . . .	55
		WATER PUMP . . . . .	56
		WINDLASS . . . . .	57

# **CONTENTS**

## **DC CIRCUITS**

WIPER . . . . . 58

## **PANELS**

ACCESSORY PANEL . . . . . 6

AFT BREAKER PANEL . . . . . 7

BATTERY SWITCH PANEL . . . . . 21

DASH BREAKER PANEL . . . . . 8

IGNITION PANEL . . . . . 9

INSTRUMENT PANEL (BASE/GPS) . . . . . 10

INSTRUMENT PANEL (CHART) . . . . . 11

INSTRUMENT PANEL (DTS) . . . . . 12

TRIM TAB PANEL . . . . . 13

TRIM TAB PANEL (DTS) . . . . . 14

12v DC SYSTEM PANEL . . . . . 15

120v AC SYSTEM PANEL . . . . . 16

## **PLUMBING**

HEAD PUMP . . . . . 59

MACERATOR . . . . . 59

SHOWER SUMP . . . . . 60

WATER SYSTEM DIAGRAM . . . . . 61

## **FUEL SYSTEM**

FUEL SYSTEM . . . . . 62

# HARNESS & PIGTAIL #'S

## HARNESSES

DECK .....	45993
HULL .....	45994
110V AC .....	46995
220V AC .....	46996

## PIGTAILS

ACCESSORY PANEL .....	47323
AC/DC PANEL .....	45037
AFT BREAKER PANEL .....	43891
ARCH .....	43880
DASH BREAKER PANEL .....	43883
ENGINE HATCH .....	43867
HEAD UNIT .....	45038
HELM SEAT .....	47327
IGNITION PANEL .....	44708
MAIN INSTRUMENT PANEL .....	43882
TRIM TAB .....	43892
WINDLASS .....	47332

## LEGEND

WIRE IDENTIFICATION			
WIRE COLOR	STRIPE	STRIPE	ABBREVIATION
YELLOW	BROWN	RED	YL/BN/RD

WIRE COLOR SYMBOLS	
RED	RD
ORANGE	OR
YELLOW	YL
GREEN	GN
BLUE	BL
LIGHT BLUE	LT BL
PURPLE	PR
PINK	PK
BROWN	BN
BLACK	BK
WHITE	WH

# 310 WIRING HARNESS LAYOUT

LEGEND	
DECK HARNESS	—
HULL HARNESS	—
HARNESS PLUG	□

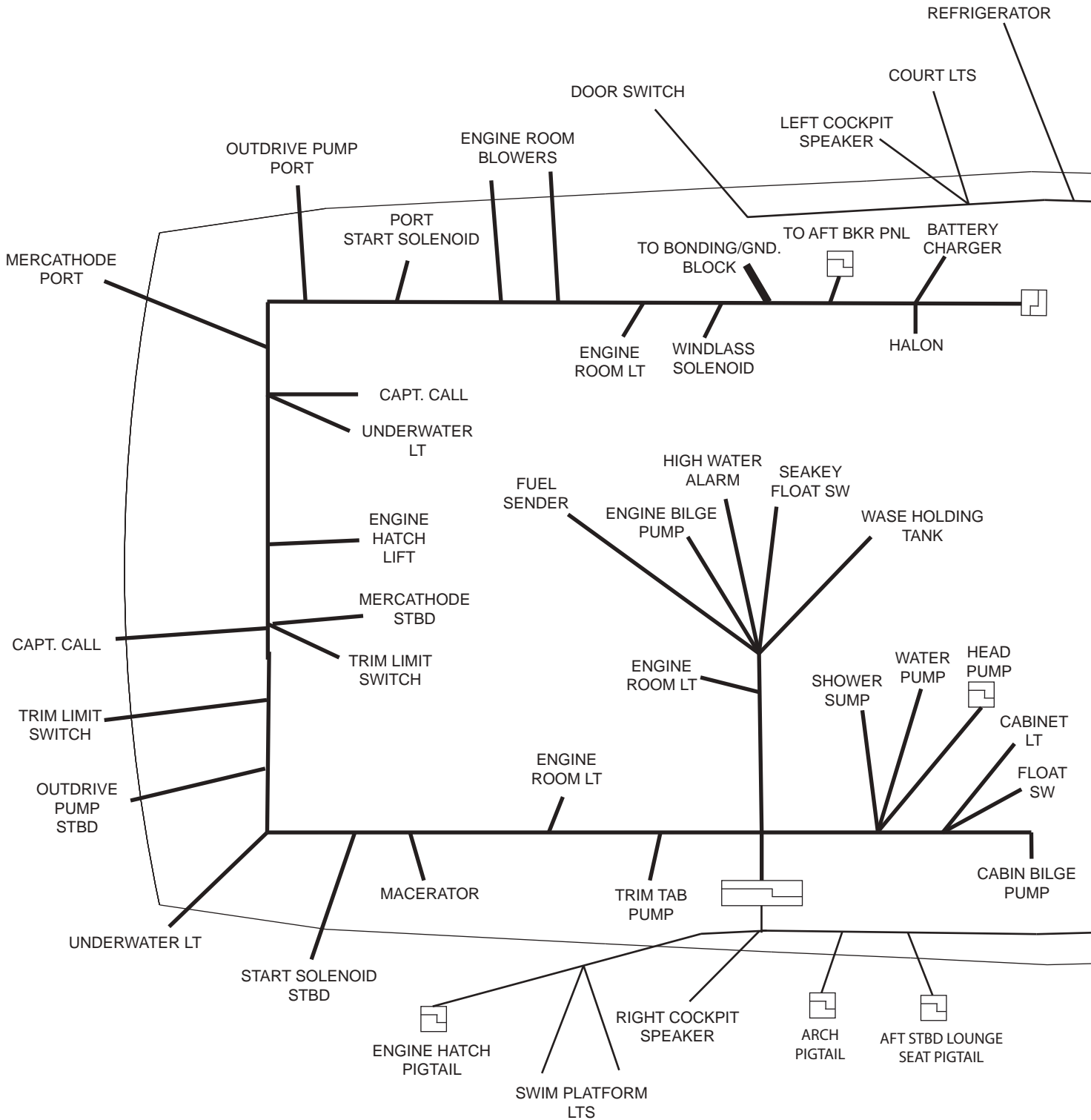

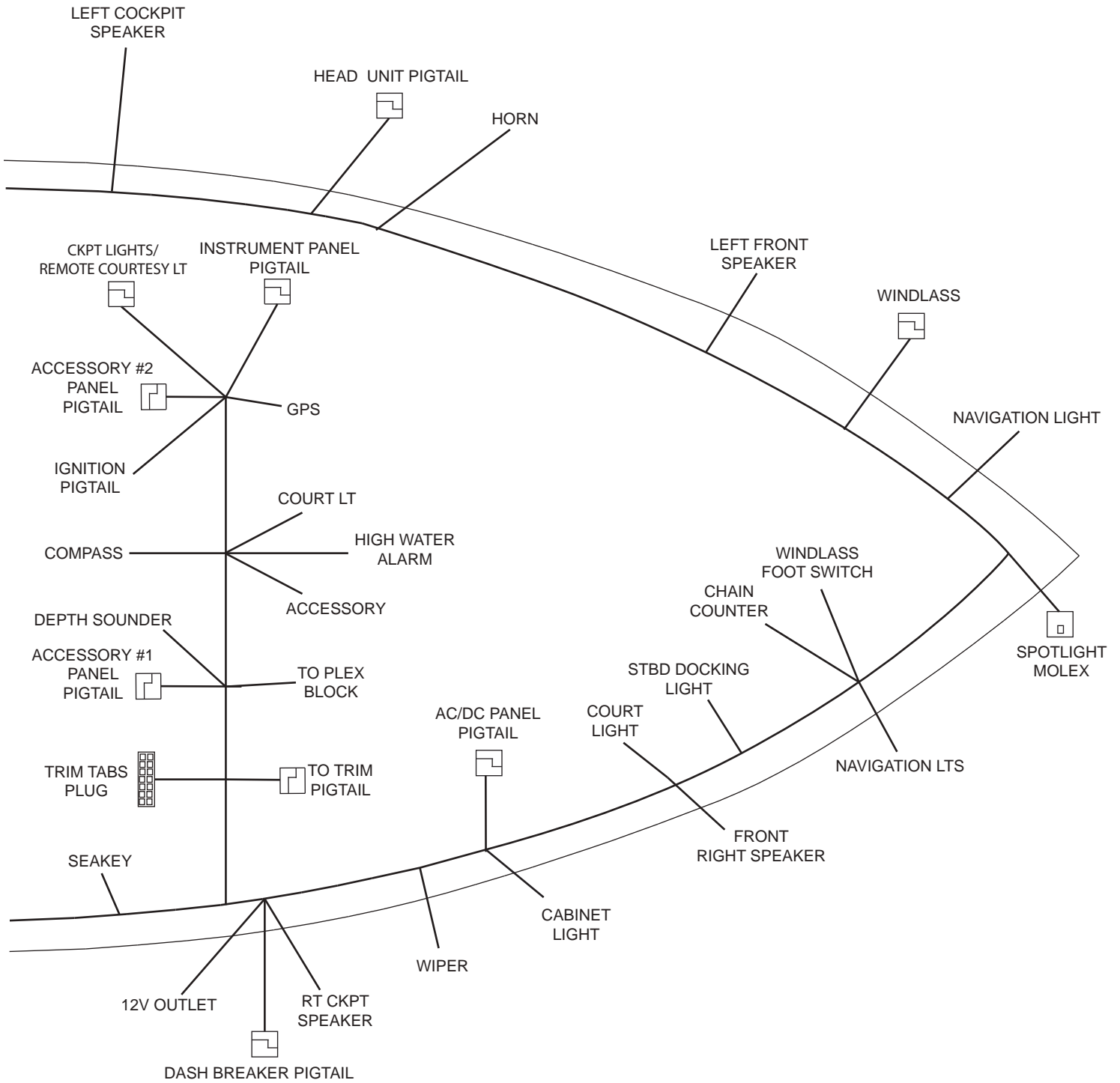



# AFT BREAKER PANEL

(REAR VIEW)

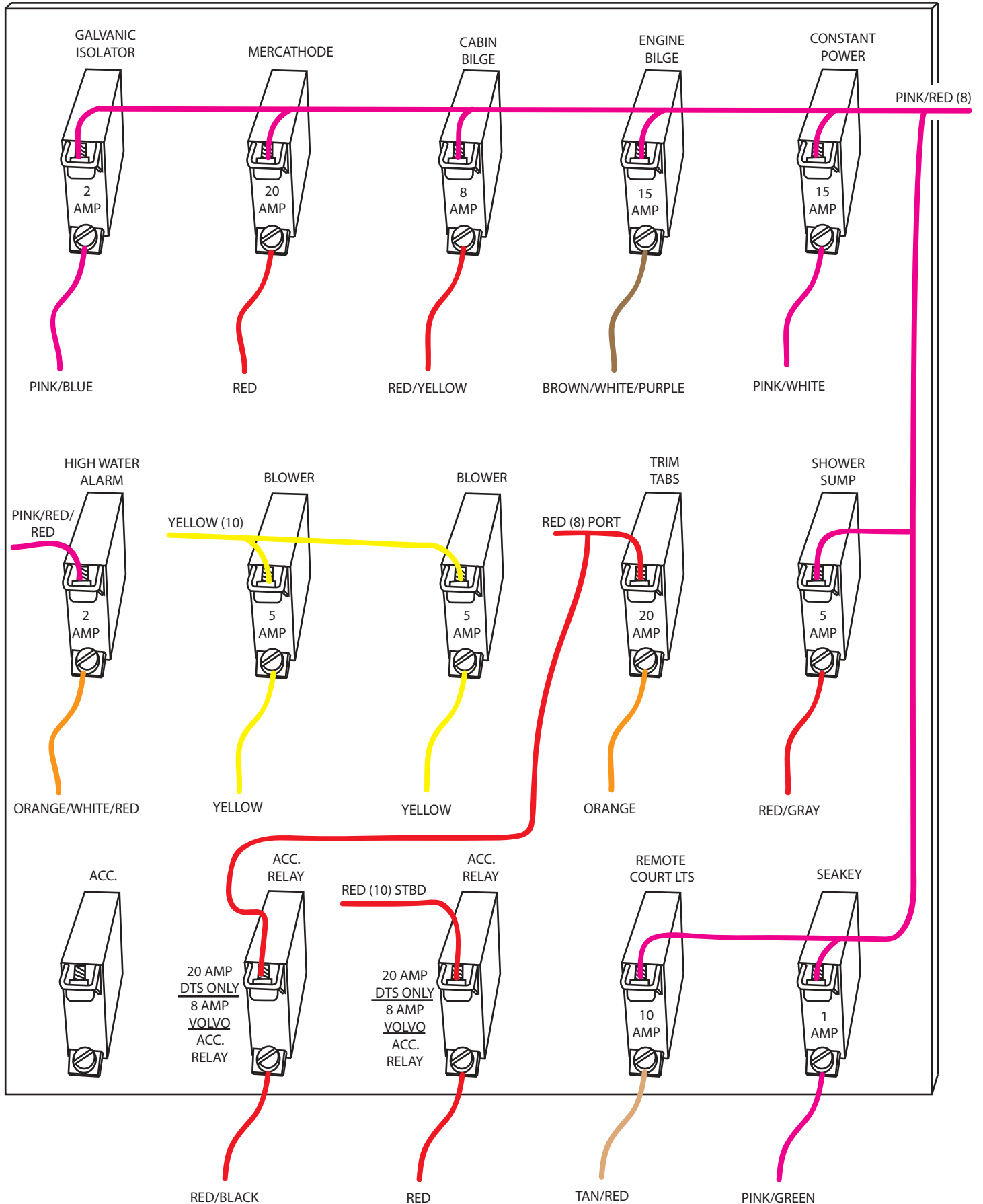



# DASH BREAKER PANEL

(REAR VIEW)

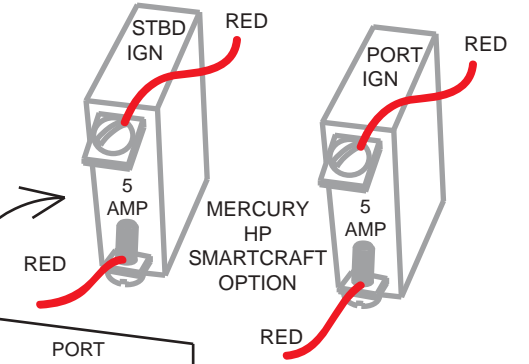
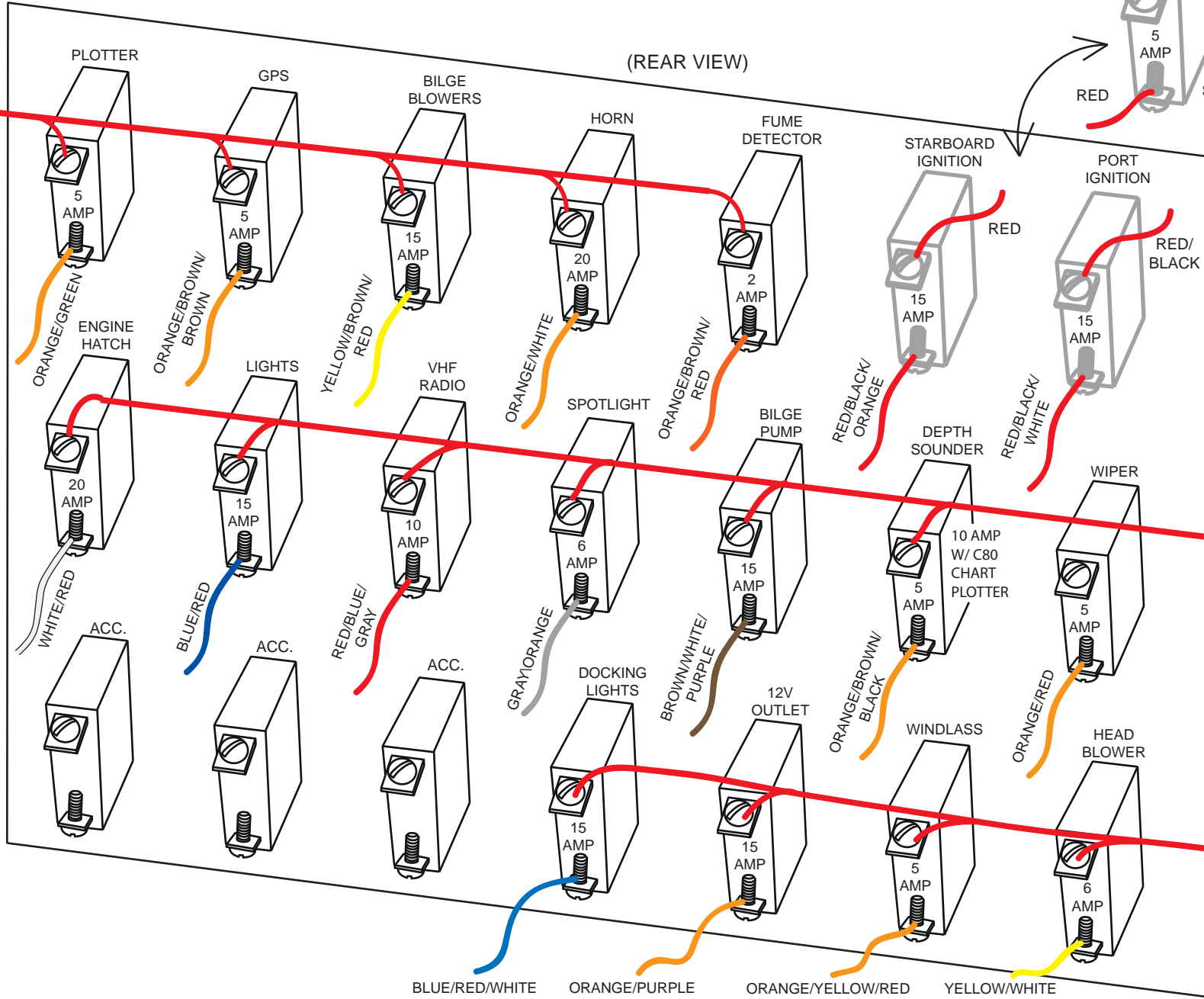

# IGNITION PANEL

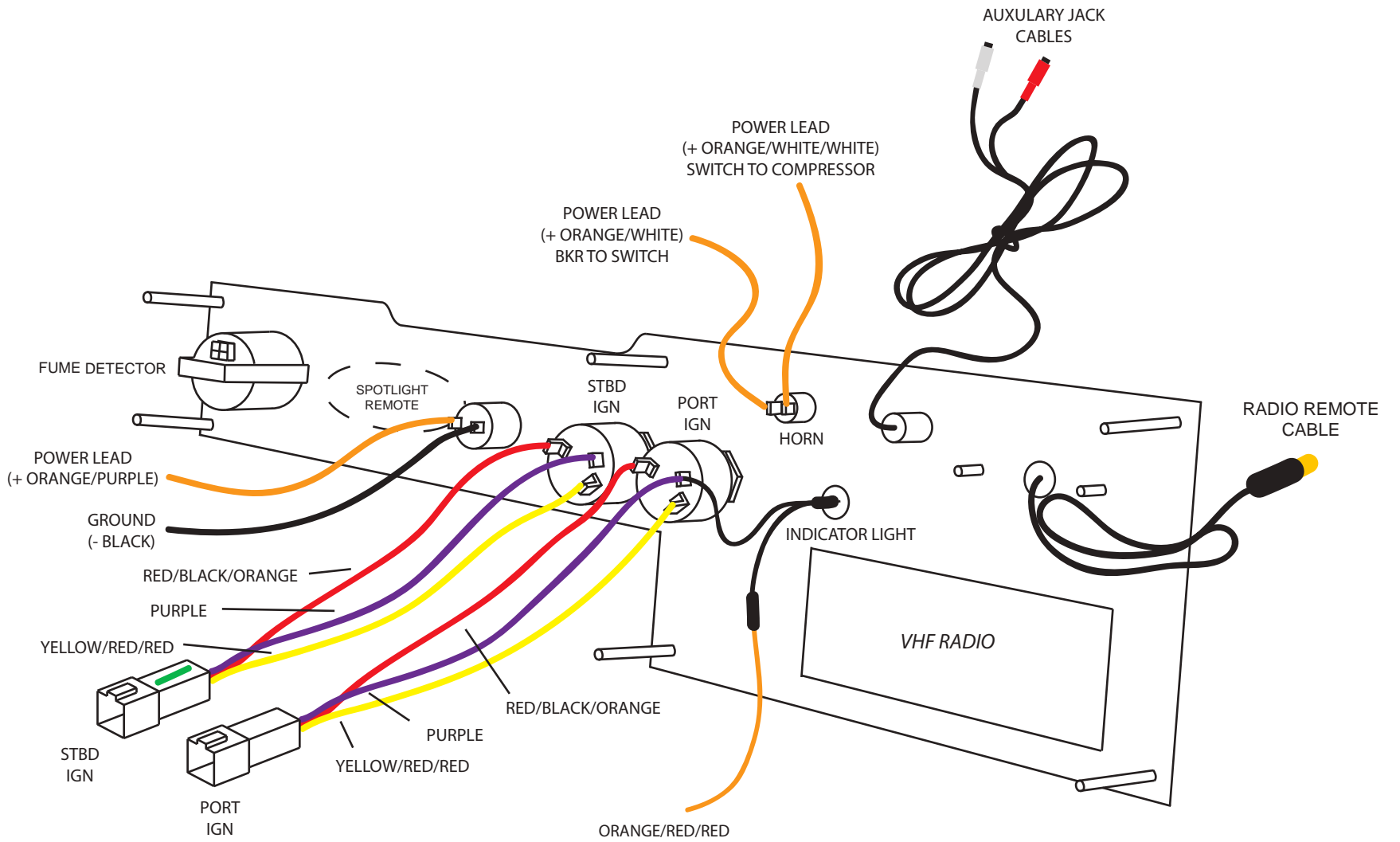

9

310BR

# INSTRUMENT PANEL

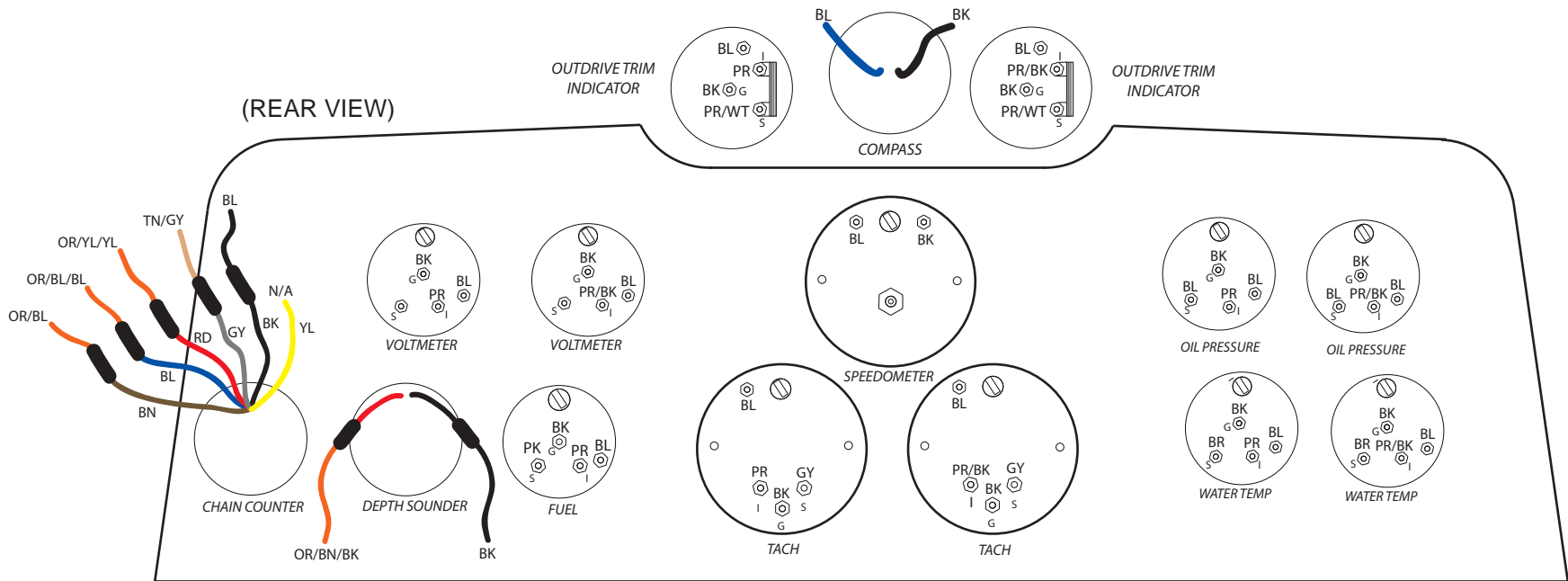

(GAUGES)

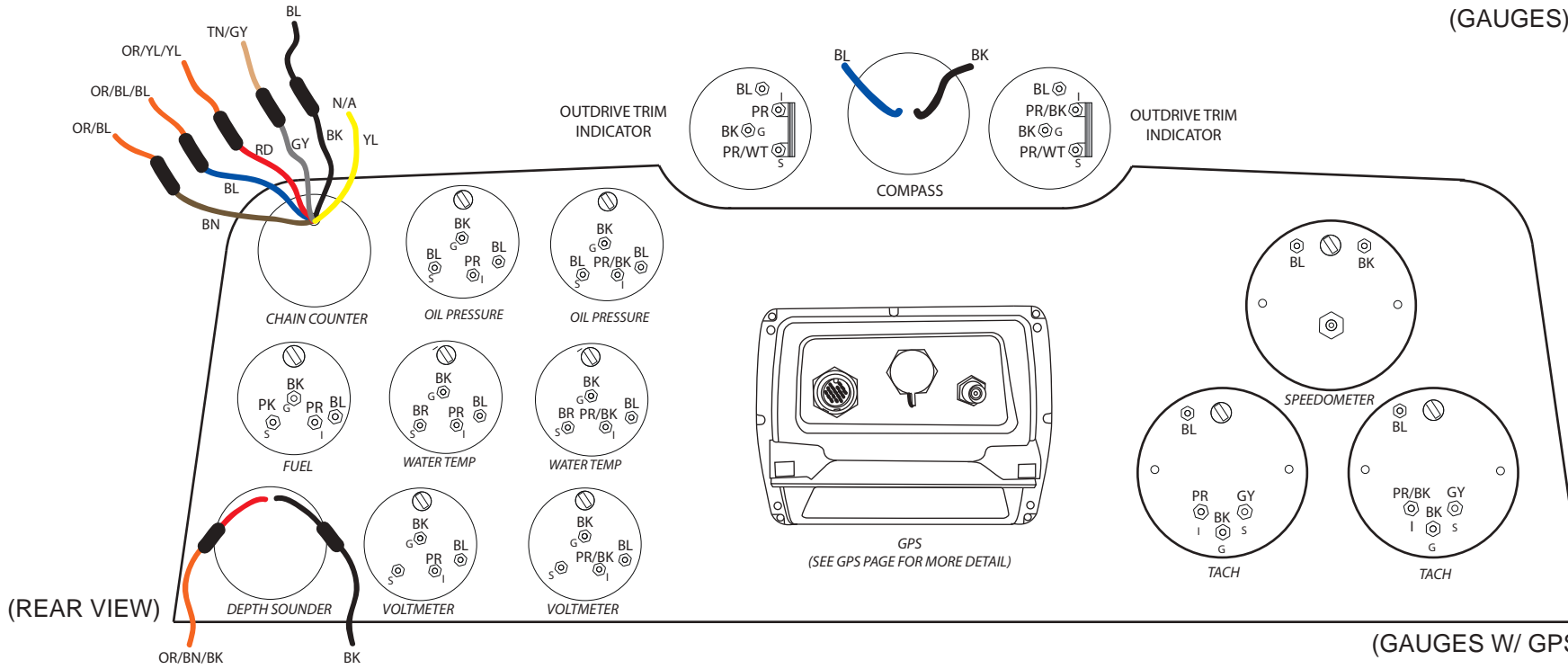

(GAUGES W/ GPS)

# INSTRUMENT PANEL

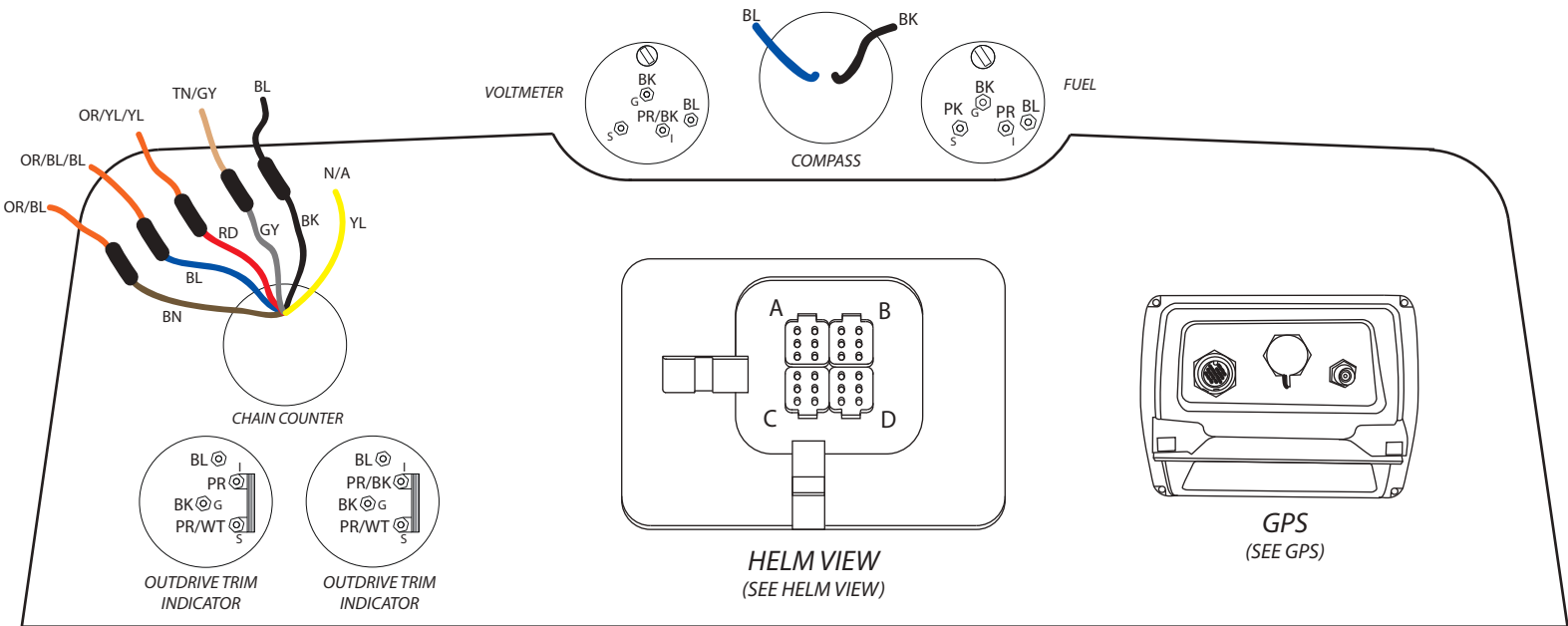

(REAR VIEW)

(HELM VIEW OPTION)

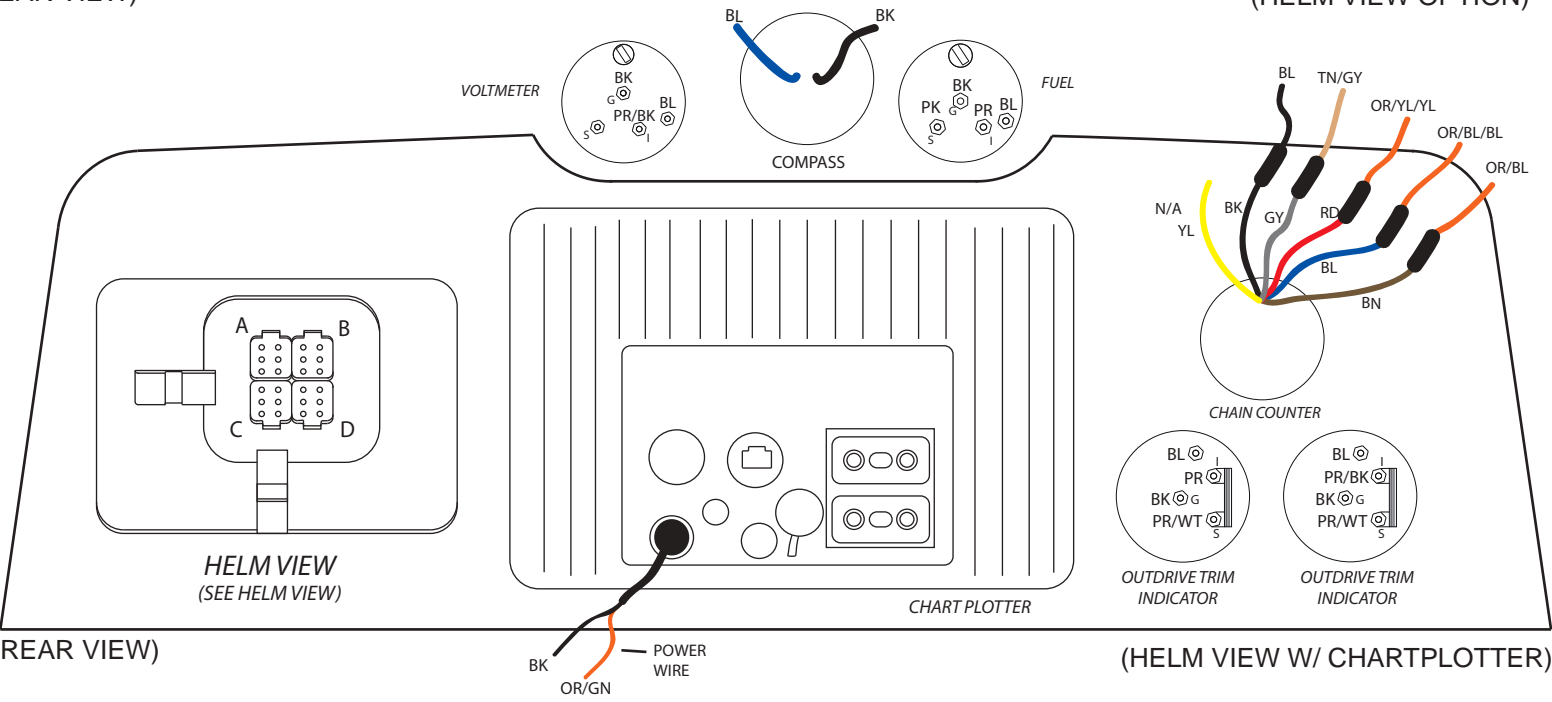

(REAR VIEW)

(HELM VIEW W/ CHARTPLOTTER)

# INSTRUMENT PANEL

(DTS SMARTCRAFT W/ CHARTPLOTTER)

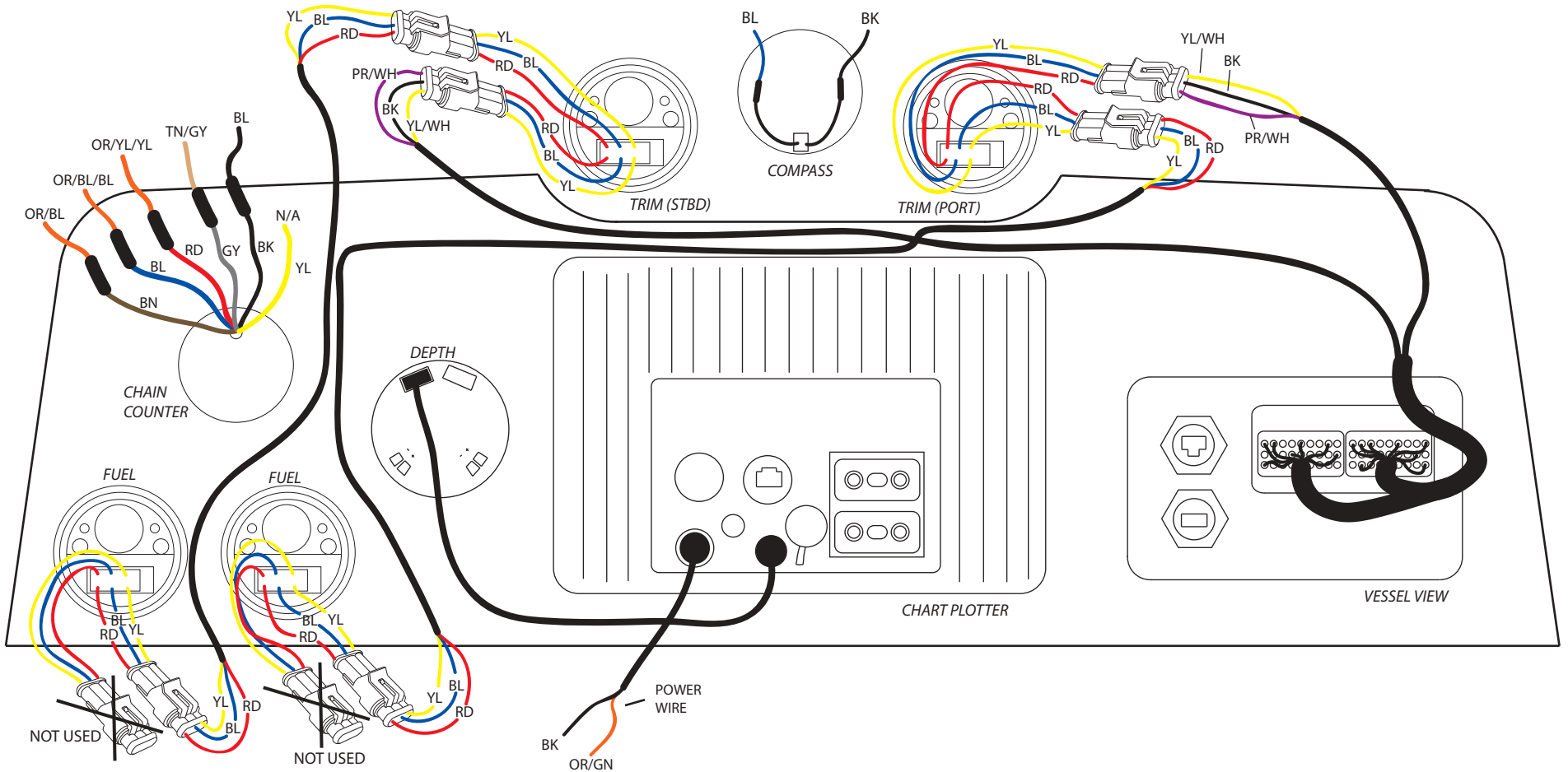

(REAR VIEW)

# TRIM TAB PANEL

## (STANDARD TRIM PANEL)

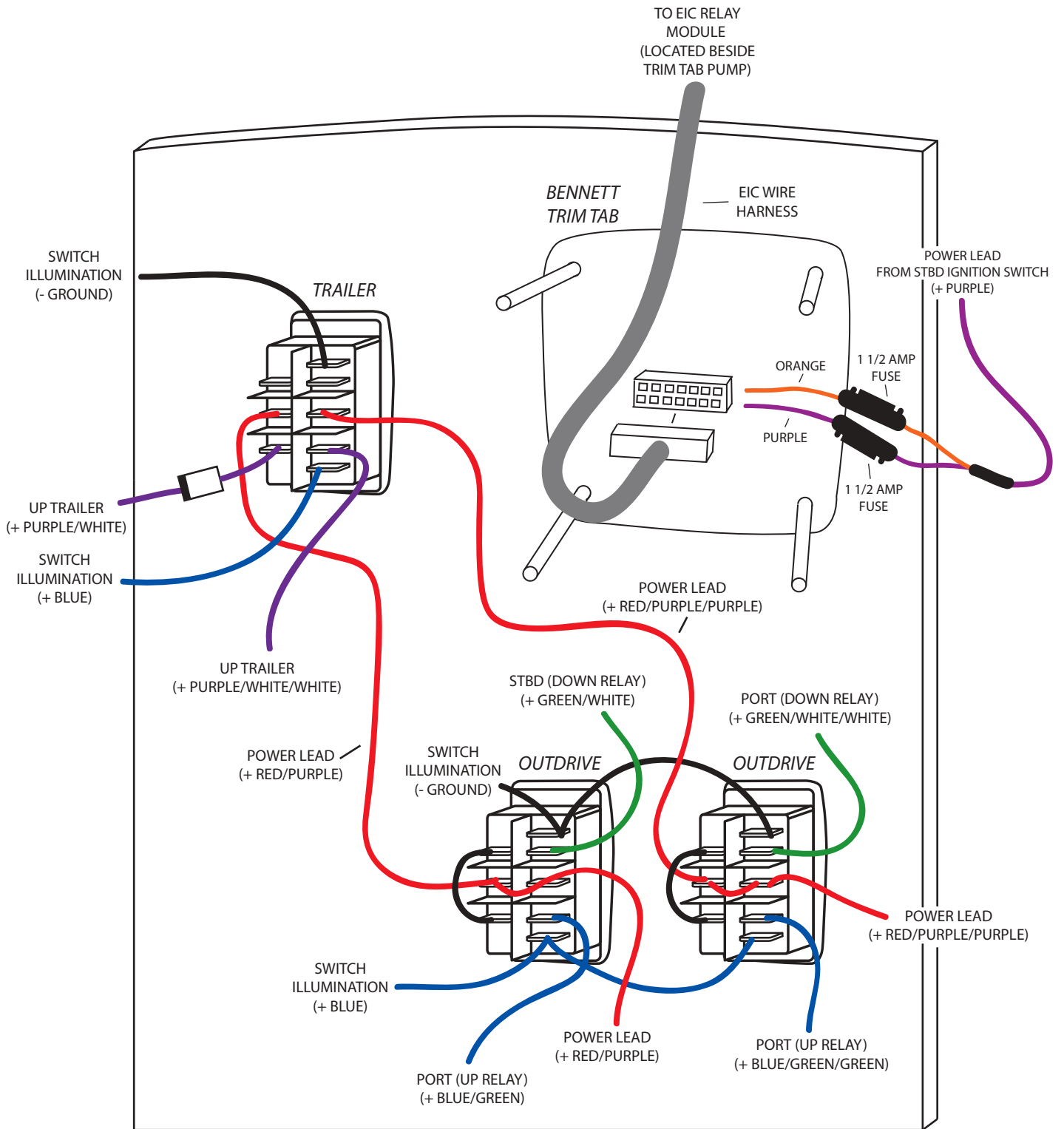

SEE OUTDRIVE PUMP FOR MORE DETAIL

# TRIM TAB PANEL

## (DTS TRIM PANEL)

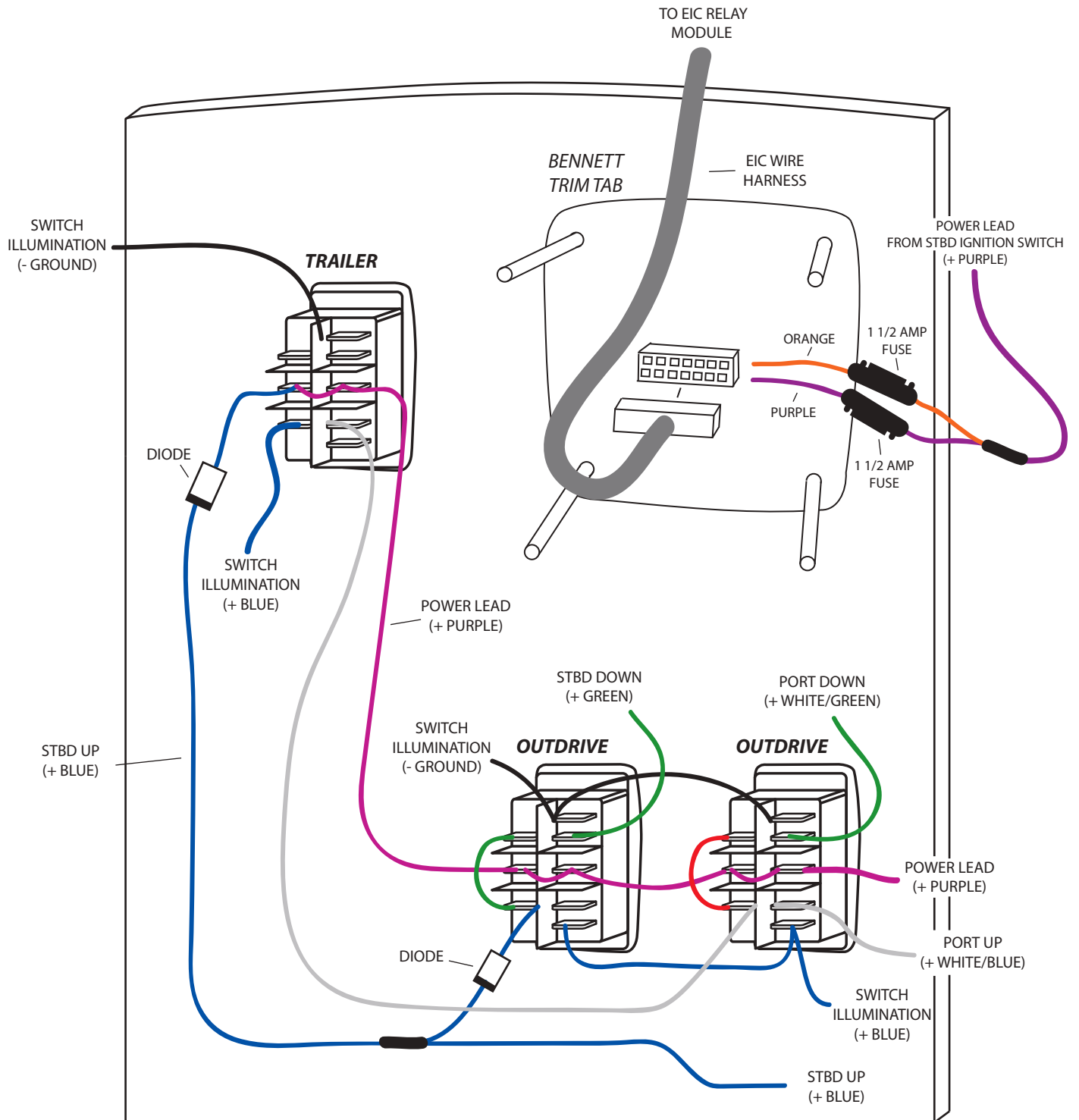

# 12 VOLT DC SYSTEM PANEL

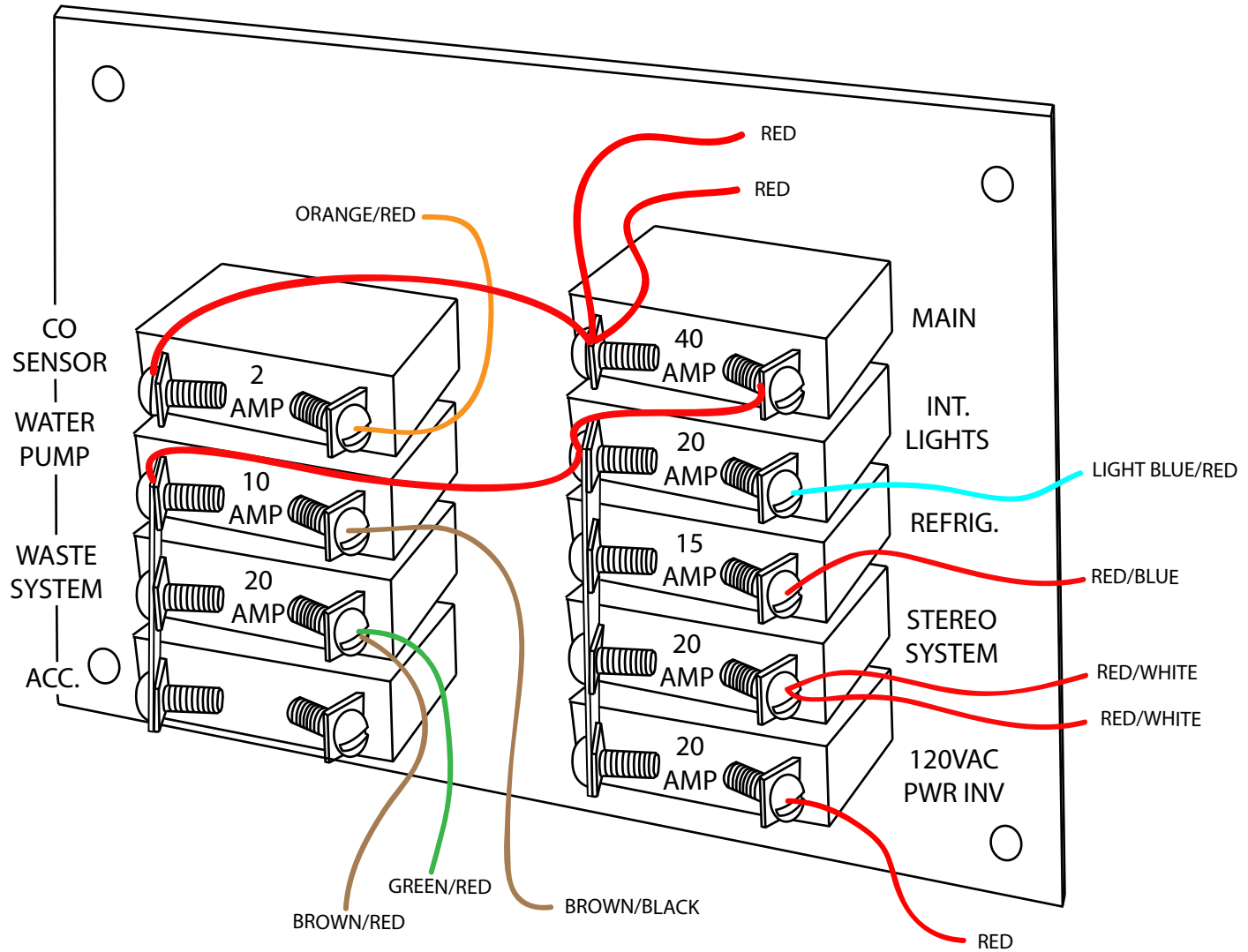

15

310BR



# 120V 60HZ AC SYSTEM PANEL

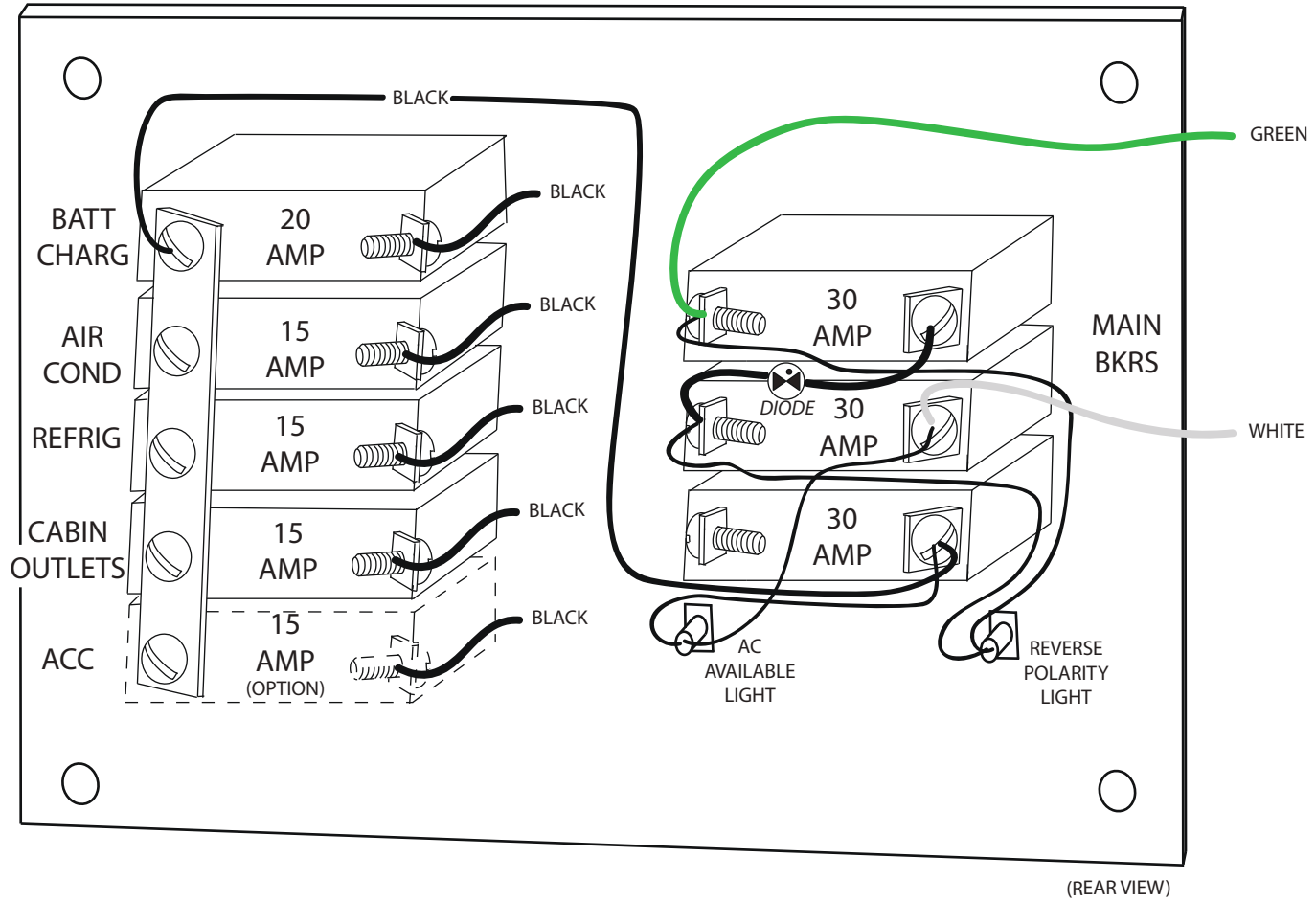

# AC OUTLETS

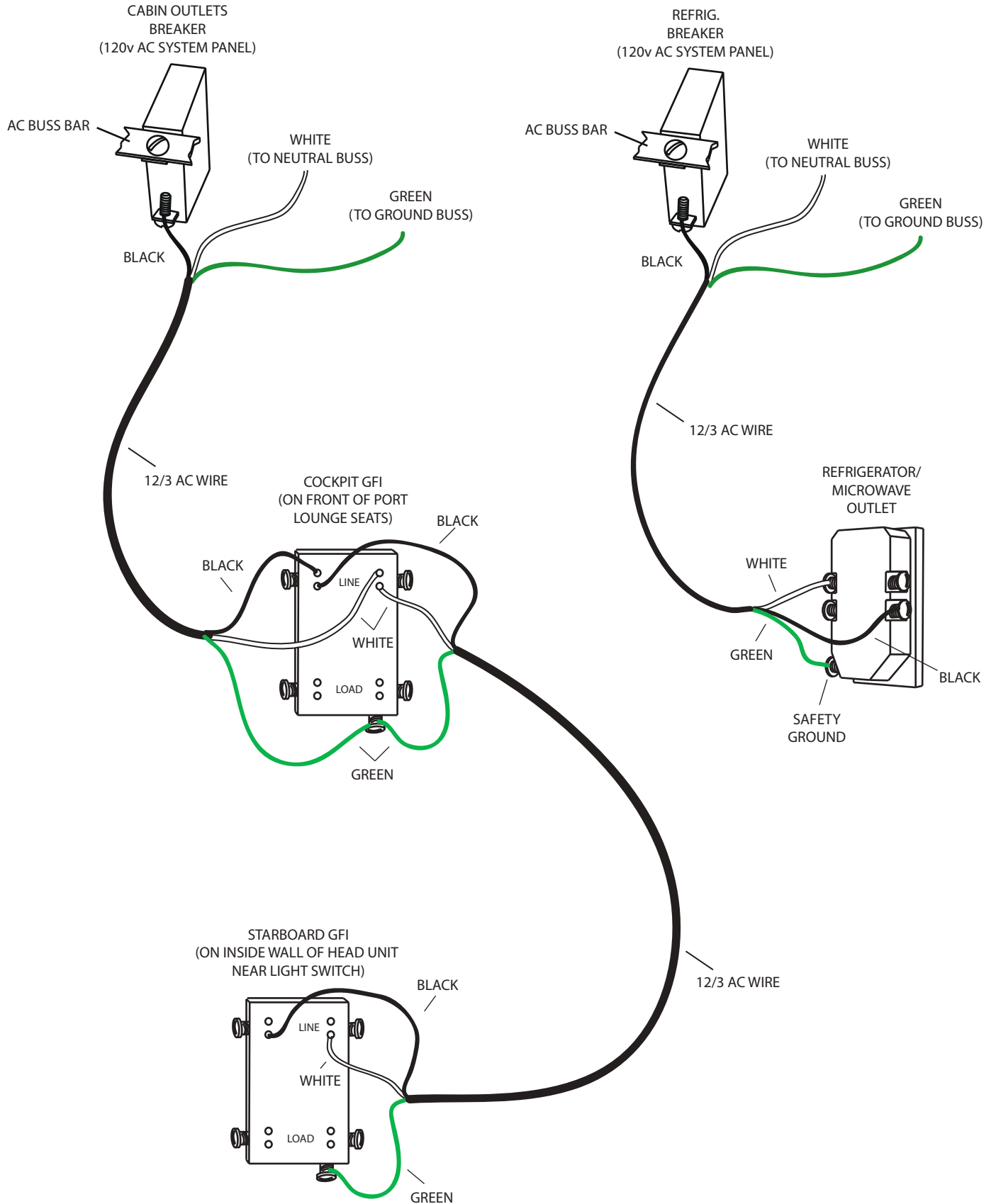

# BATTERY CHARGER

(AC CURRENT)

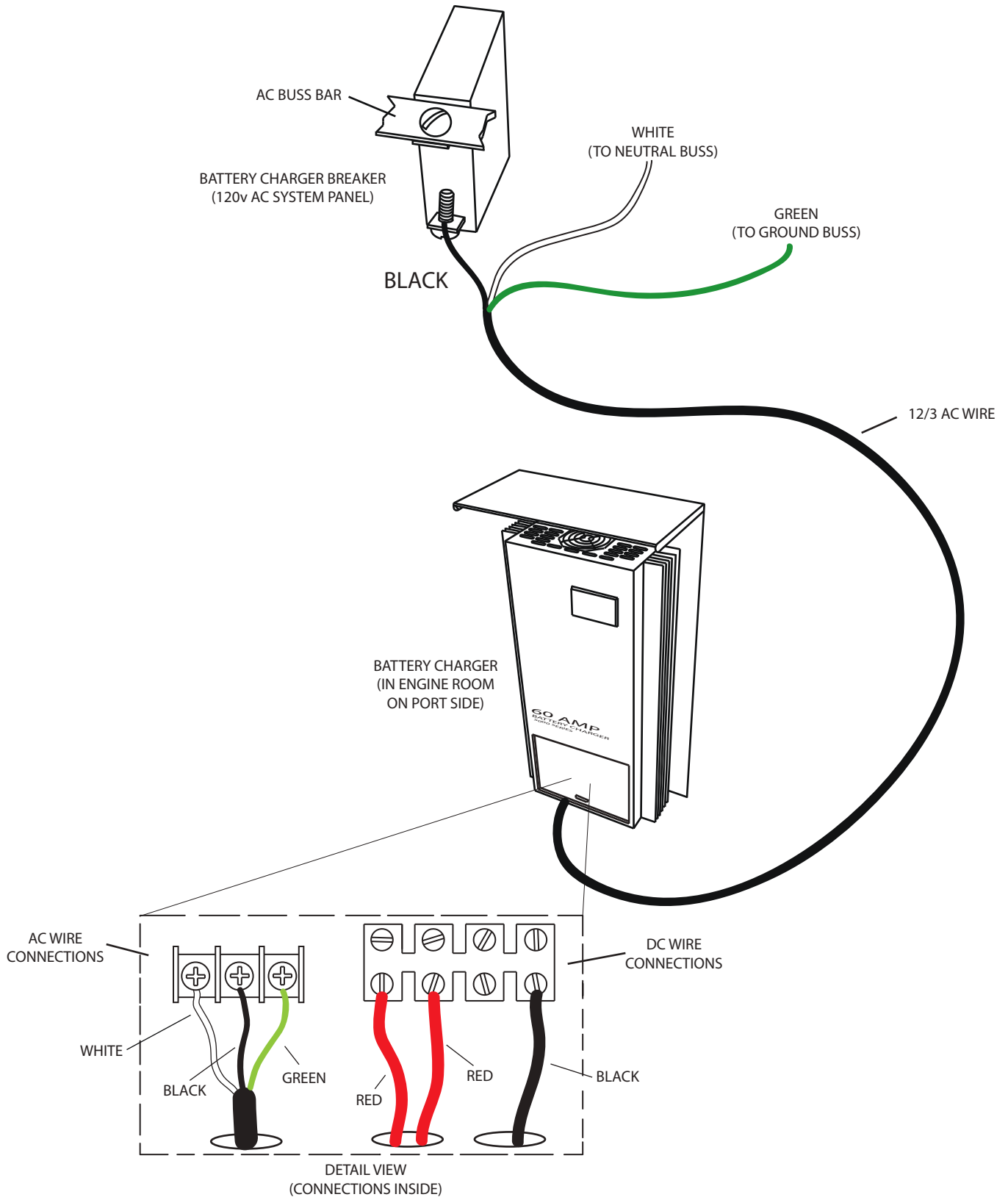

# CKPT REFRIGERATOR

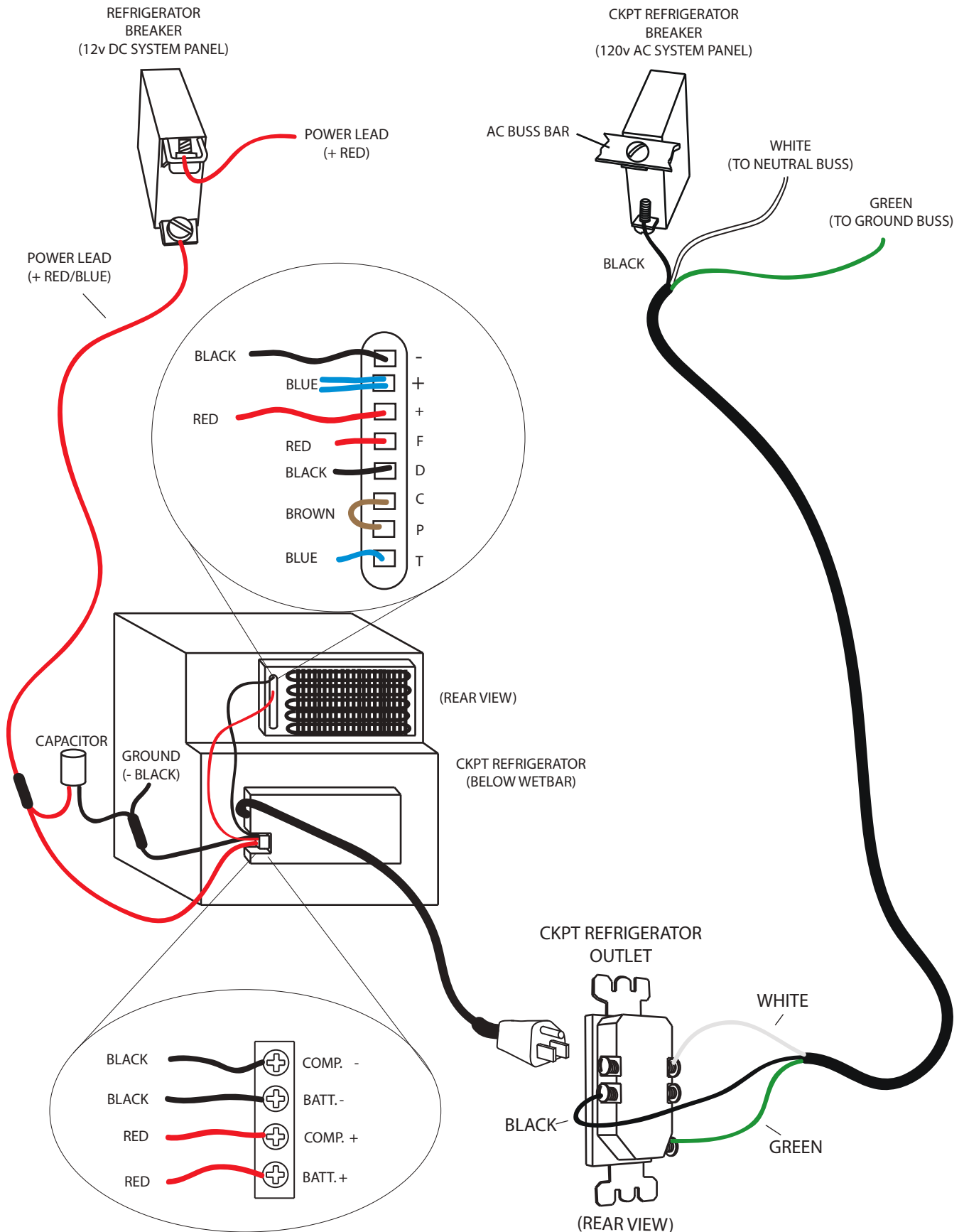

# WATER HEATER

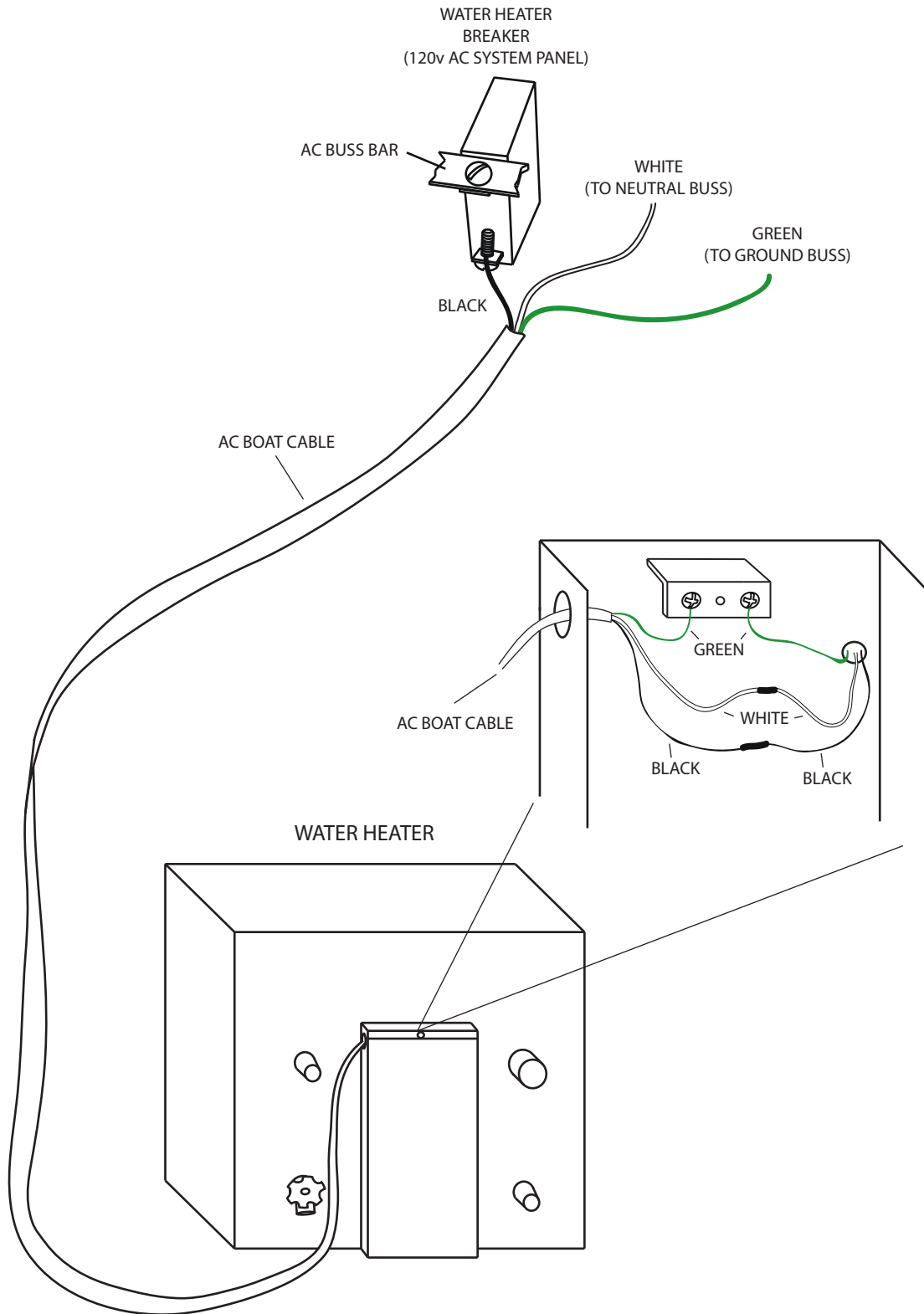

# BATTERY PARALLEL SWITCH PANEL

## BATTERY CHARGER

(DC CURRENT)

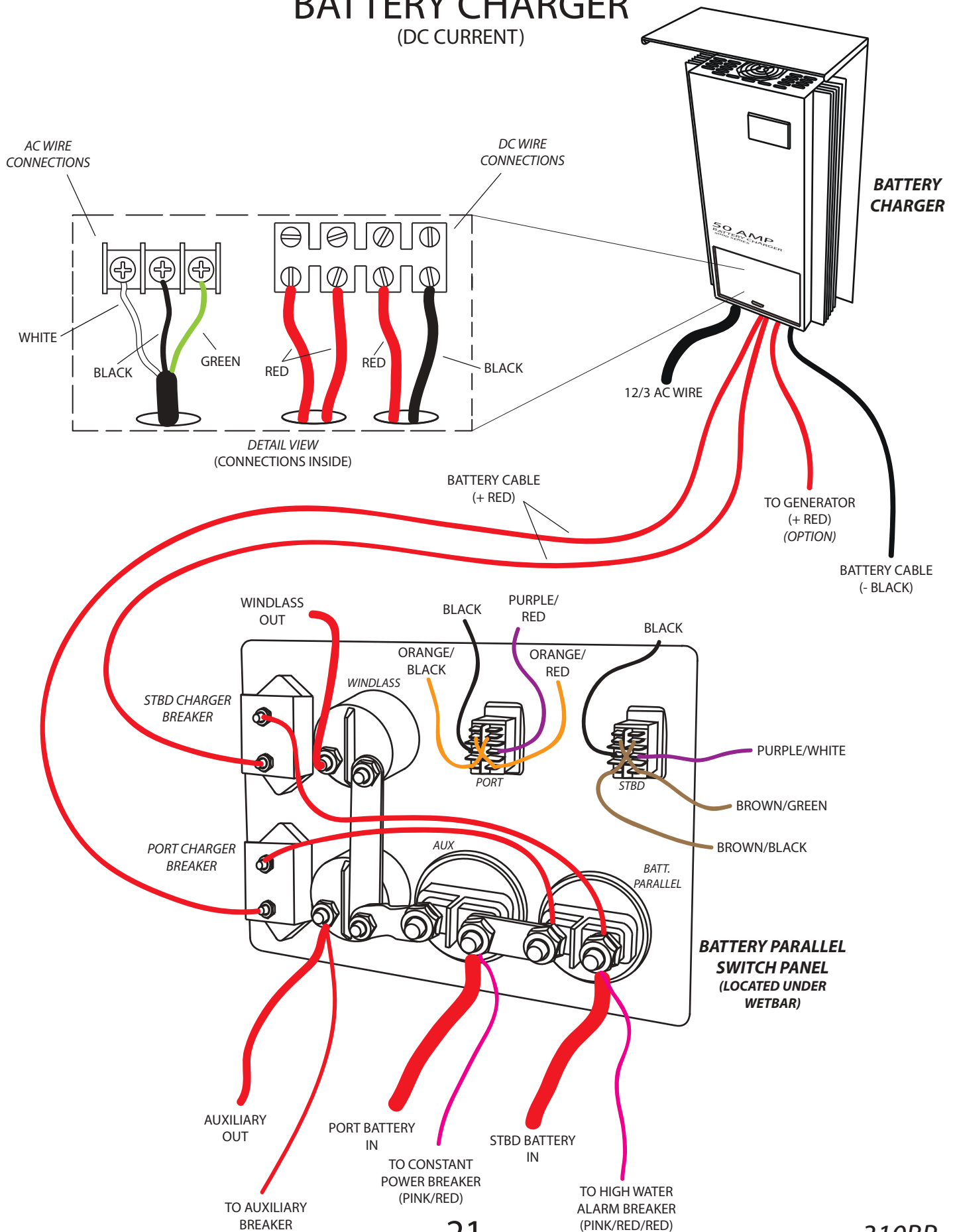

# BILGE BLOWERS

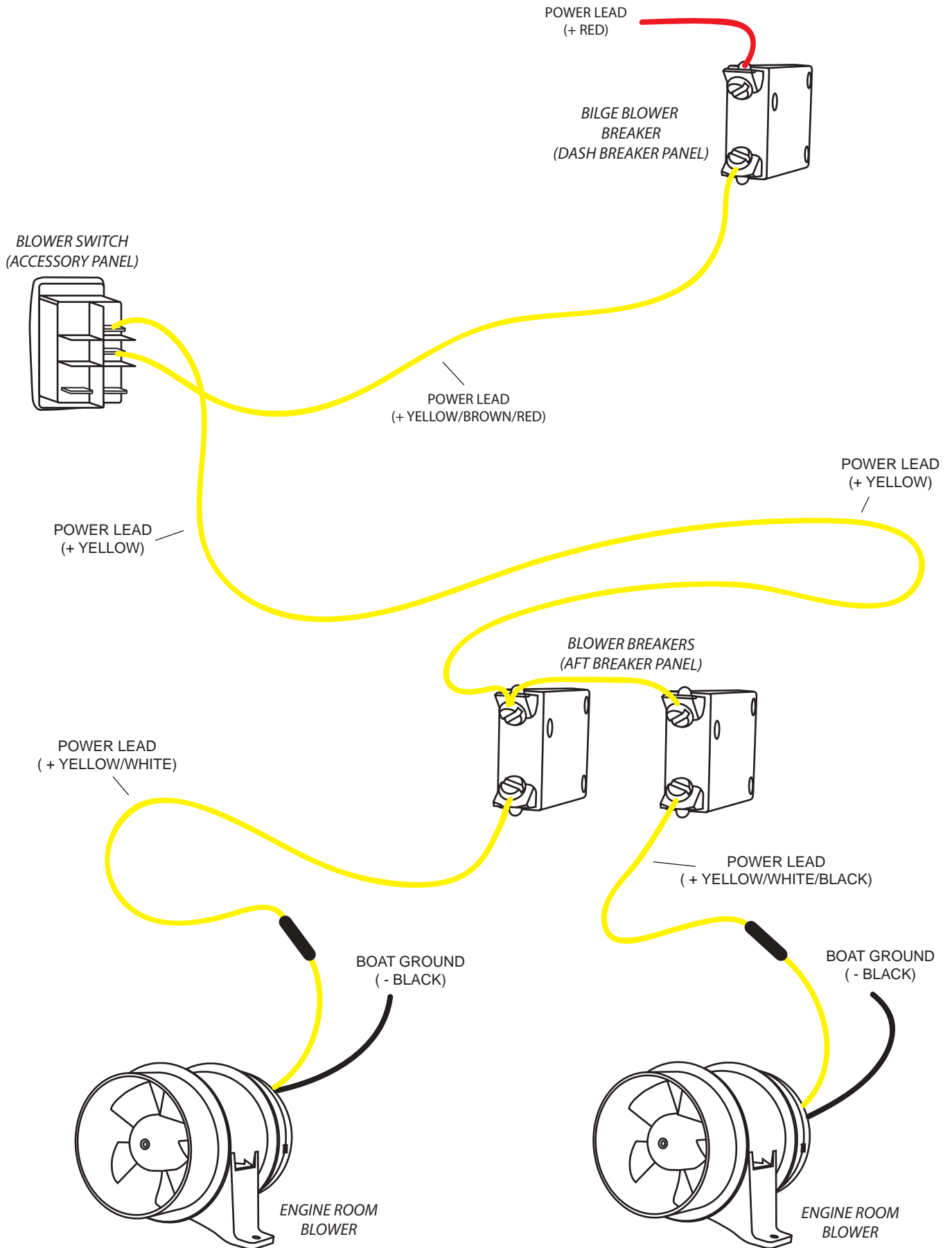

# CABIN BILGE PUMP

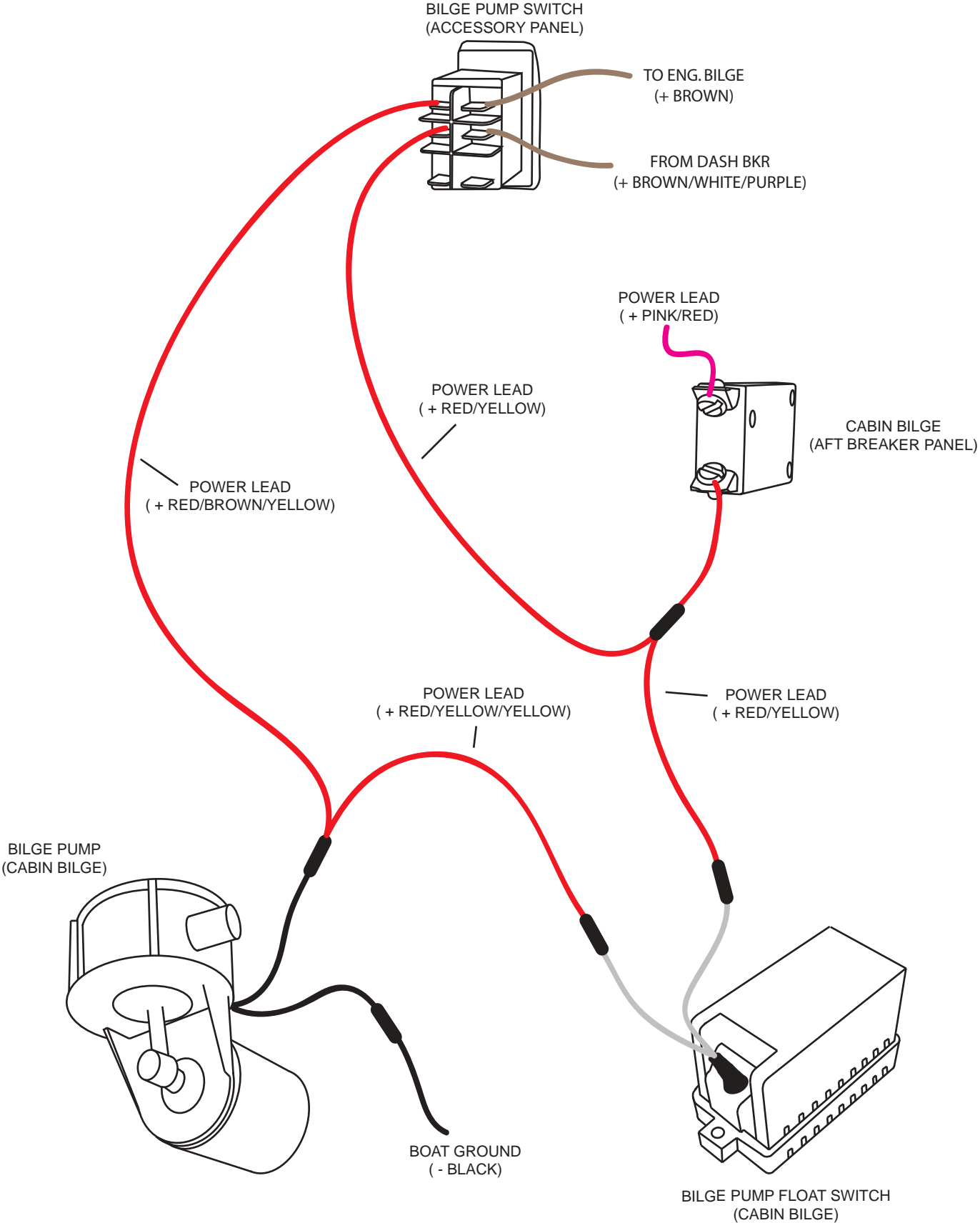



# ENGINE BILGE PUMP

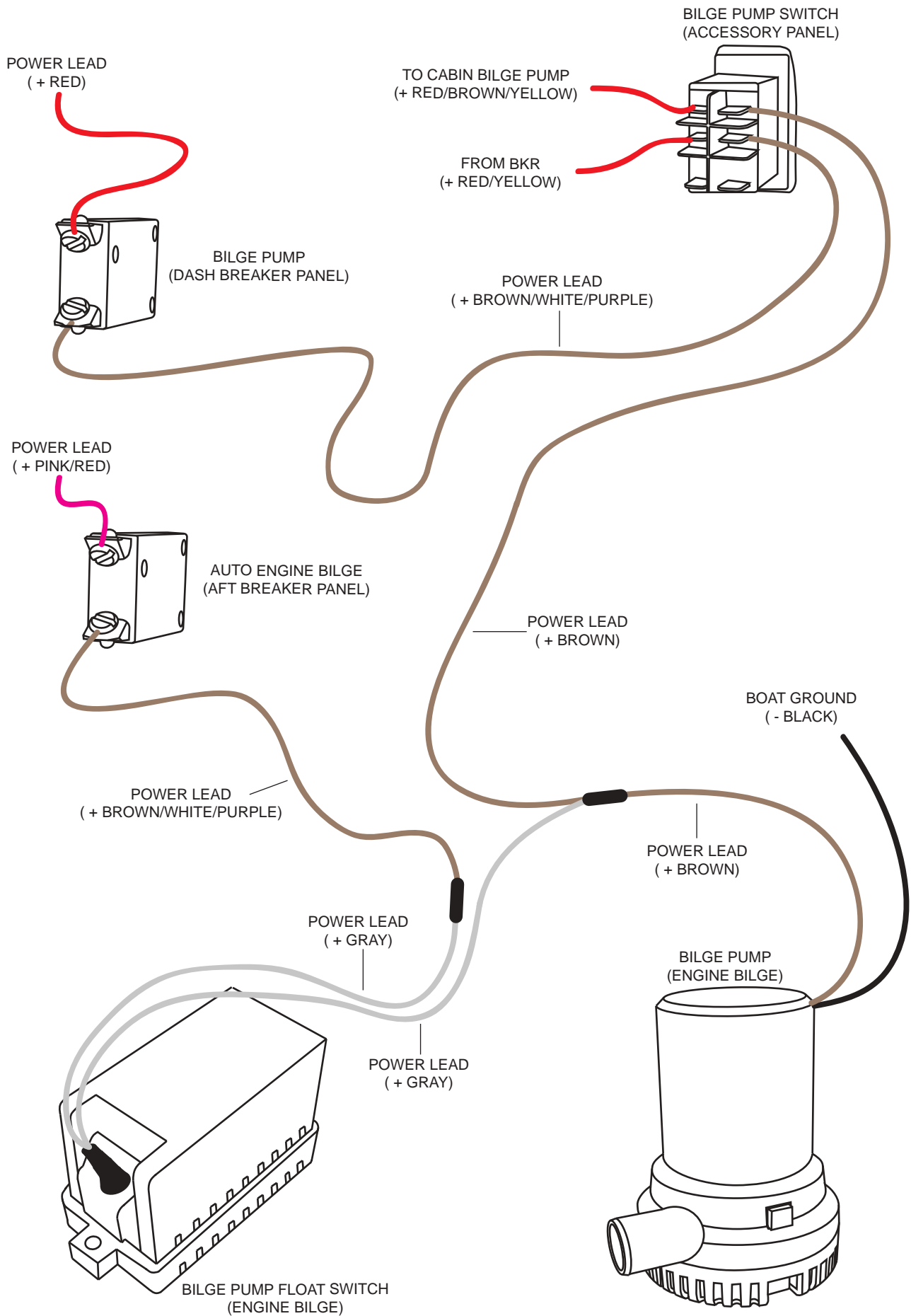

# CABINET LIGHT

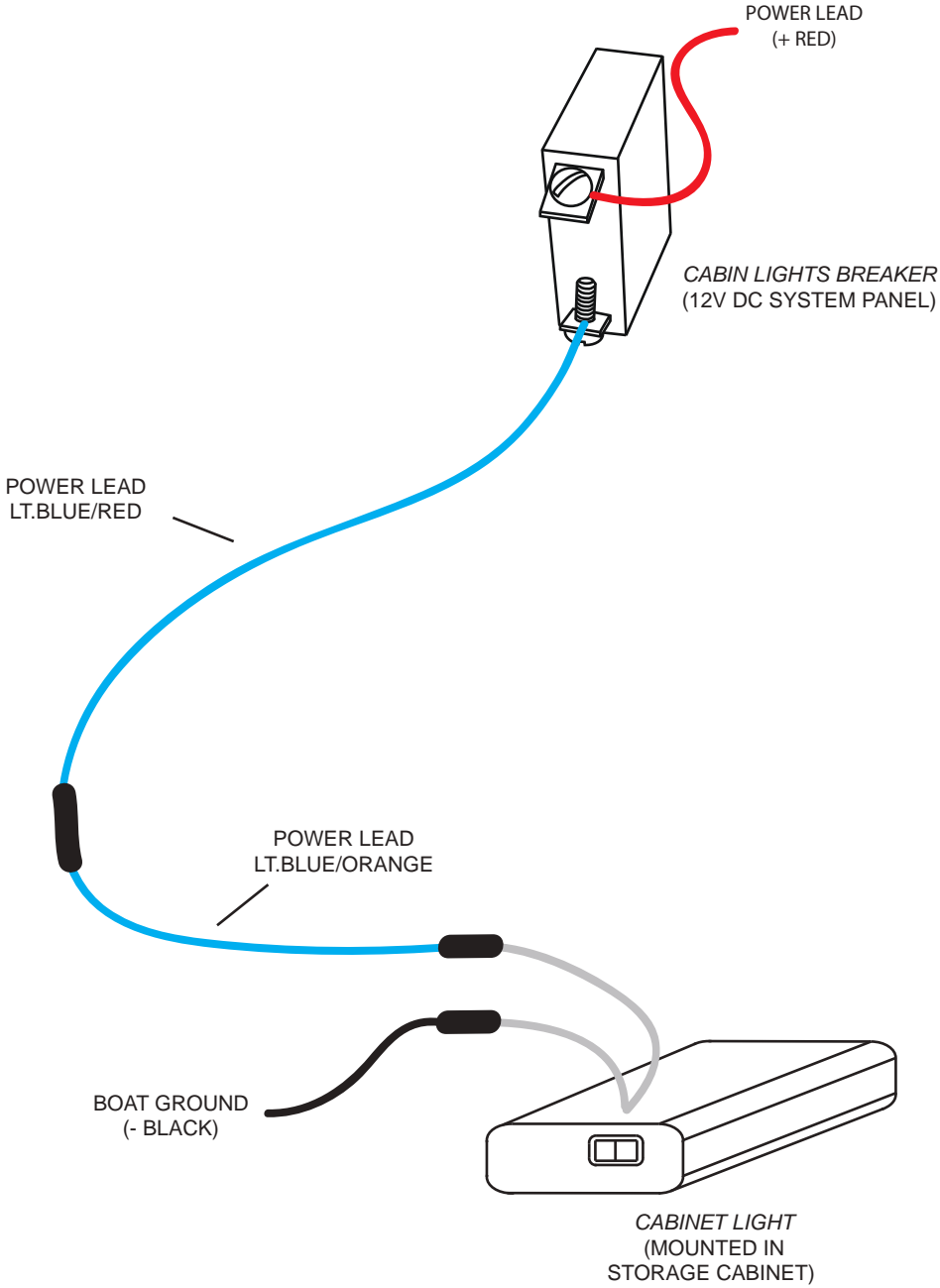

# CAPTAIN'S CALL (PORT ENGINE)

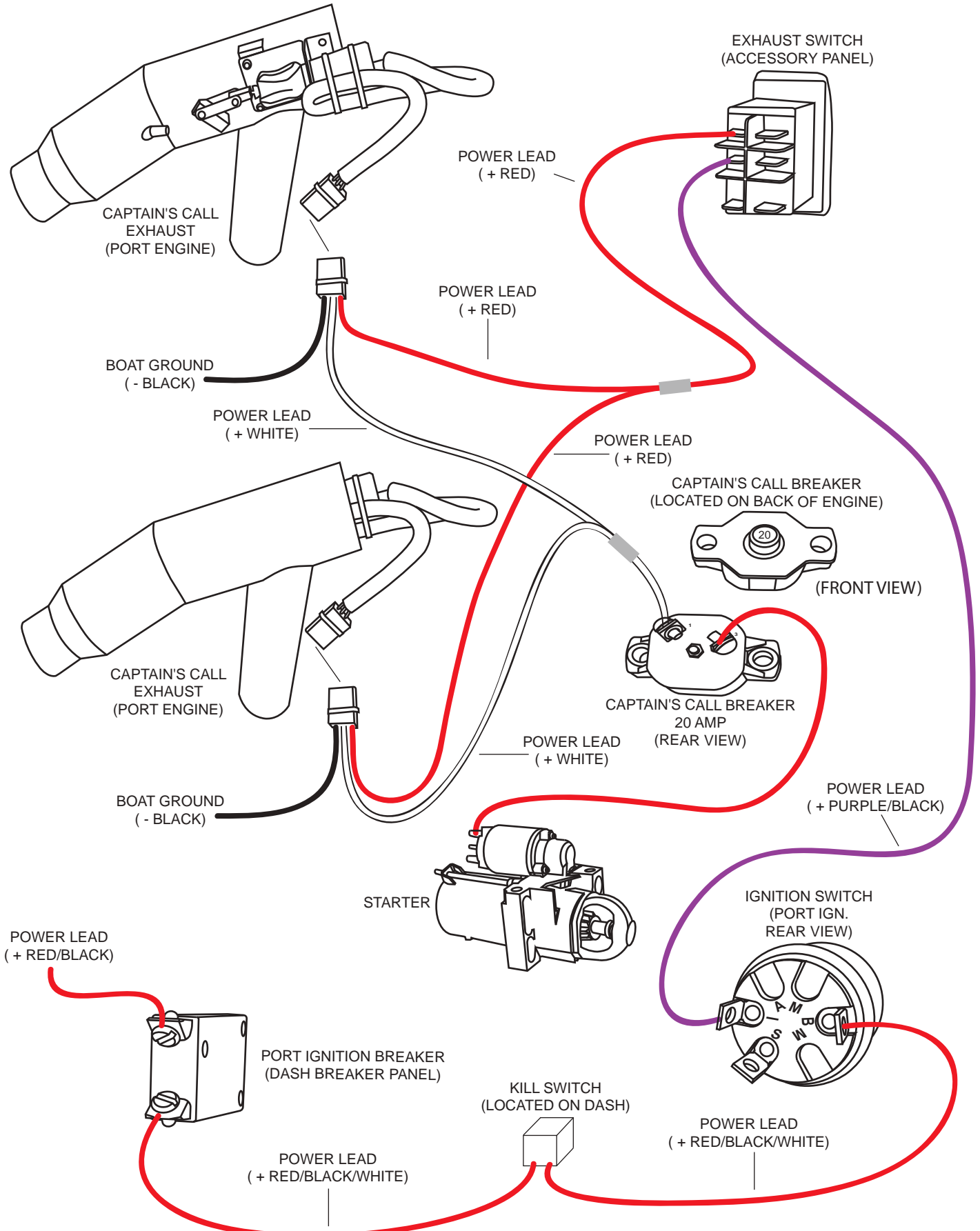

# CAPTAIN'S CALL

(STARBOARD ENGINE)

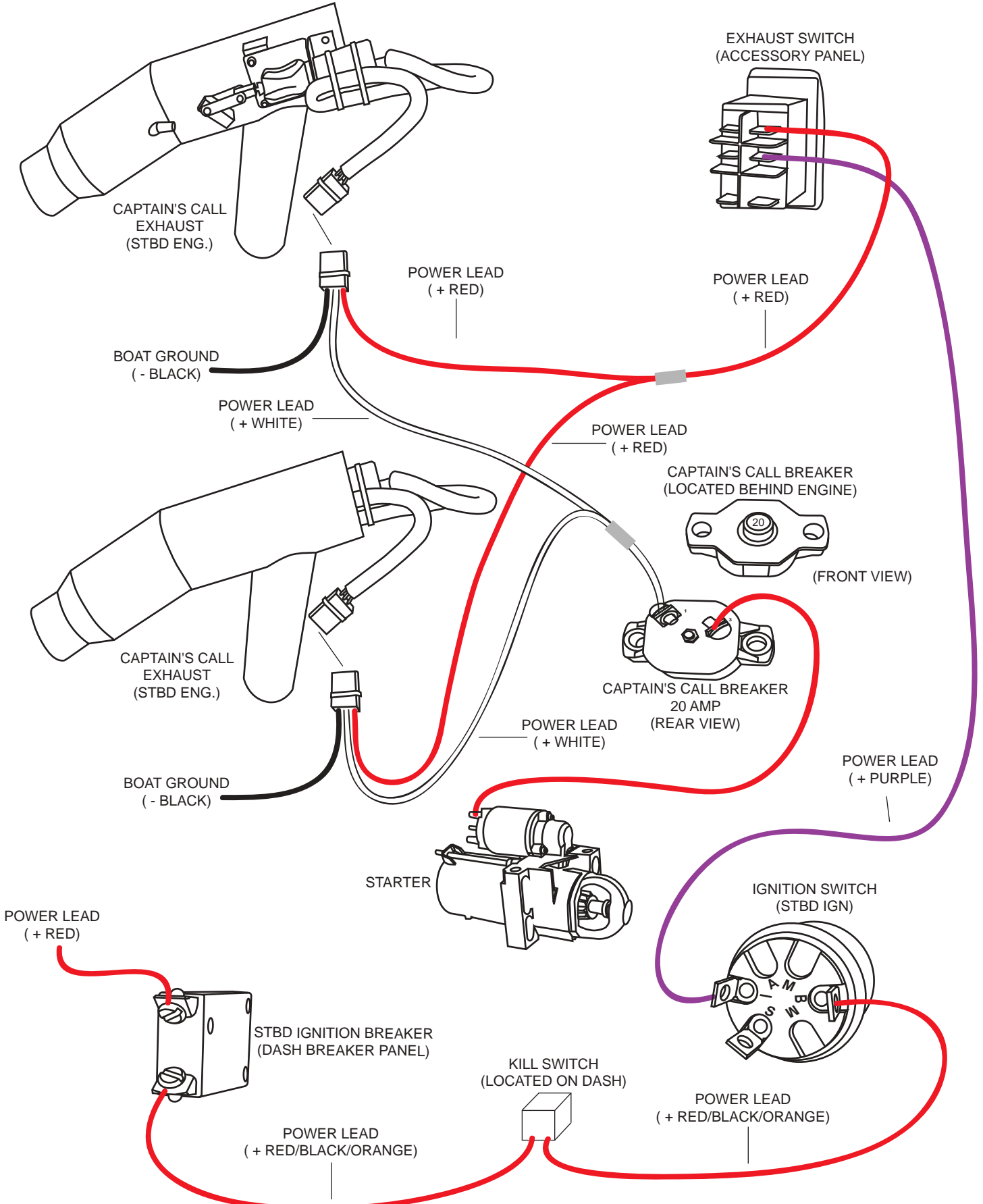

# CO DETECTOR

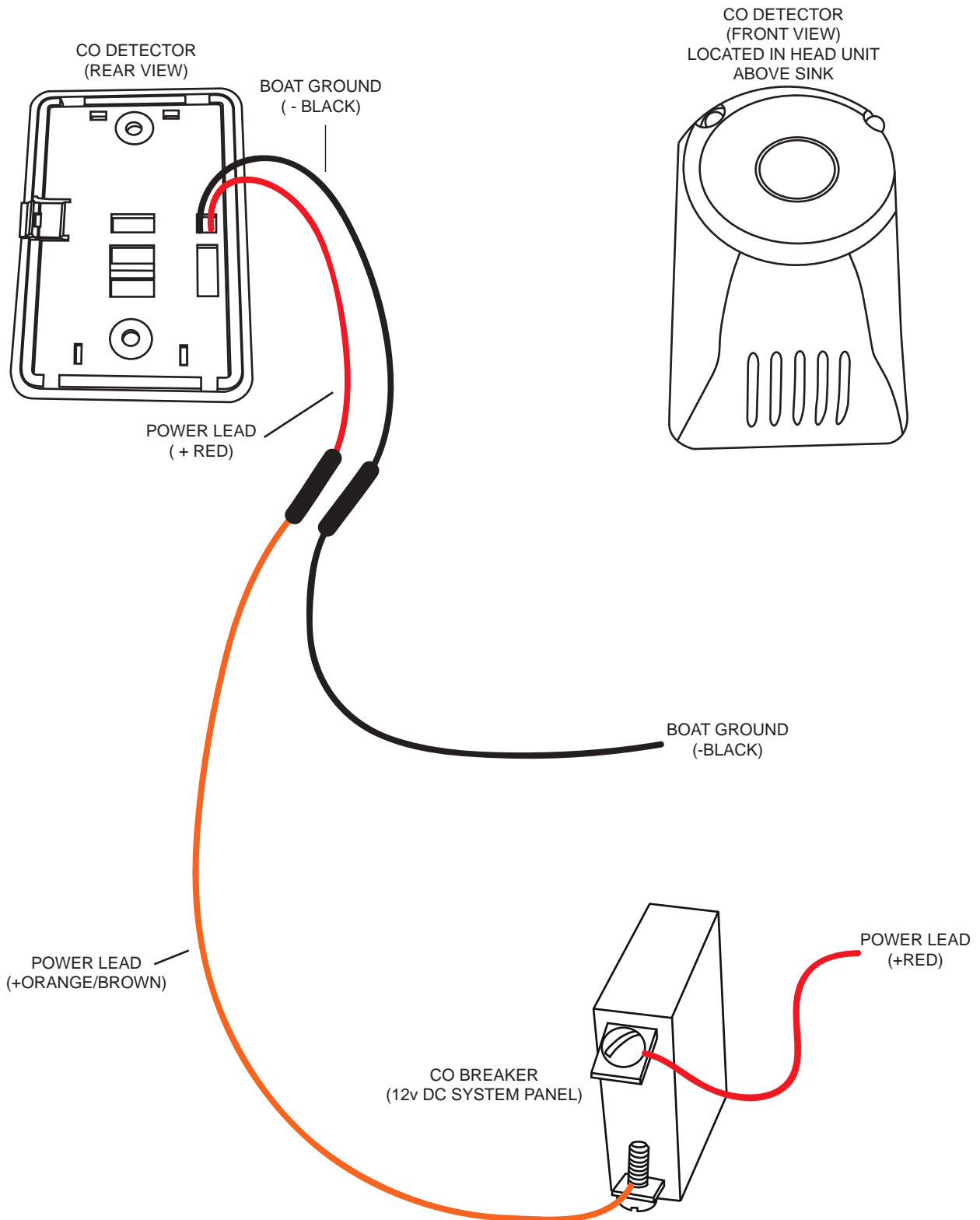

# COURTESY LIGHTS

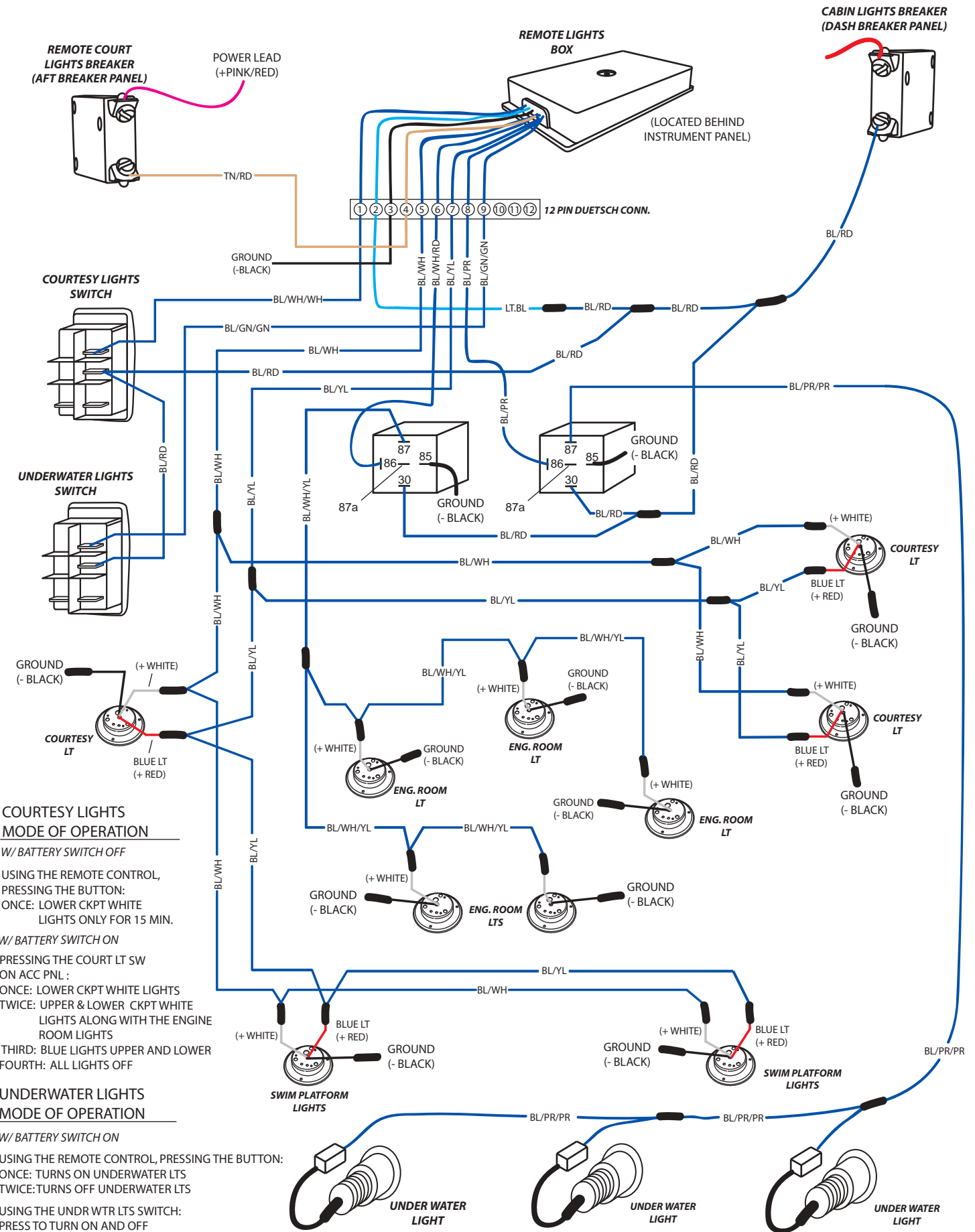

## COURTESY LIGHTS MODE OF OPERATION

### W/ BATTERY SWITCH OFF

USING THE REMOTE CONTROL,  
PRESSING THE BUTTON:  
ONCE: LOWER CKPT WHITE  
LIGHTS ONLY FOR 15 MIN.

### W/ BATTERY SWITCH ON

PRESSING THE COURT LT SW  
ON ACC PNL :  
ONCE: LOWER CKPT WHITE LIGHTS  
TWICE: UPPER & LOWER CKPT WHITE  
LIGHTS ALONG WITH THE ENGINE  
ROOM LIGHTS  
THIRD: BLUE LIGHTS UPPER AND LOWER  
FOURTH: ALL LIGHTS OFF

## UNDERWATER LIGHTS MODE OF OPERATION

### W/ BATTERY SWITCH ON

USING THE REMOTE CONTROL, PRESSING THE BUTTON:  
ONCE: TURNS ON UNDERWATER LTS  
TWICE: TURNS OFF UNDERWATER LTS

USING THE UNDR WTR LTS SWITCH:  
PRESS TO TURN ON AND OFF

# 12V DASH OUTLET

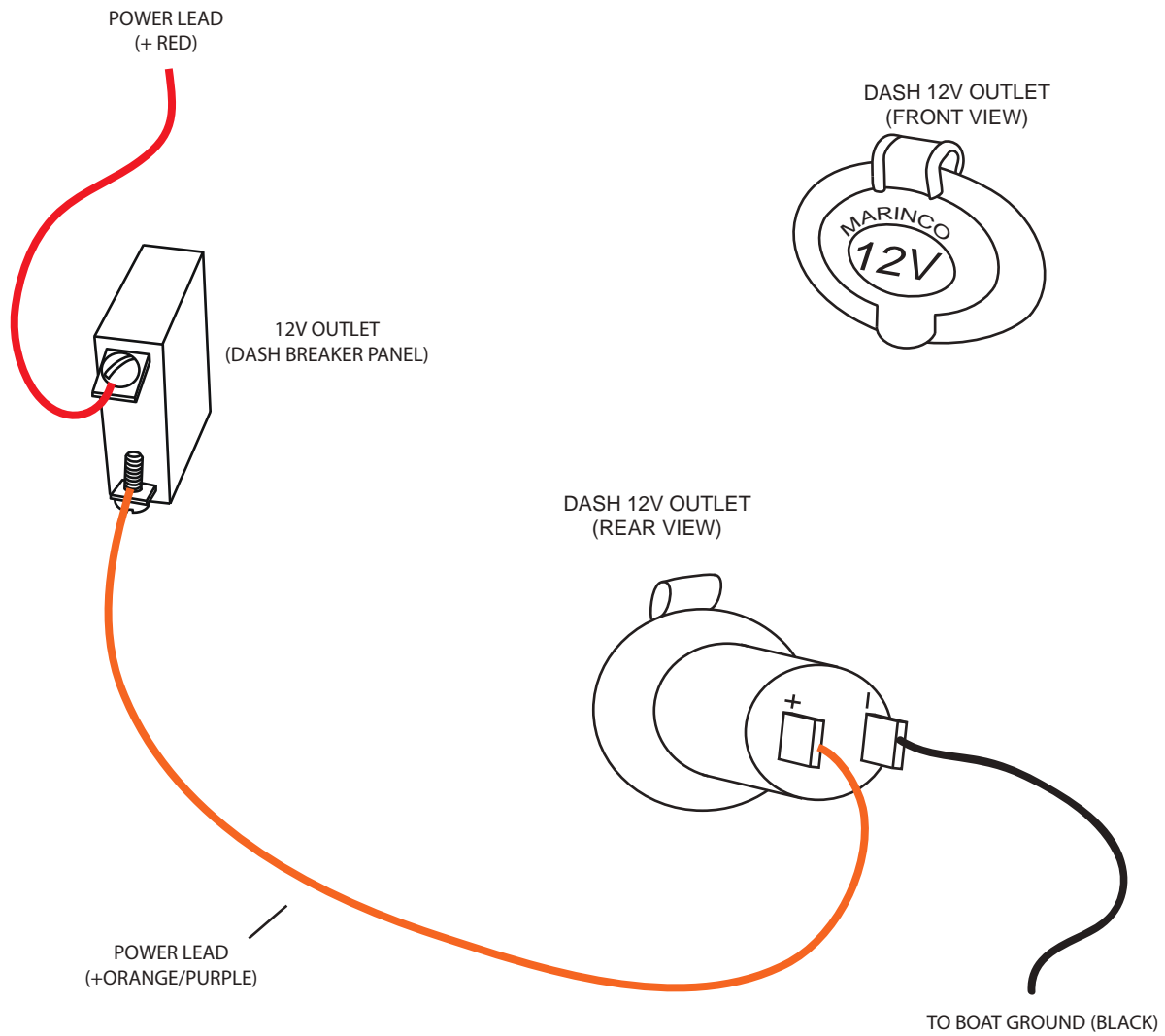

# DEPTH SOUNDER

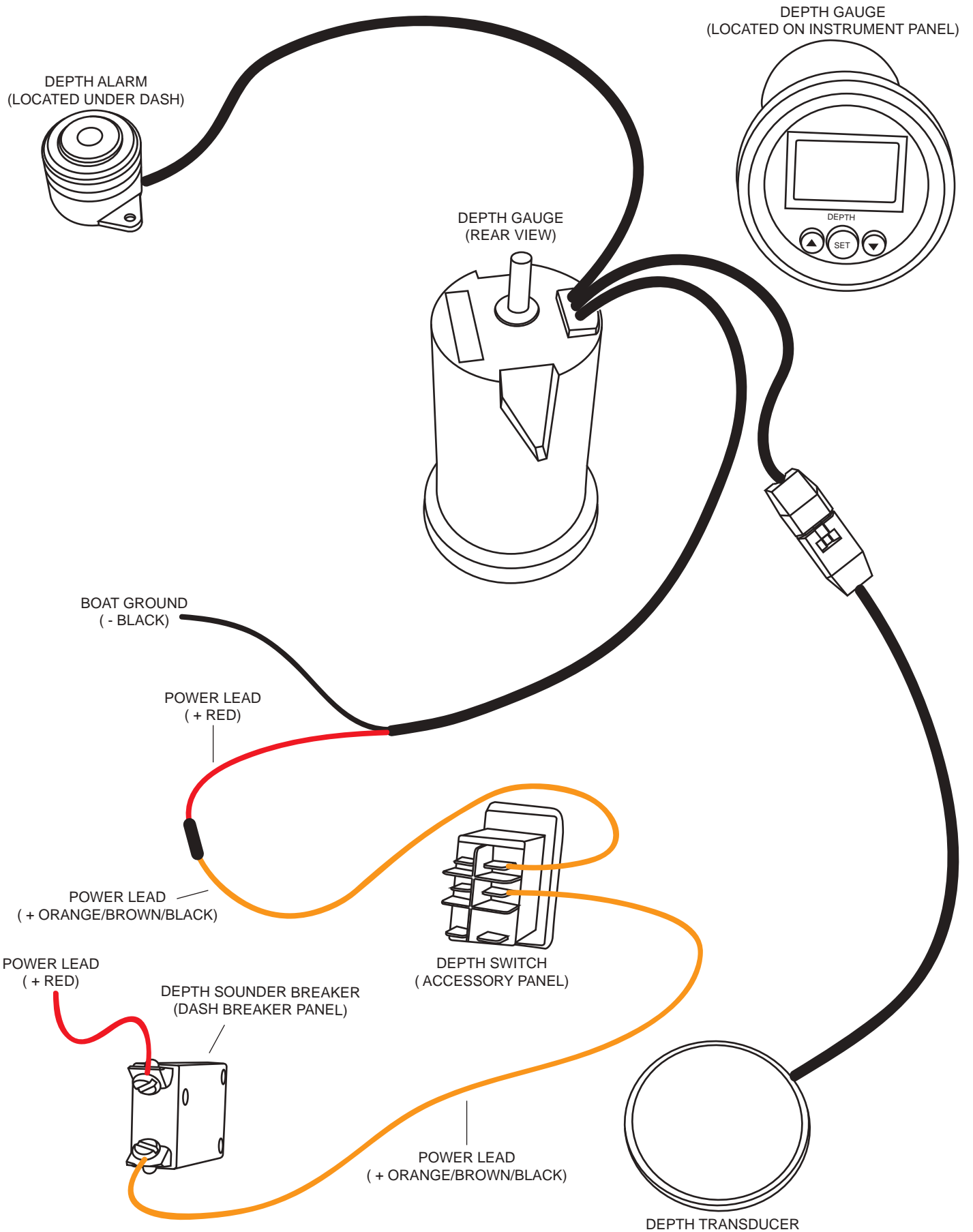



# DOCKING LIGHTS

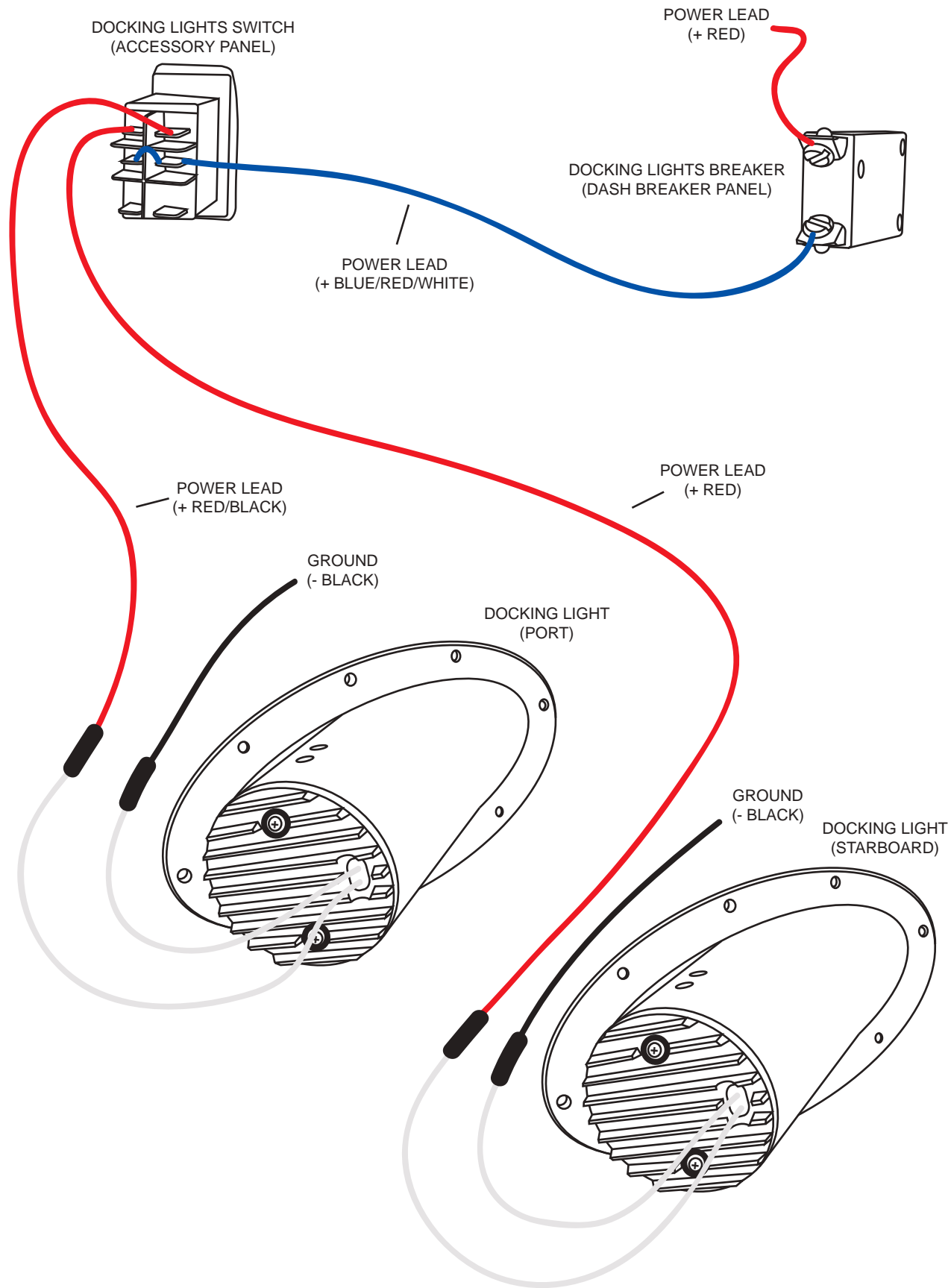



# FIRE EXTINGUISHER SYSTEM

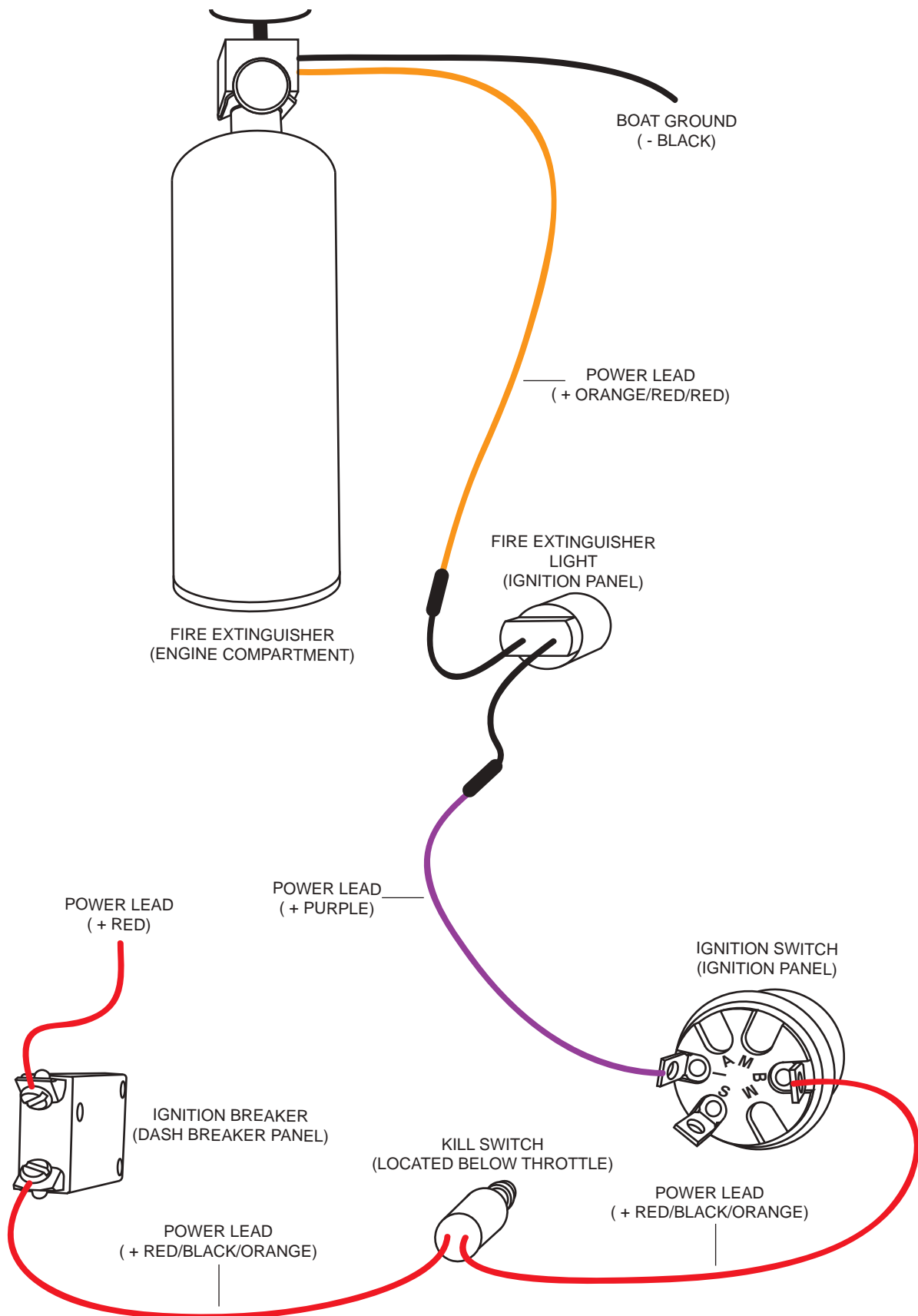

# FUME DETECTOR

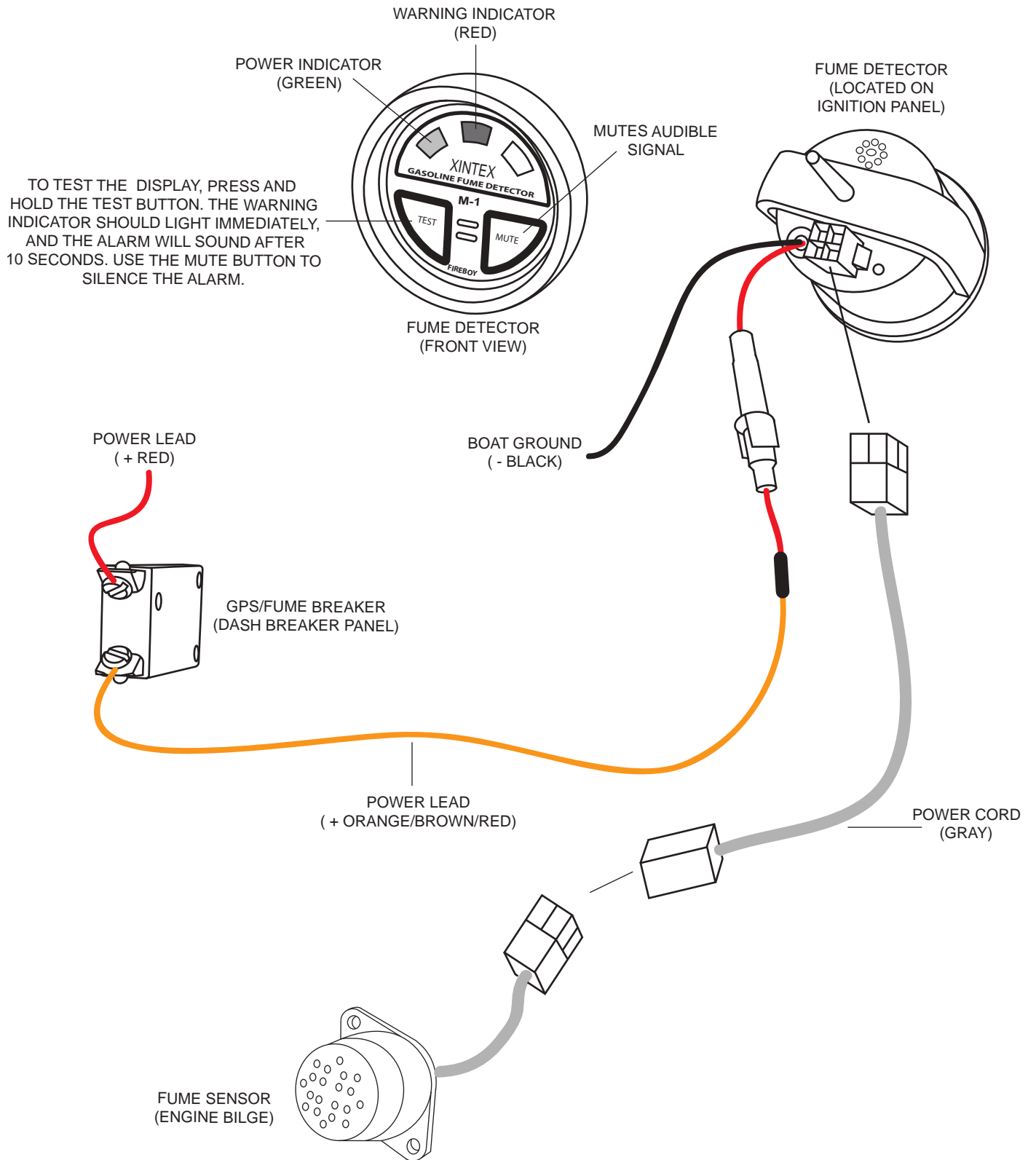

# HEAD BLOWER

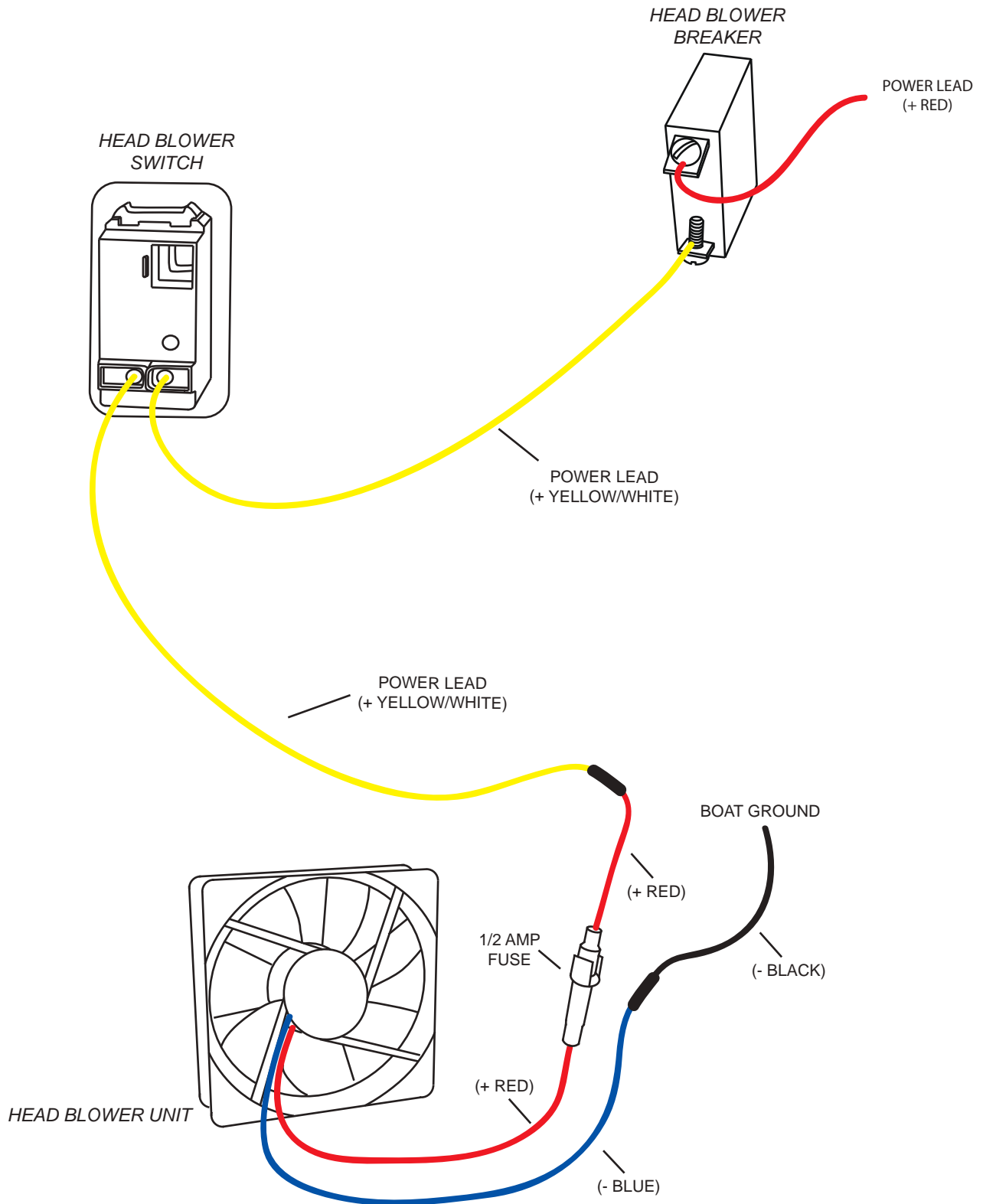

# HEAD UNIT LIGHT

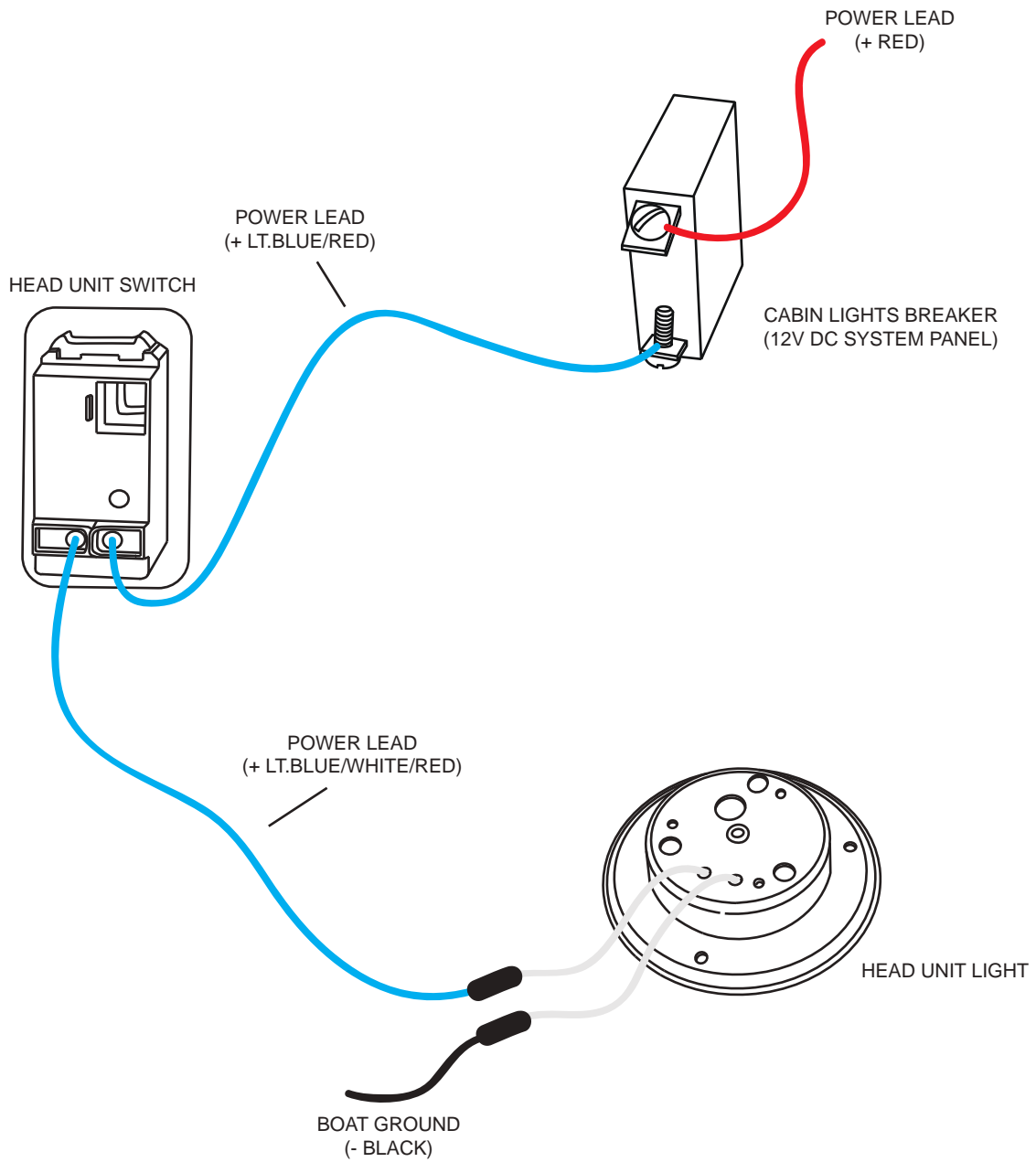

# HELM VIEW

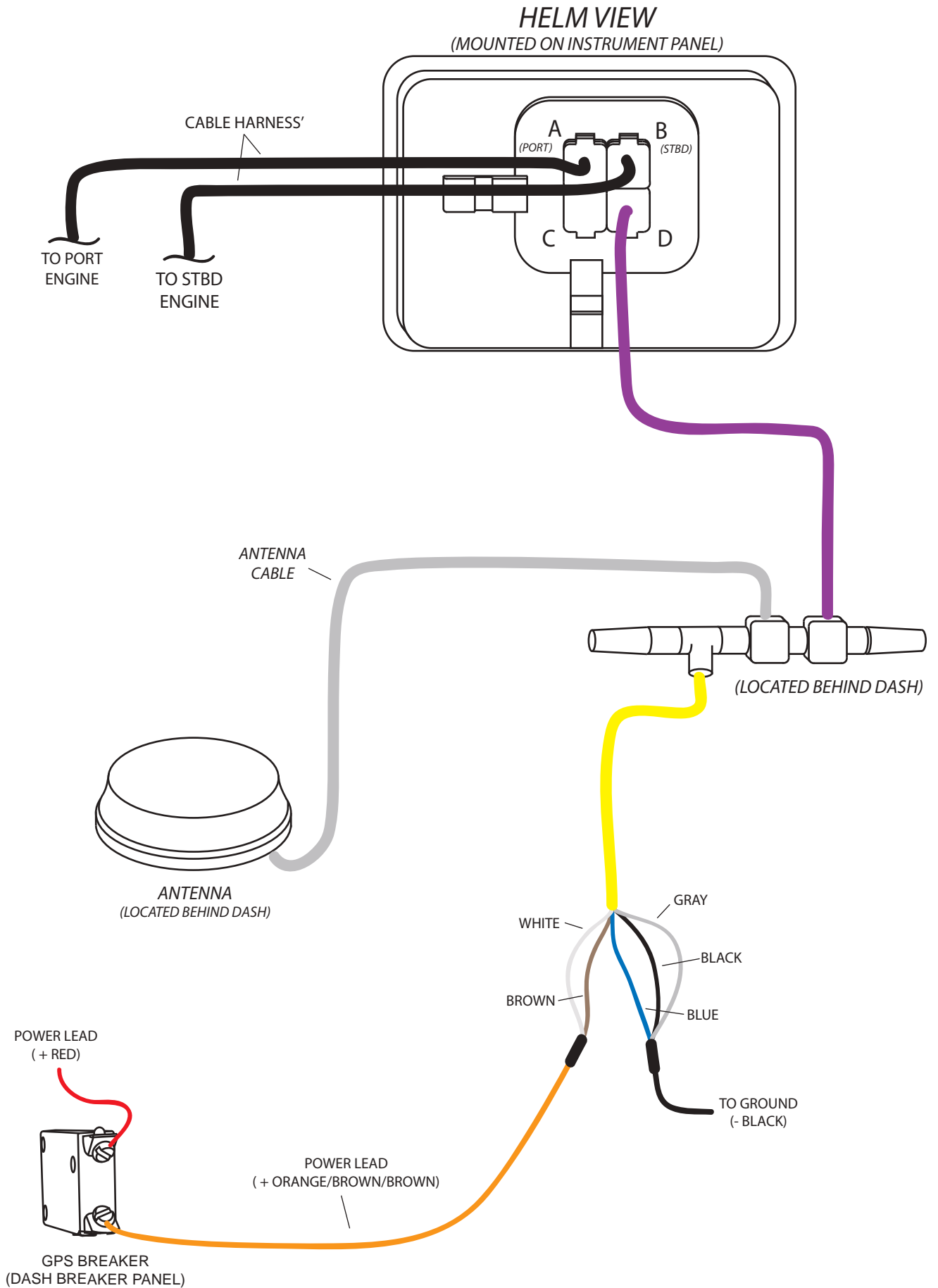

# HIGH WATER ALARM

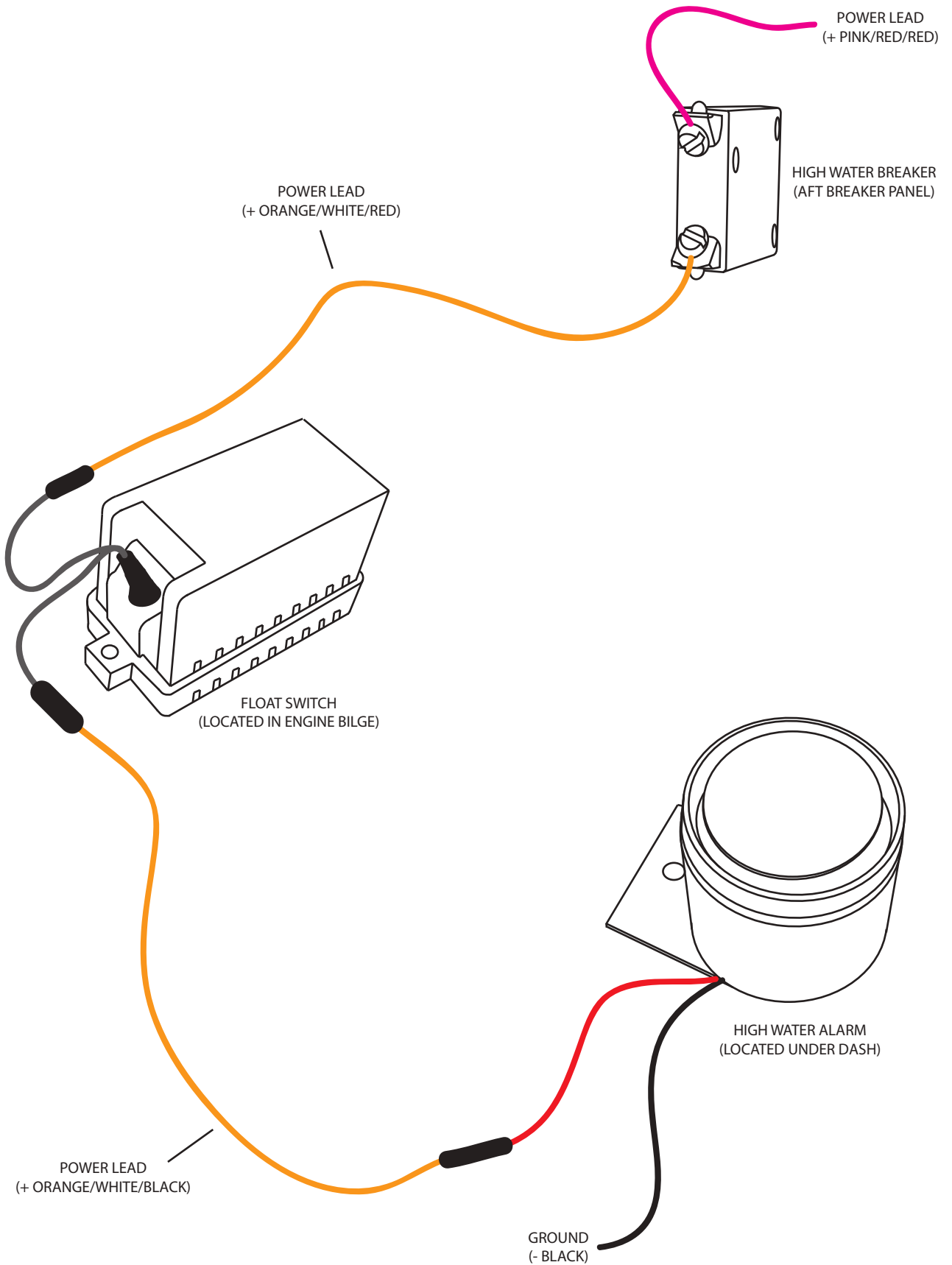



# HORN

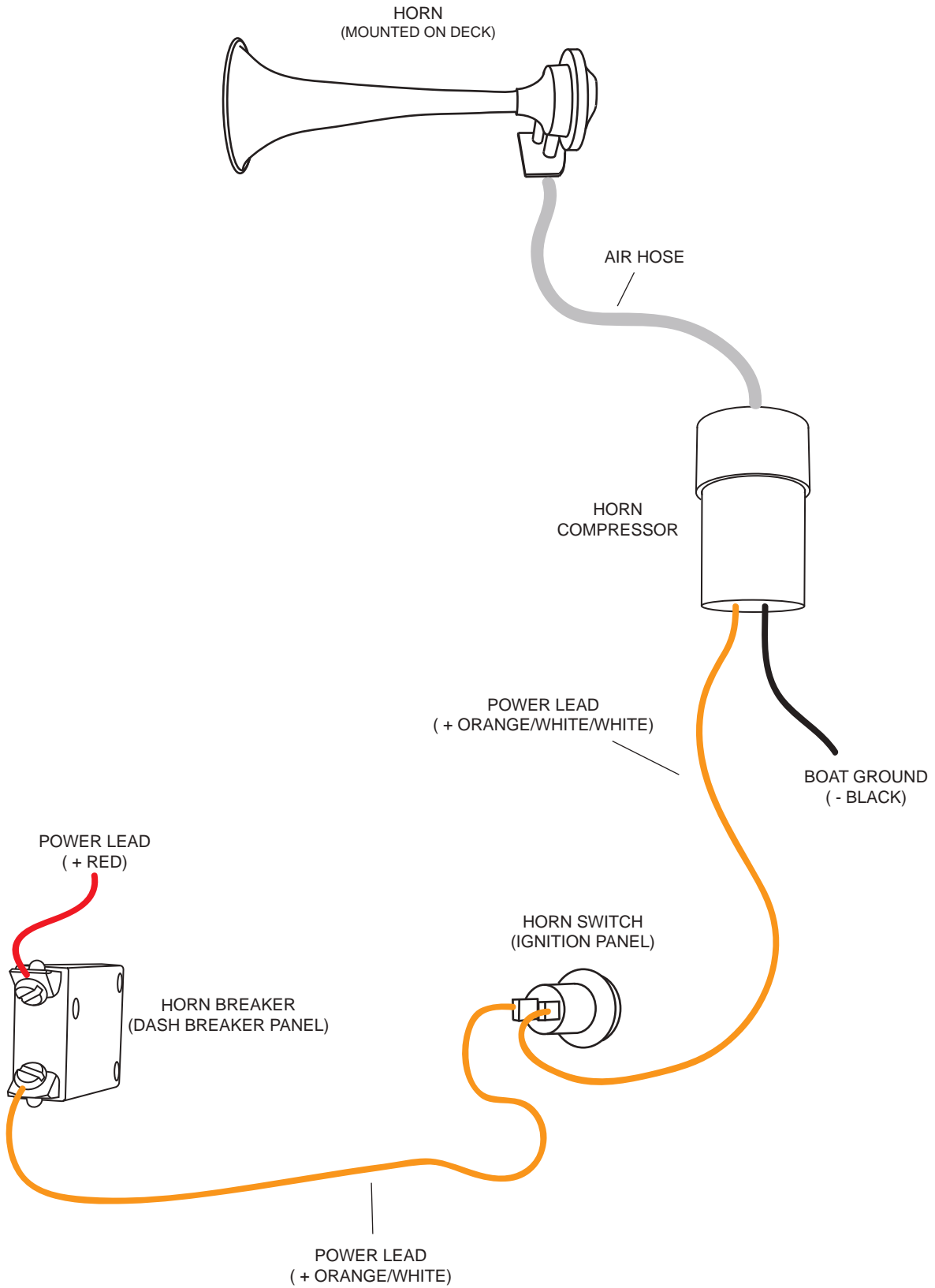

# IGNITION

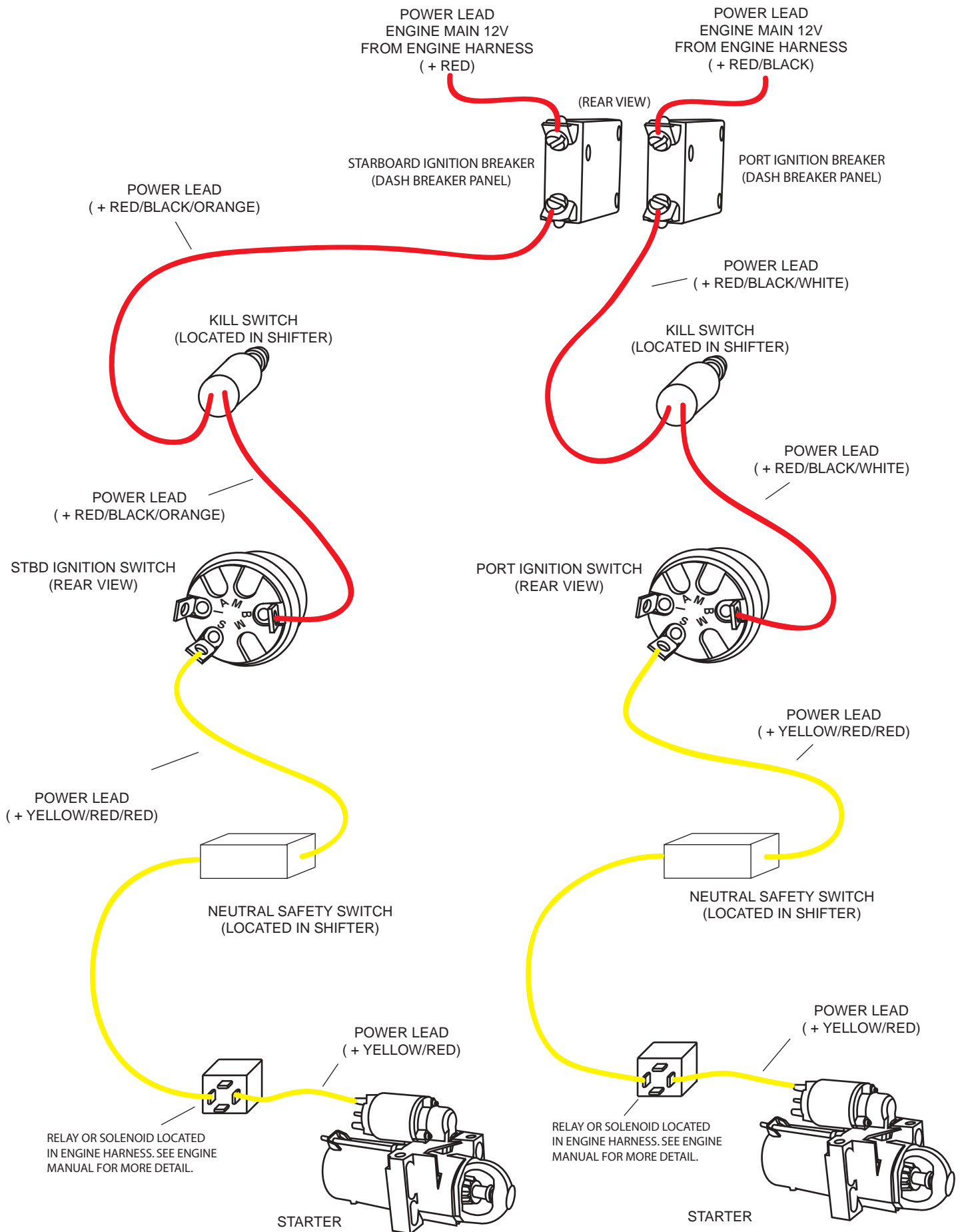

# MACERATOR

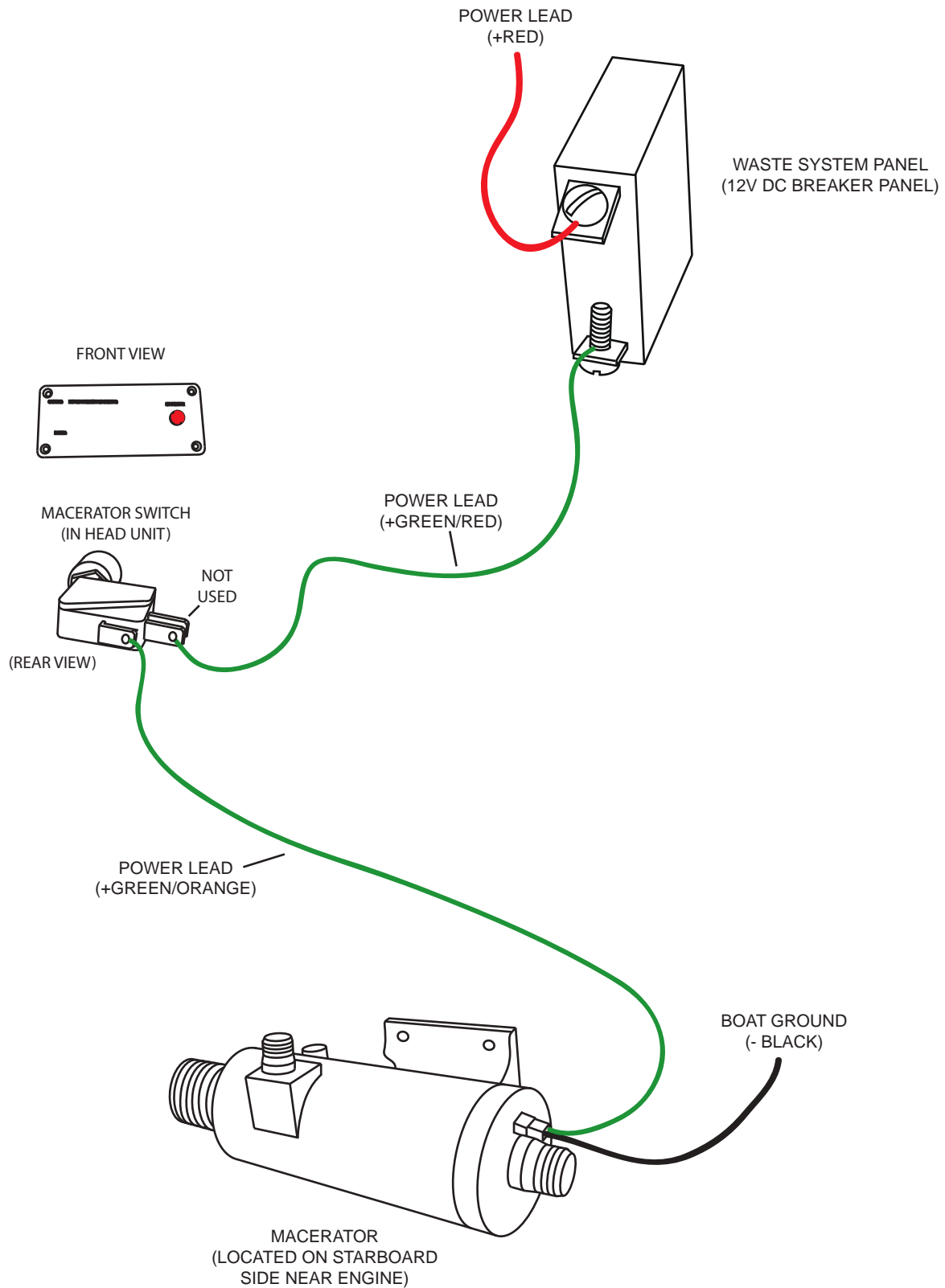

# MERCATHODE

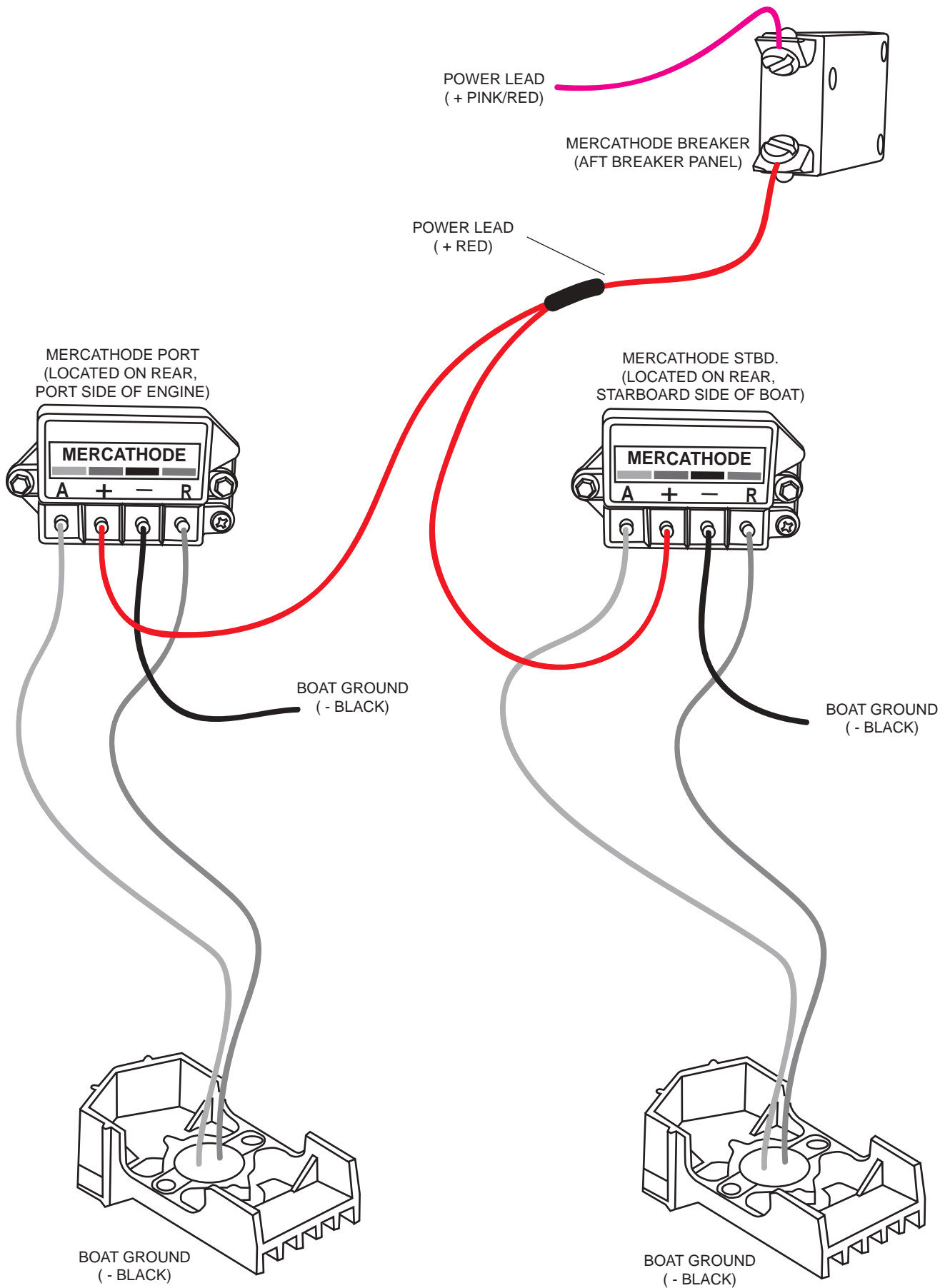

# NAVIGATION/ANCHOR LIGHTS

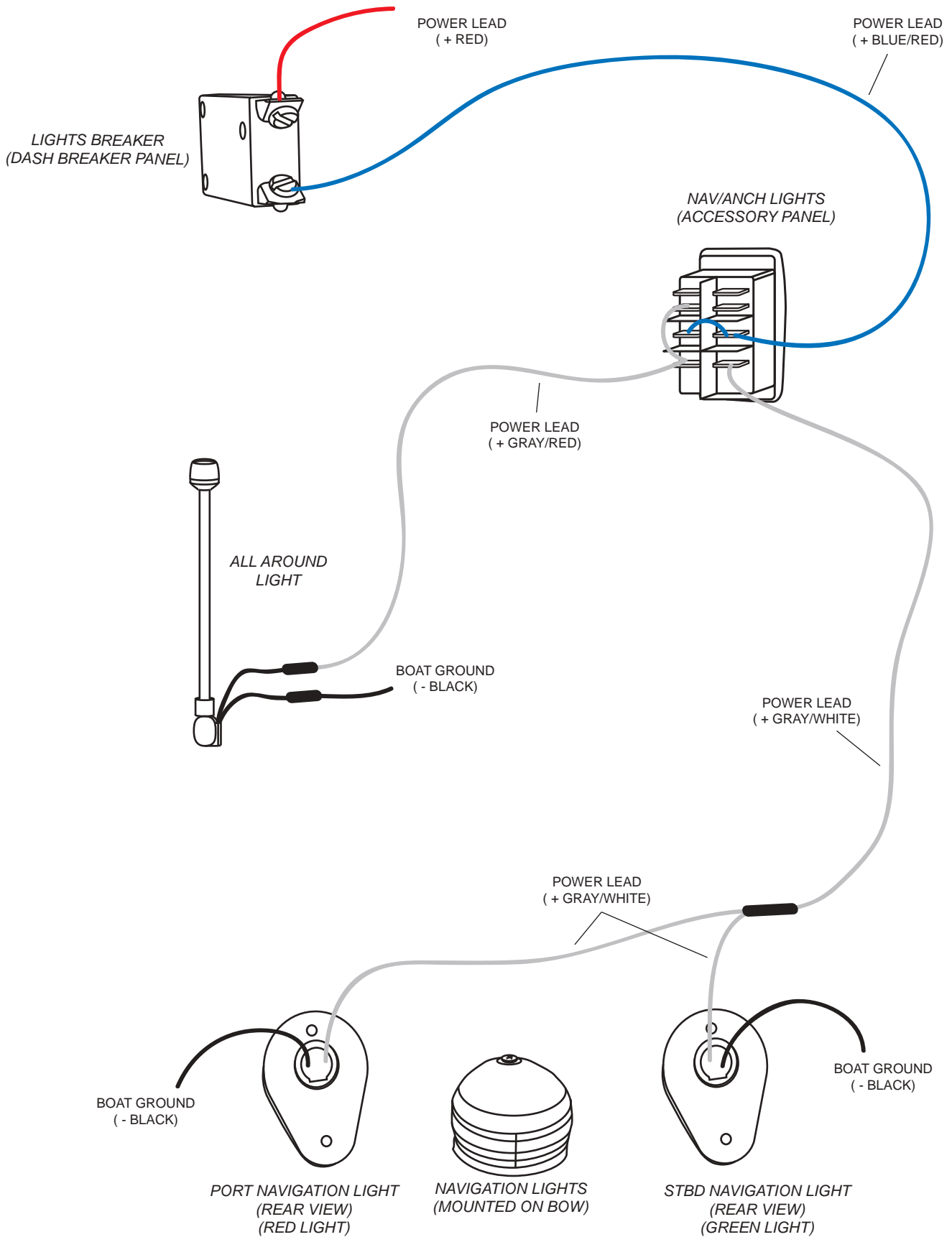

# NAVIGATION SYSTEM

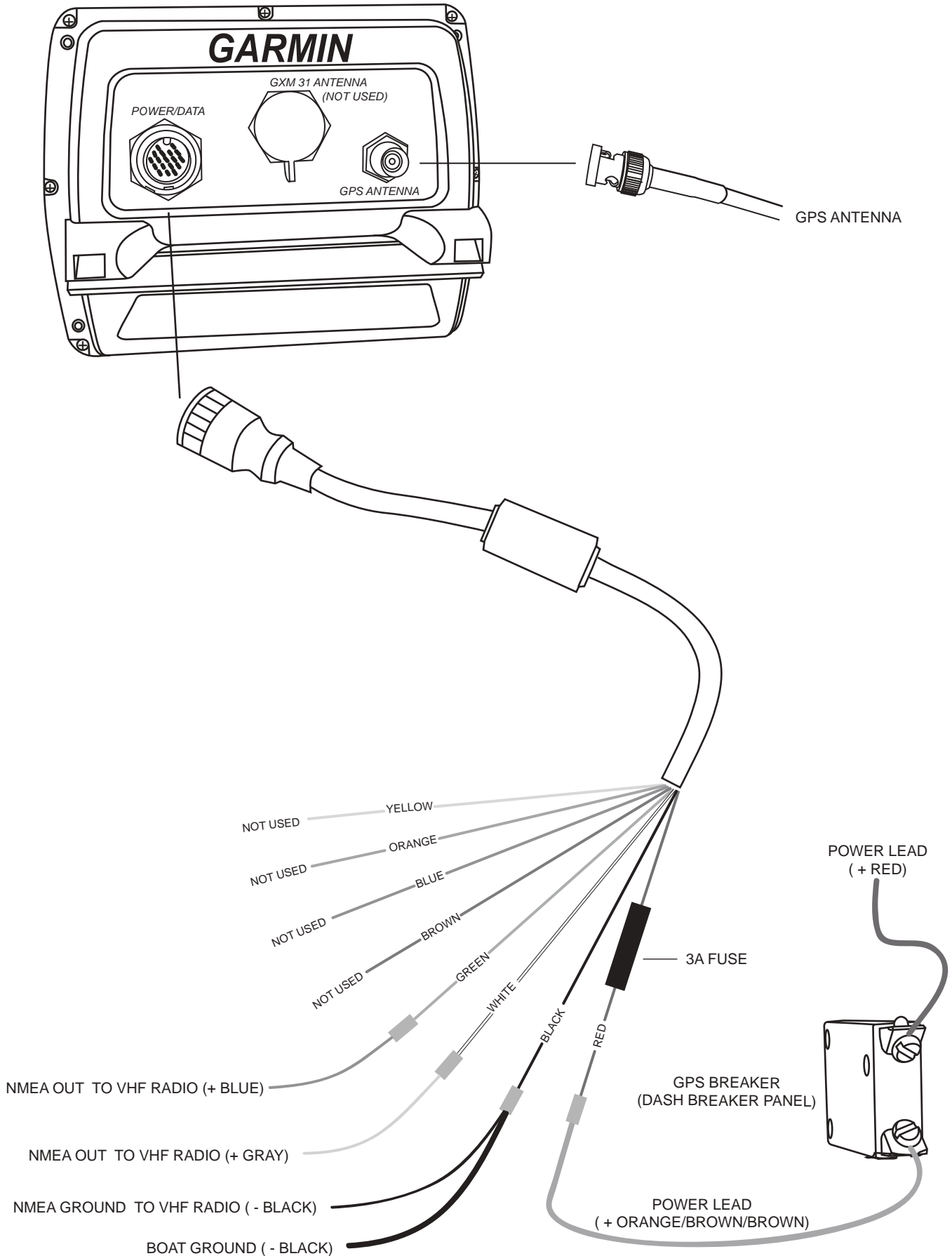

# OUTDRIVE PUMP

(MERCURY ENGINES NON SMART CRAFT)

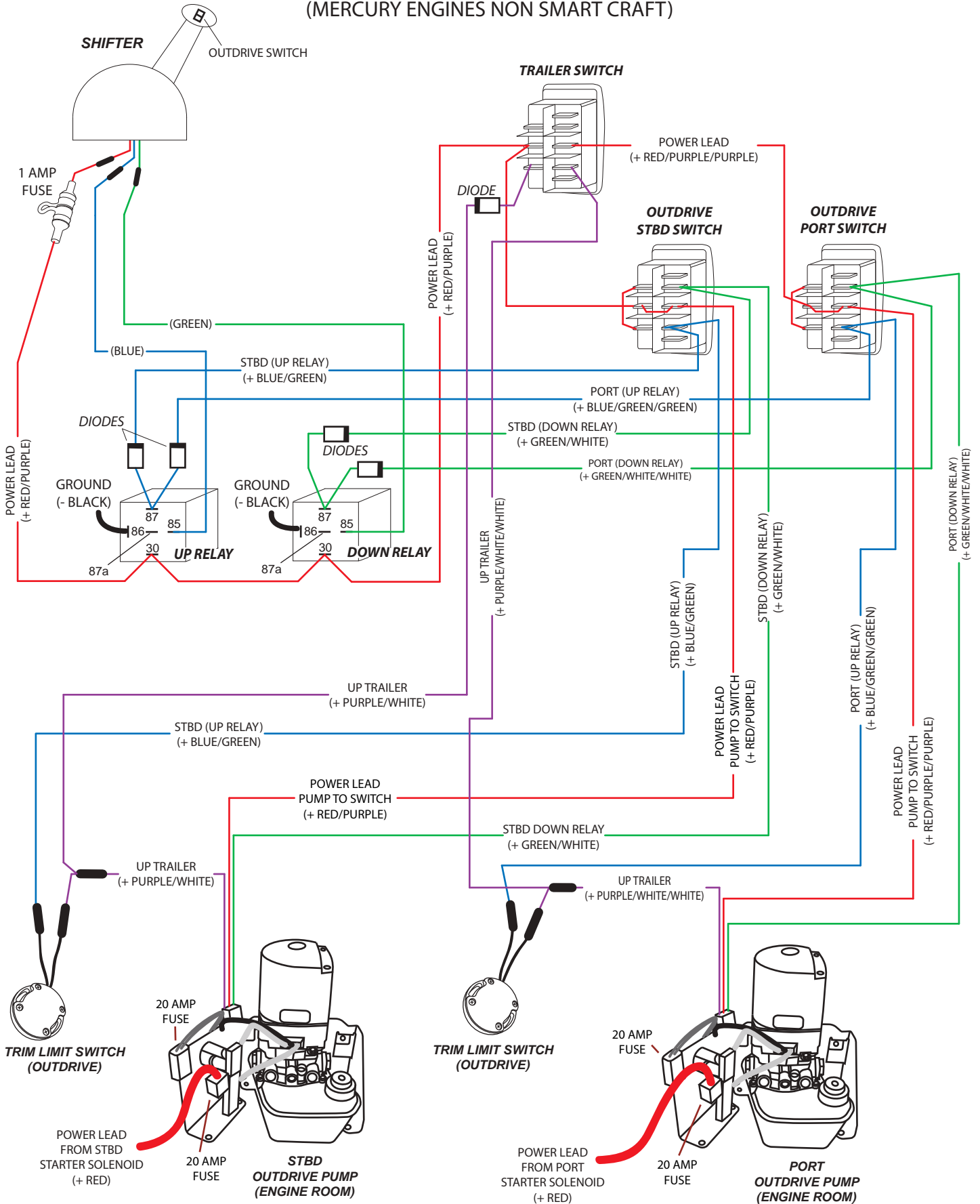

# SEAKEY

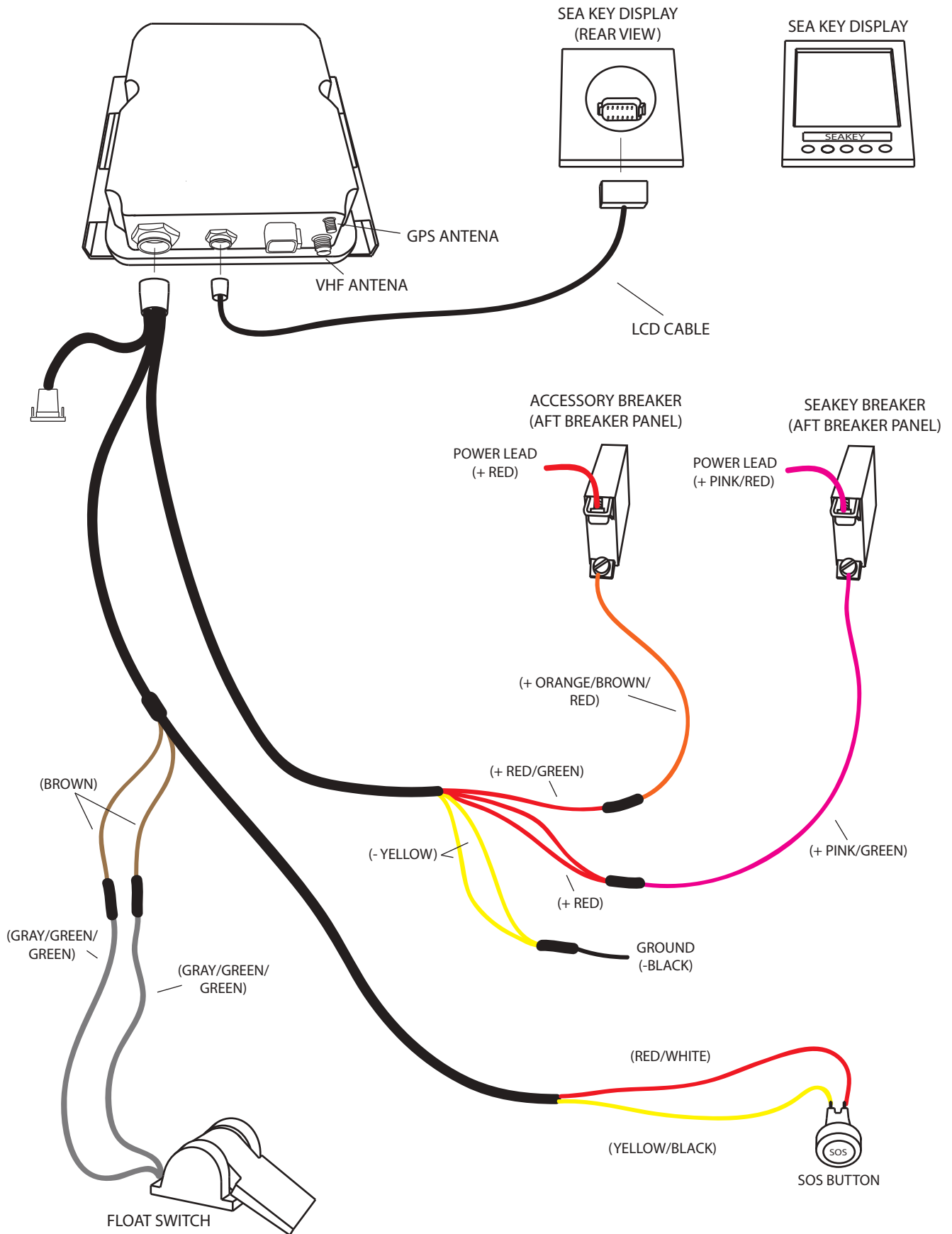



# SHOWER SUMP

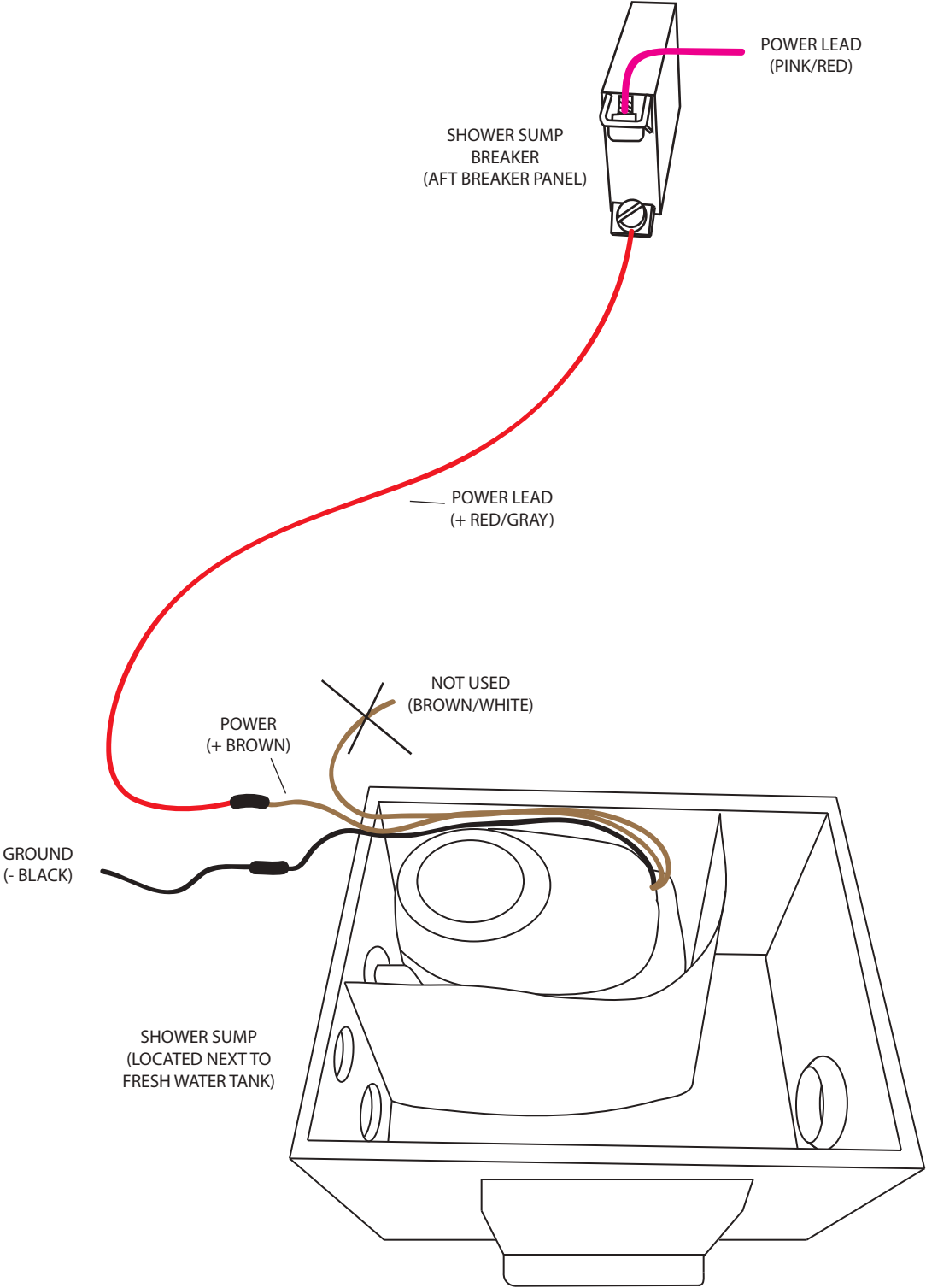

# SPOTLIGHT

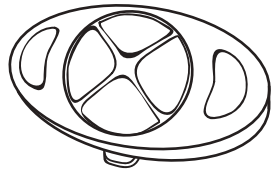

SPOTLIGHT REMOTE  
(WIRELESS TRANSMITTER)  
(LOCATED ON  
IGNITION PANEL)

POWER LEAD  
(+ RED)

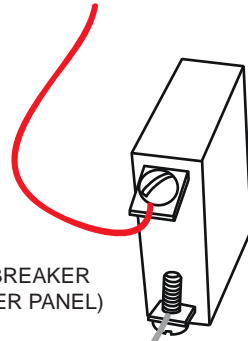

SPOTLIGHT BREAKER  
(DASH BREAKER PANEL)

SPOTLIGHT  
(RECEIVER)  
(LOCATED ON BOW  
OF BOAT)

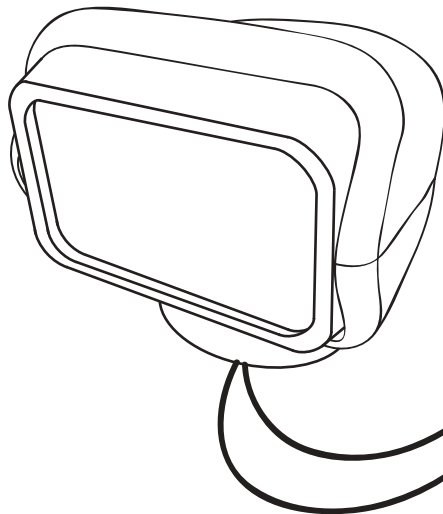

POWER LEAD  
(+ GRAY/ORANGE)

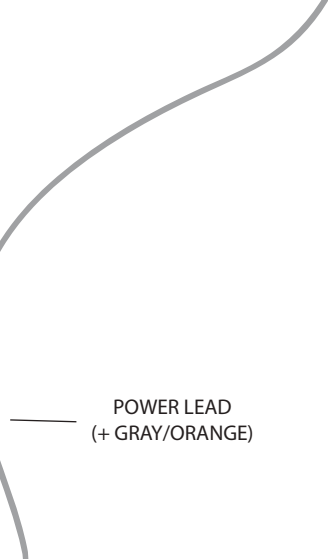

GROUND  
(- BLACK)

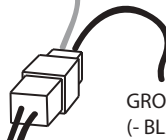

# START SOLENOID

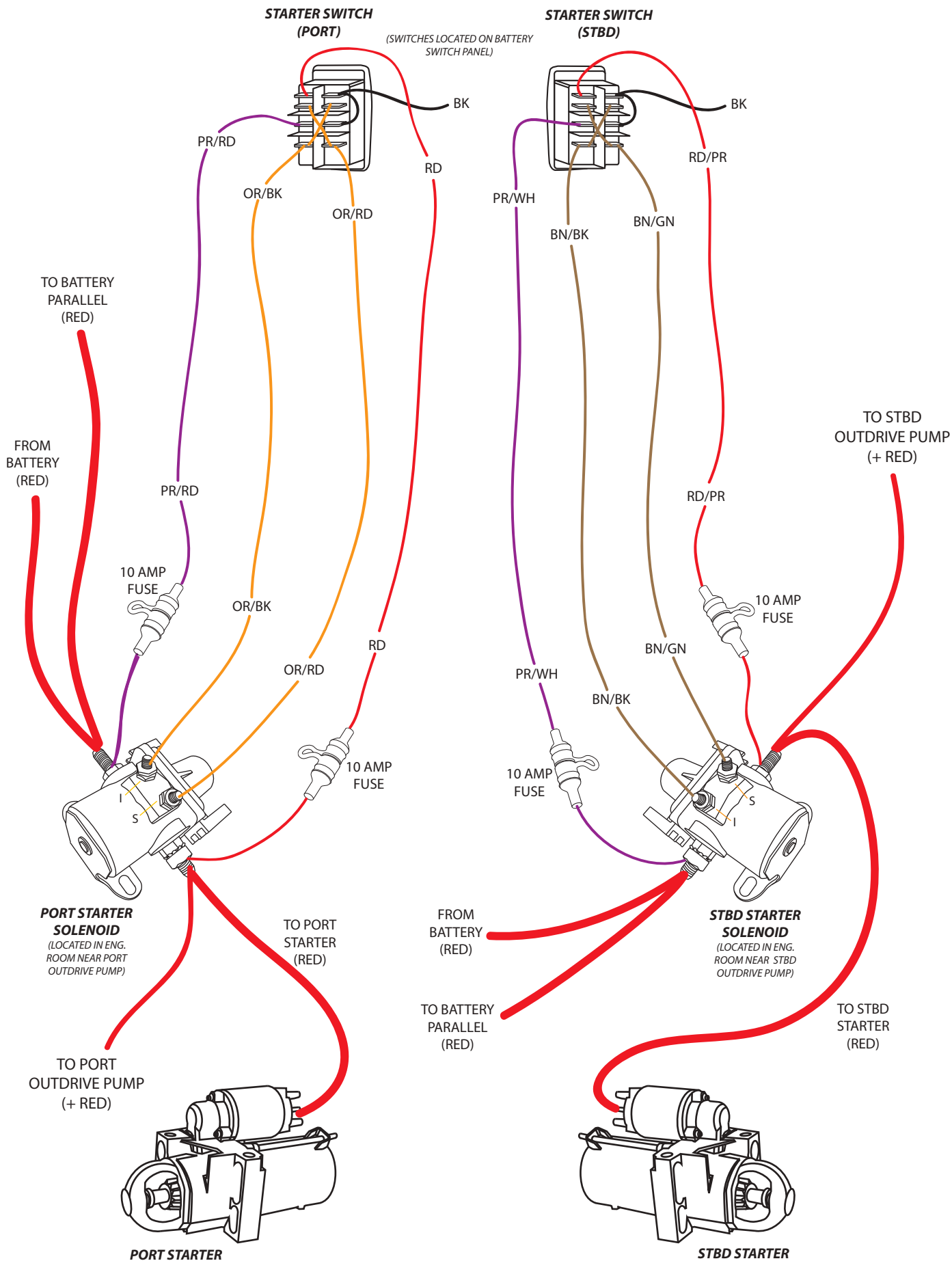

# STEREO KENWOOD KTS MP400MR

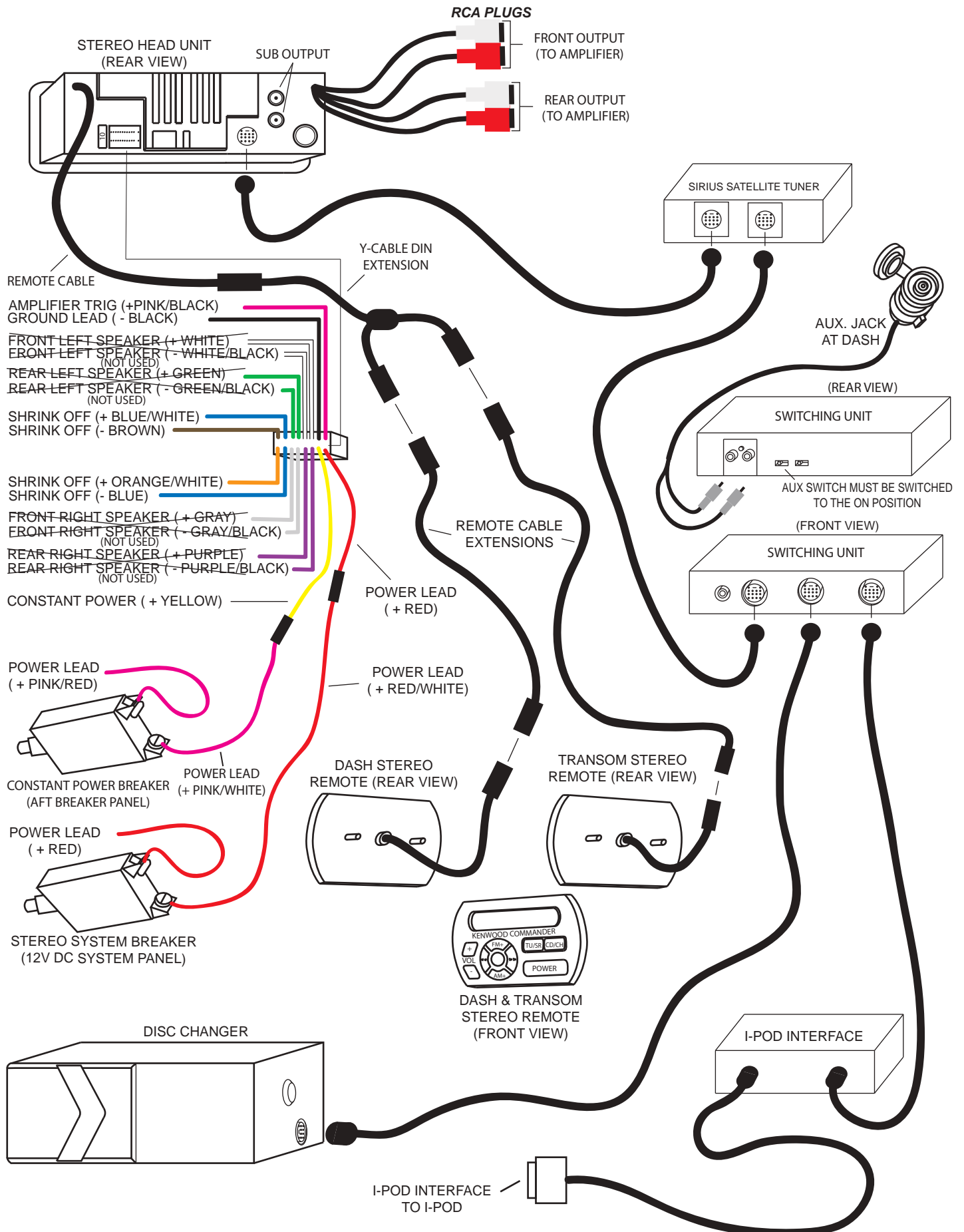

# STEREO SYSTEM

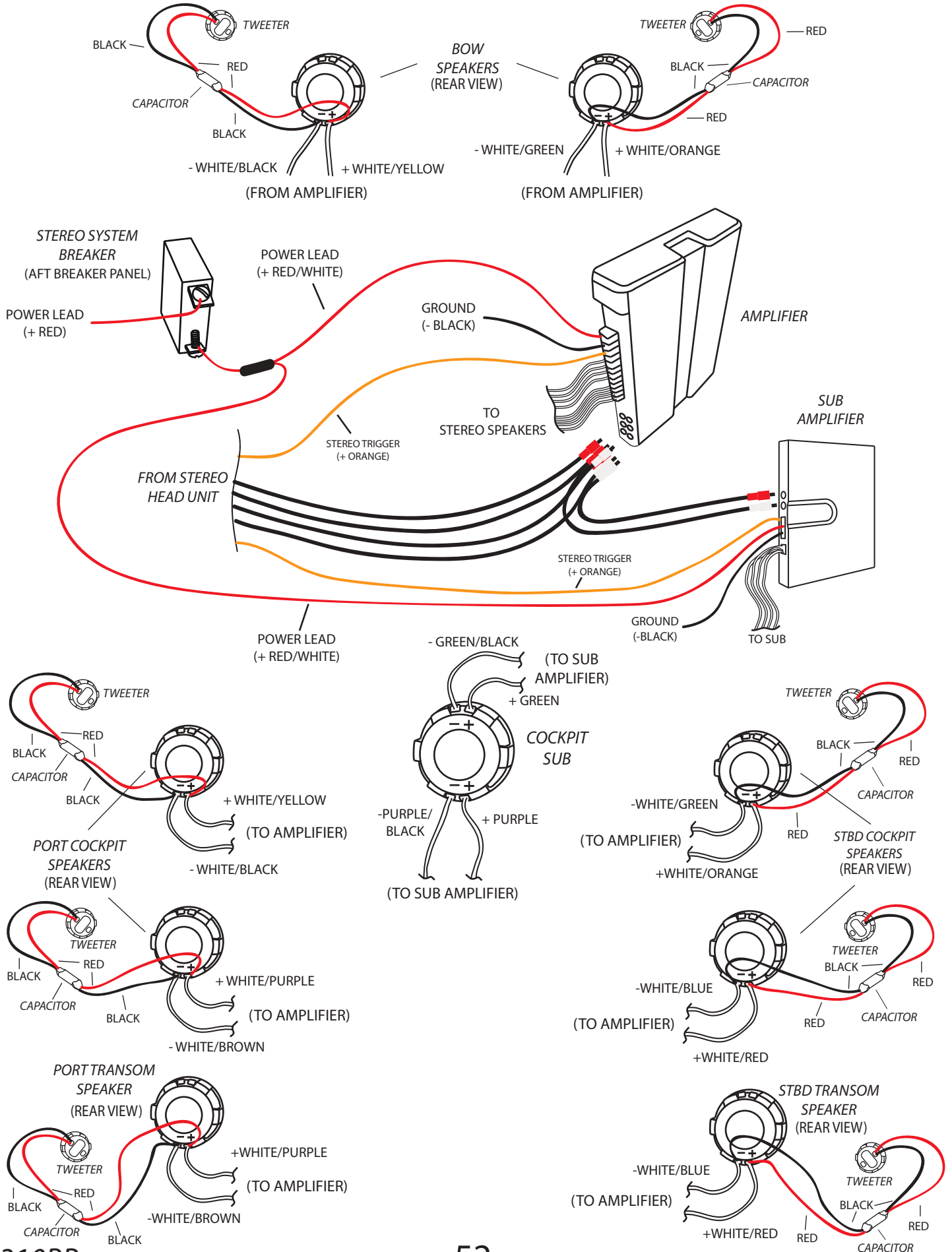

# TRIM TAB PUMP

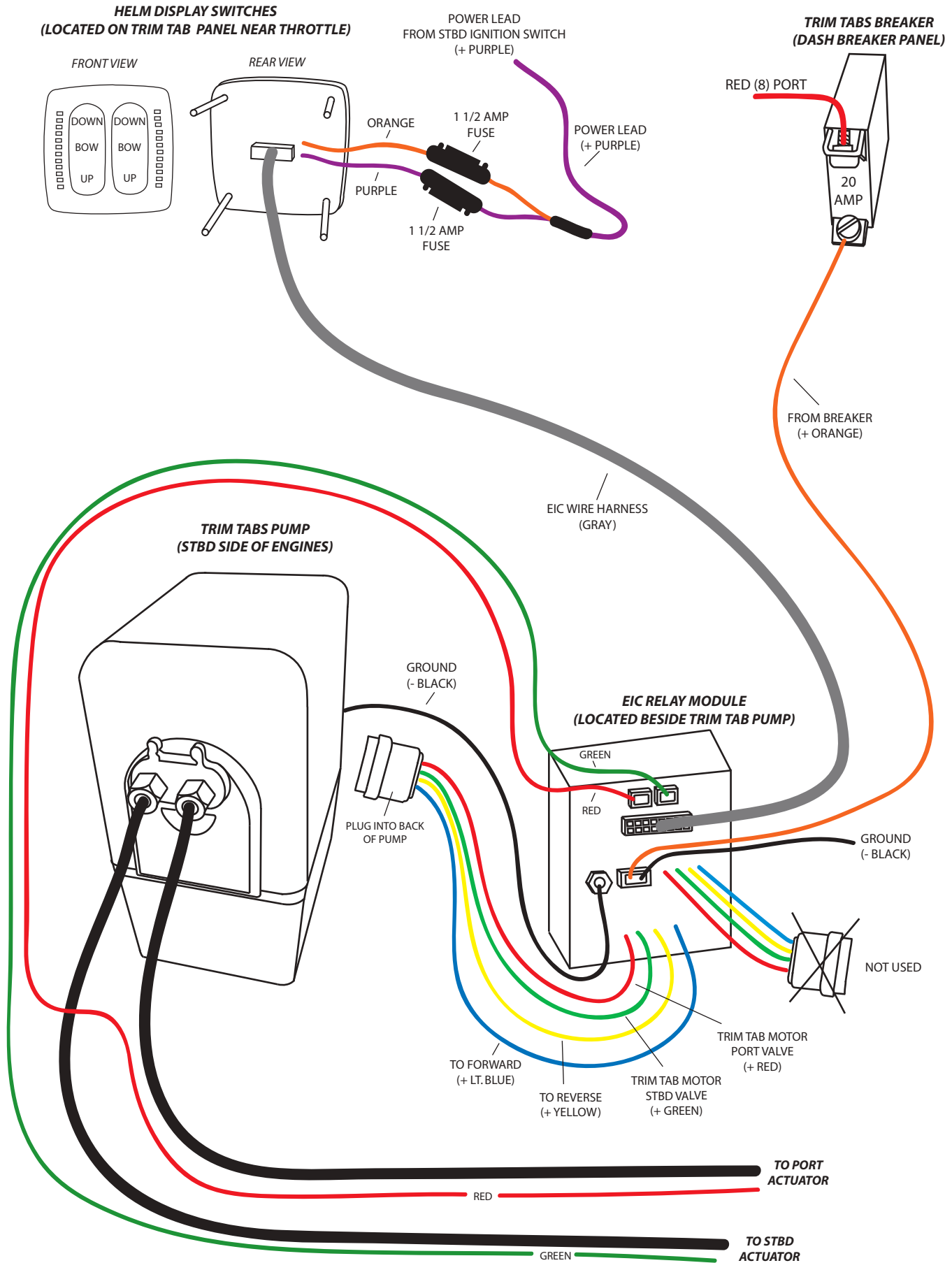

# VHF RADIO

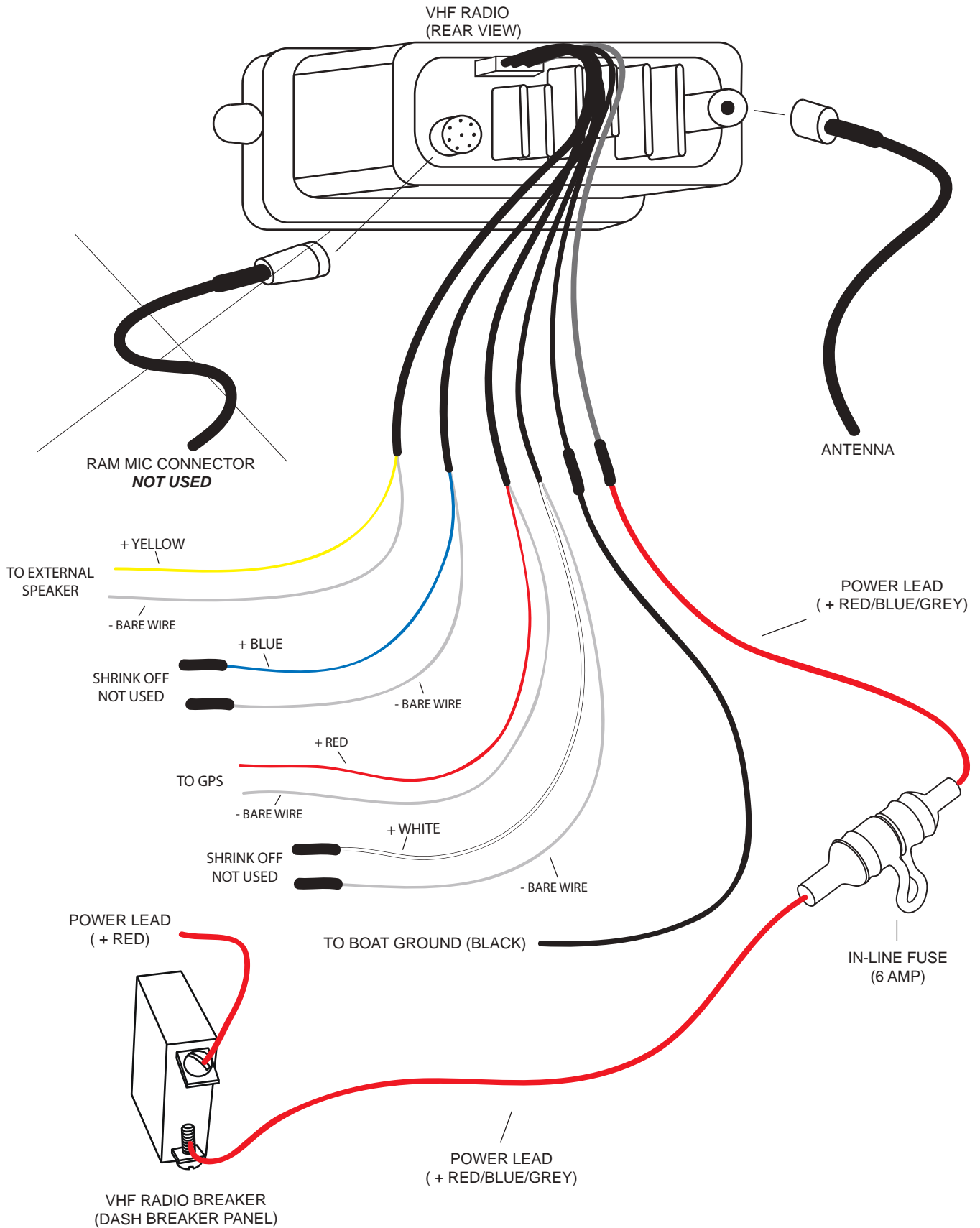

# WASTE SYSTEM

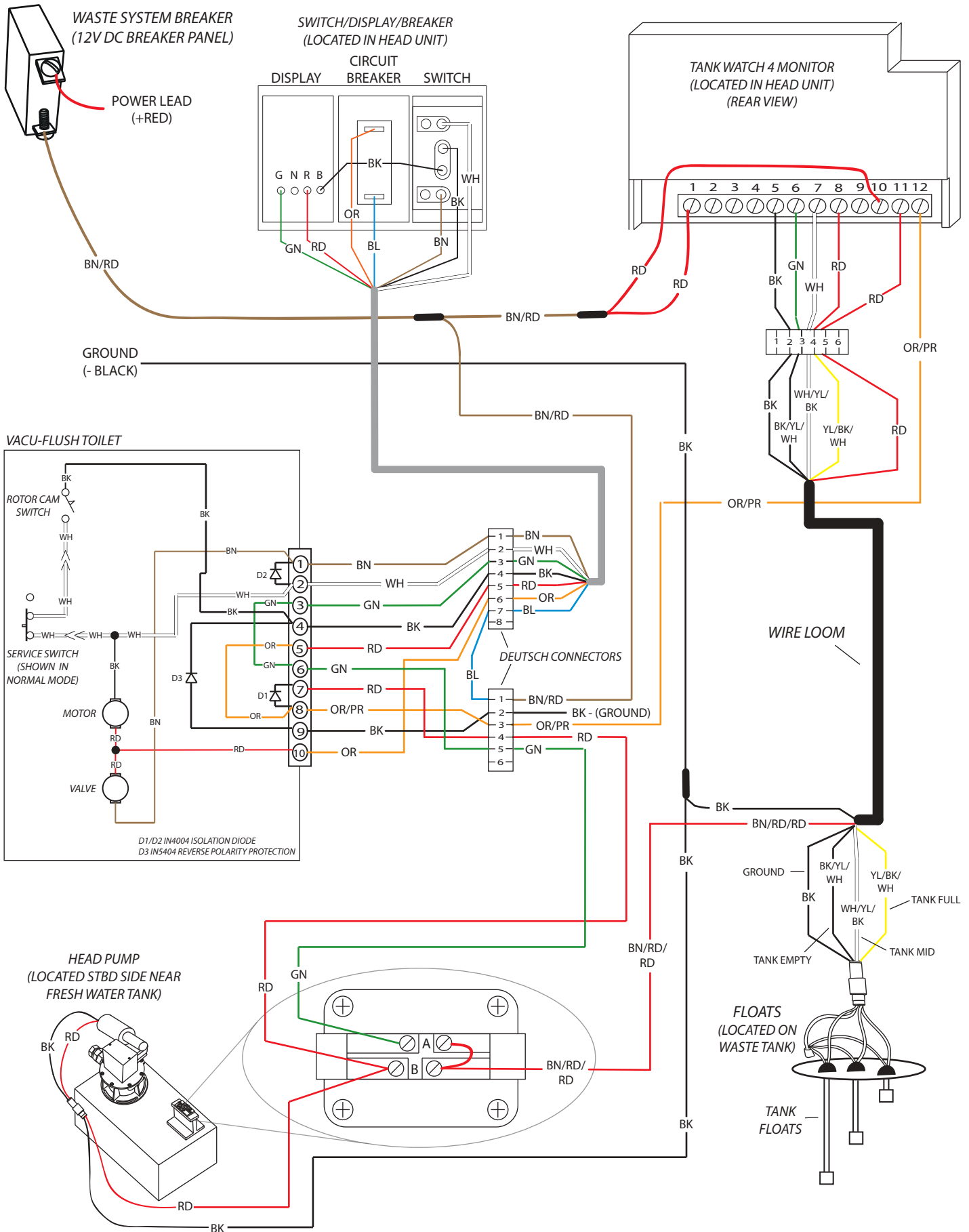



# WATER PUMP

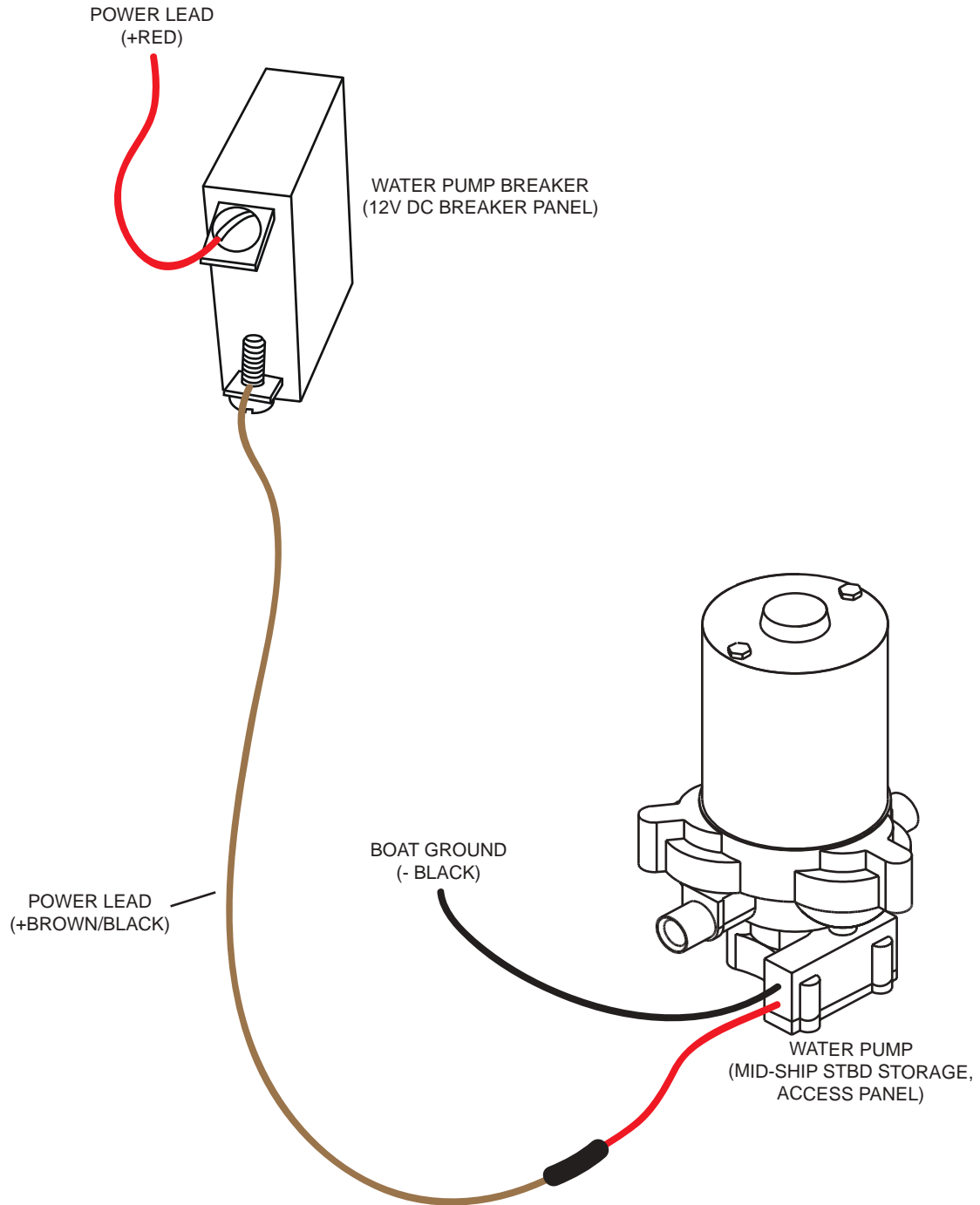

# WINDLASS

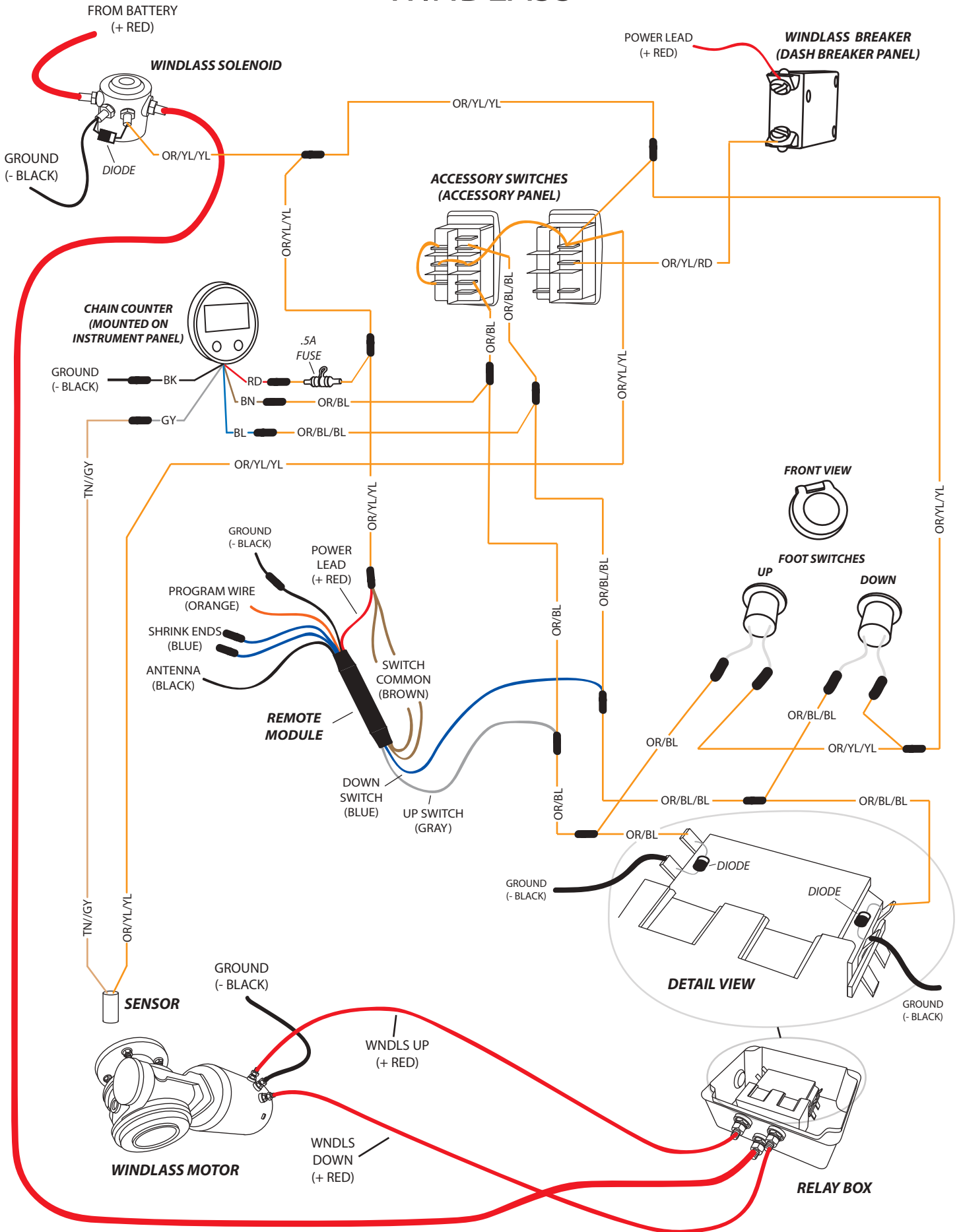

# WIPER

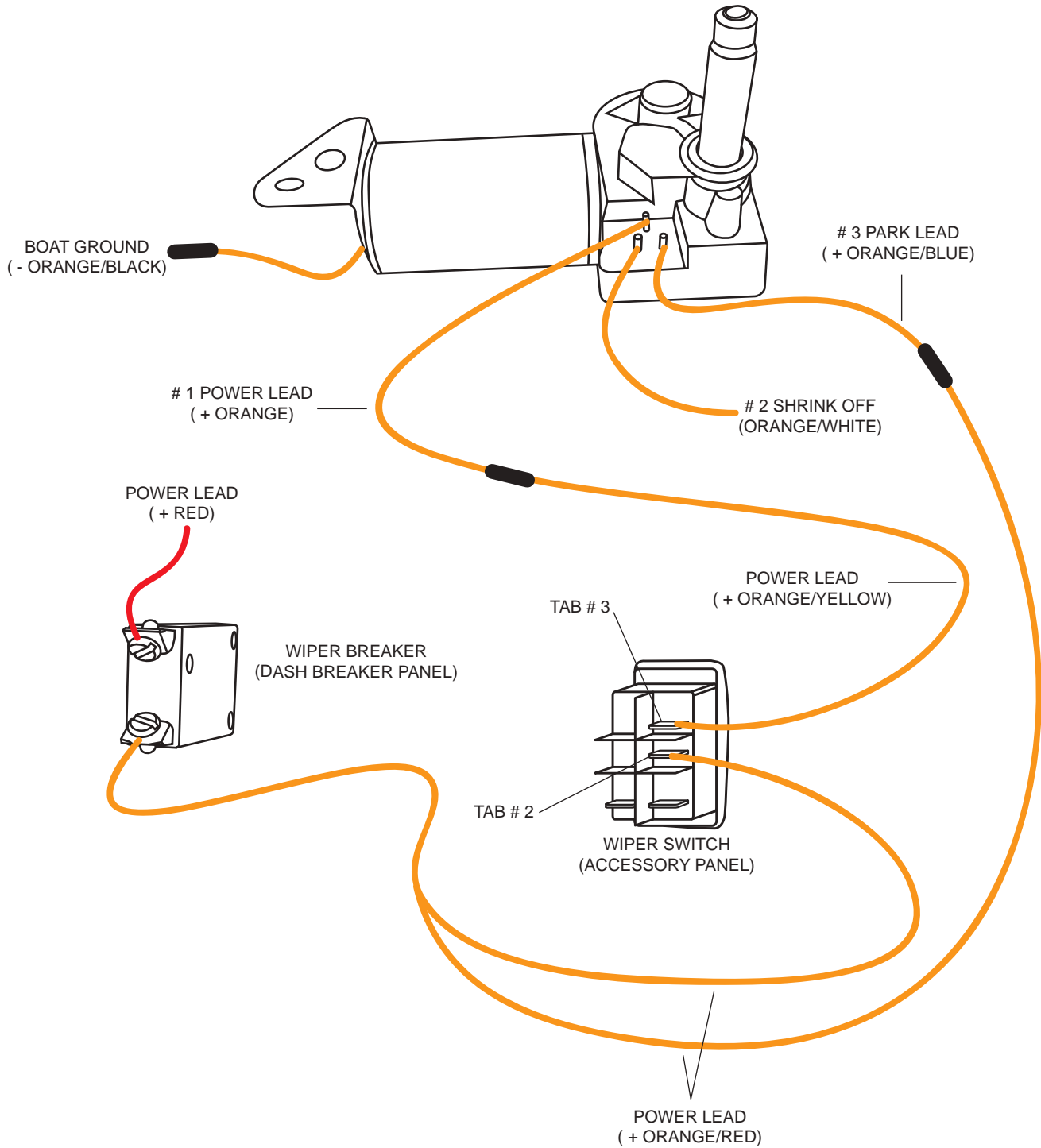

# HEAD PUMP PLUMBING

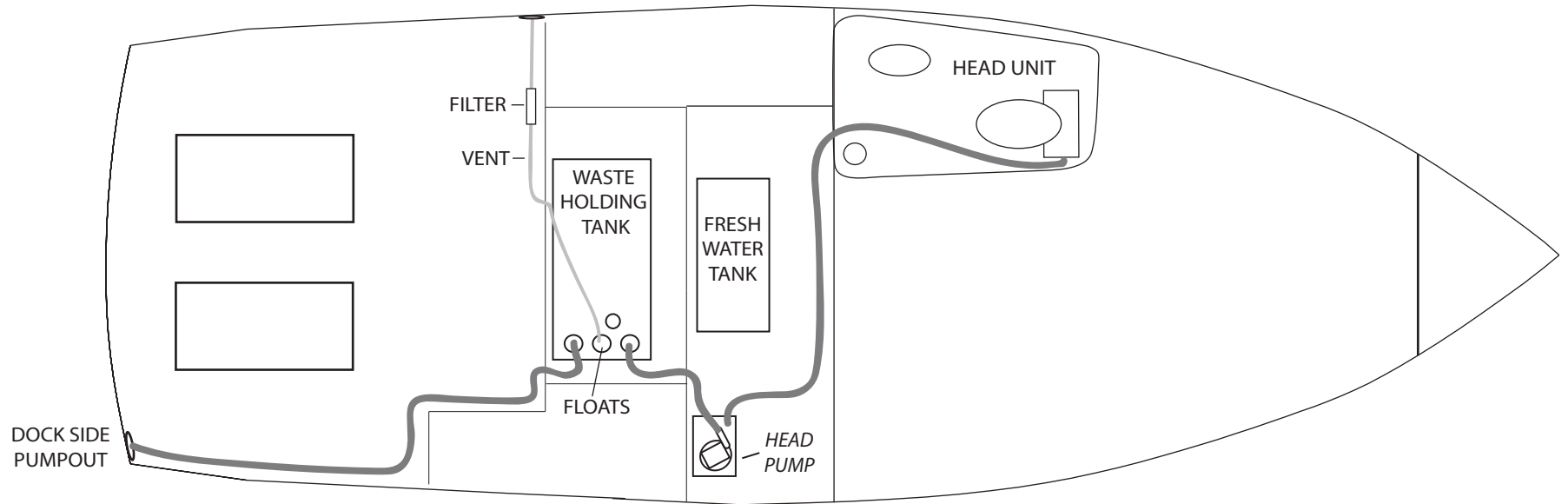

59

# HEAD PUMP/MACERATOR PLUMBING

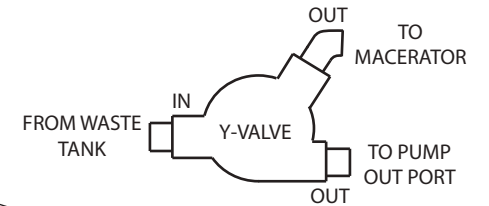
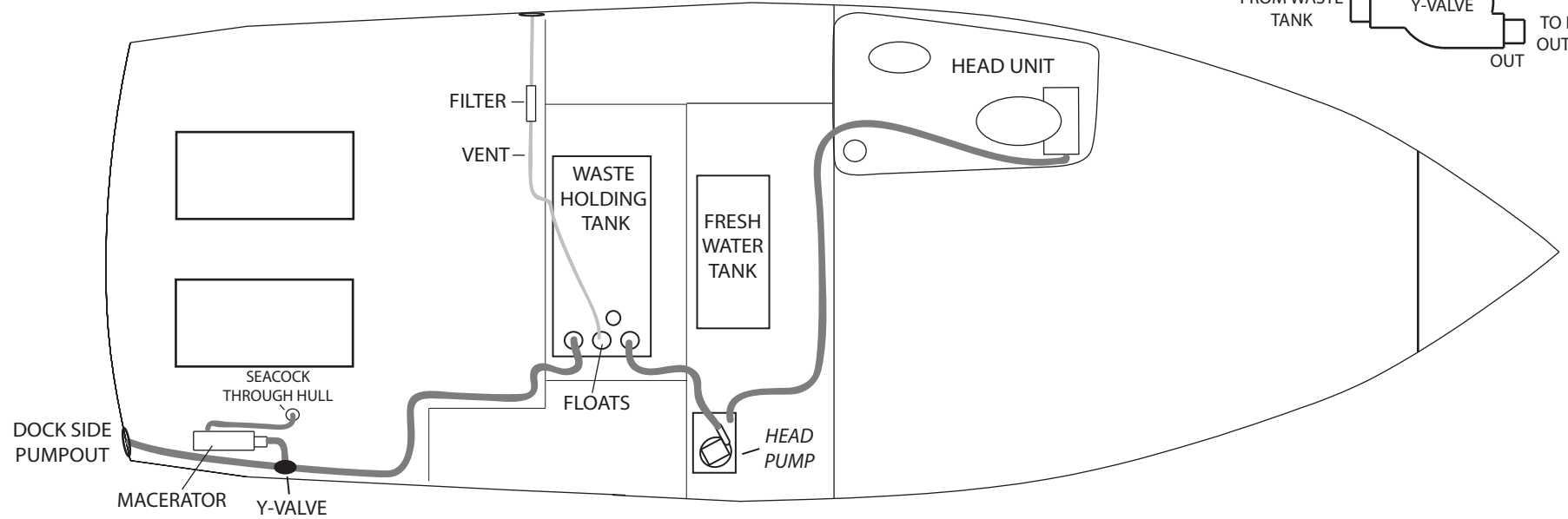

310BR

# SHOWER SUMP PLUMBING

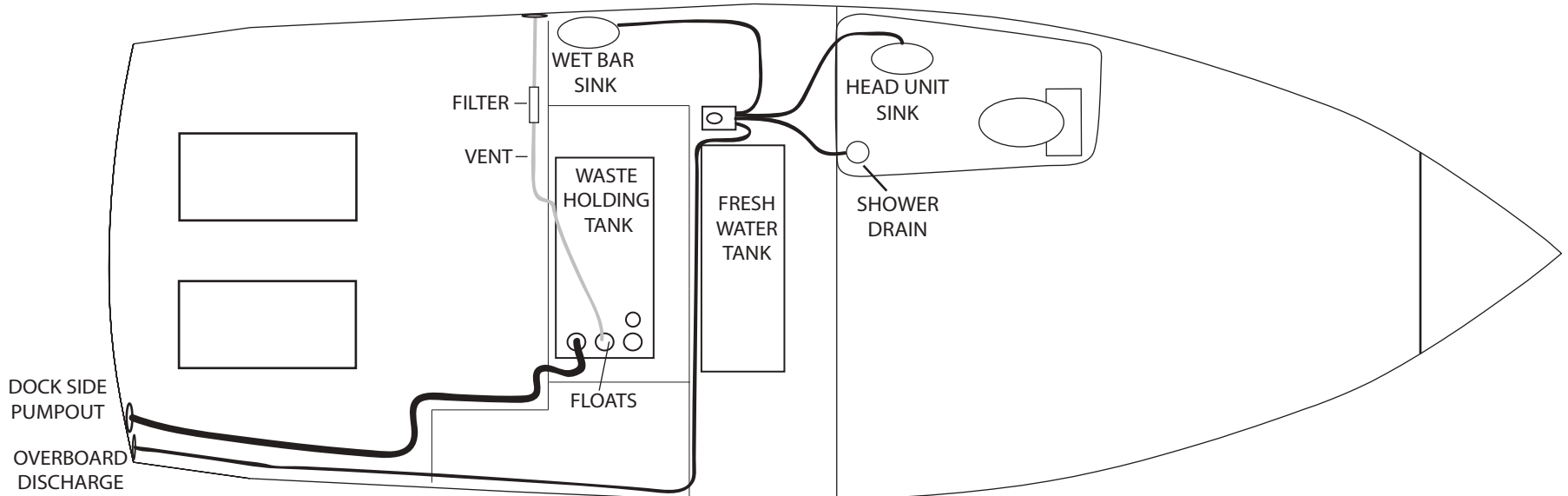

STANDARD BOAT

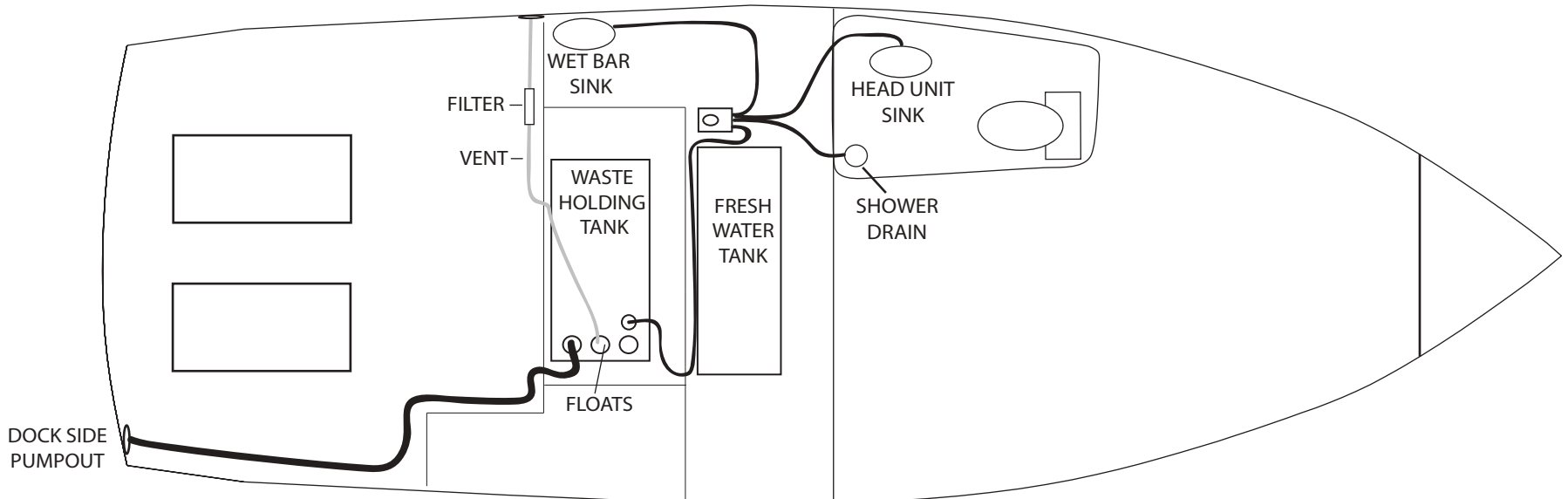



GRAY WATER OPTION

# WATER SYSTEM

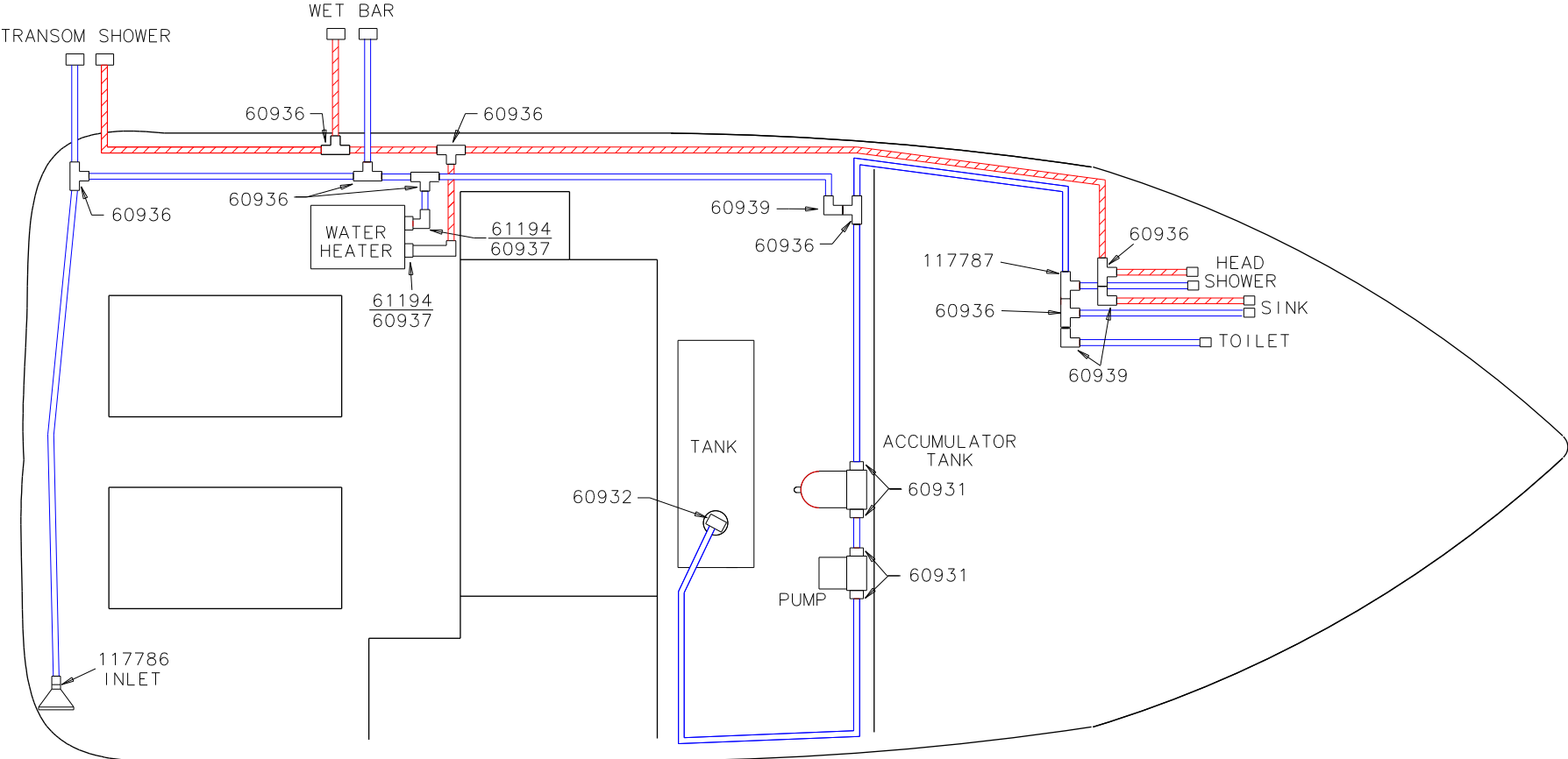
61



310BR

LEGEND	
ALL 15mm WATER LINE	
	HOT
	COLD

# FUEL SYSTEM

