

THUNDERBIRD PRODUCTS

#49238

FIRST EDITION 2007

Because of the Formula commitment to product quality and innovation, we reserve the right, at any time, to discontinue or change specifications, design, or features without incurring obligation. Thunderbird Products is not responsible for any technical issues that may arise due to the use of obsolete drawings.

<https://www.boat-manuals.com/>

CONTENTS

TABLE OF CONTENTS	1	FUME DETECTOR	35
TABLE OF CONTENTS	2	GPS	45
HARNESSES AND PIGTAIL #'S	3	HEAD BLOWER	36
WIRING HARNESS LAYOUT	4	HELM VIEW	38
WIRING HARNESS LAYOUT	5	HIGH WATER ALARM	39
<u>AC CIRCUITS</u>		HORN	40
120v AC SYSTEM PANEL	16	IGNITION PANEL	9
AC OUTLETS	17	IGNITION SYSTEM	41
BATTERY CHARGER (AC CURRENT)	18	LIGHTS	
COCKPIT REFRIGERATOR	19	ANCHOR LIGHTS.	22
WATER HEATER	20	CABINET LIGHT	25
<u>DC CIRCUITS</u>		COURTESY LIGHTS	29
12v DC SYSTEM PANEL	15	DOCKING LIGHTS	32
AFT BREAKER PANEL	7	HEAD LIGHT	37
BATTERY PARALLEL / BATT. CHGR	21	NAVIGATION LIGHTS.	44
BILGE BLOWERS	22	SPOTLIGHT	49
CABIN BILGE PUMP	23	MACERATOR	42
ENGINE BILGE PUMP	24	MERCATHODE	43
CAPTAIN'S CALL (PORT)	26	NAVIGATION SYSTEM	45
CAPTAIN'S CALL (STBD)	27	OUTDRIVE PUMP	46
CO DETECTOR	28	SEAKEY	47
DASH BREAKER PANEL	8	SHOWER SUMP	48
DASH OUTLET	30	STARTER SOLENOID	50
DEPTH SOUNDER	31	STEREO	51
ENGINE HATCH	33	STEREO SYSTEM	52
FIRE EXTINGUISHER	34	TRIM TAB PUMP	53
		VHF RADIO	54
		WASTE SYSTEM	55
		WATER PUMP	56
		WINDLASS	57

CONTENTS

DC CIRCUITS

WIPER 58

PANELS

ACCESSORY PANEL 6

AFT BREAKER PANEL 7

BATTERY SWITCH PANEL 21

DASH BREAKER PANEL 8

IGNITION PANEL 9

INSTRUMENT PANEL (BASE/GPS) 10

INSTRUMENT PANEL (CHART) 11

INSTRUMENT PANEL (DTS) 12

TRIM TAB PANEL 13

TRIM TAB PANEL (DTS) 14

12v DC SYSTEM PANEL 15

120v AC SYSTEM PANEL 16

PLUMBING

HEAD PUMP 59

MACERATOR 59

SHOWER SUMP 60

WATER SYSTEM DIAGRAM 61

FUEL SYSTEM

FUEL SYSTEM 62

HARNESS & PIGTAIL #'S

HARNESSES

DECK	45993
HULL	45994
110V AC	46995
220V AC	46996

PIGTAILS

ACCESSORY PANEL	47323
AC/DC PANEL	45037
AFT BREAKER PANEL	43891
ARCH	43880
DASH BREAKER PANEL	43883
ENGINE HATCH	43867
HEAD UNIT	45038
HELM SEAT	47327
IGNITION PANEL	44708
MAIN INSTRUMENT PANEL	43882
TRIM TAB	43892
WINDLASS	47332

LEGEND

WIRE IDENTIFICATION			
WIRE COLOR	STRIPE	STRIPE	ABBREVIATION
YELLOW	BROWN	RED	YL/BN/RD

WIRE COLOR SYMBOLS	
RED	RD
ORANGE	OR
YELLOW	YL
GREEN	GN
BLUE	BL
LIGHT BLUE	LT BL
PURPLE	PR
PINK	PK
BROWN	BN
BLACK	BK
WHITE	WH

LEGEND

DECK HARNESS ————

HULL HARNESS —————

HARNESS PLUG 

310 WIRING HARNESS LAYOUT

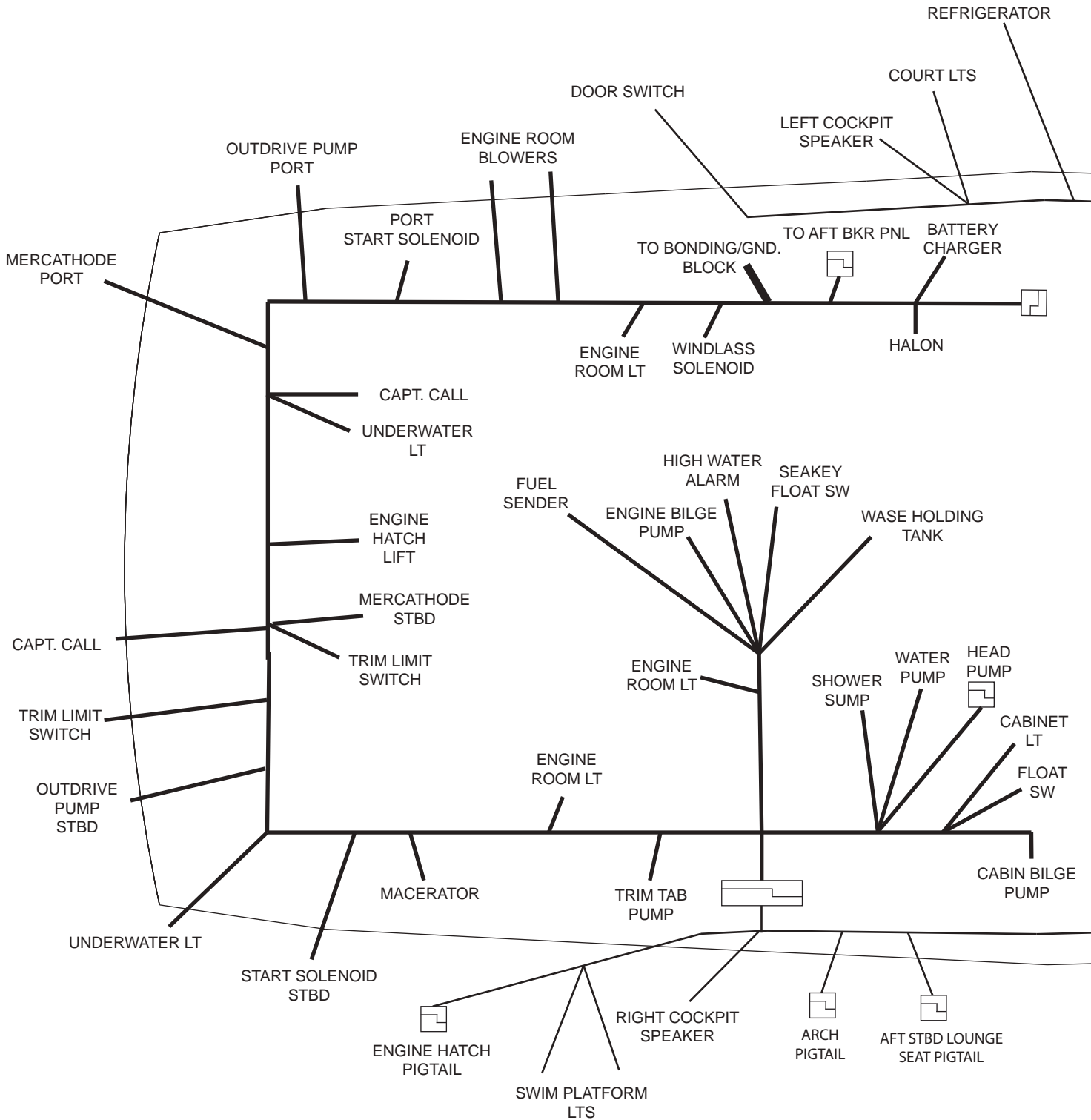

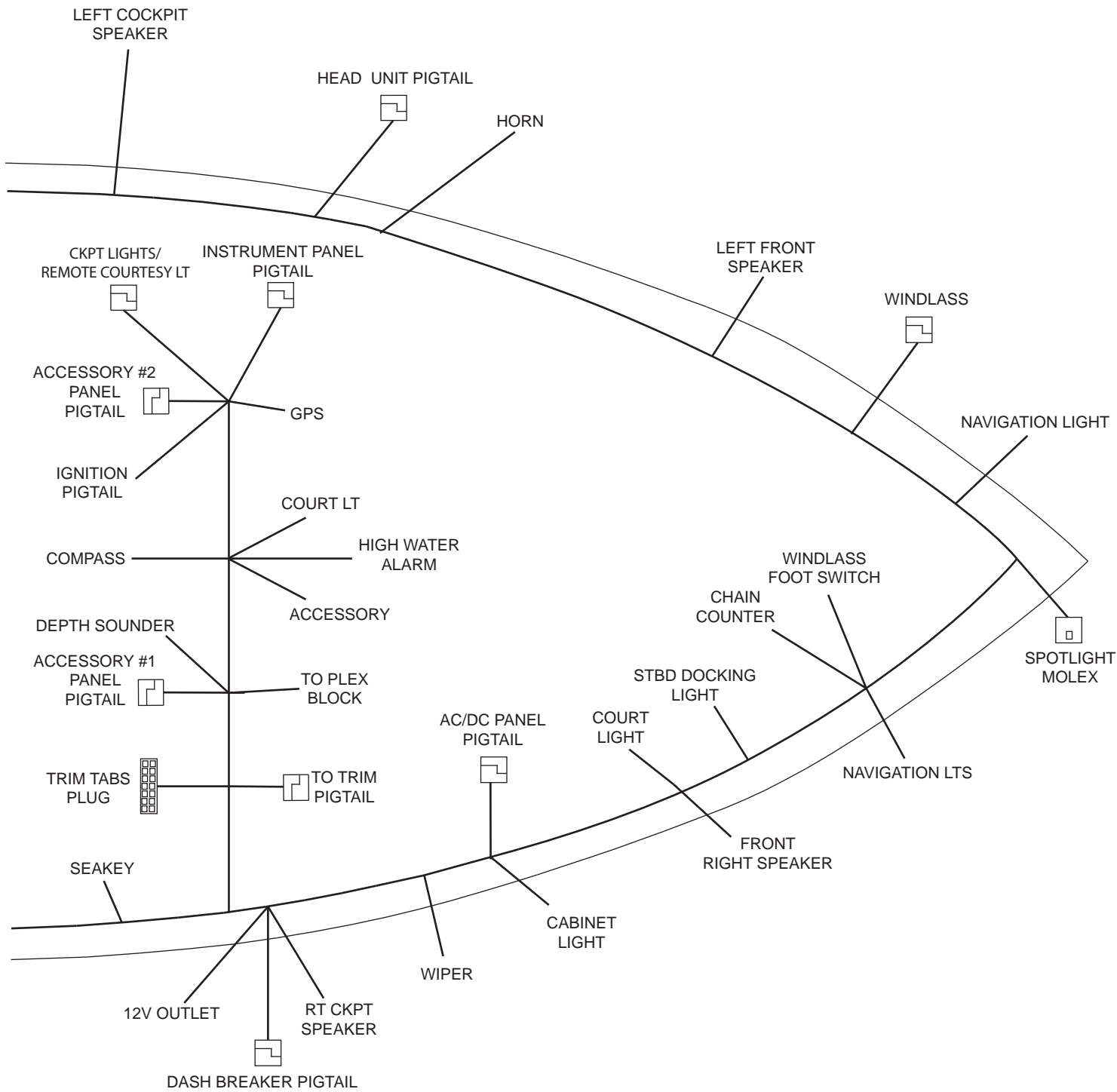

ACCESSORY PANEL

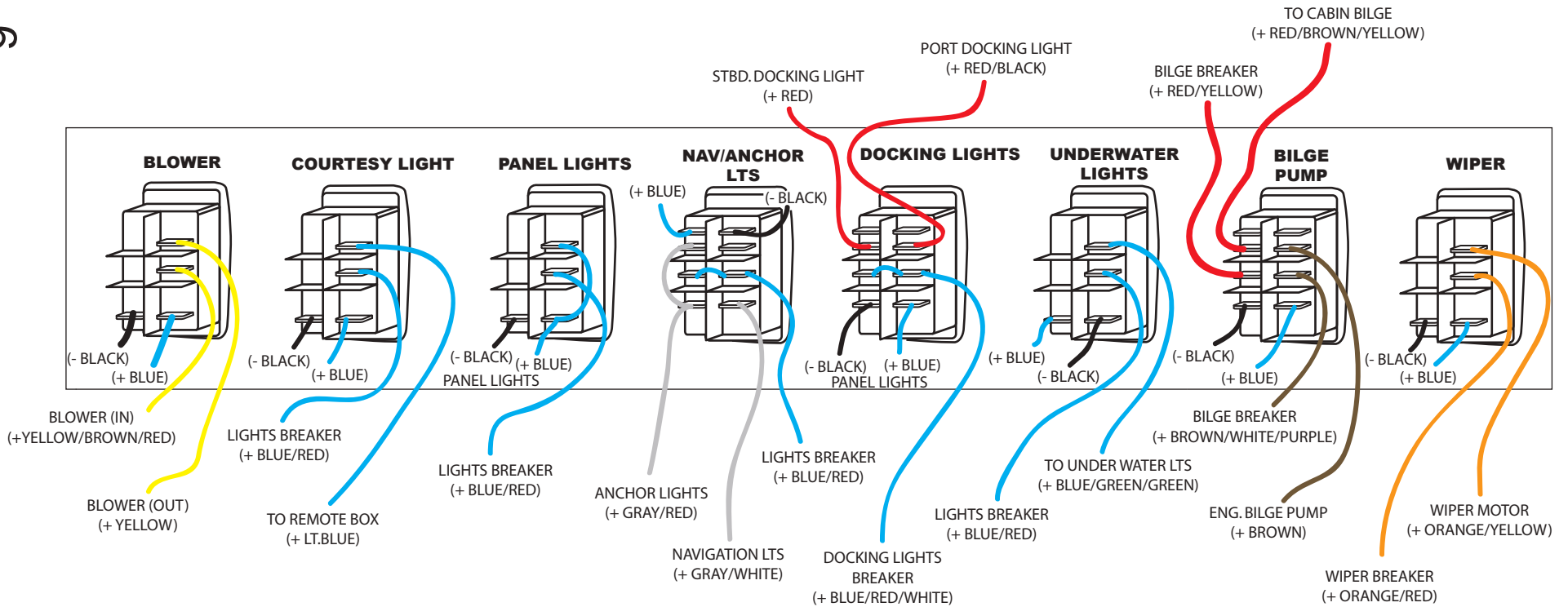
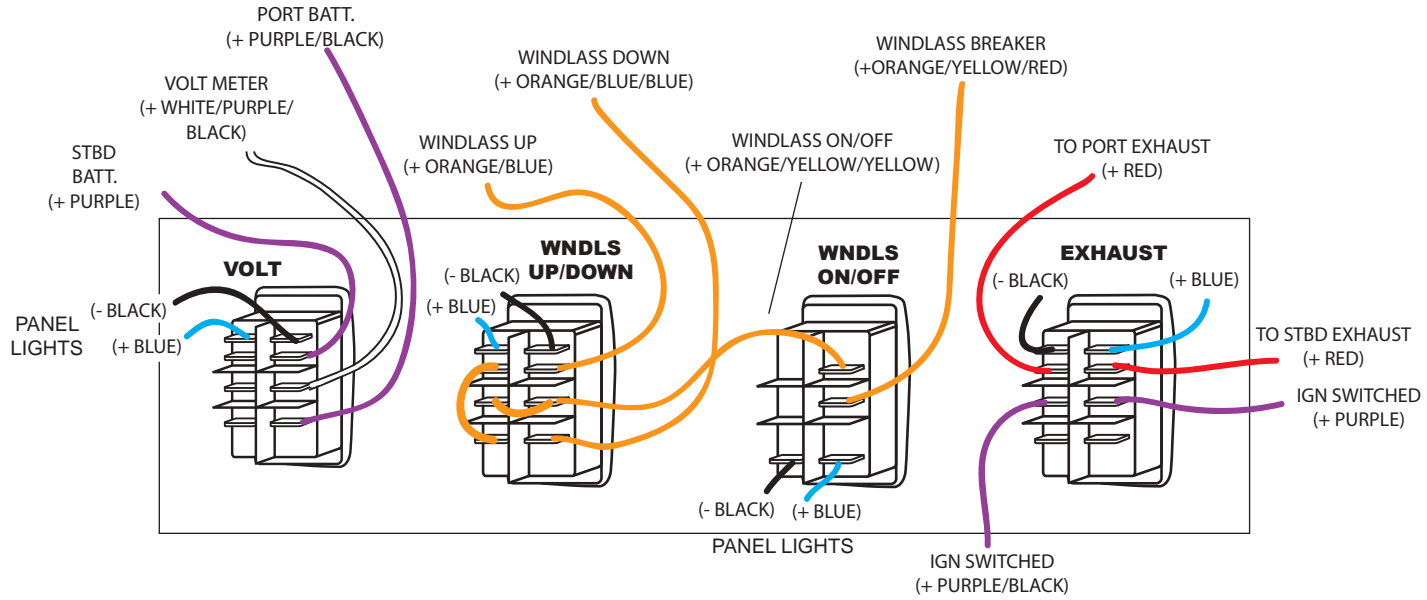

AFT BREAKER PANEL

(REAR VIEW)

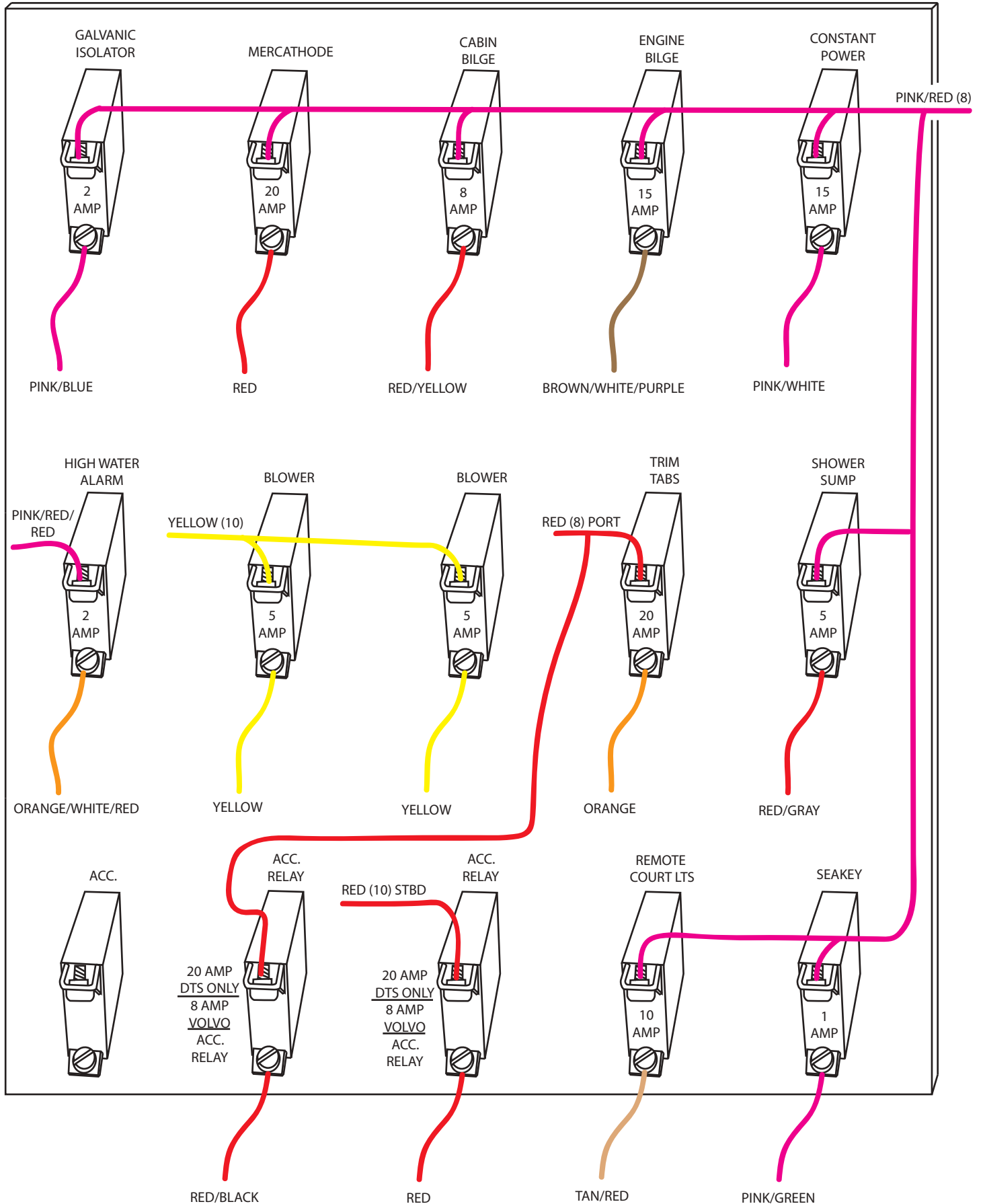

DASH BREAKER PANEL

(REAR VIEW)

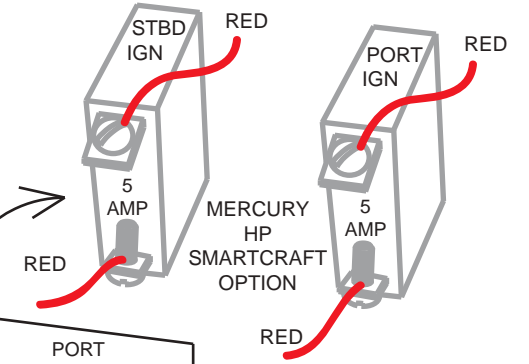
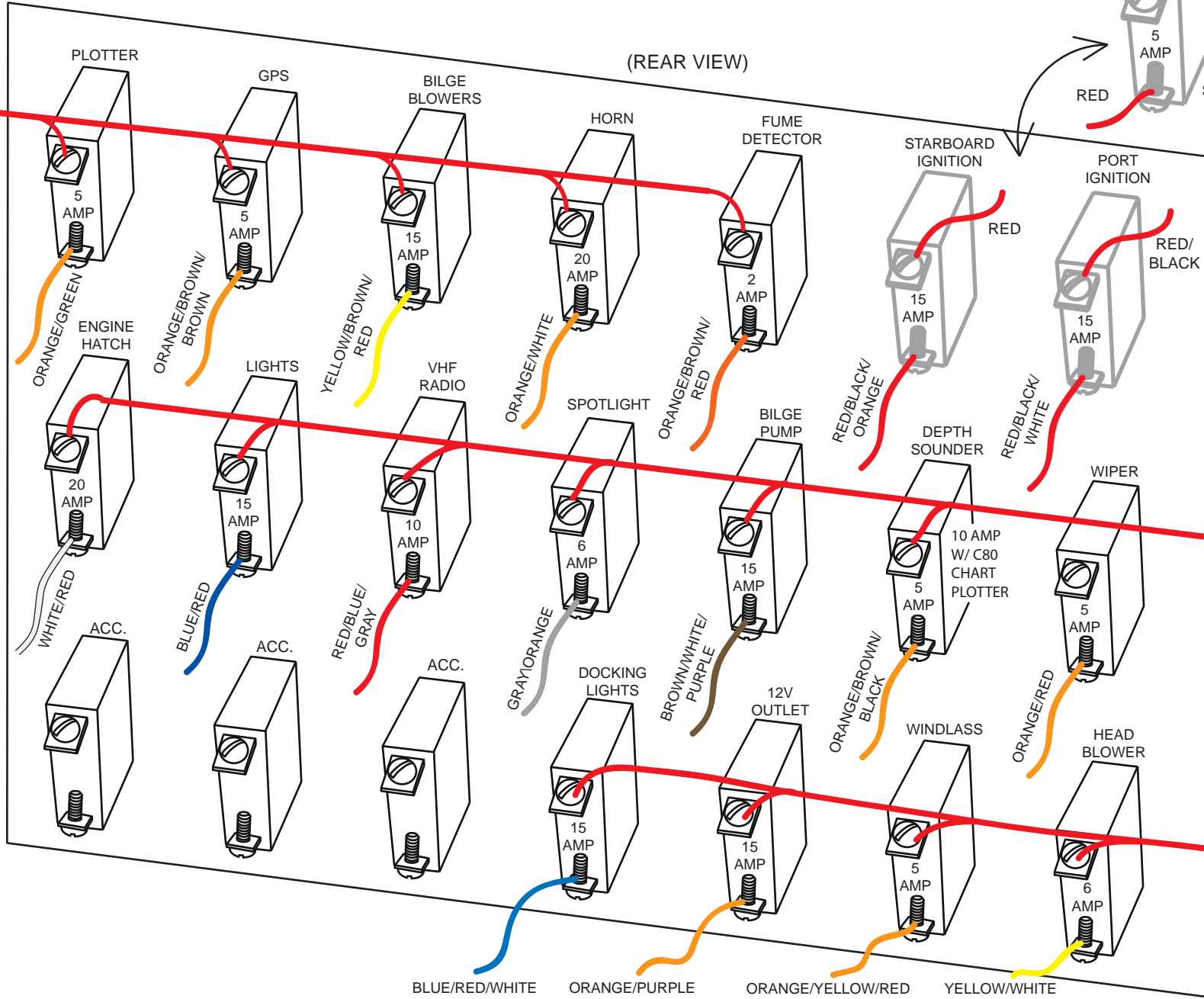

IGNITION PANEL

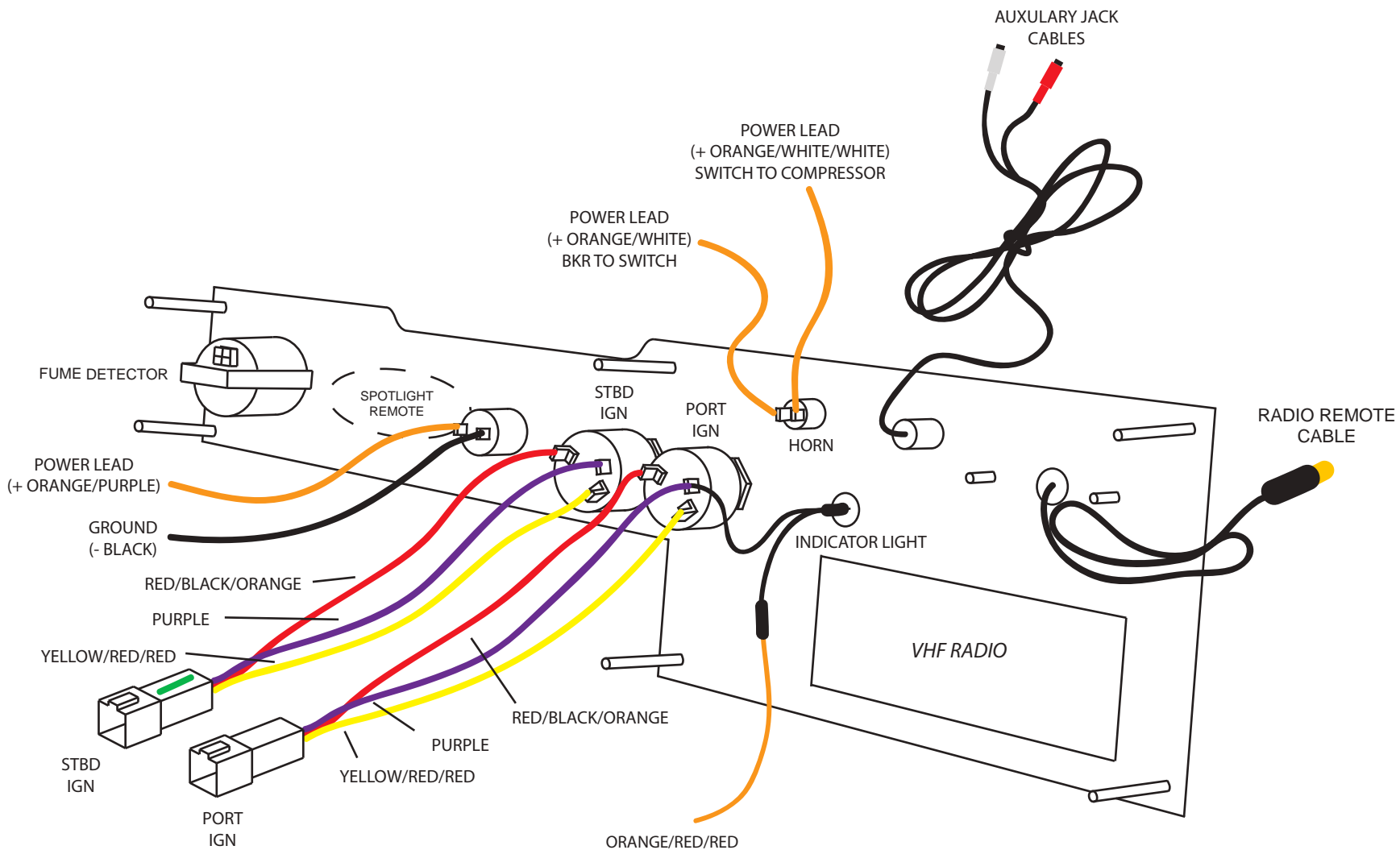

9

310BR

INSTRUMENT PANEL

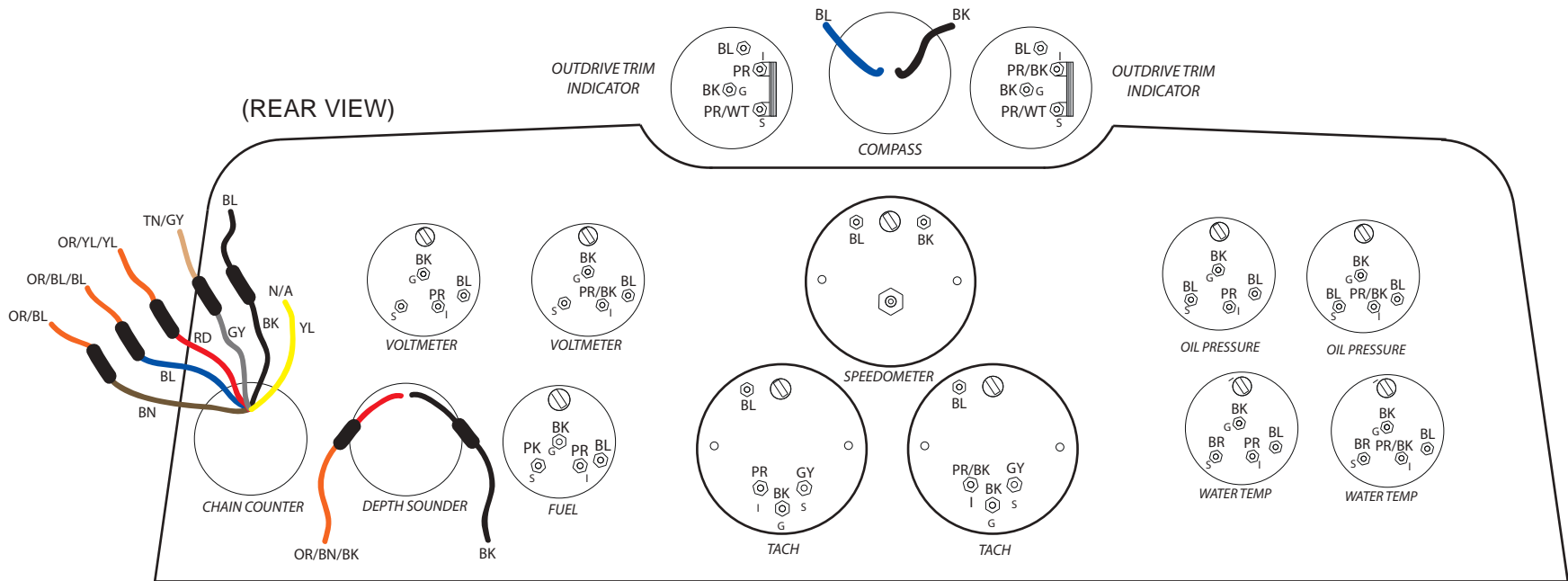

(GAUGES)

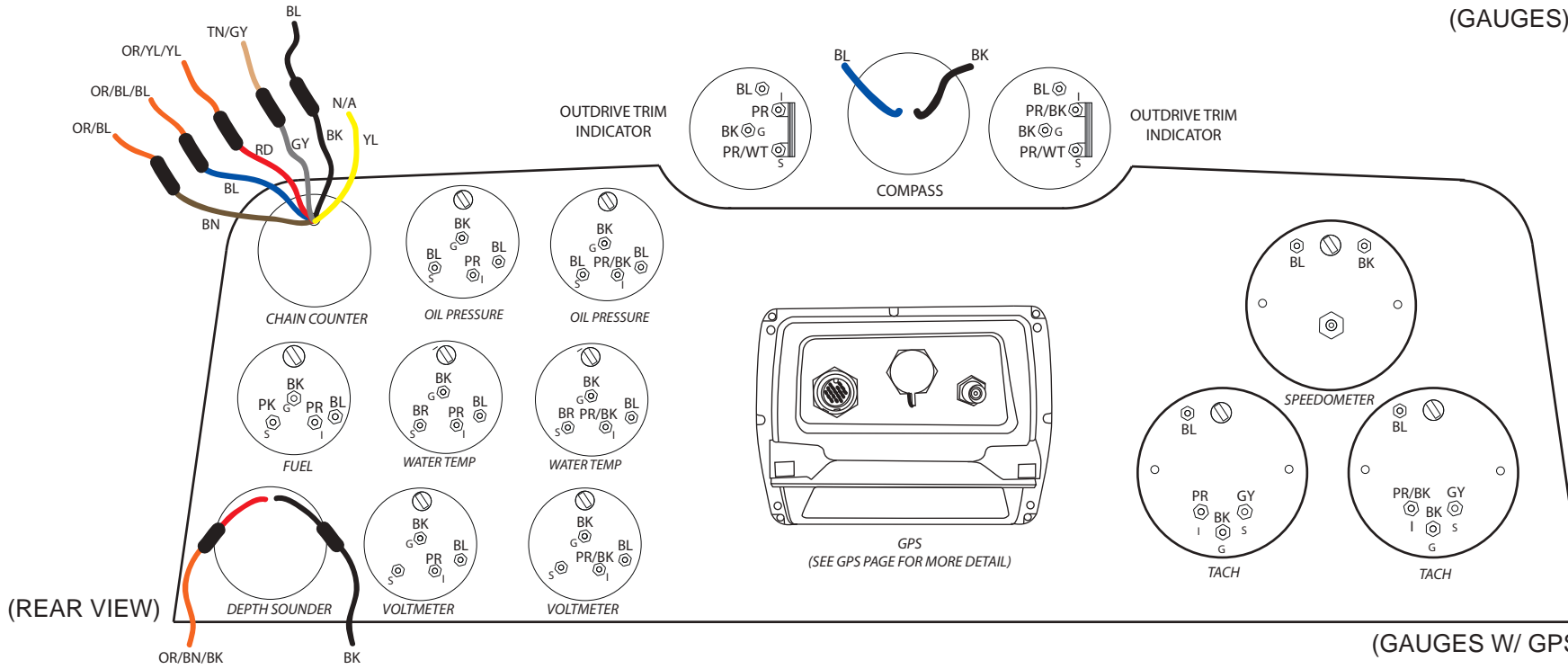

INSTRUMENT PANEL

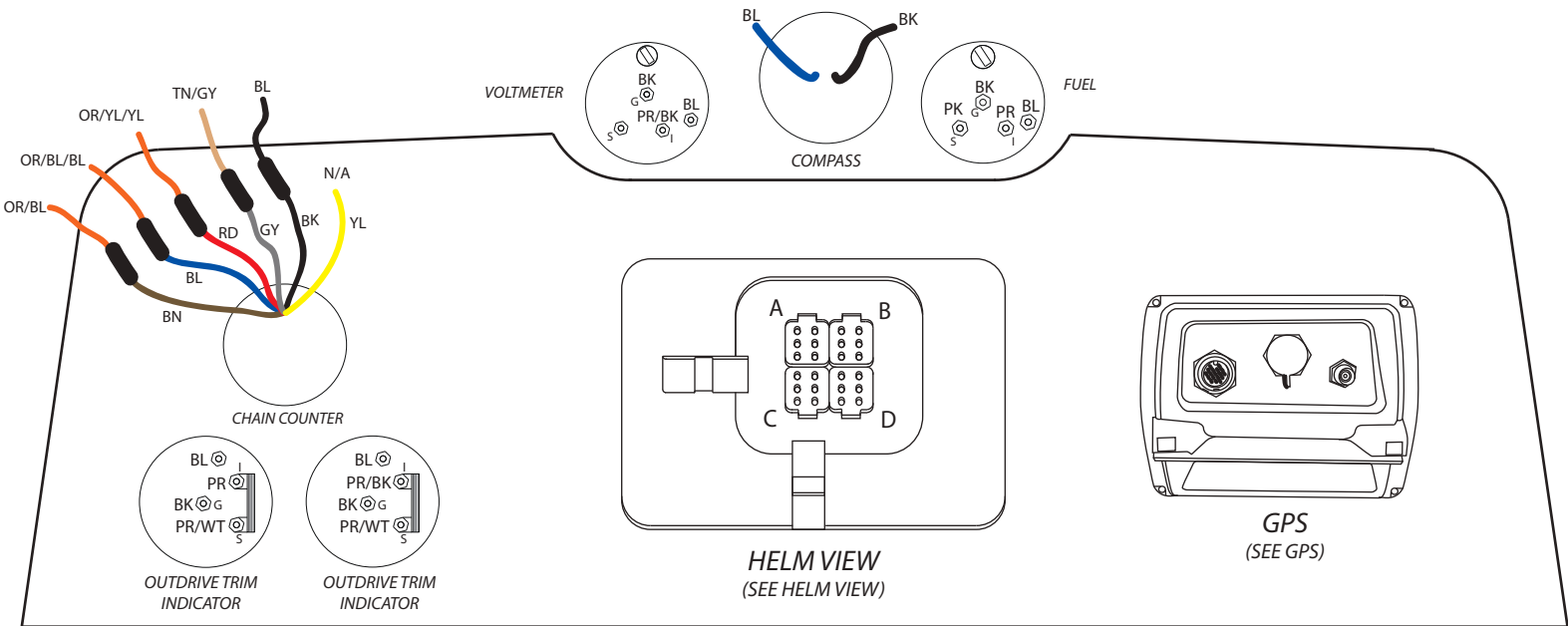

(REAR VIEW)

(HELM VIEW OPTION)

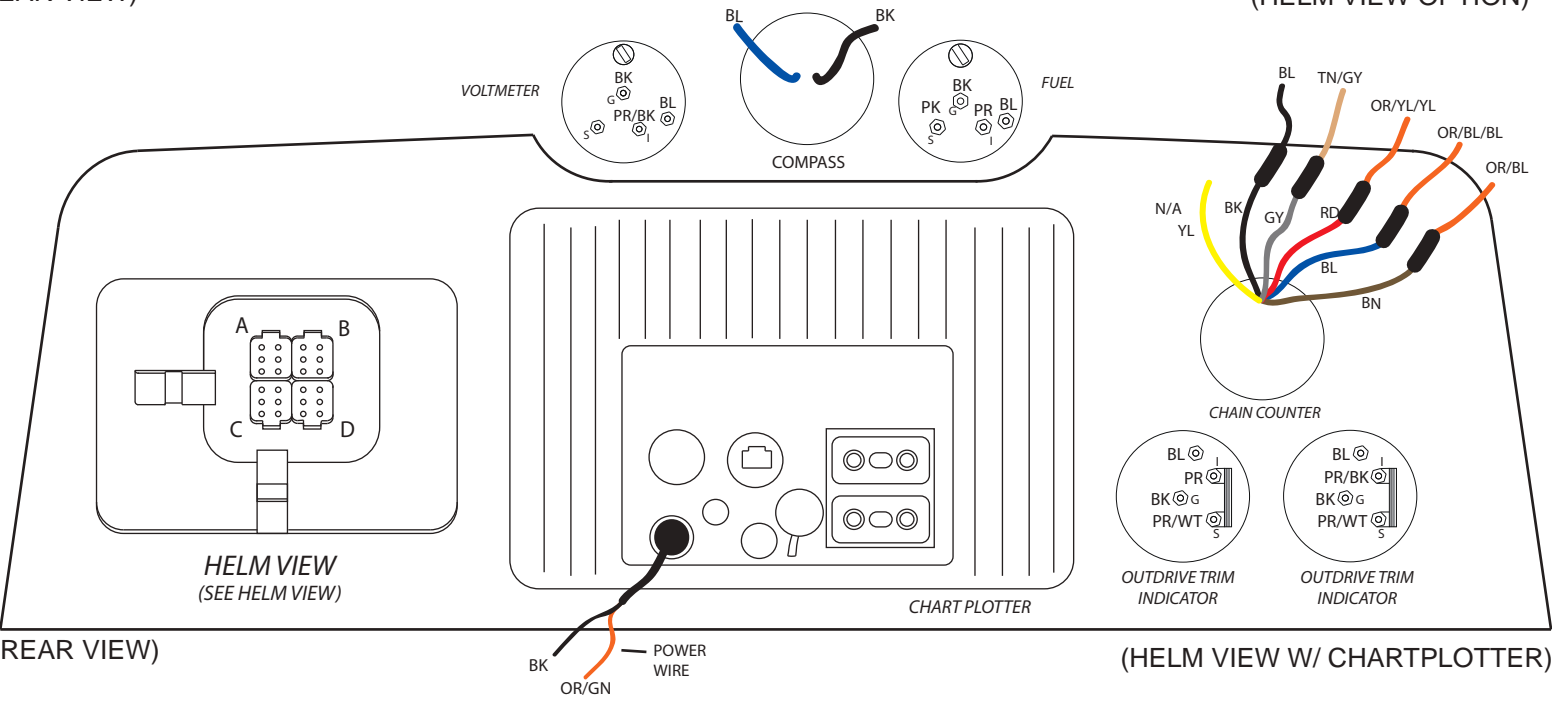

(REAR VIEW)

(HELM VIEW W/ CHARTPLOTTER)

INSTRUMENT PANEL (DTS SMARTCRAFT W/ CHARTPLOTTER)

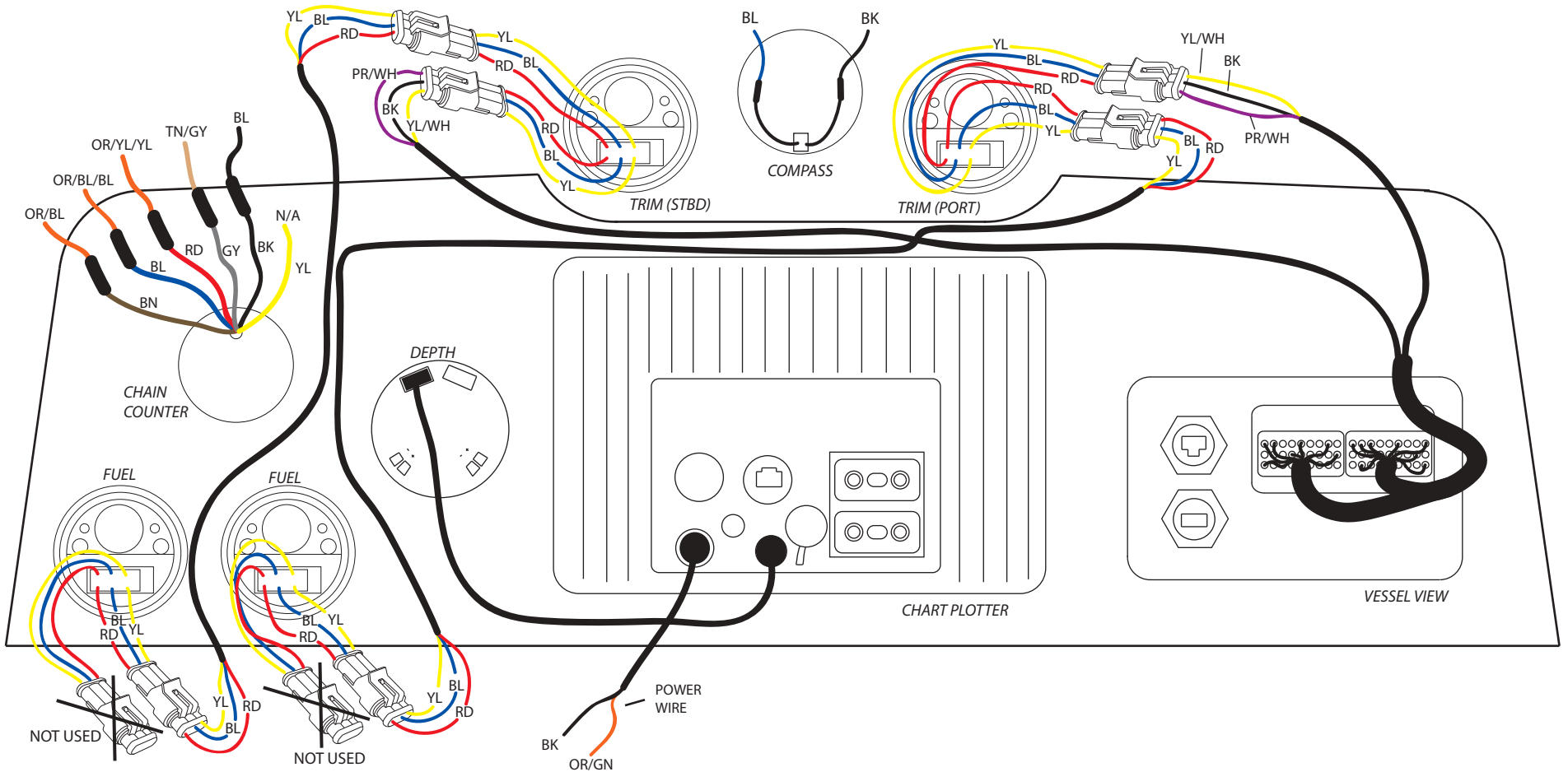

(REAR VIEW)

TRIM TAB PANEL

(STANDARD TRIM PANEL)

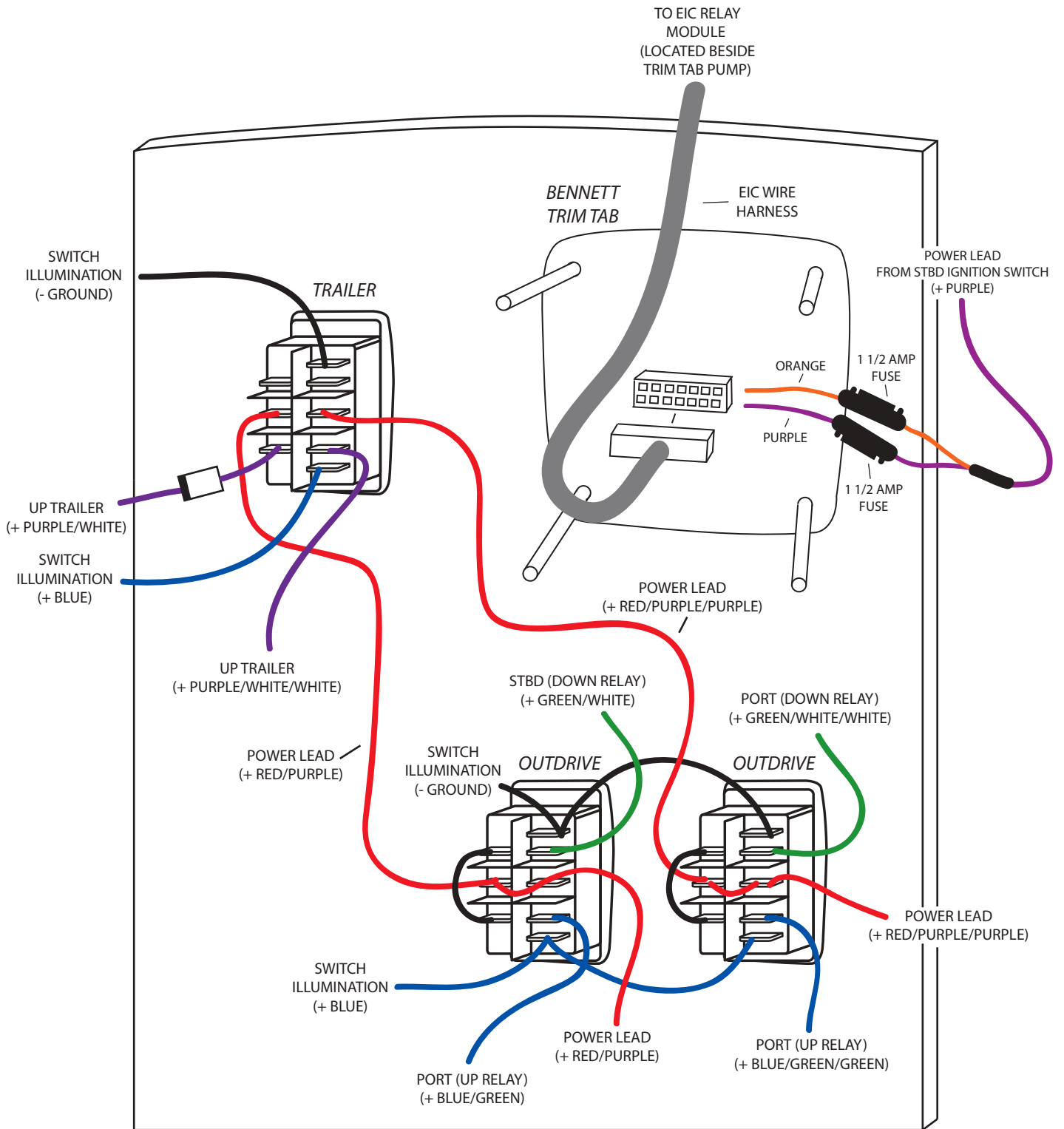

SEE OUTDRIVE PUMP FOR MORE DETAIL

TRIM TAB PANEL

(DTS TRIM PANEL)

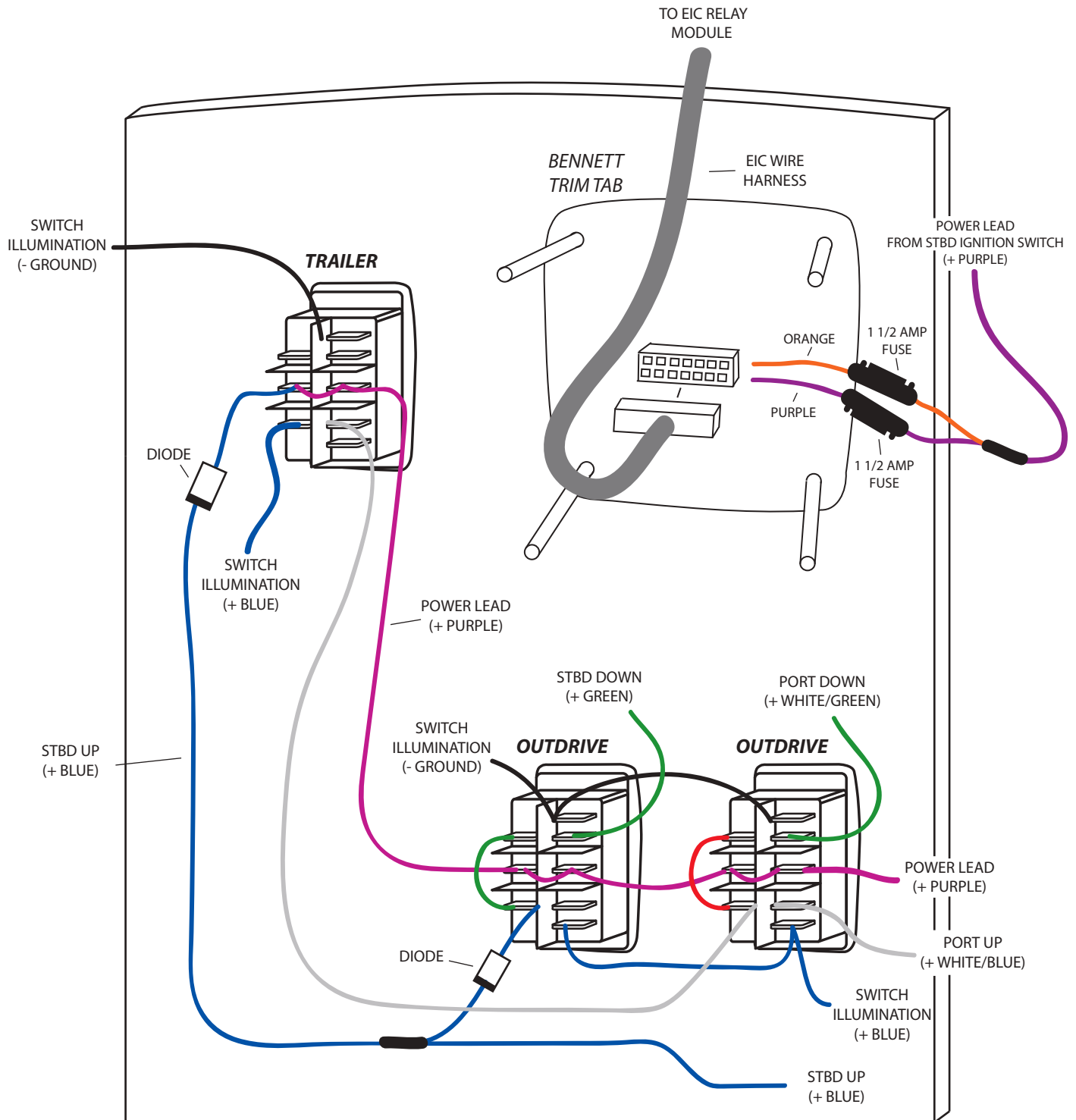

12 VOLT DC SYSTEM PANEL

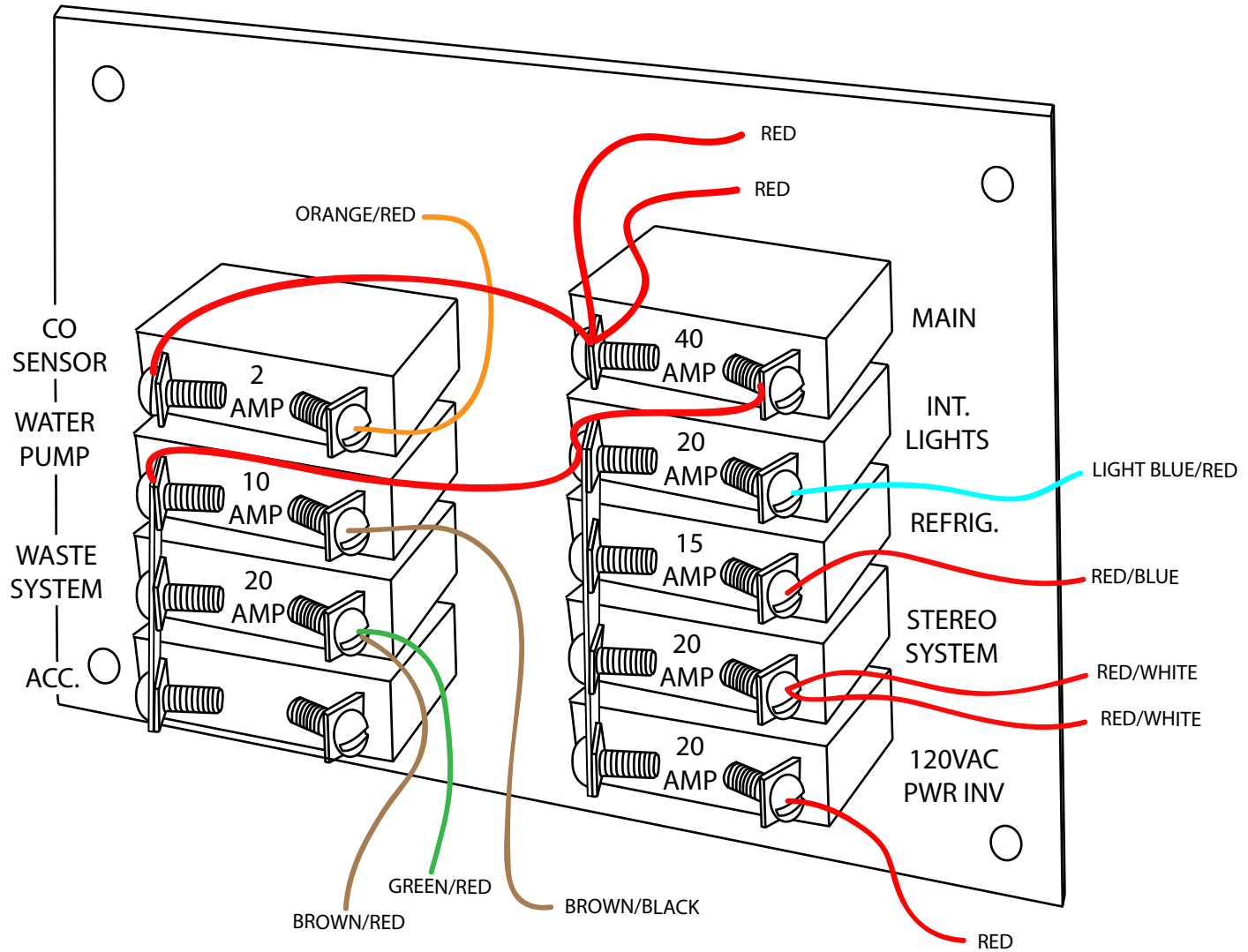

15

310BR

120V 60HZ AC SYSTEM PANEL

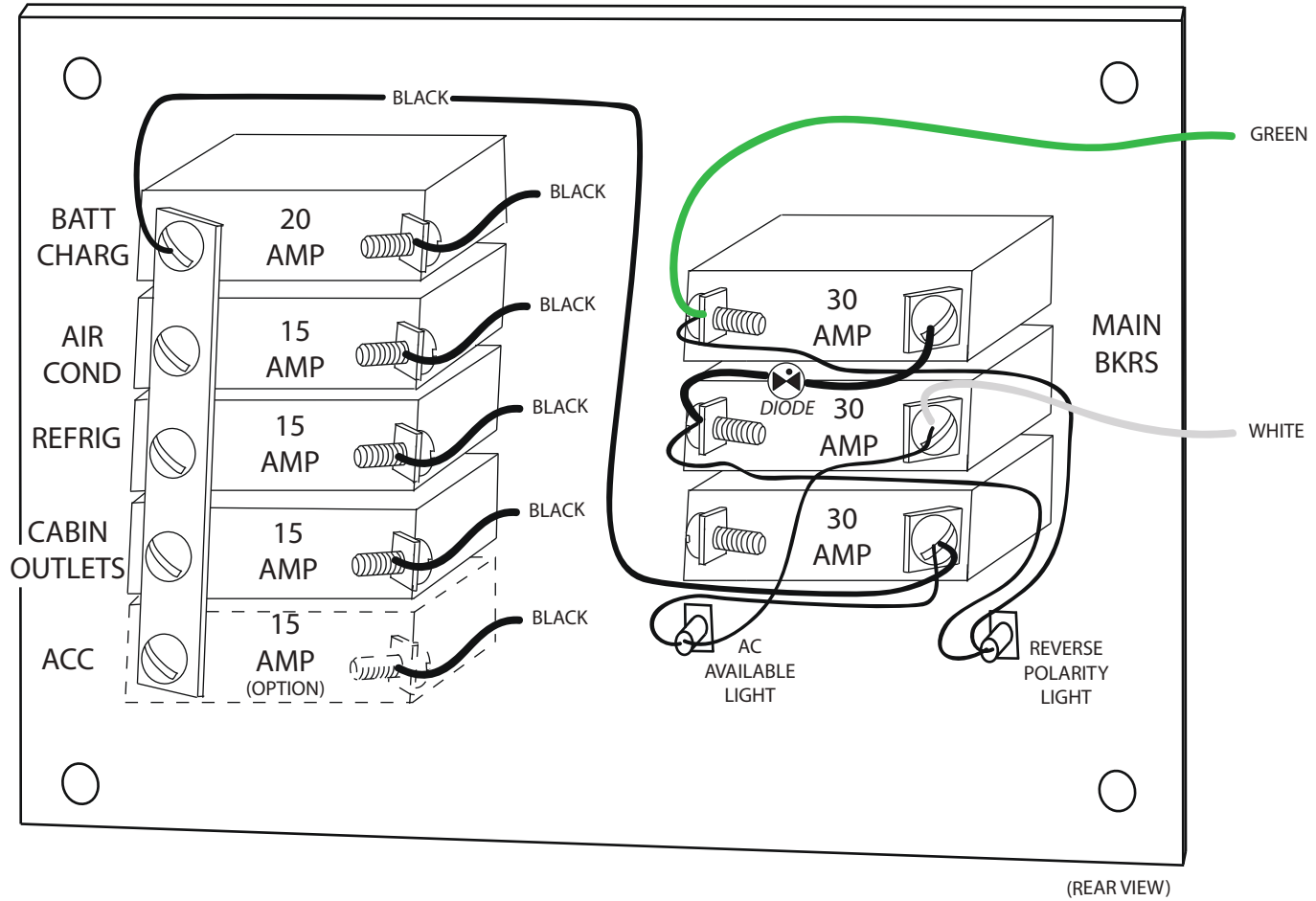

AC OUTLETS

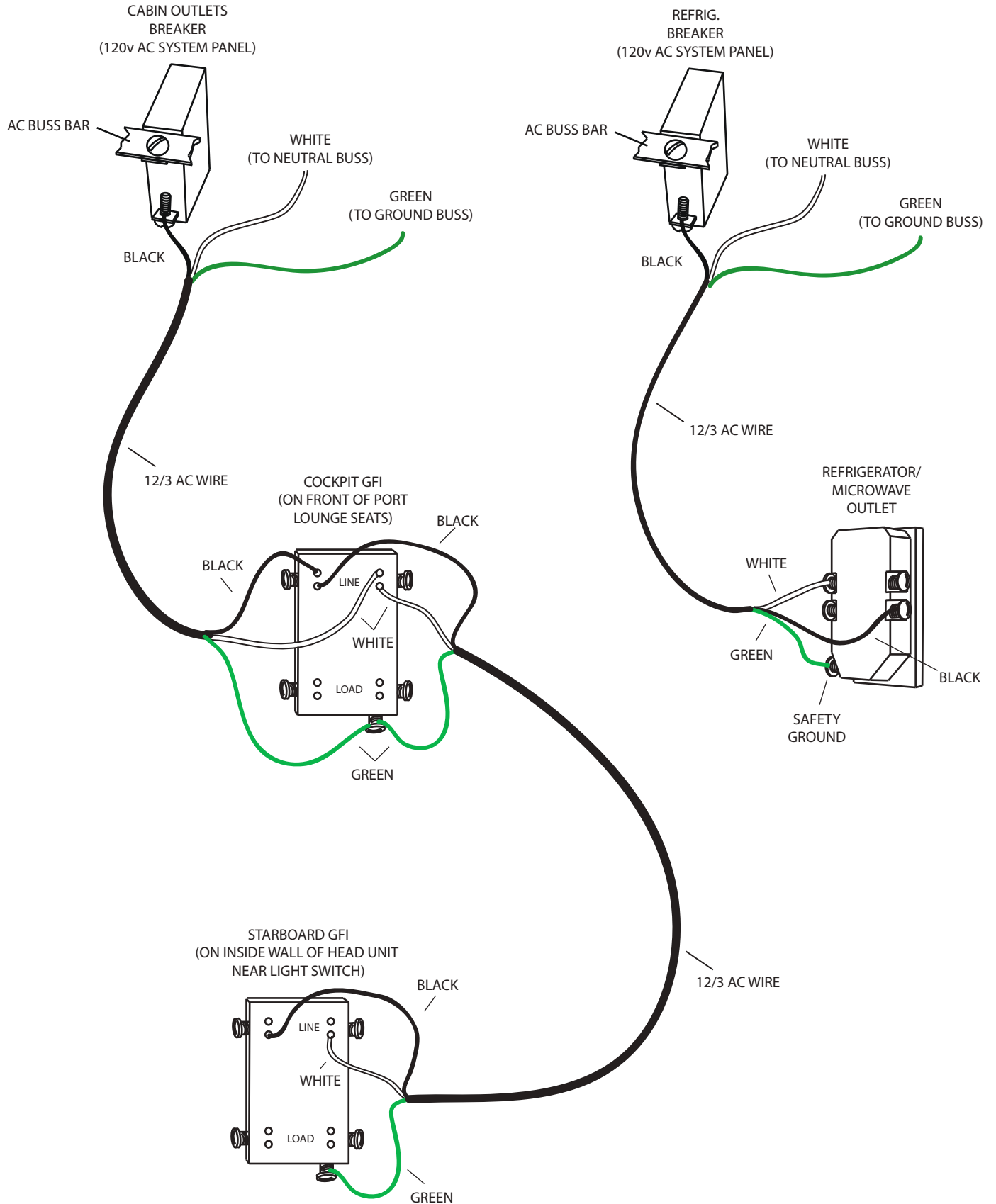

BATTERY CHARGER

(AC CURRENT)

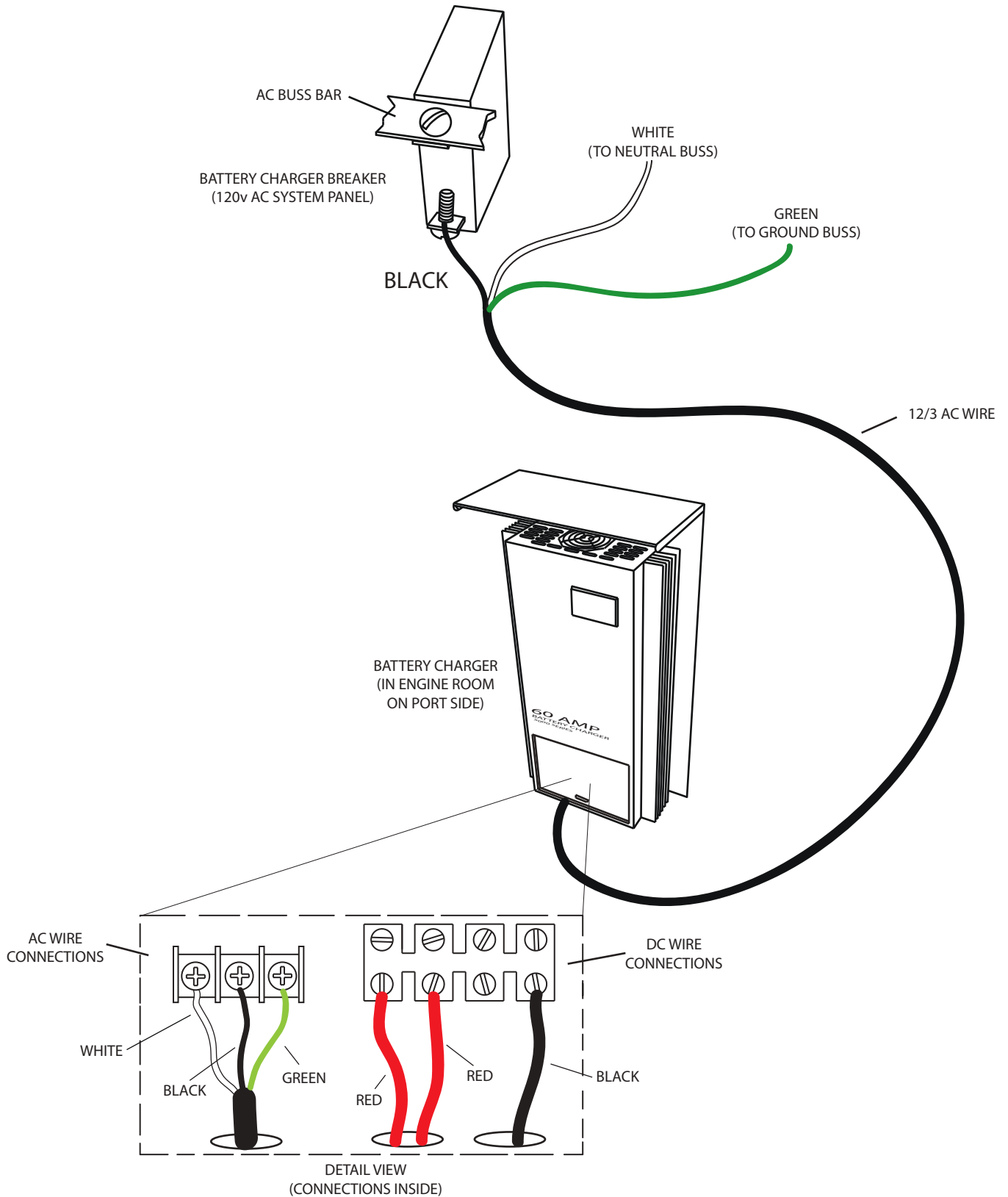

CKPT REFRIGERATOR

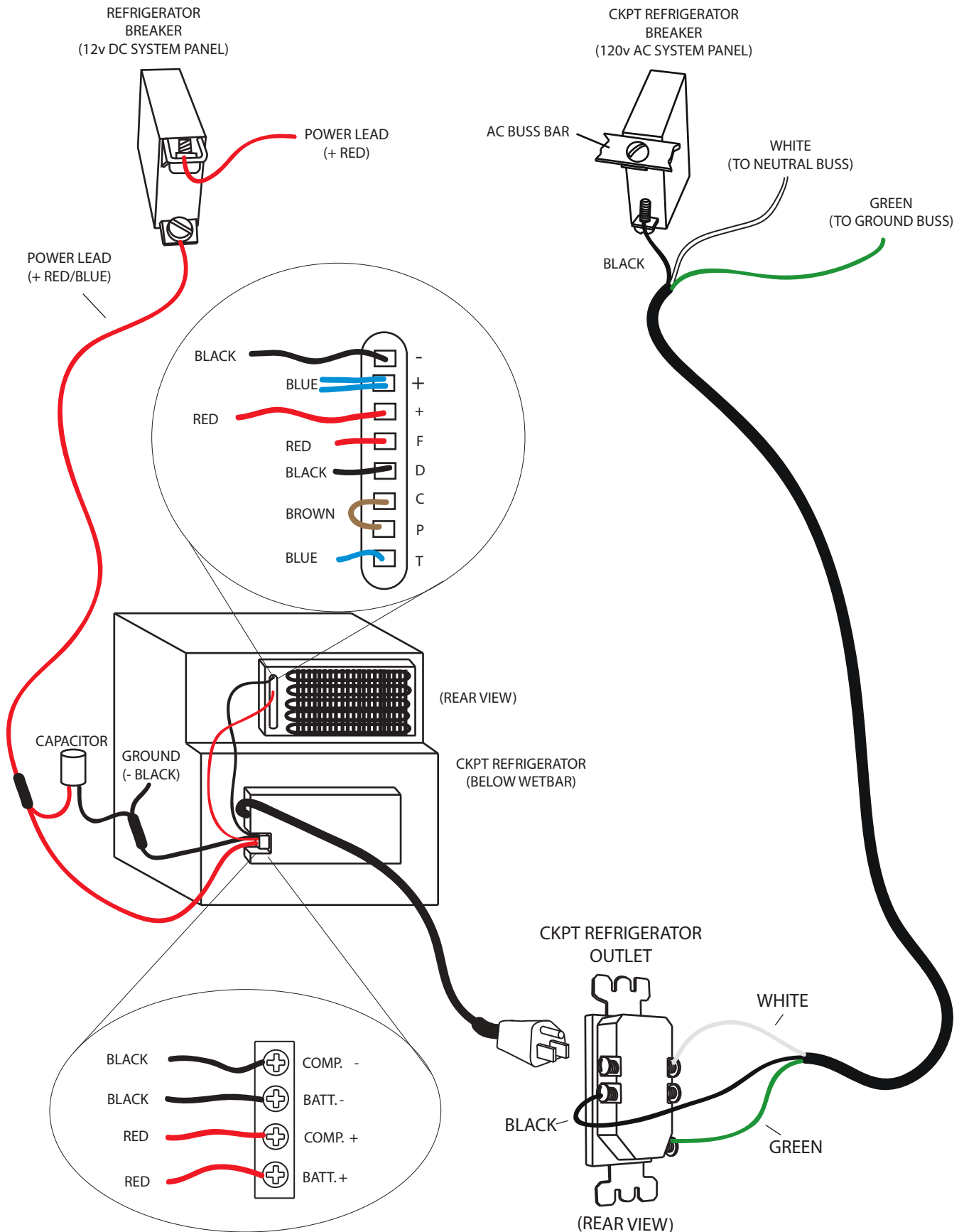

WATER HEATER

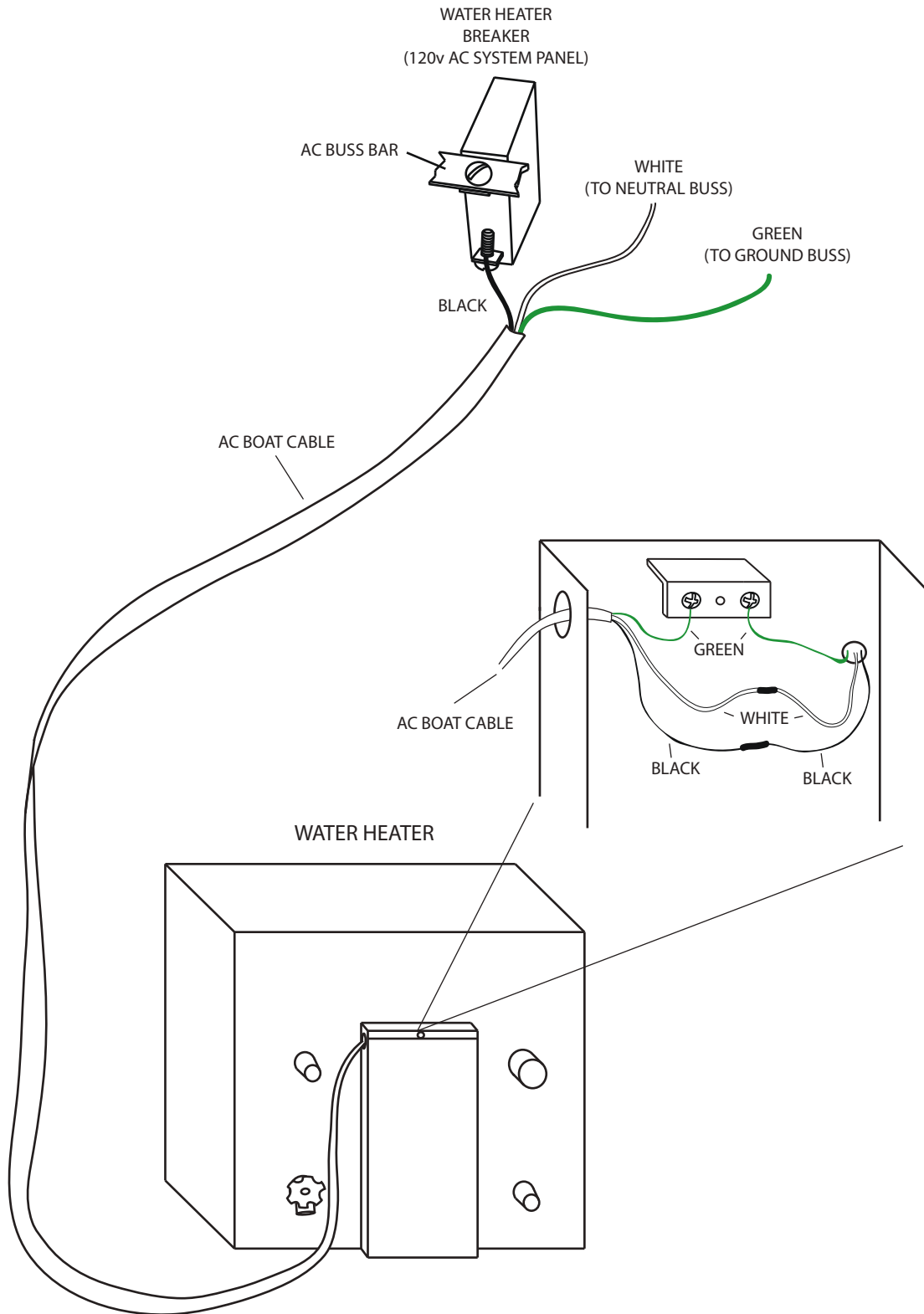

BATTERY PARALLEL SWITCH PANEL

BATTERY CHARGER

(DC CURRENT)

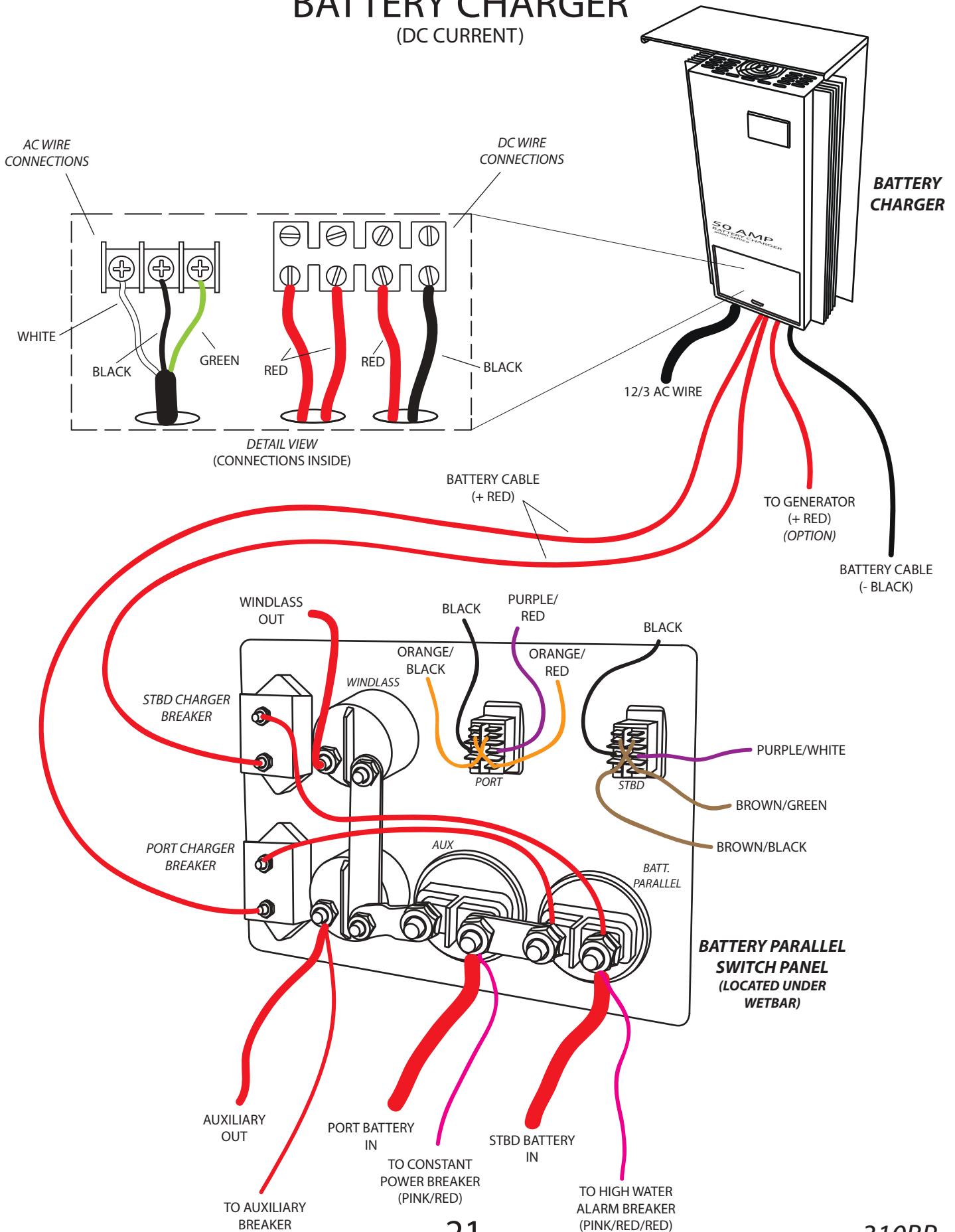

BILGE BLOWERS

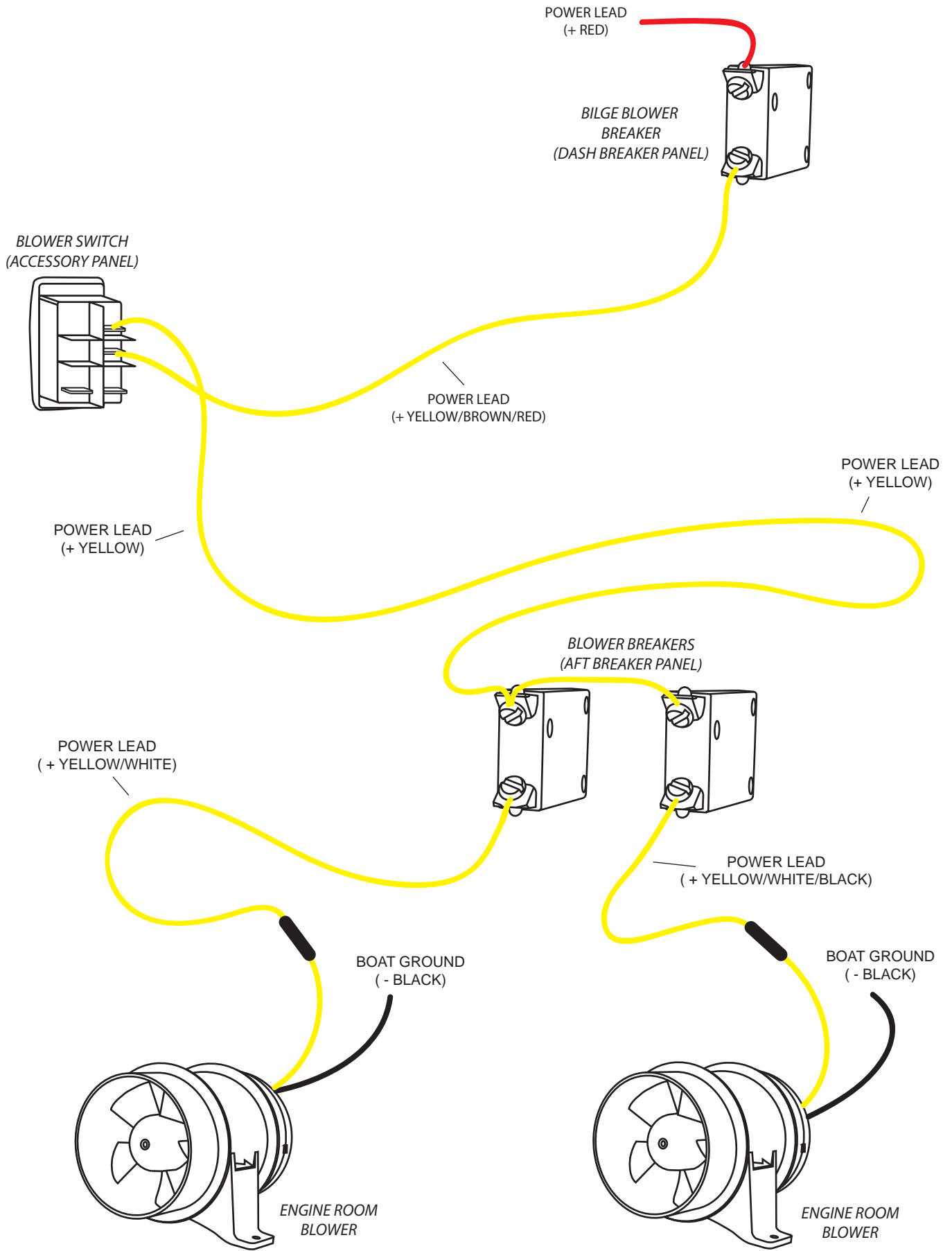

CABIN BILGE PUMP

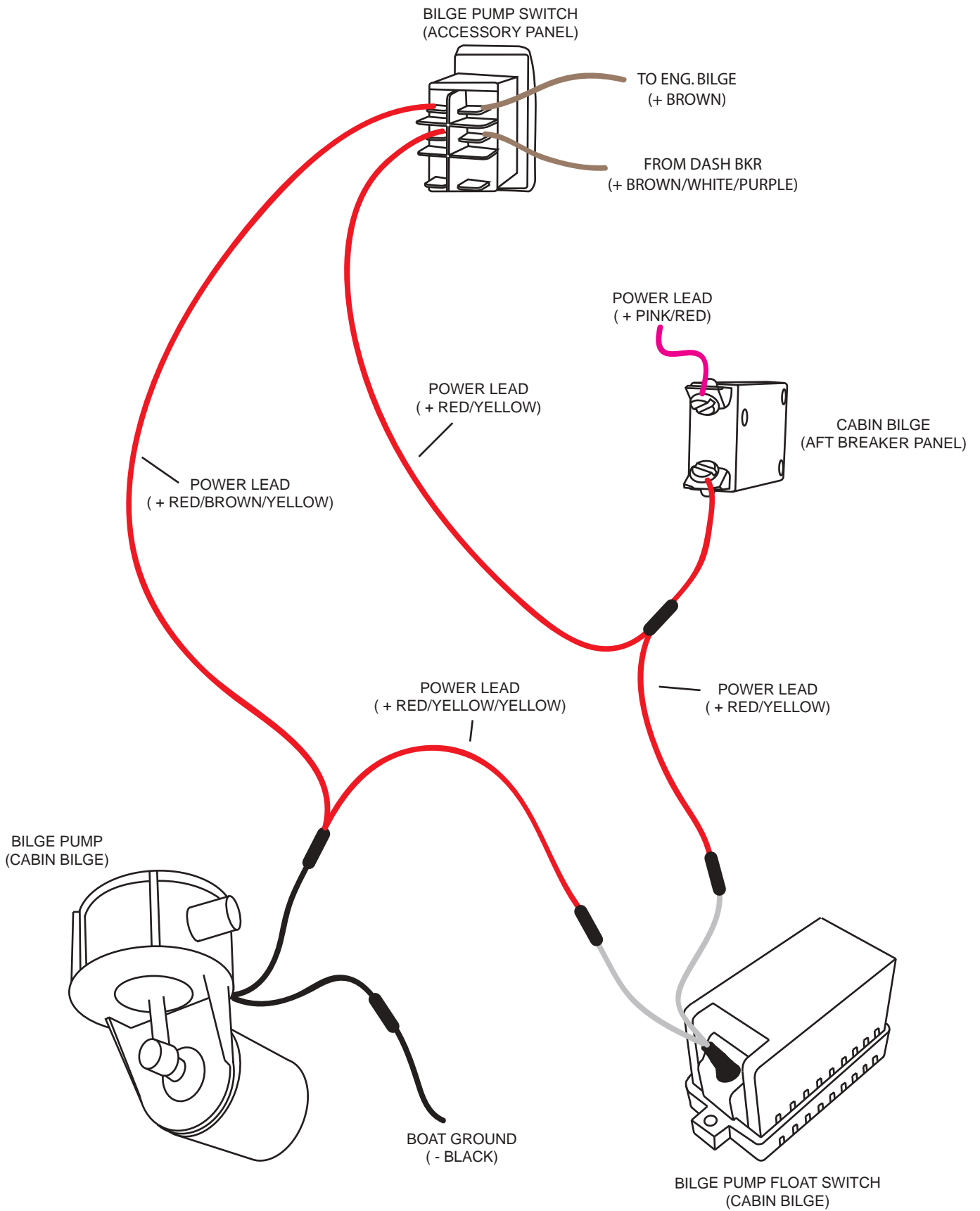

ENGINE BILGE PUMP

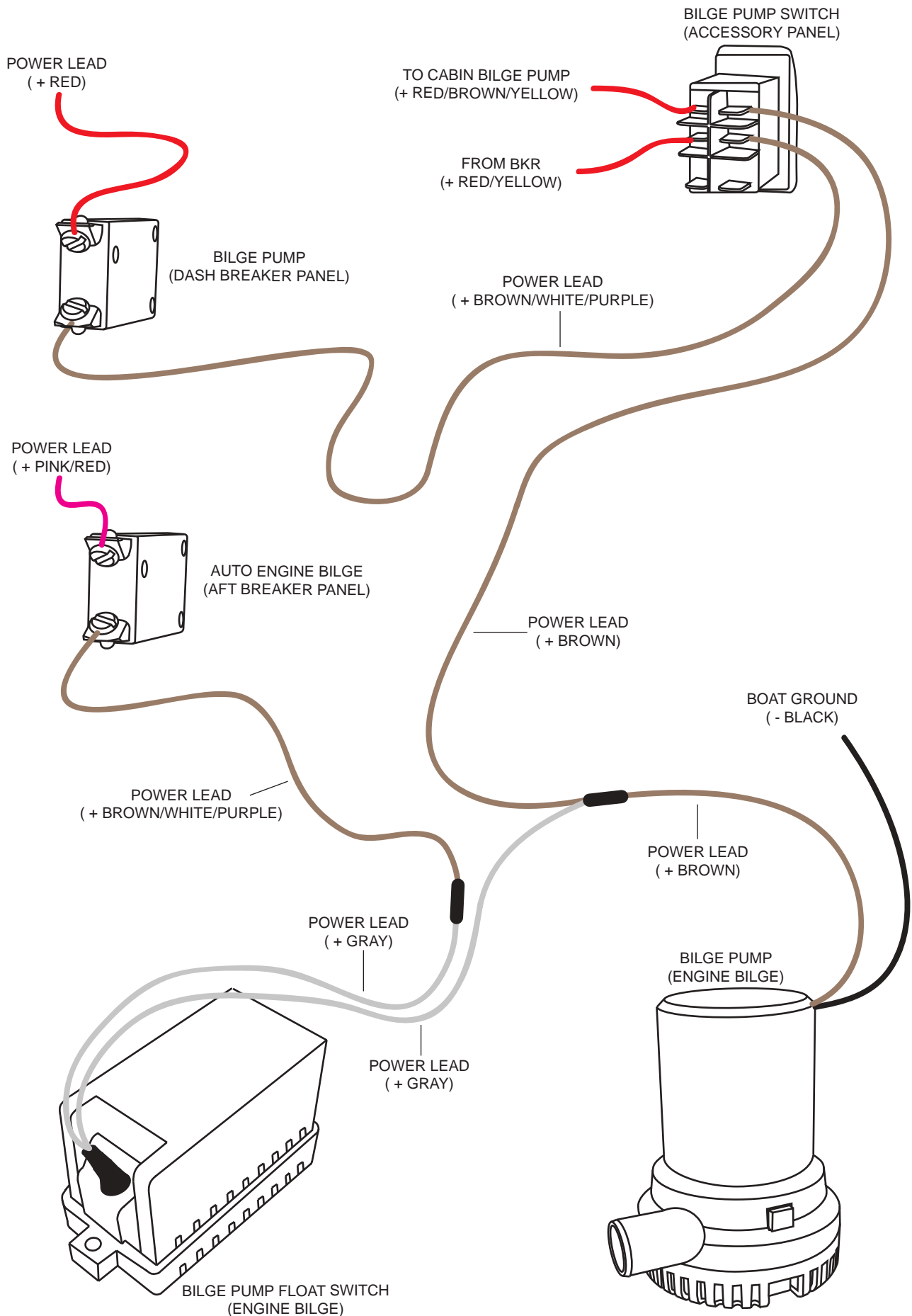

CABINET LIGHT

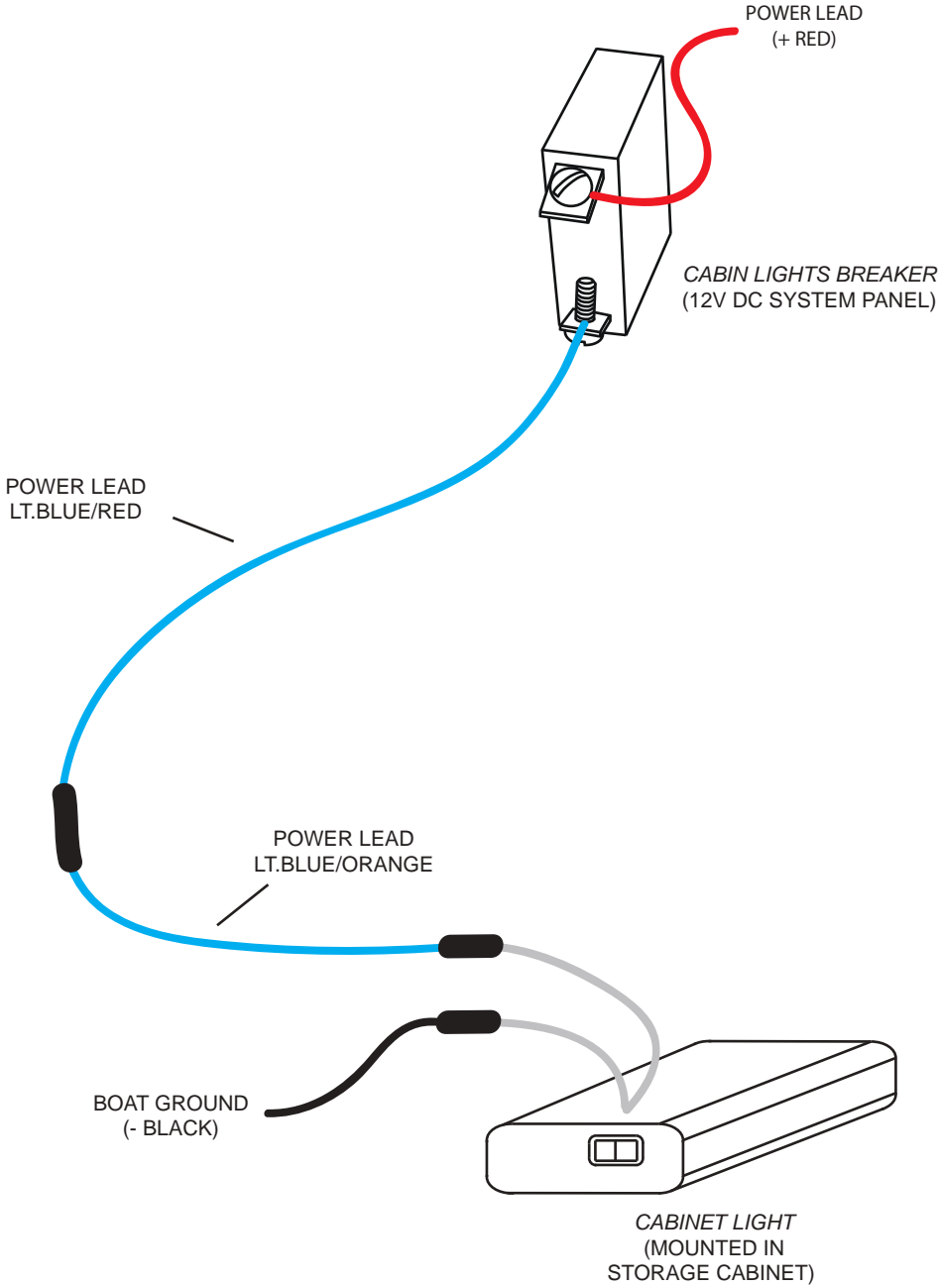

CAPTAIN'S CALL (PORT ENGINE)

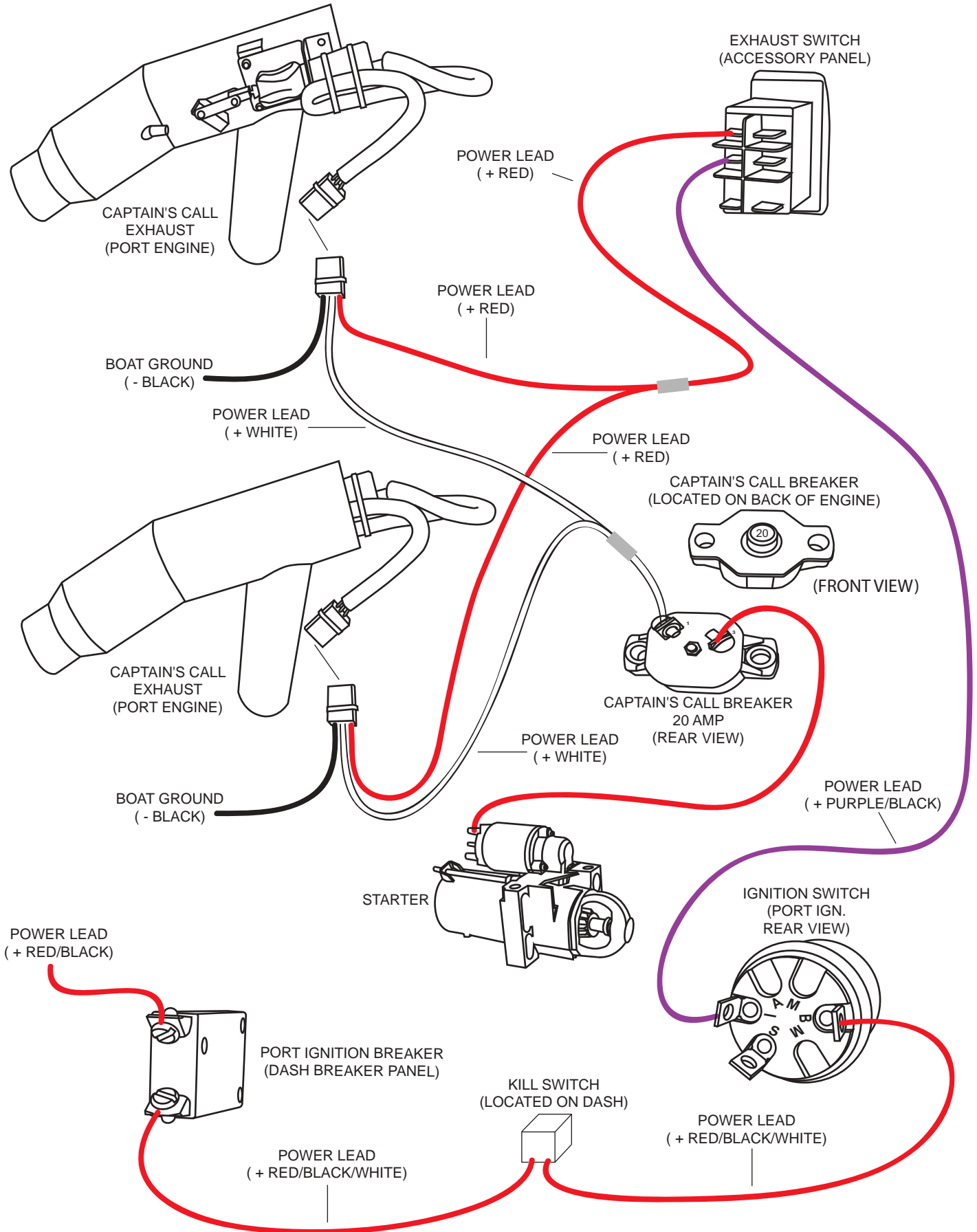

CAPTAIN'S CALL

(STARBOARD ENGINE)

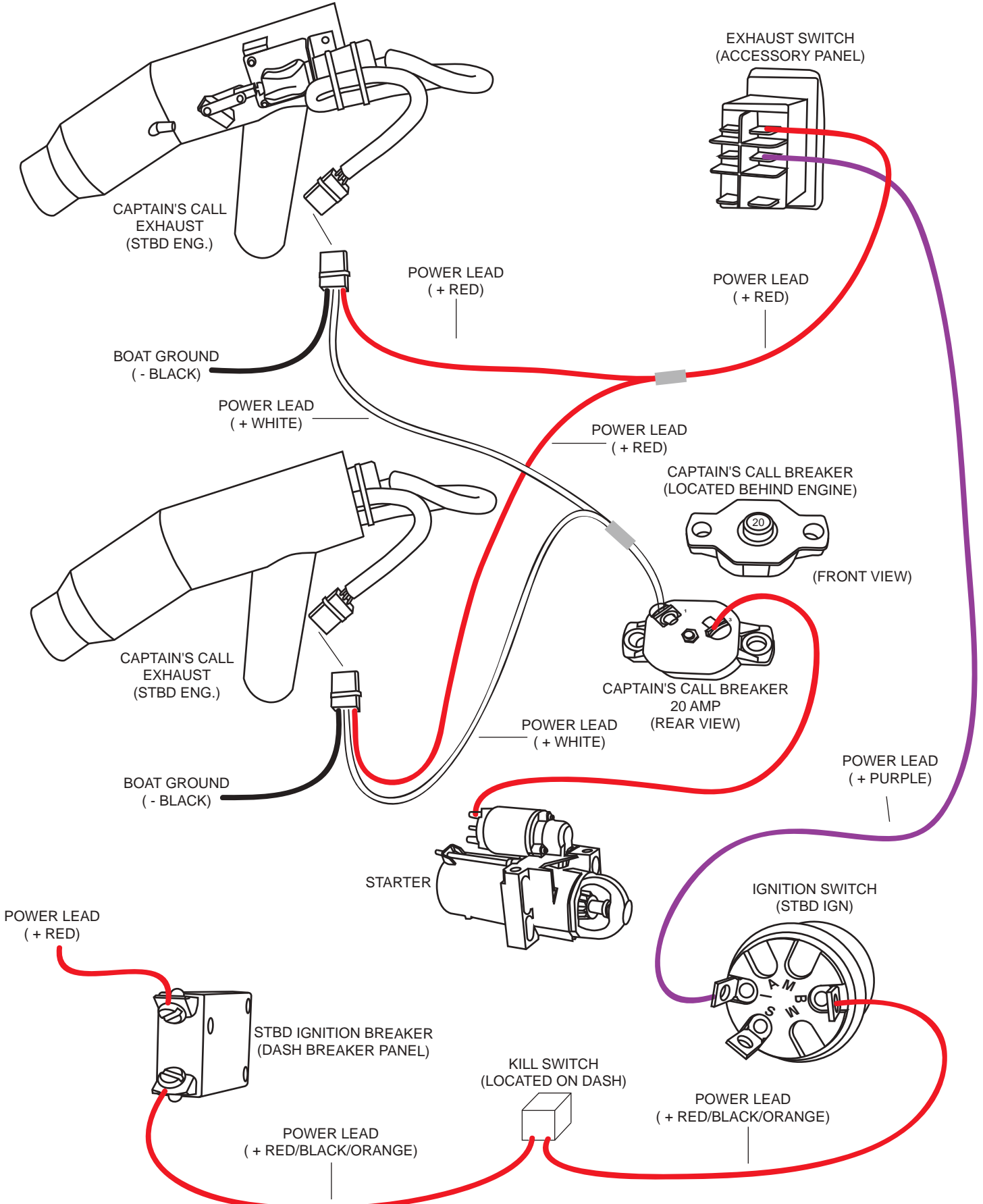

CO DETECTOR

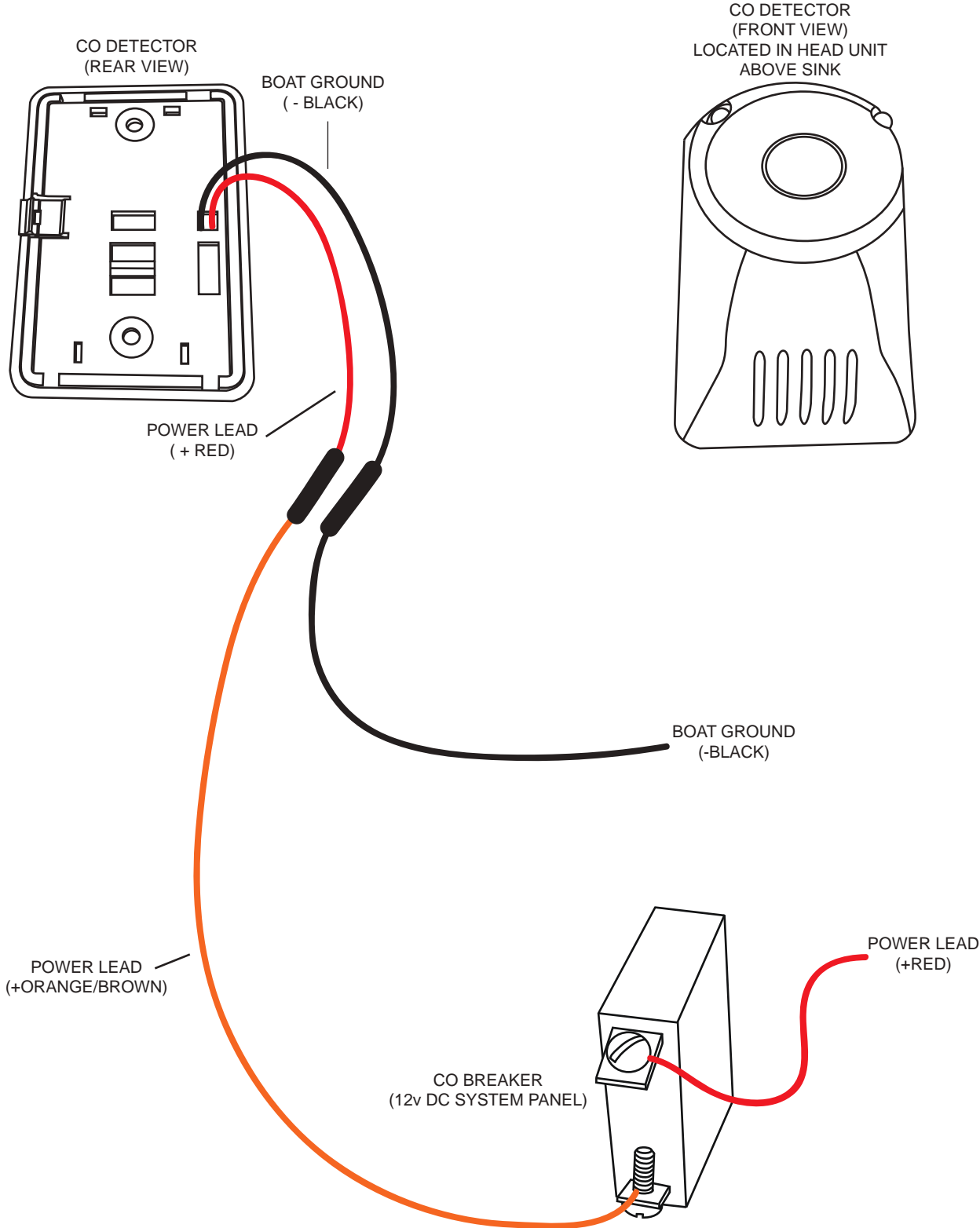

COURTESY LIGHTS

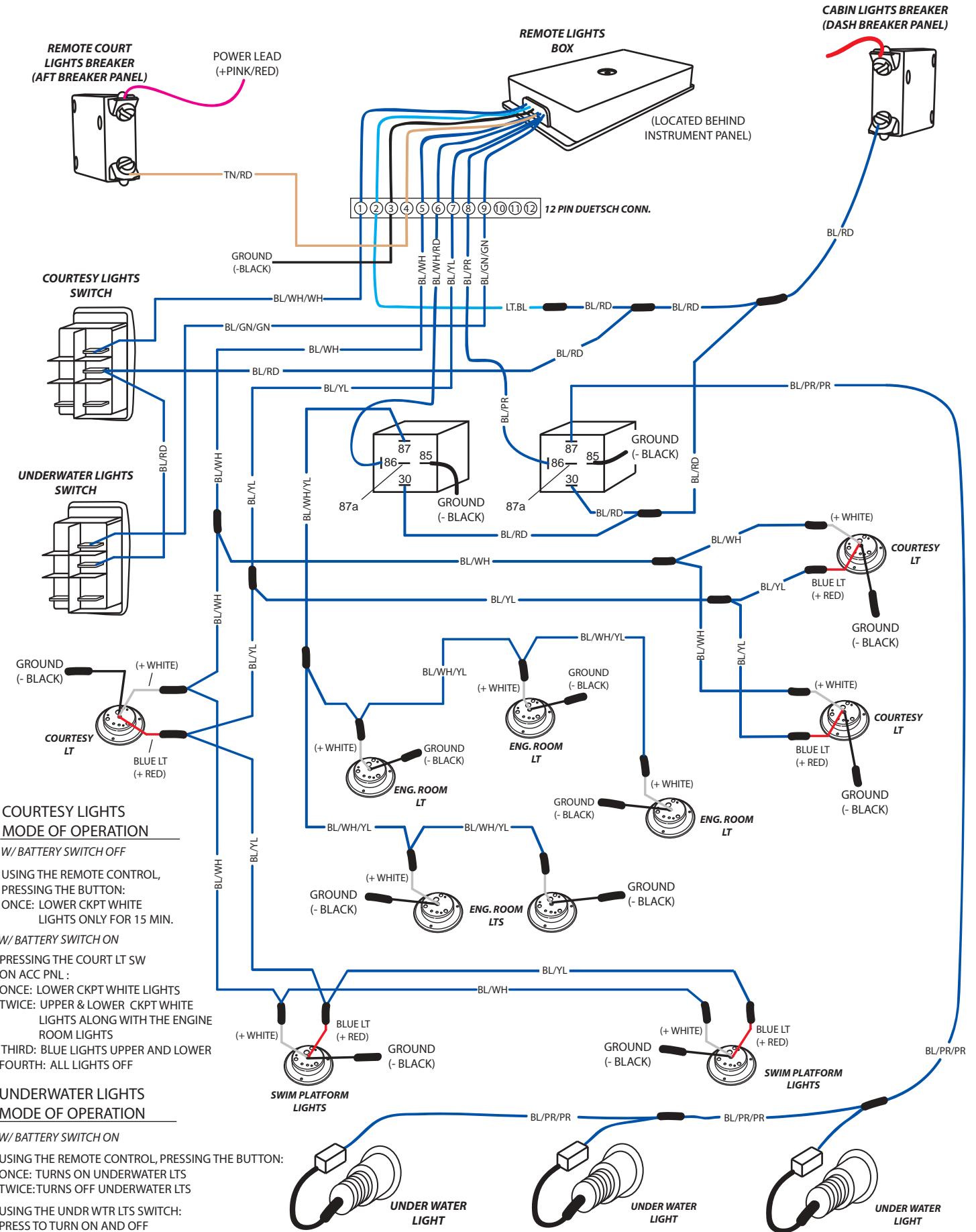

COURTESY LIGHTS MODE OF OPERATION

W/ BATTERY SWITCH OFF

USING THE REMOTE CONTROL,
PRESSING THE BUTTON:
ONCE: LOWER CKPT WHITE
LIGHTS ONLY FOR 15 MIN.

W/ BATTERY SWITCH ON

PRESSING THE COURT LT SW
ON ACC PNL :
ONCE: LOWER CKPT WHITE LIGHTS
TWICE: UPPER & LOWER CKPT WHITE
LIGHTS ALONG WITH THE ENGINE
ROOM LIGHTS
THIRD: BLUE LIGHTS UPPER AND LOWER
FOURTH: ALL LIGHTS OFF

UNDERWATER LIGHTS MODE OF OPERATION

W/ BATTERY SWITCH ON

USING THE REMOTE CONTROL, PRESSING THE BUTTON:
ONCE: TURNS ON UNDERWATER LTS
TWICE: TURNS OFF UNDERWATER LTS

USING THE UNDR WTR LTS SWITCH:
PRESS TO TURN ON AND OFF

12V DASH OUTLET

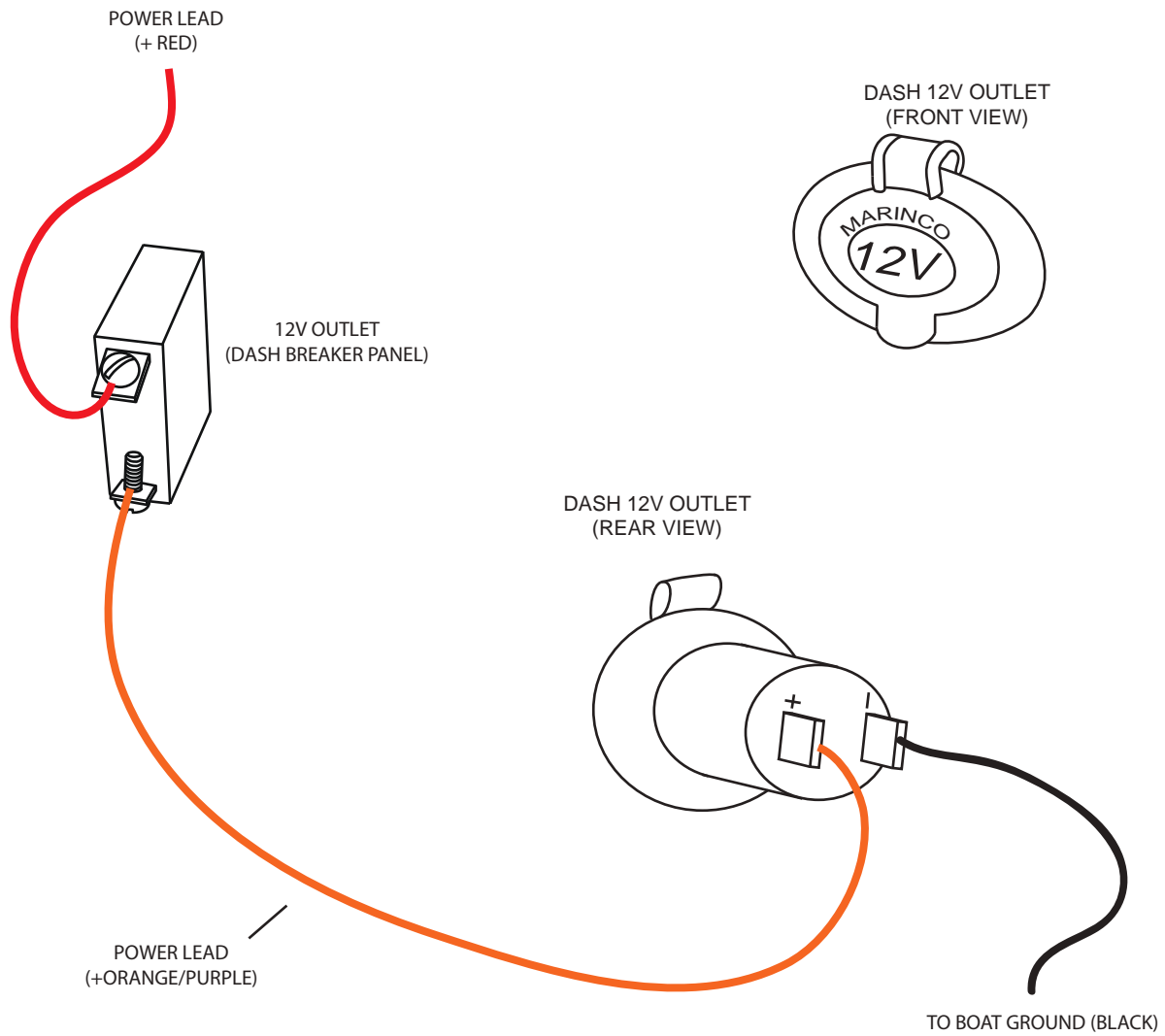

DEPTH SOUNDER

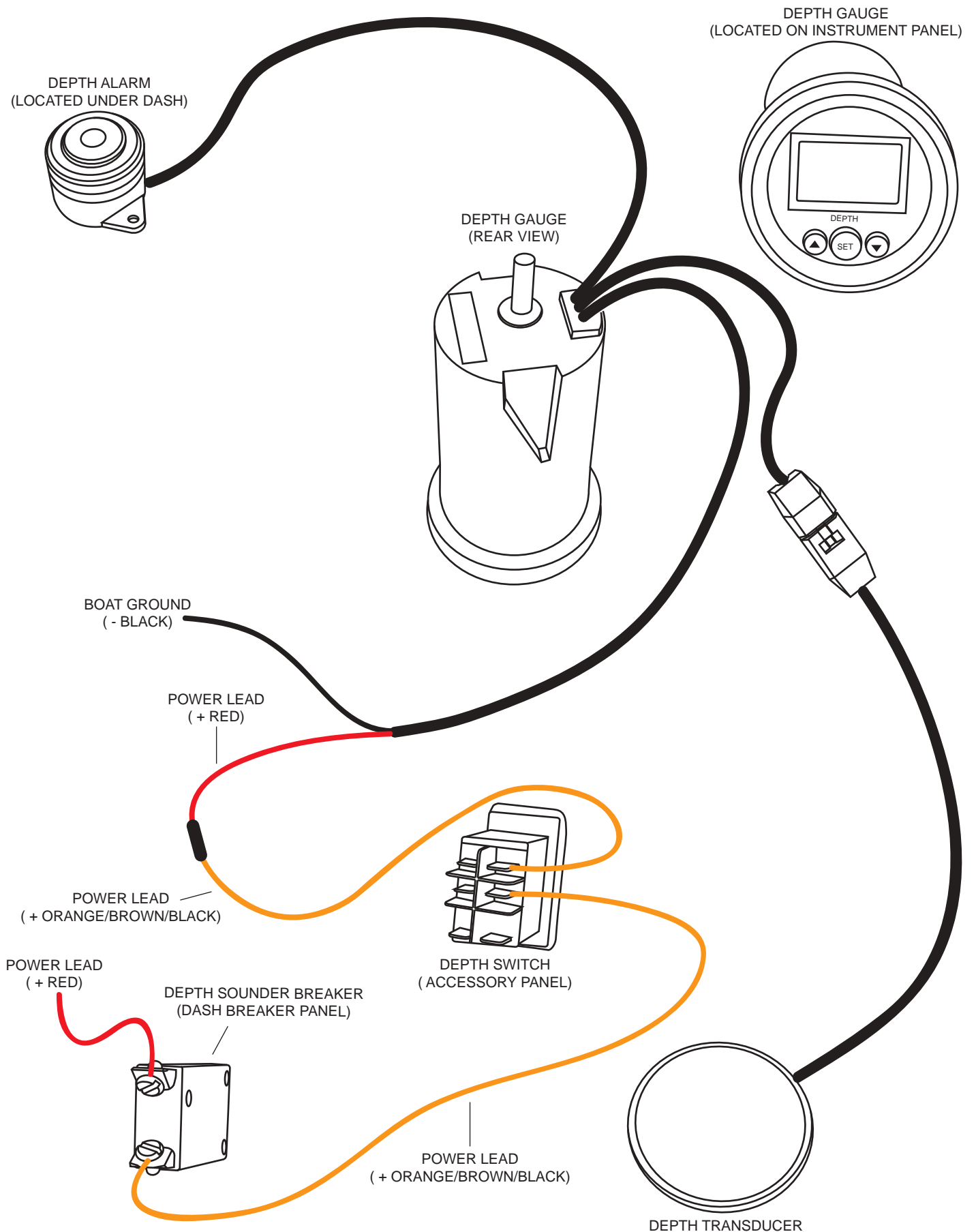

DOCKING LIGHTS

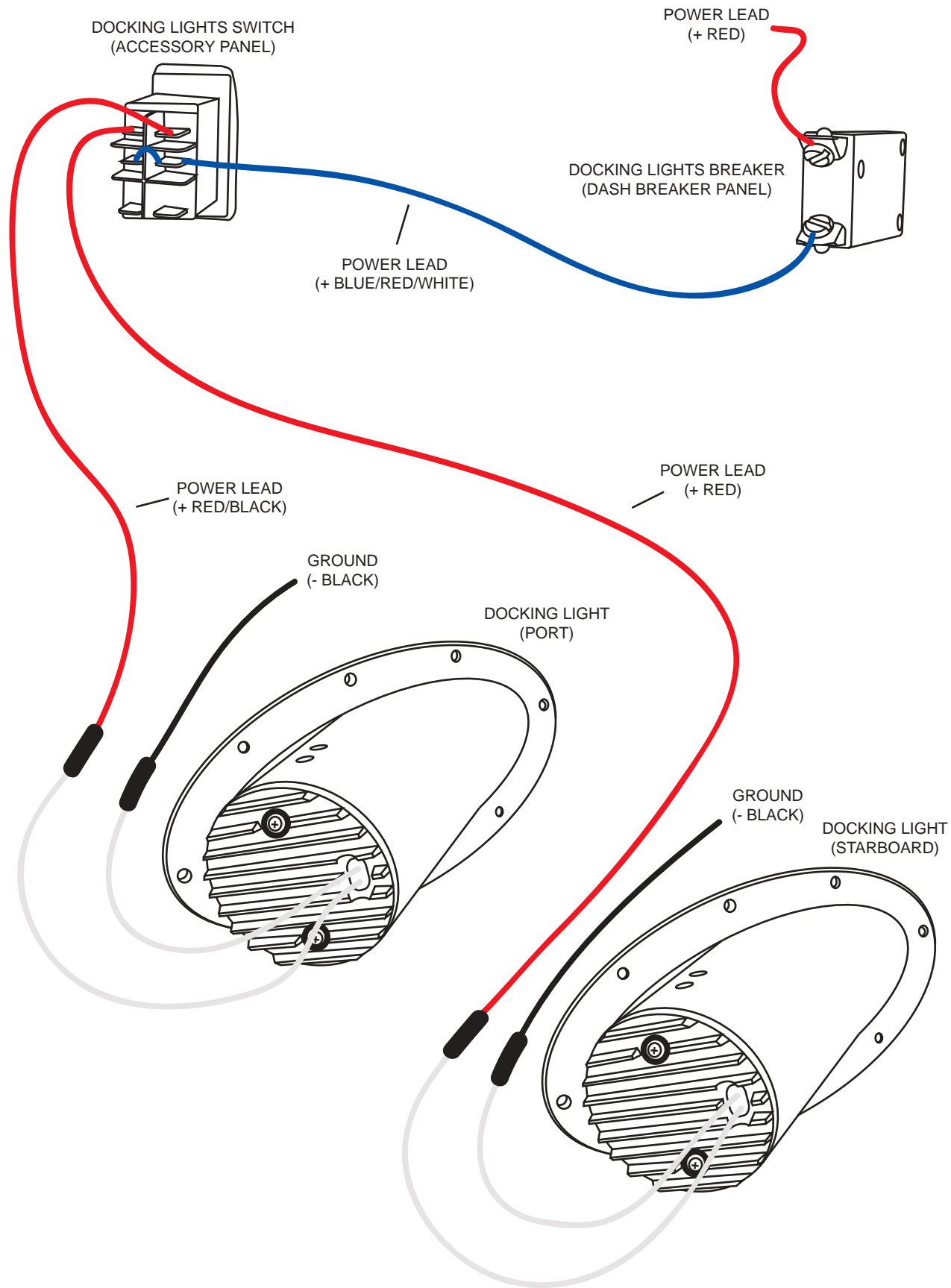

ENGINE HATCH RAM

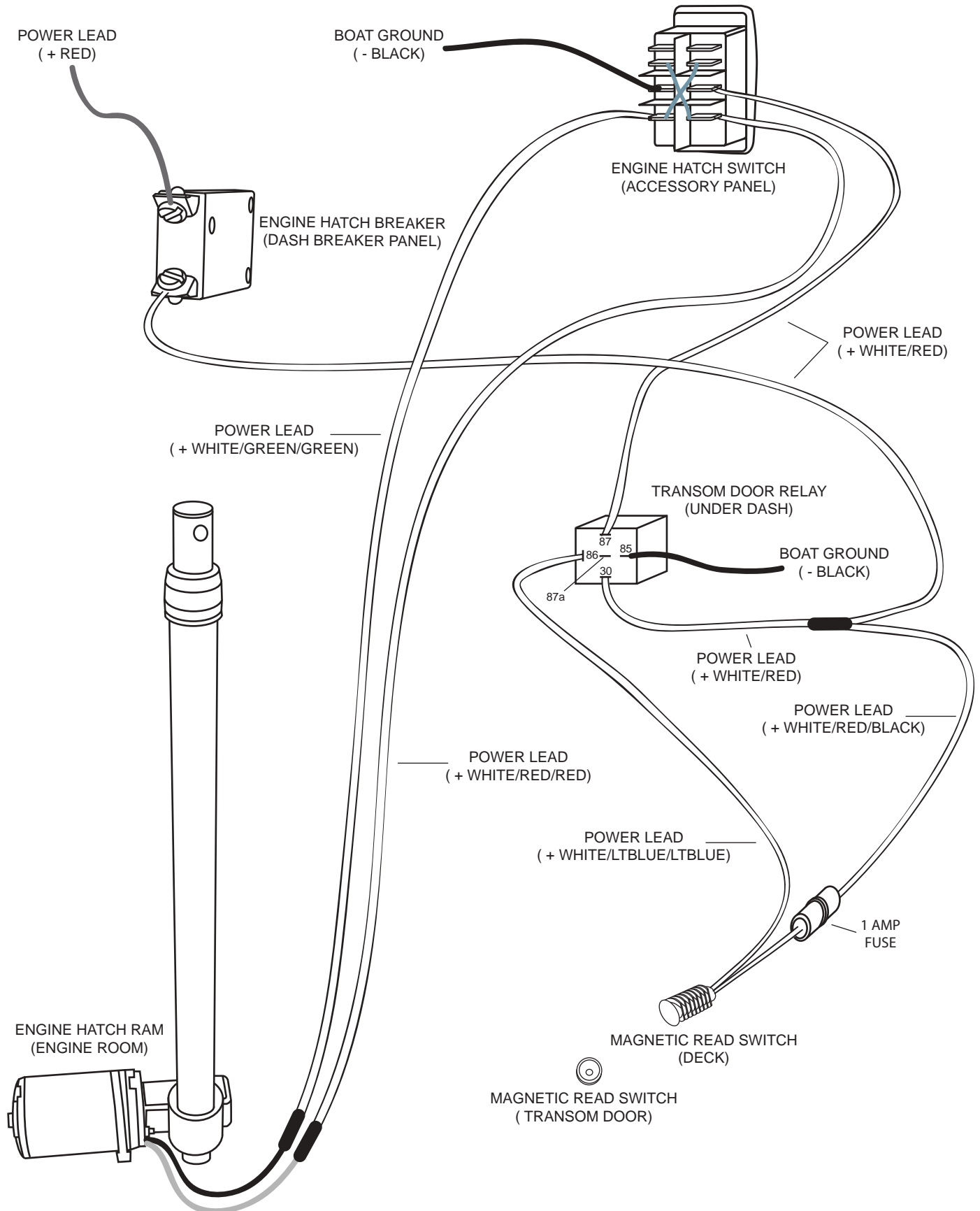

FIRE EXTINGUISHER SYSTEM

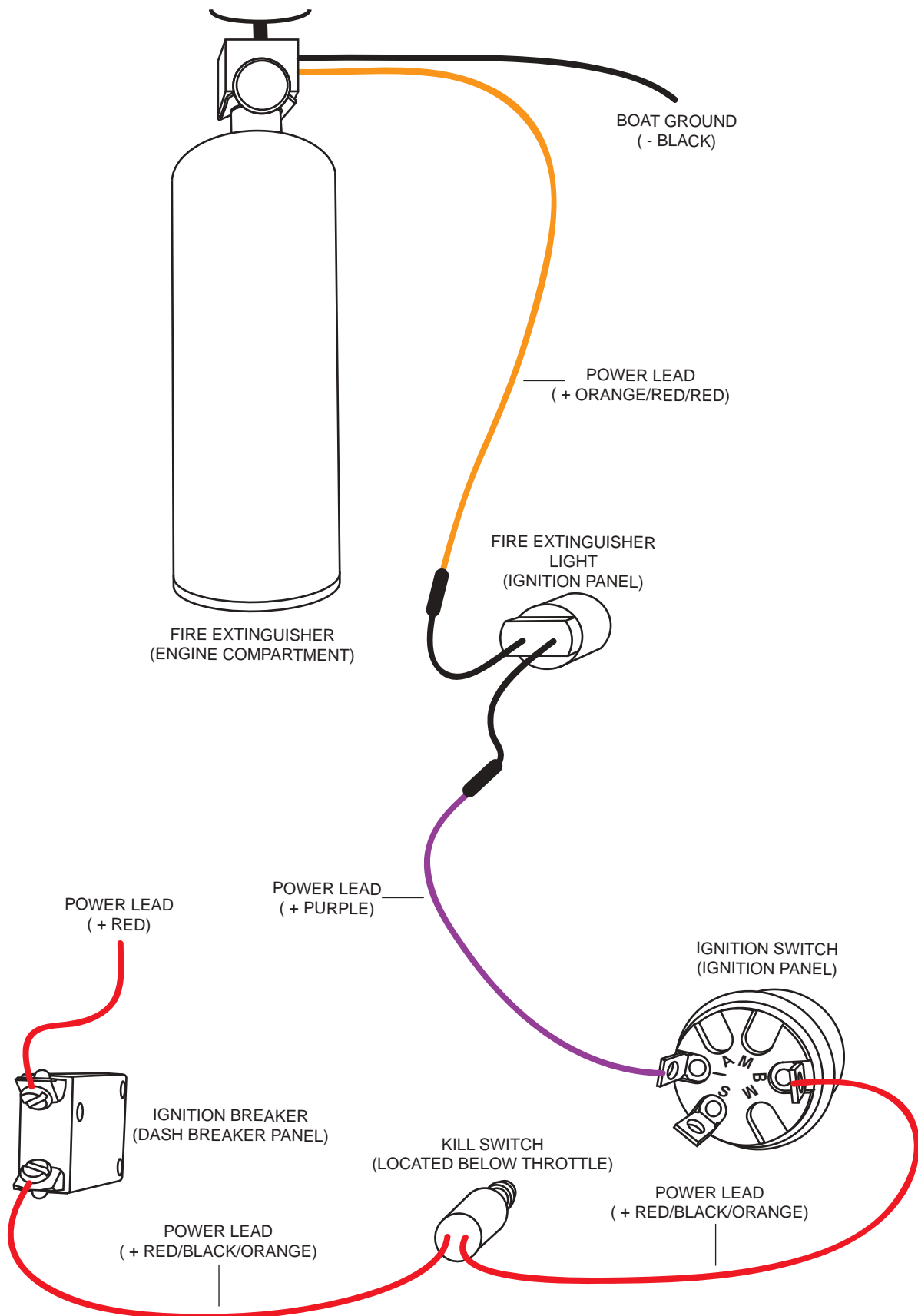

FUME DETECTOR

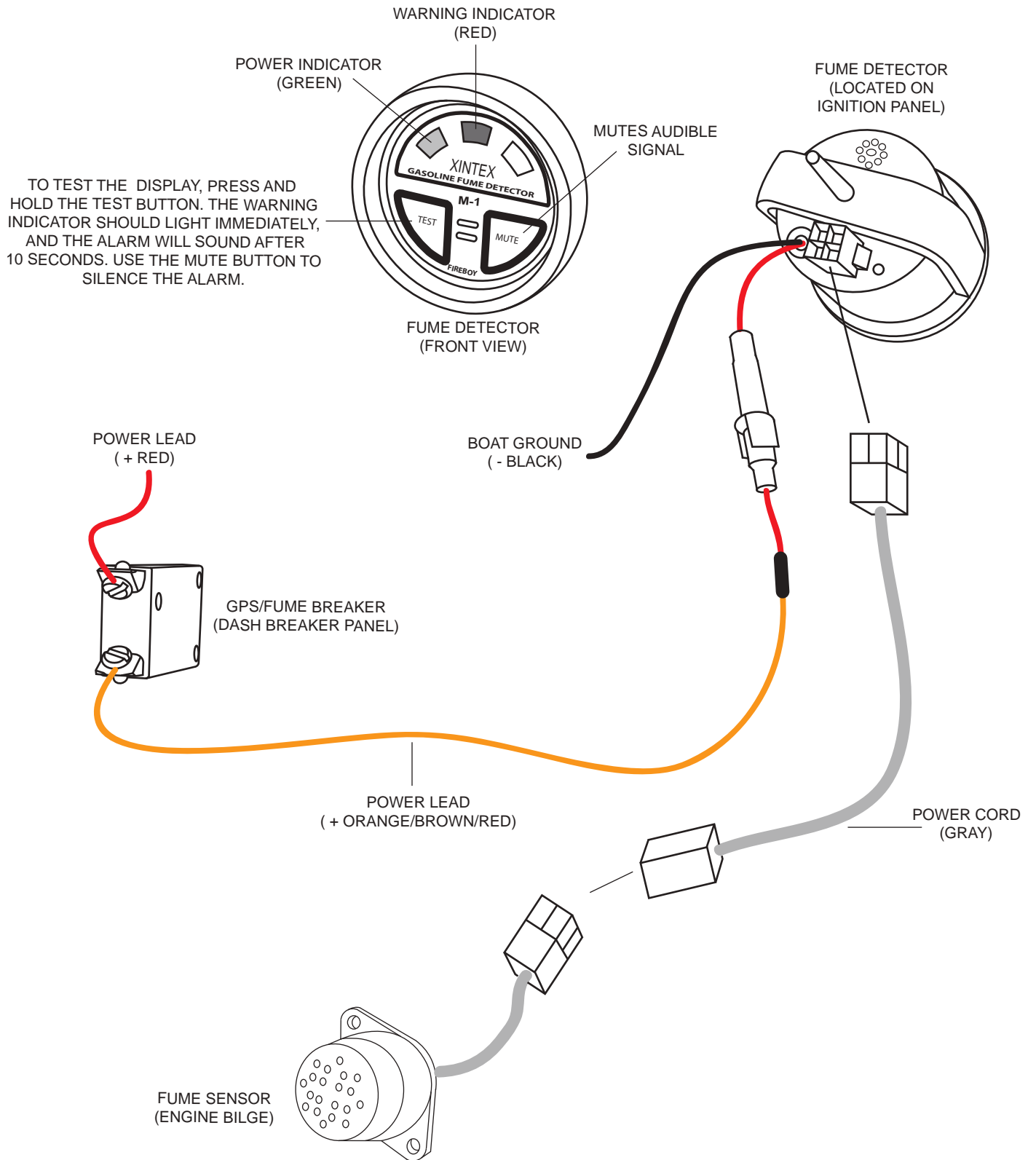

HEAD BLOWER

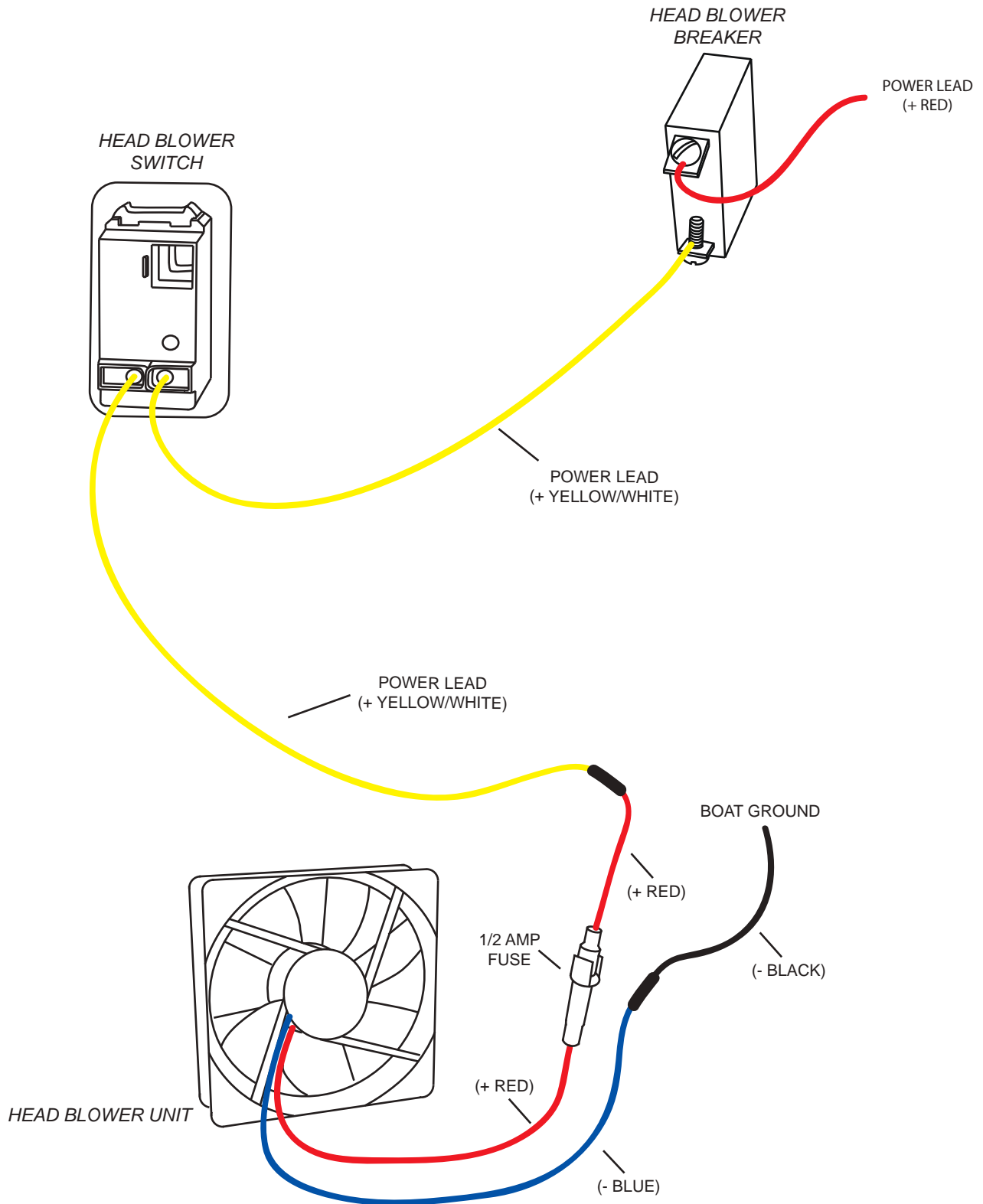

HEAD UNIT LIGHT

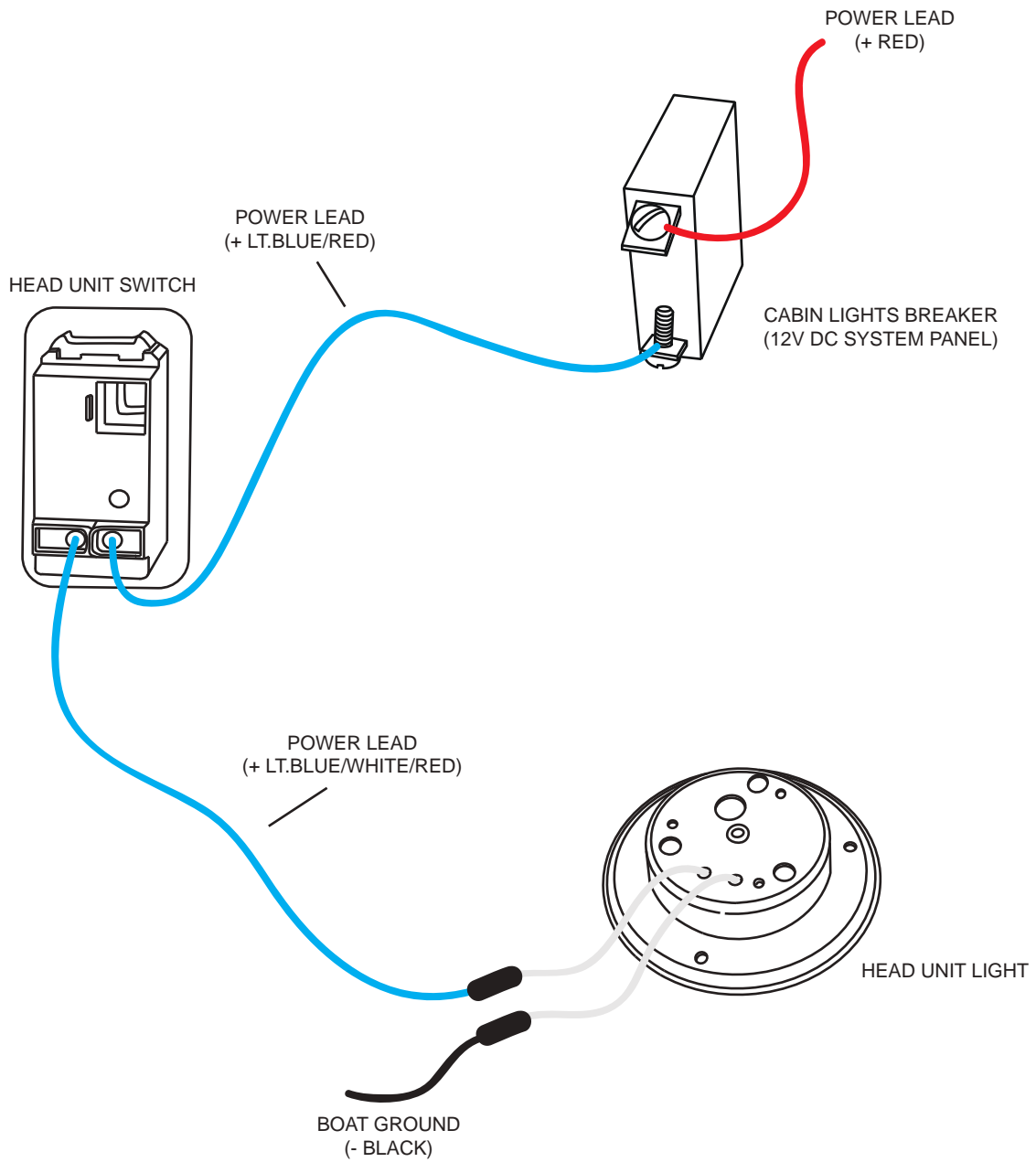

HELM VIEW

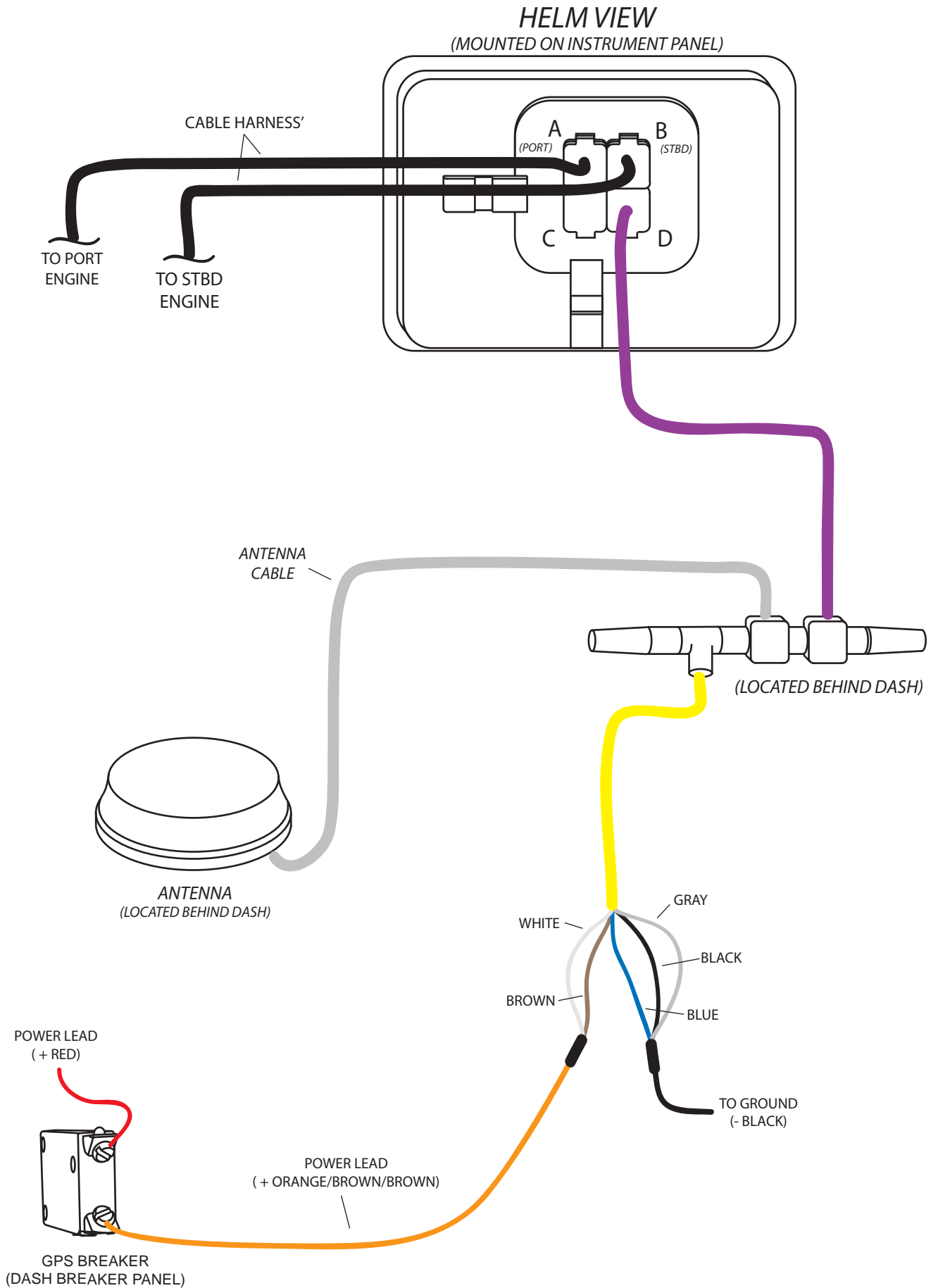

HIGH WATER ALARM

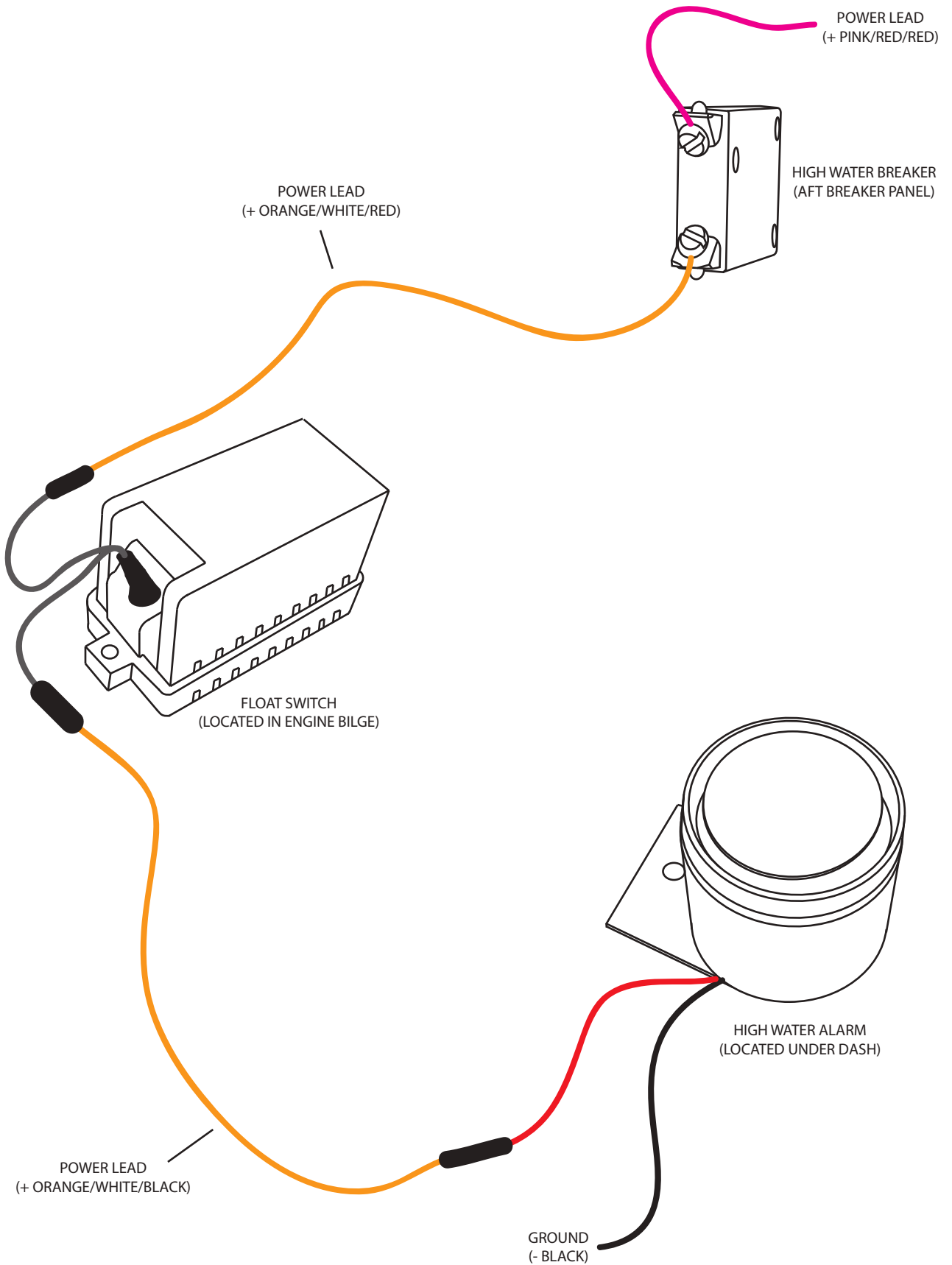

HORN

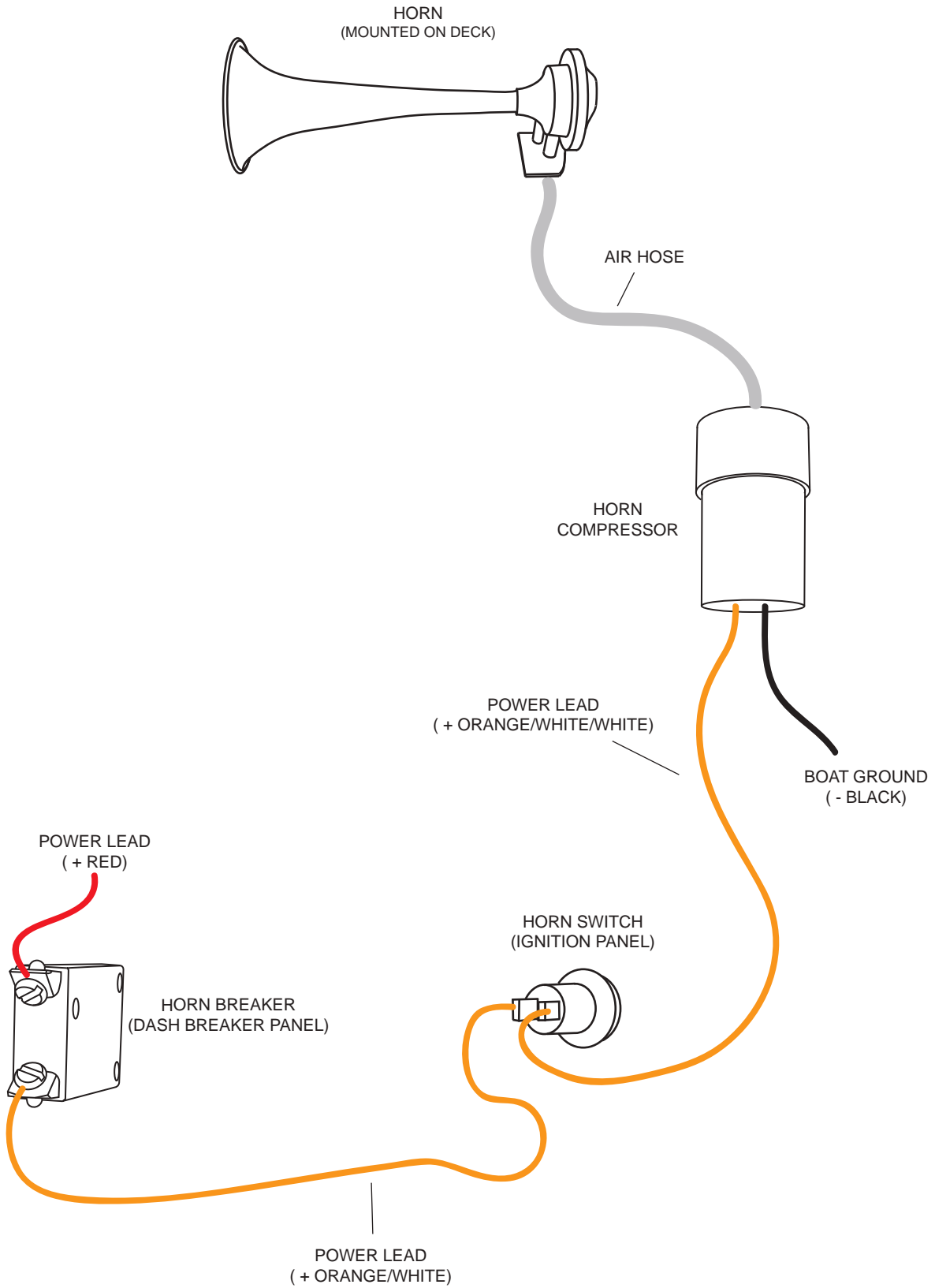

IGNITION

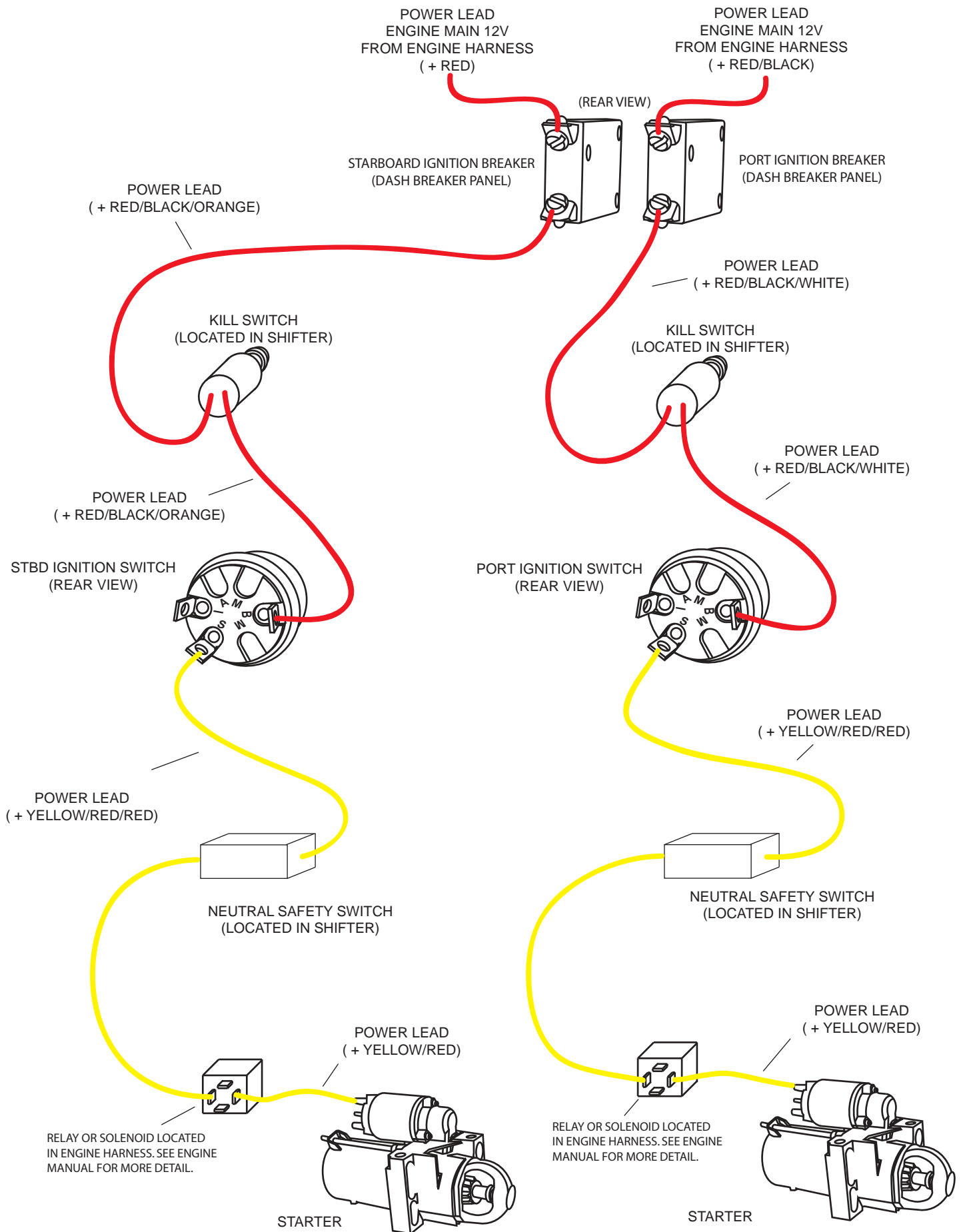

MACERATOR

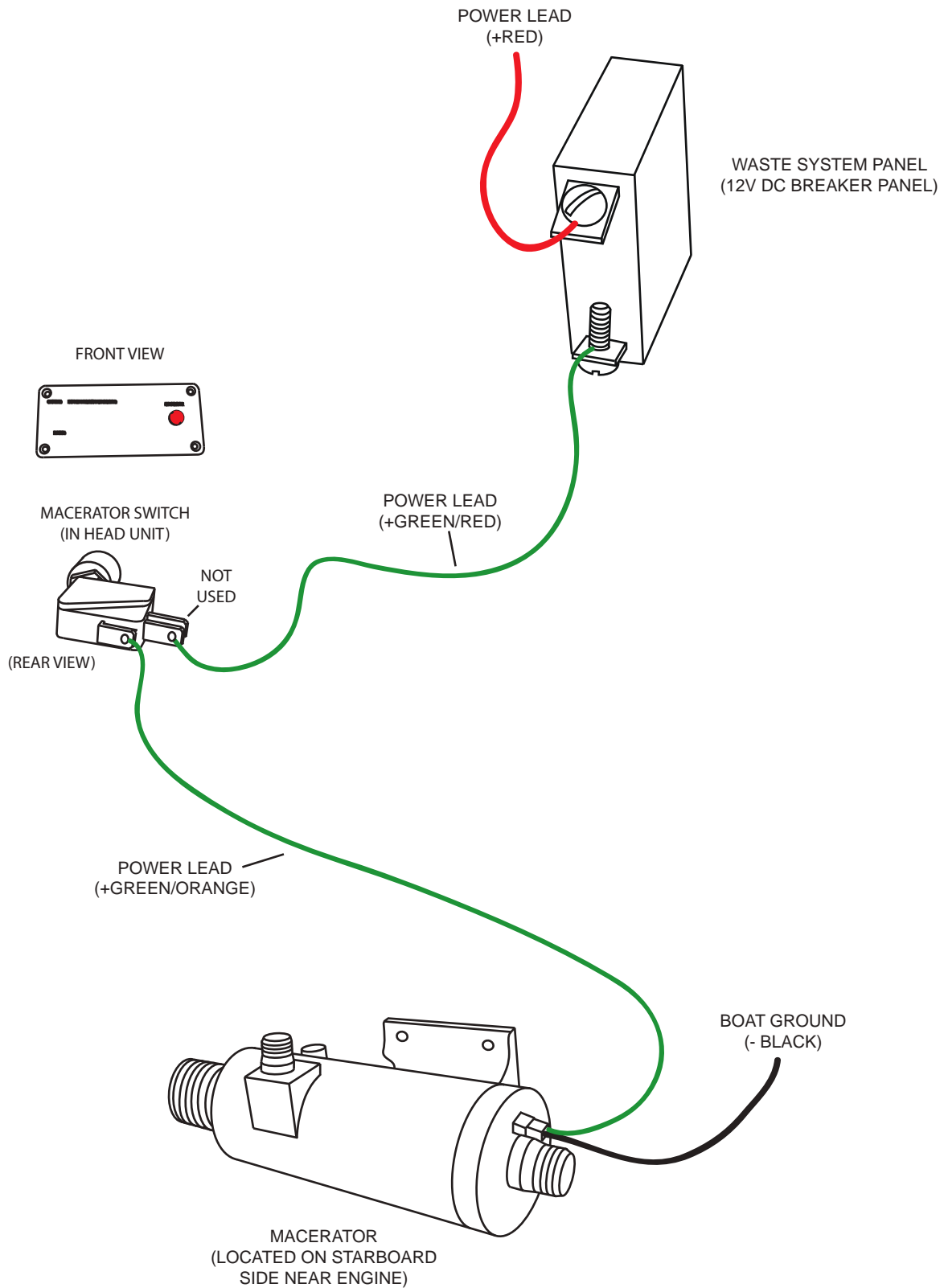

MERCATHODE

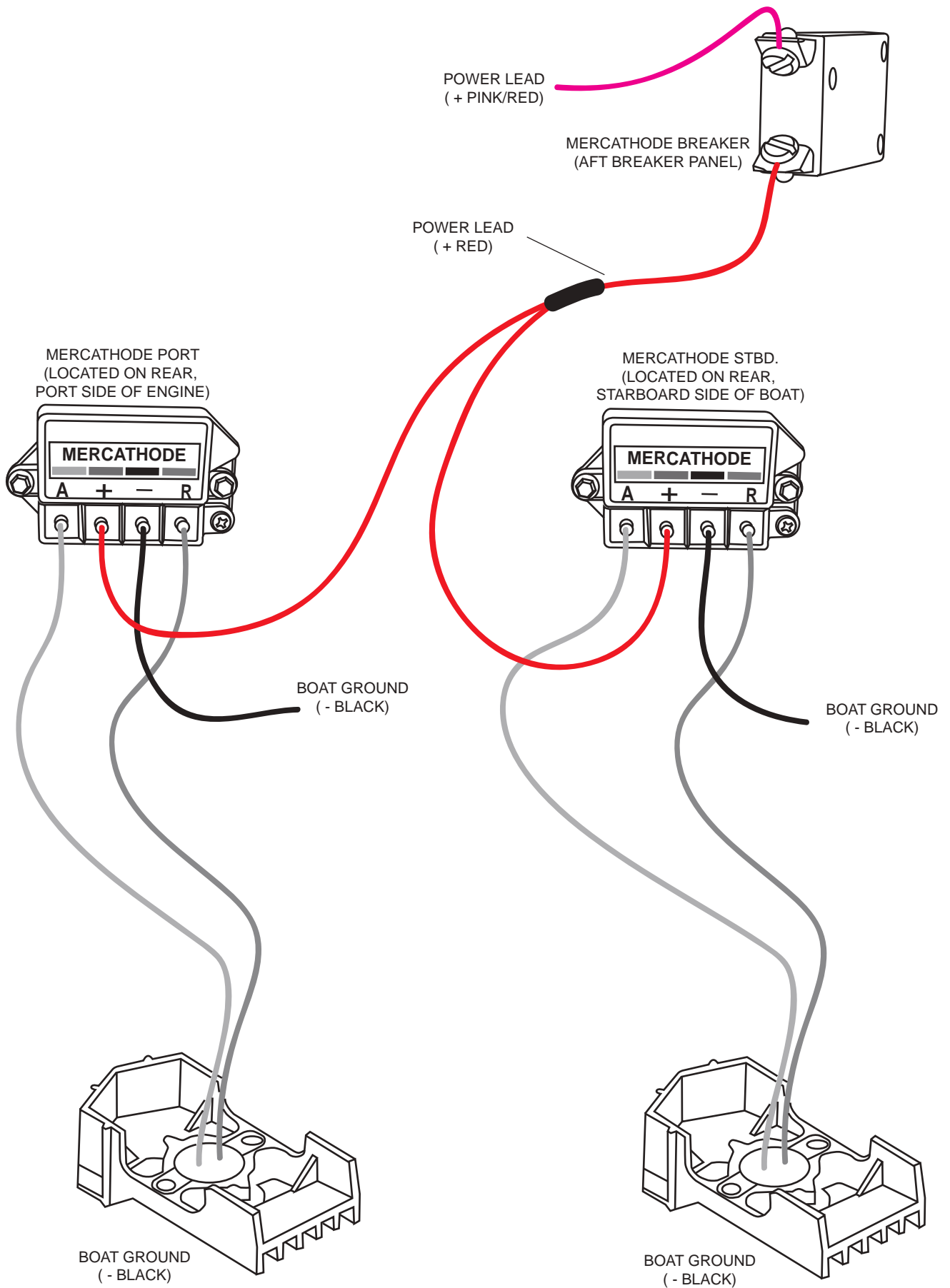

NAVIGATION/ANCHOR LIGHTS

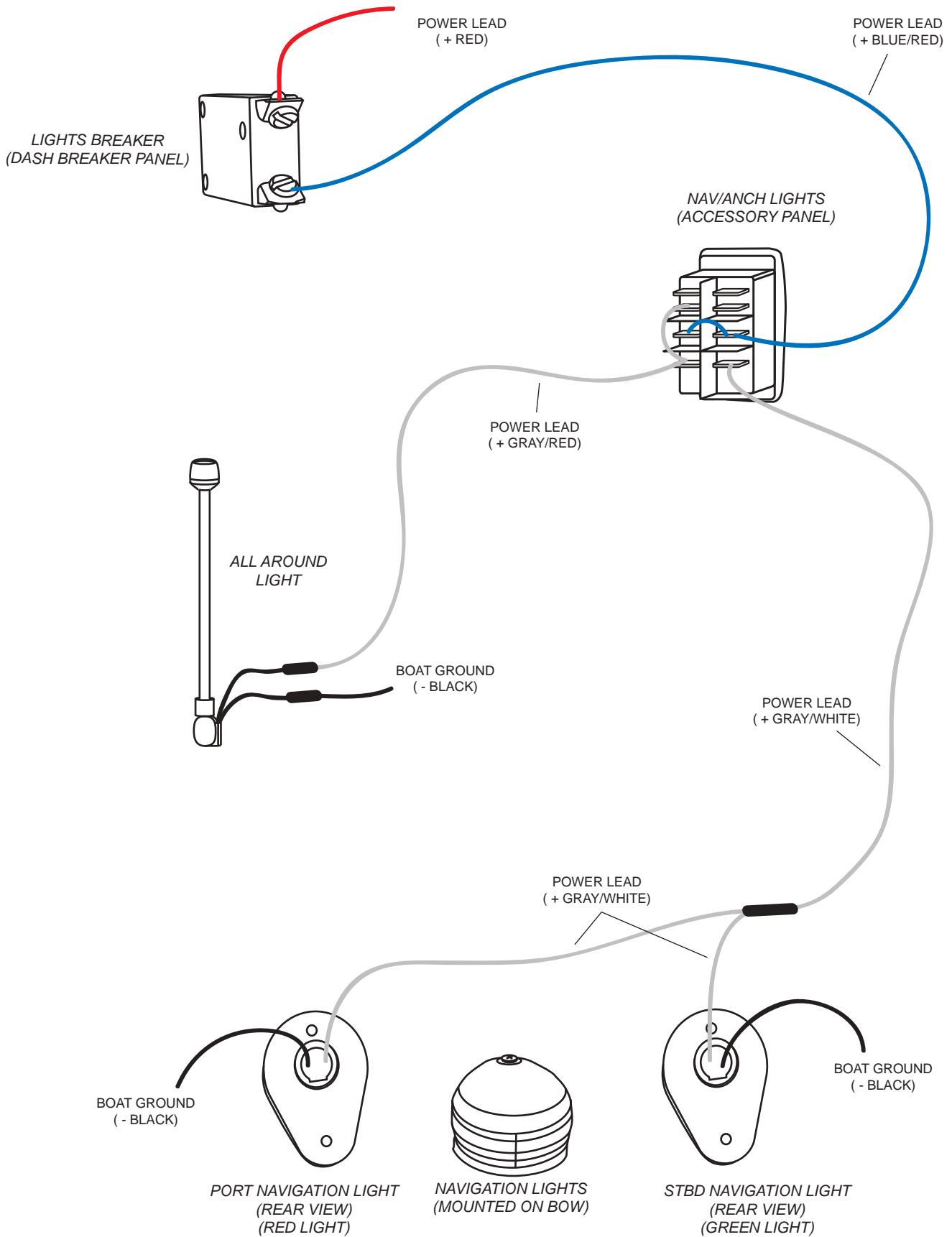

NAVIGATION SYSTEM

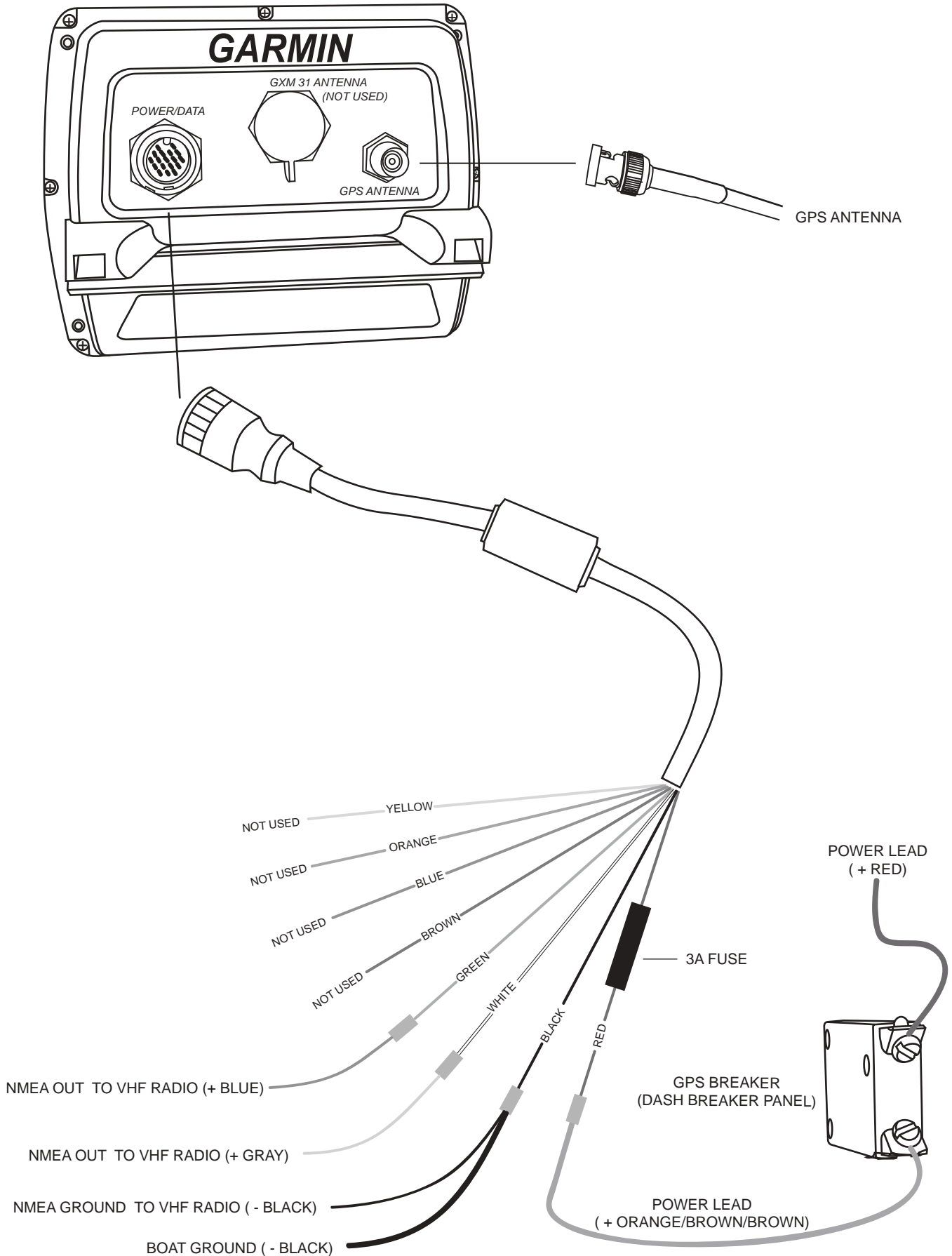

OUTDRIVE PUMP

(MERCURY ENGINES NON SMART CRAFT)

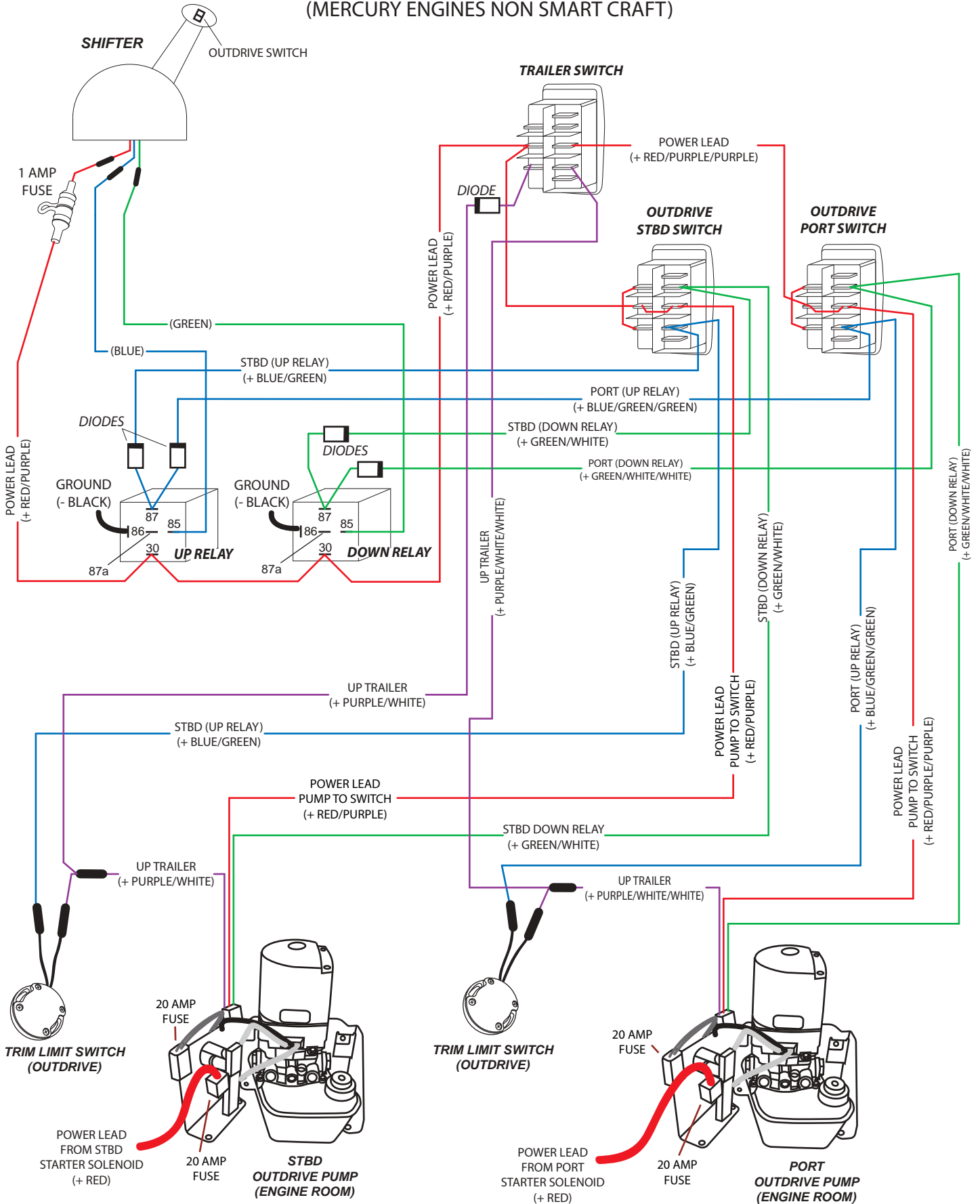

SEAKEY

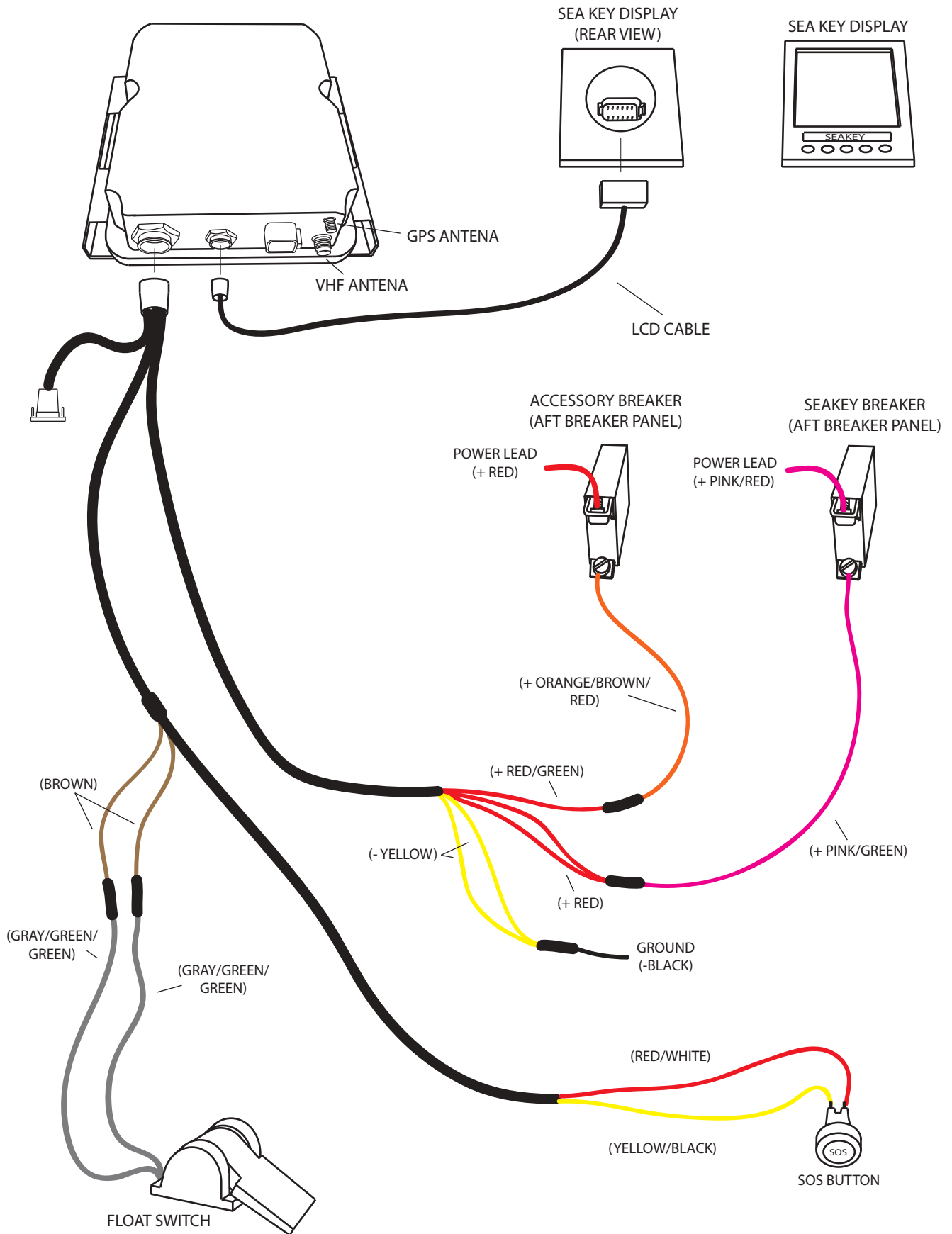

SHOWER SUMP

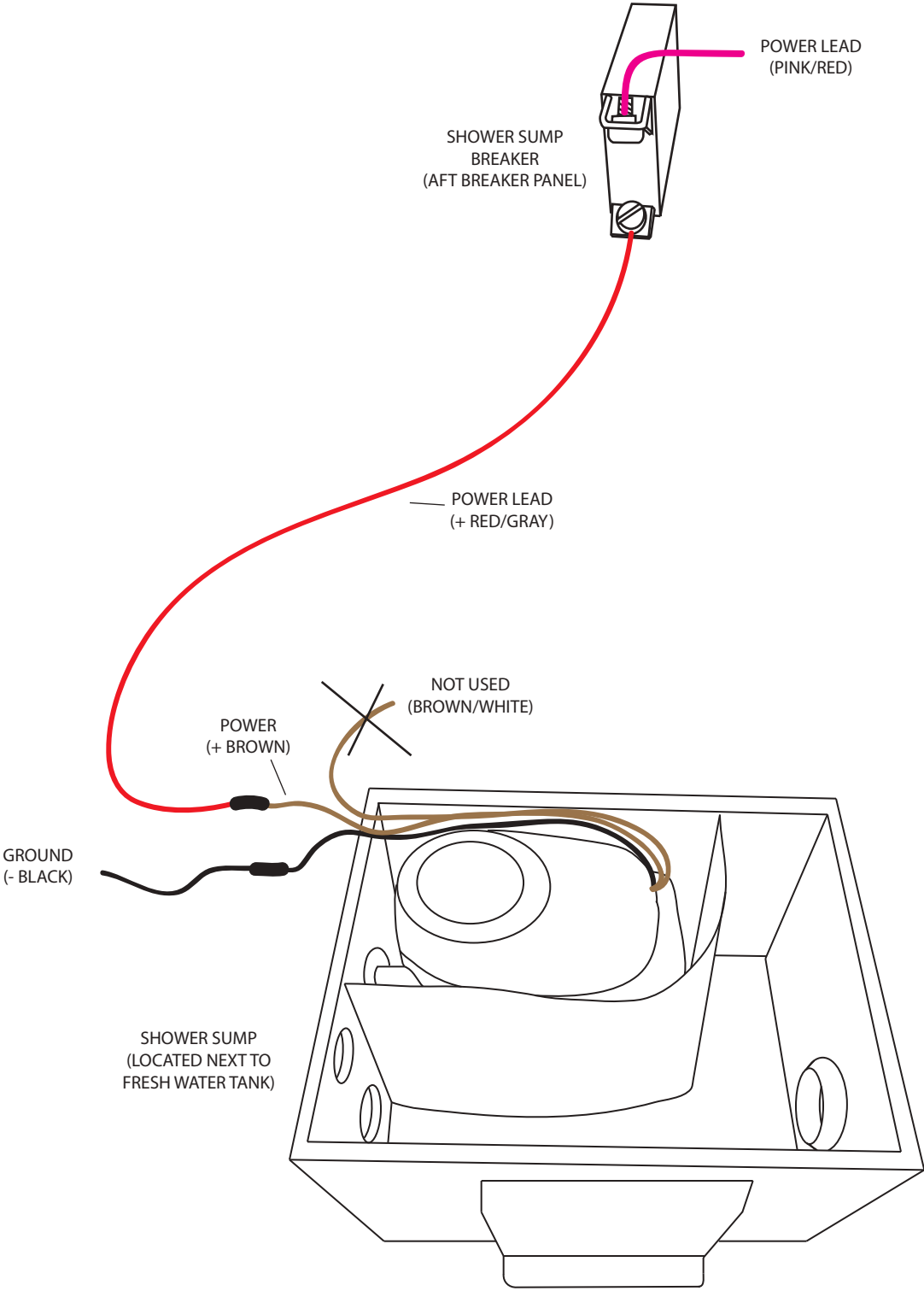

SPOTLIGHT

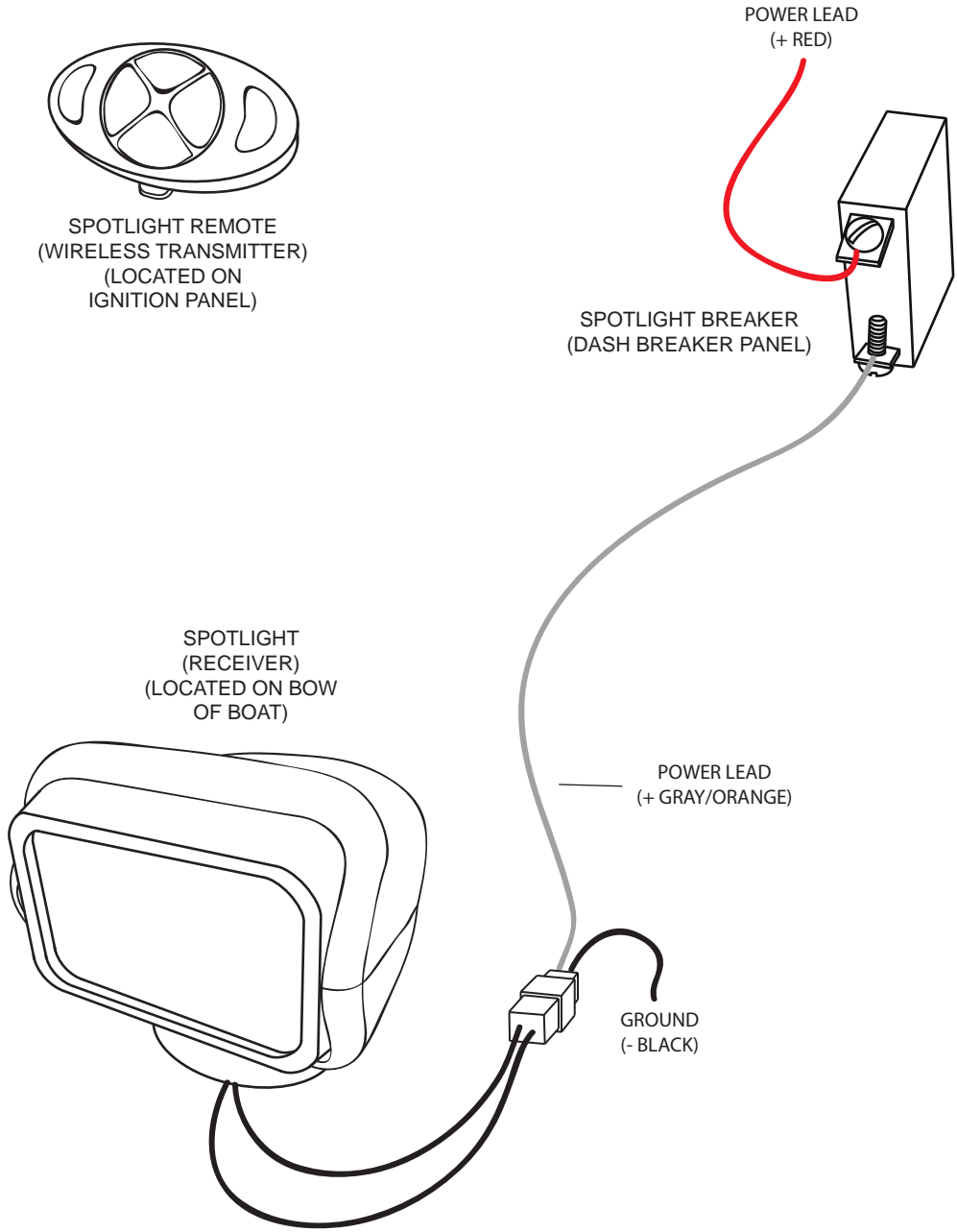

START SOLENOID

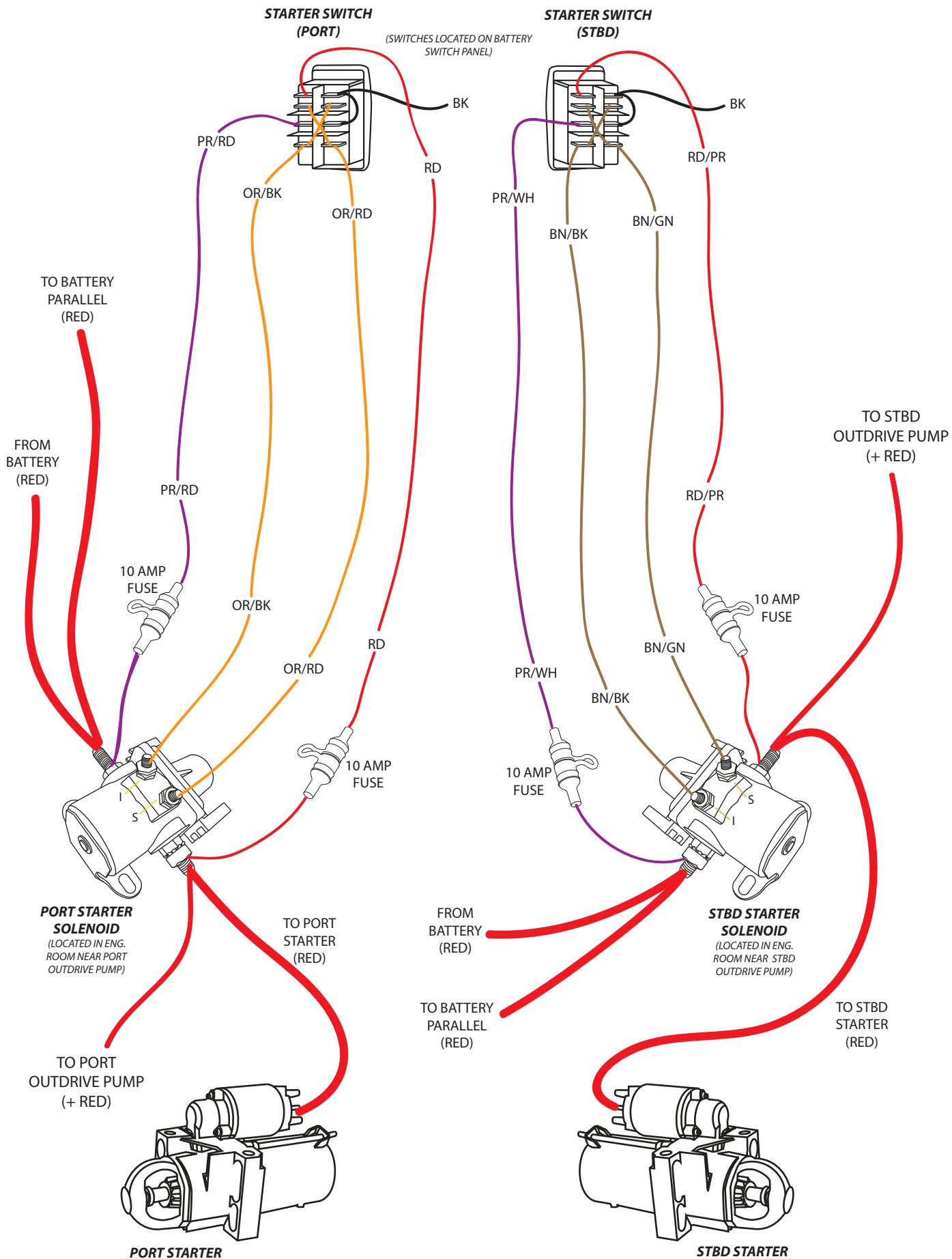

STEREO KENWOOD KTS MP400MR

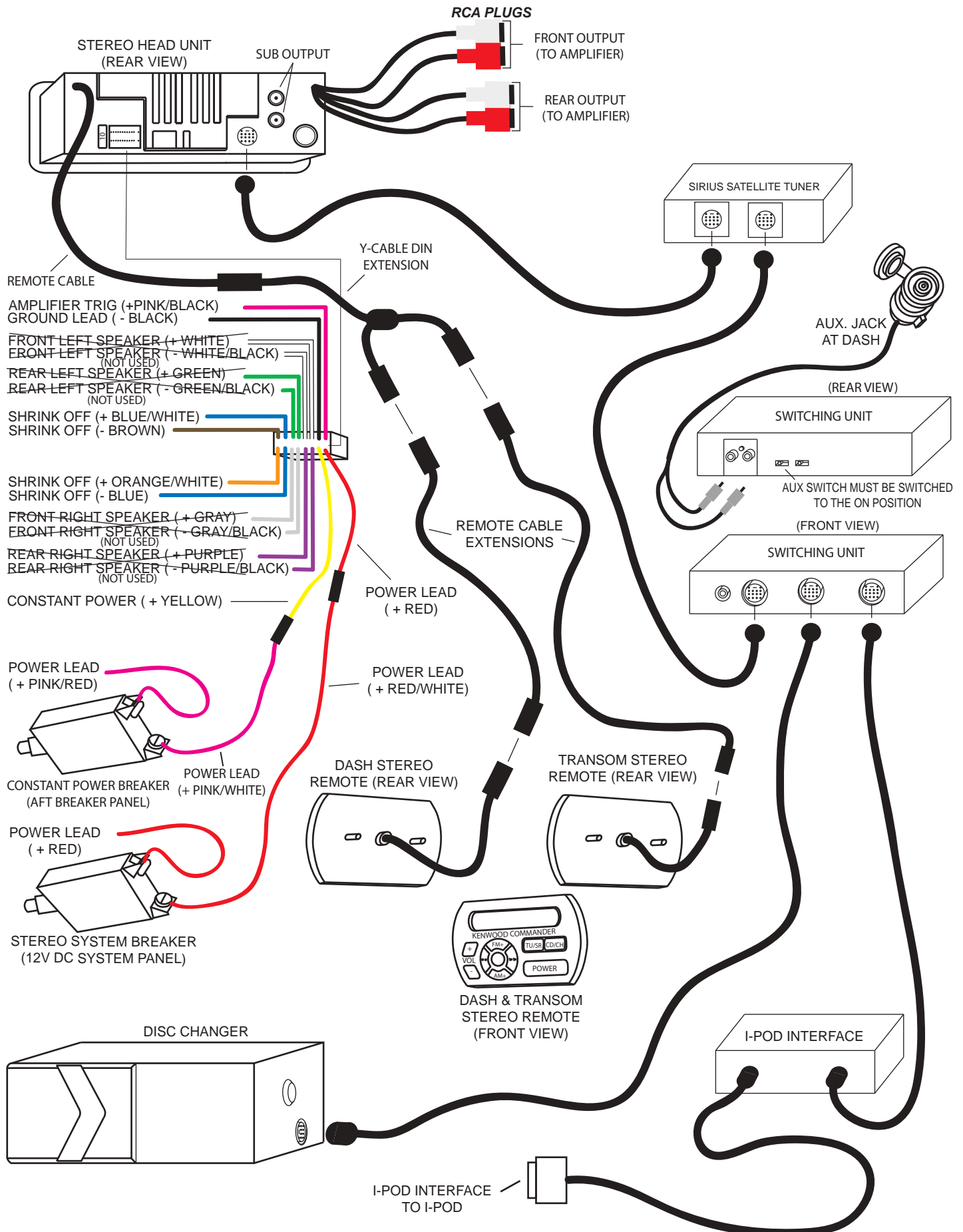

STEREO SYSTEM

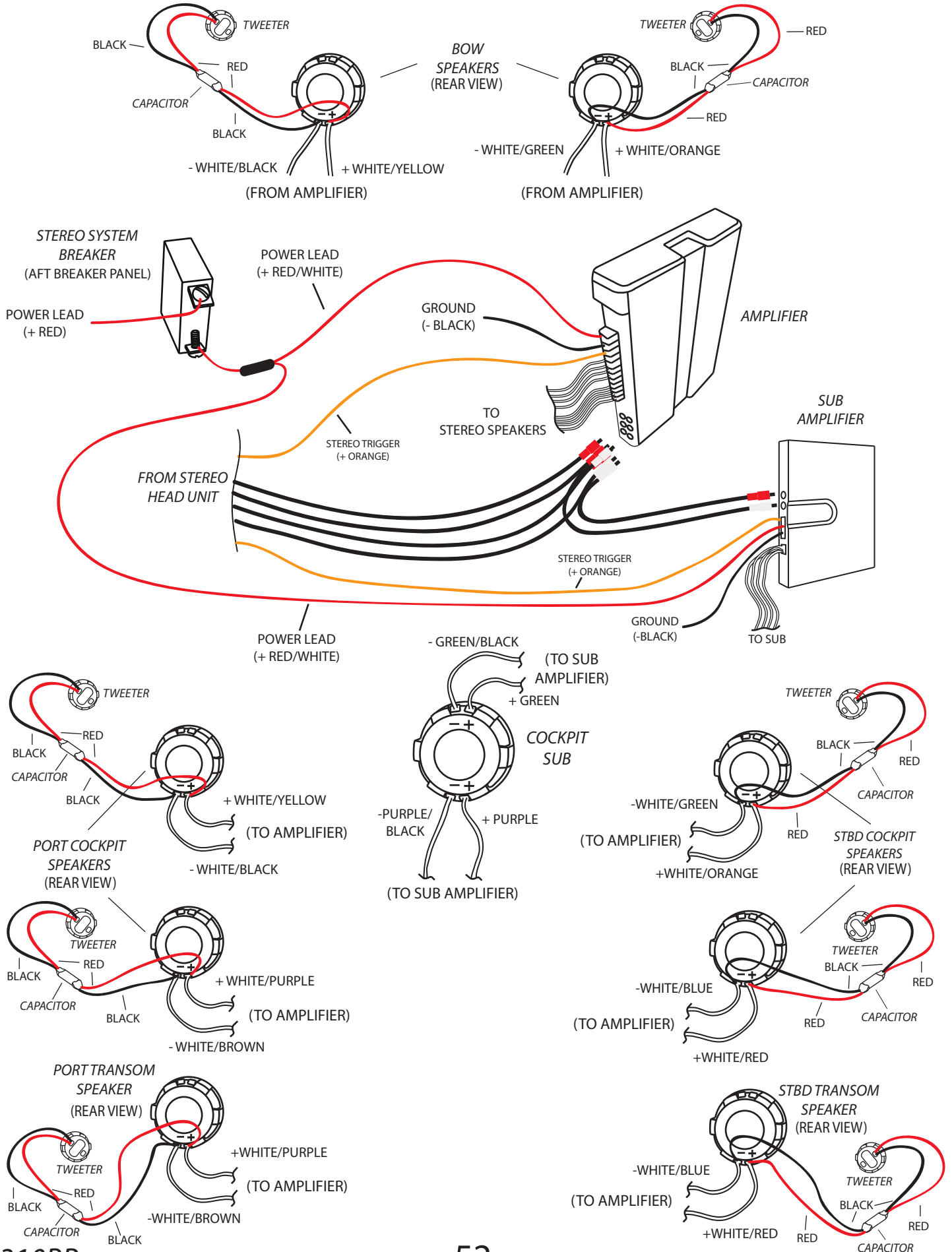

TRIM TAB PUMP

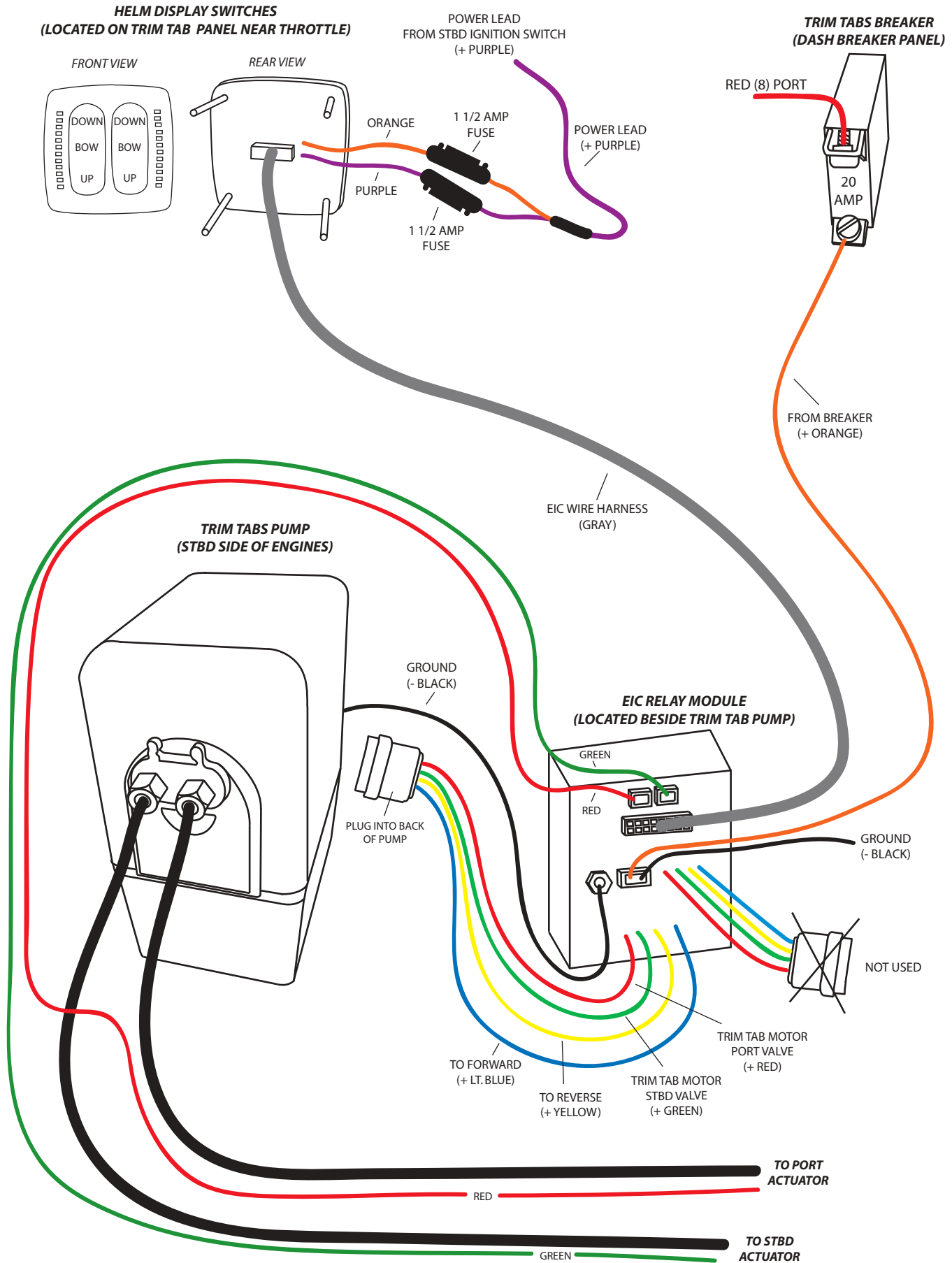

VHF RADIO

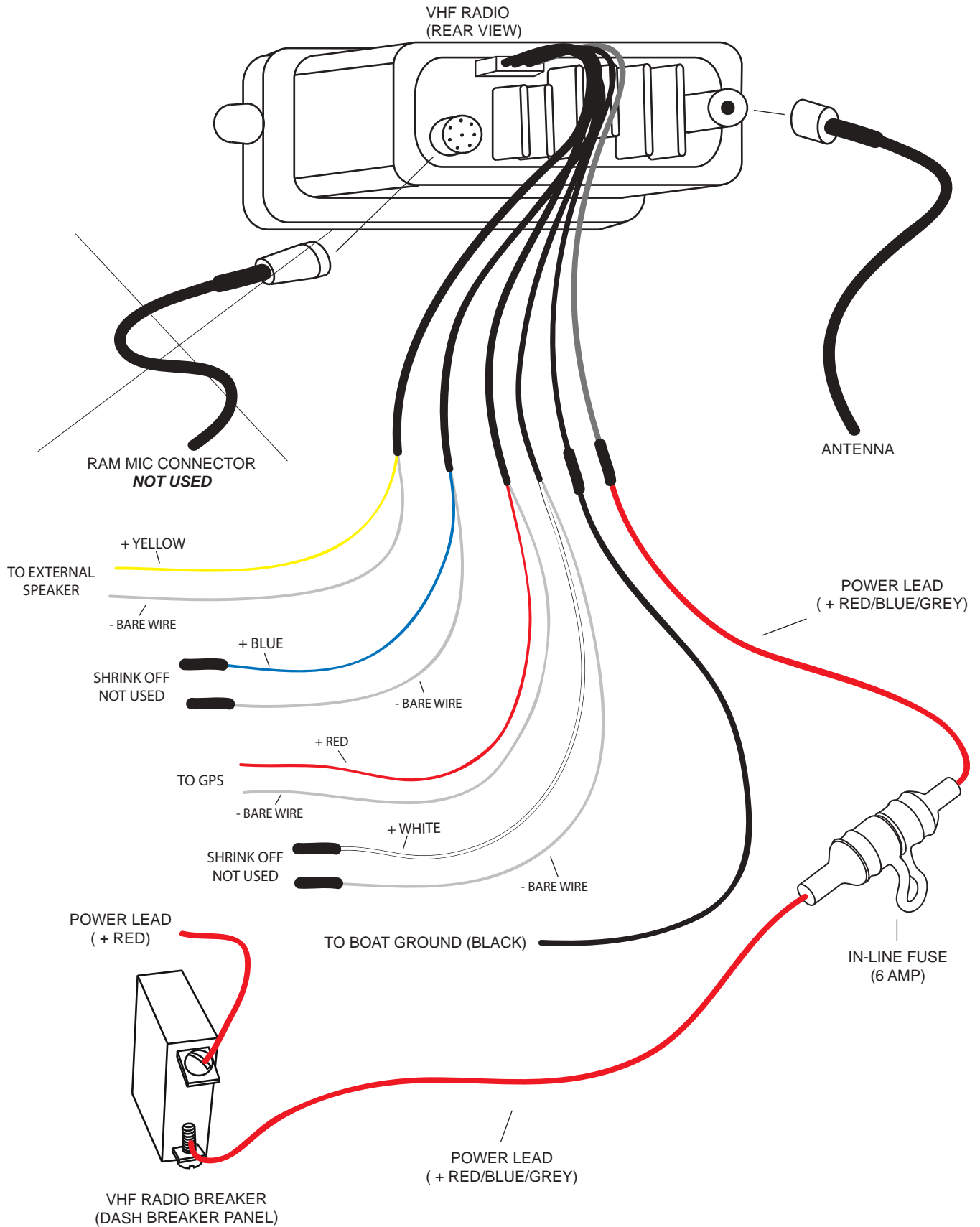

WASTE SYSTEM

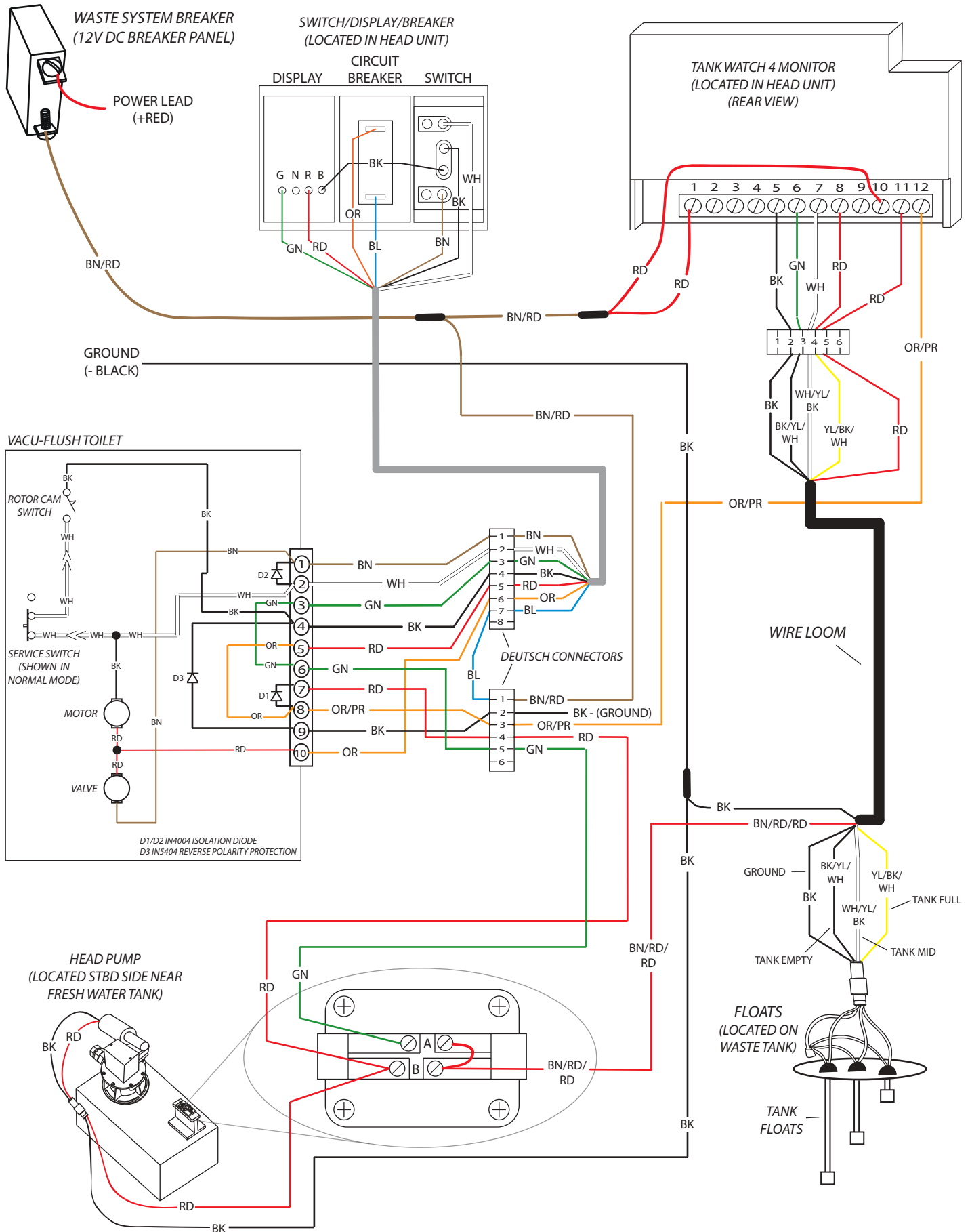

WATER PUMP

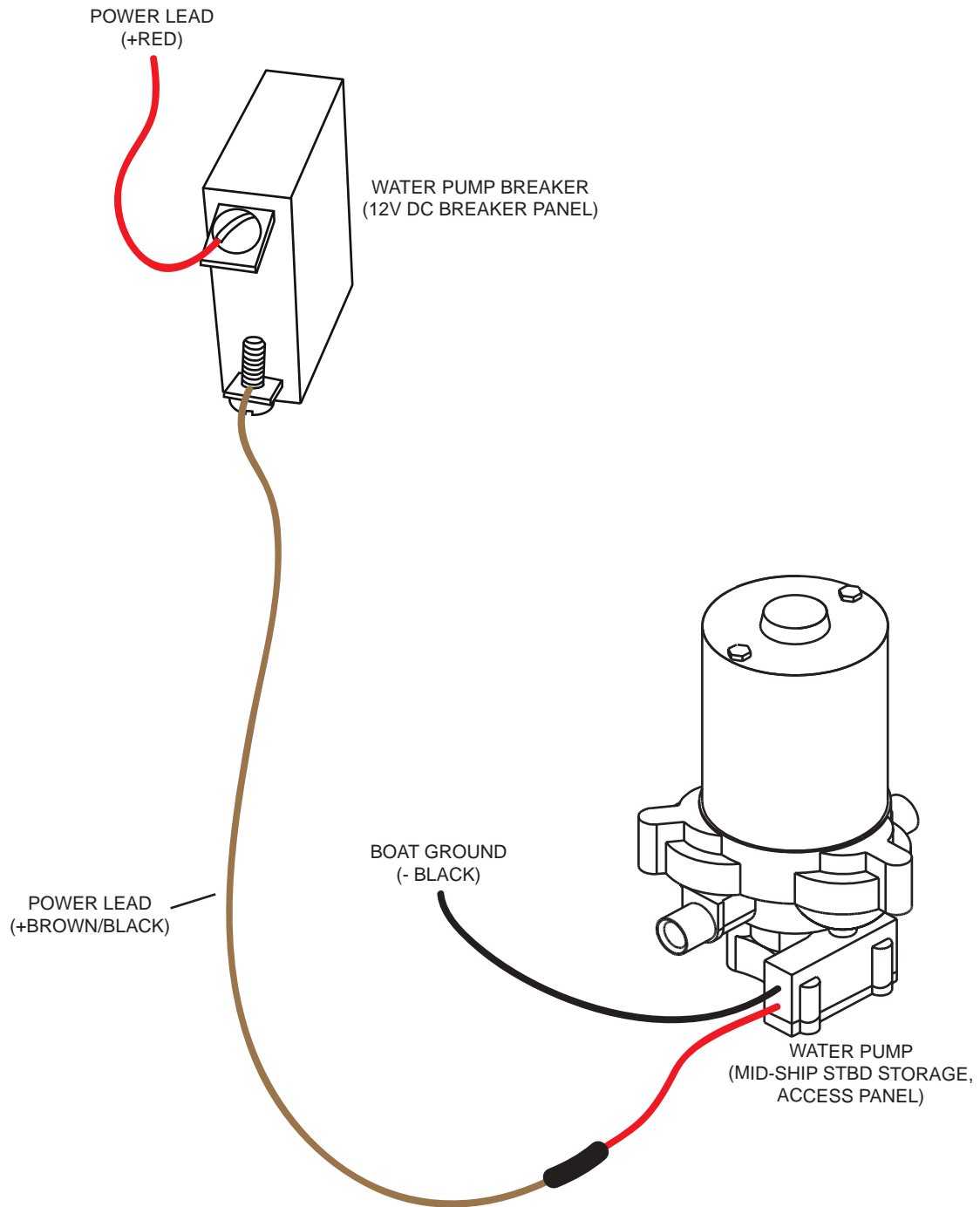

WINDLASS

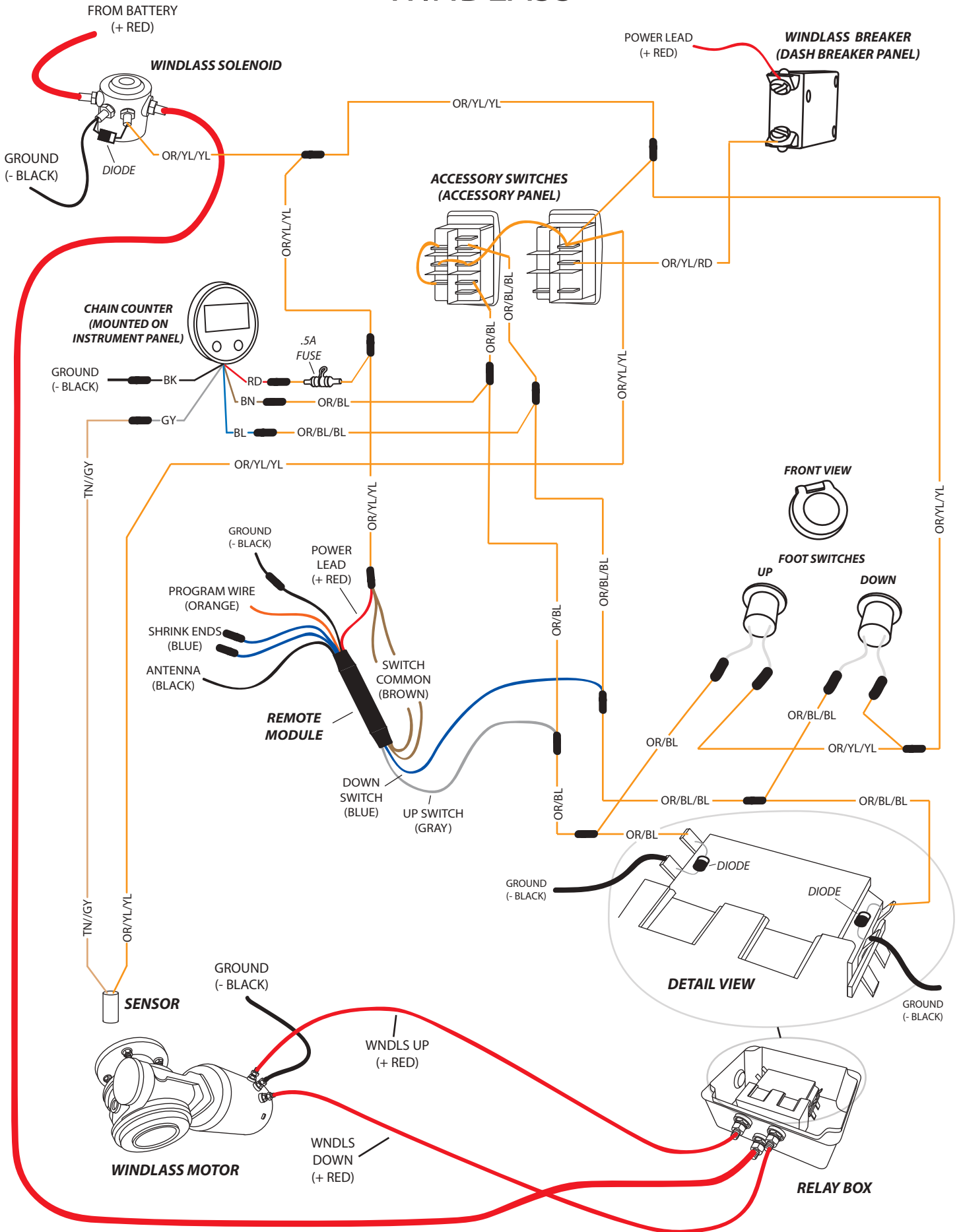

WIPER

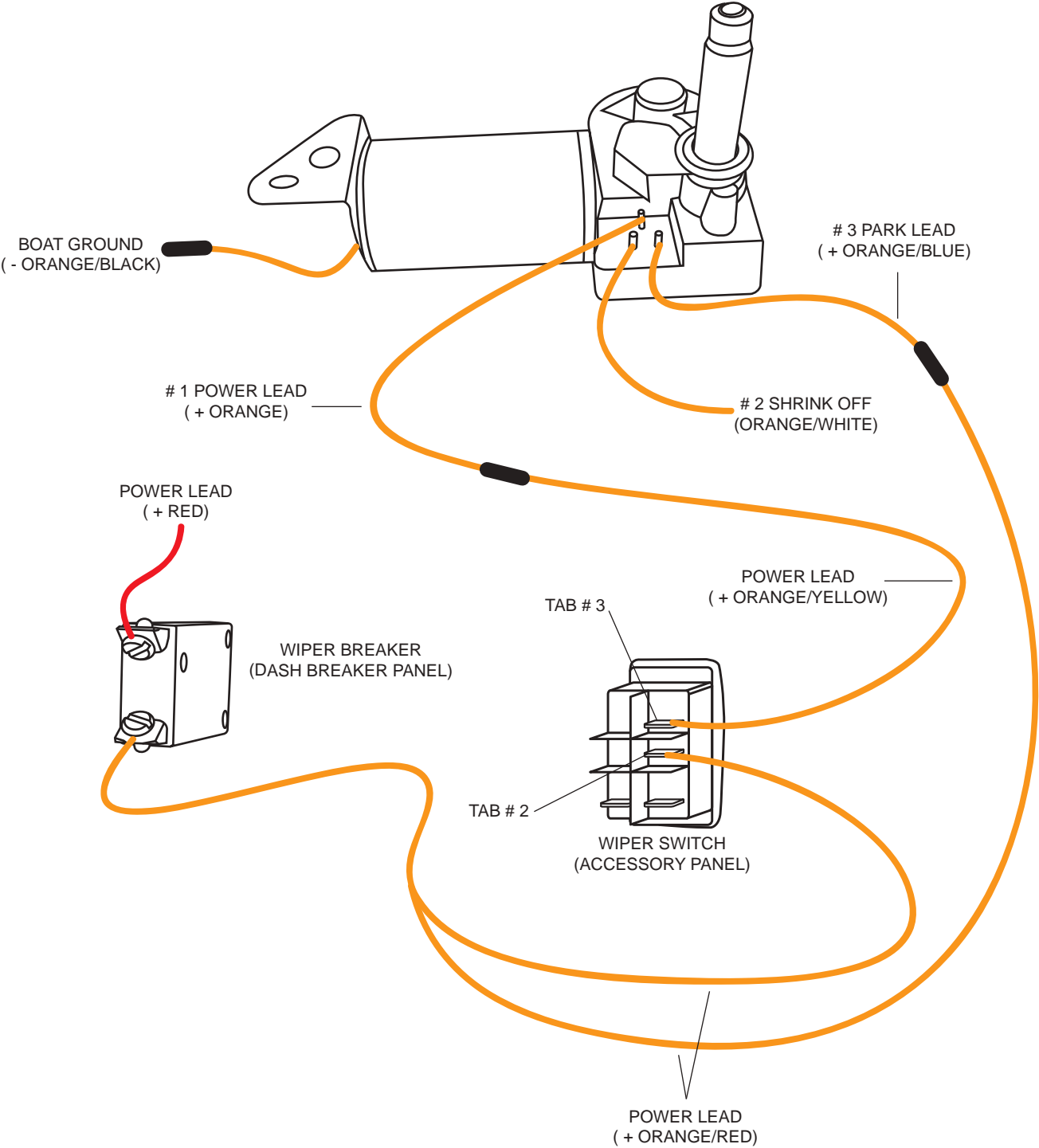

HEAD PUMP PLUMBING

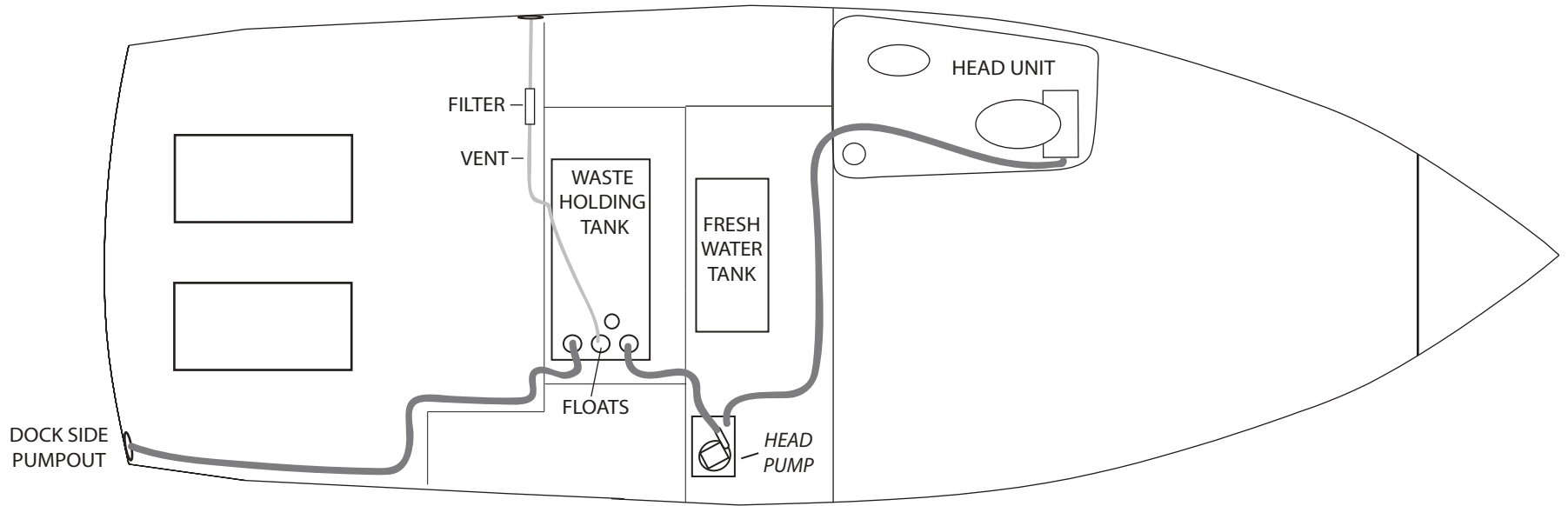

59

HEAD PUMP/MACERATOR PLUMBING

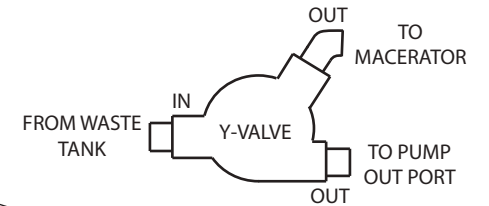
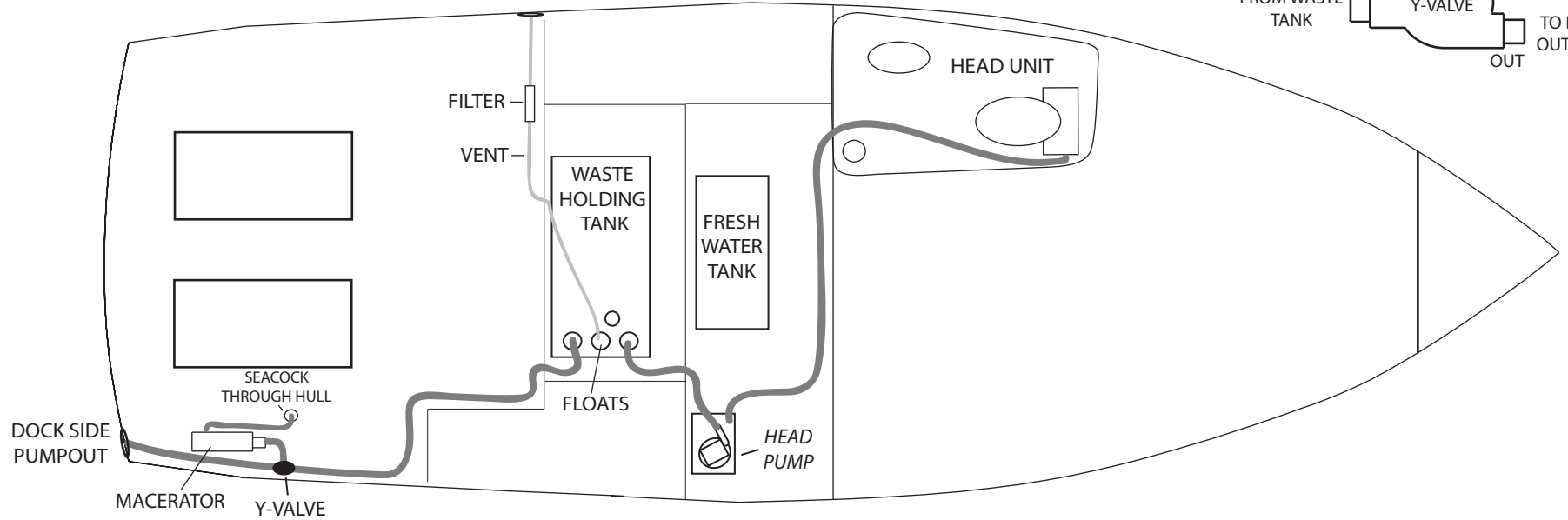

310BR

SHOWER SUMP PLUMBING

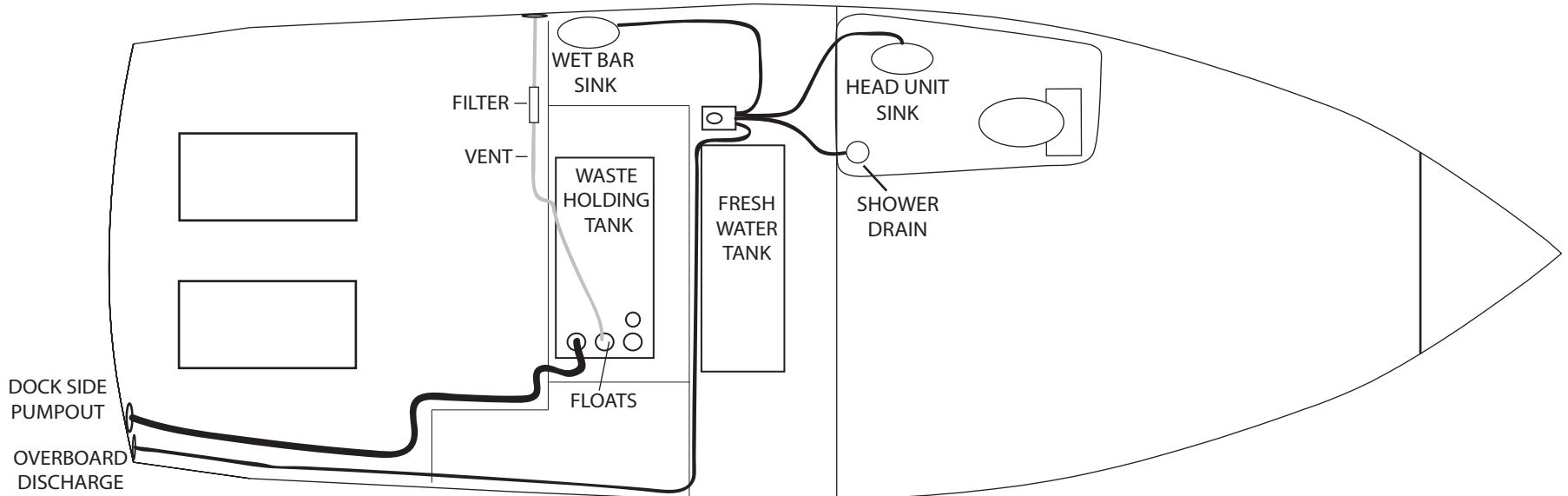

STANDARD BOAT

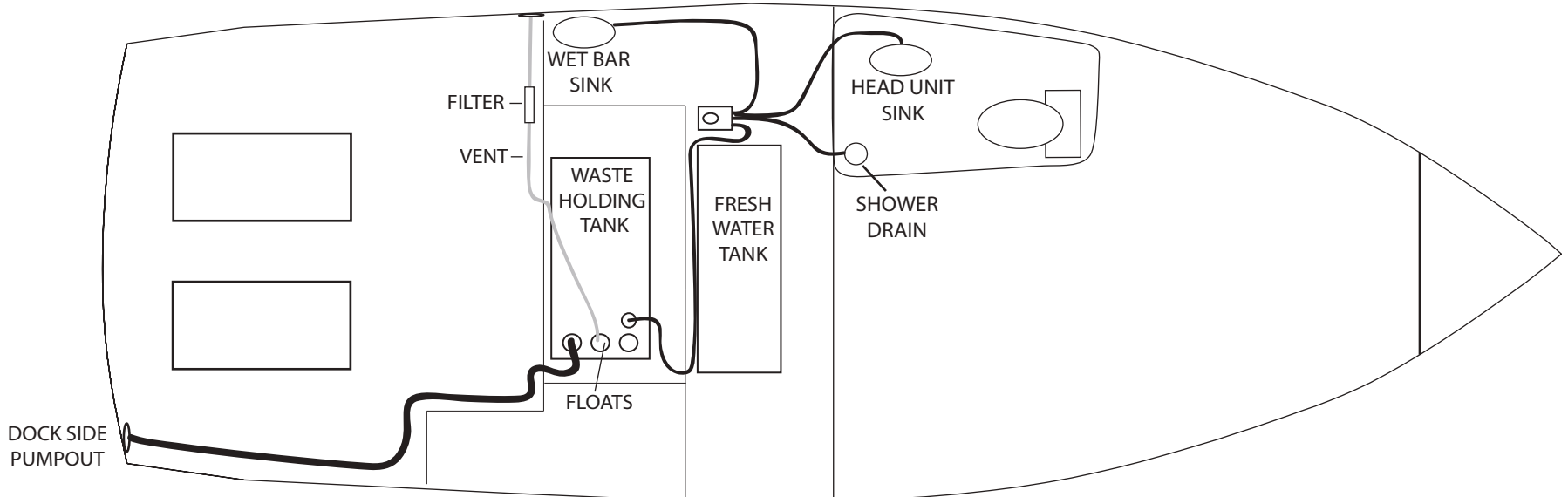

GRAY WATER OPTION

WATER SYSTEM

61

310BR

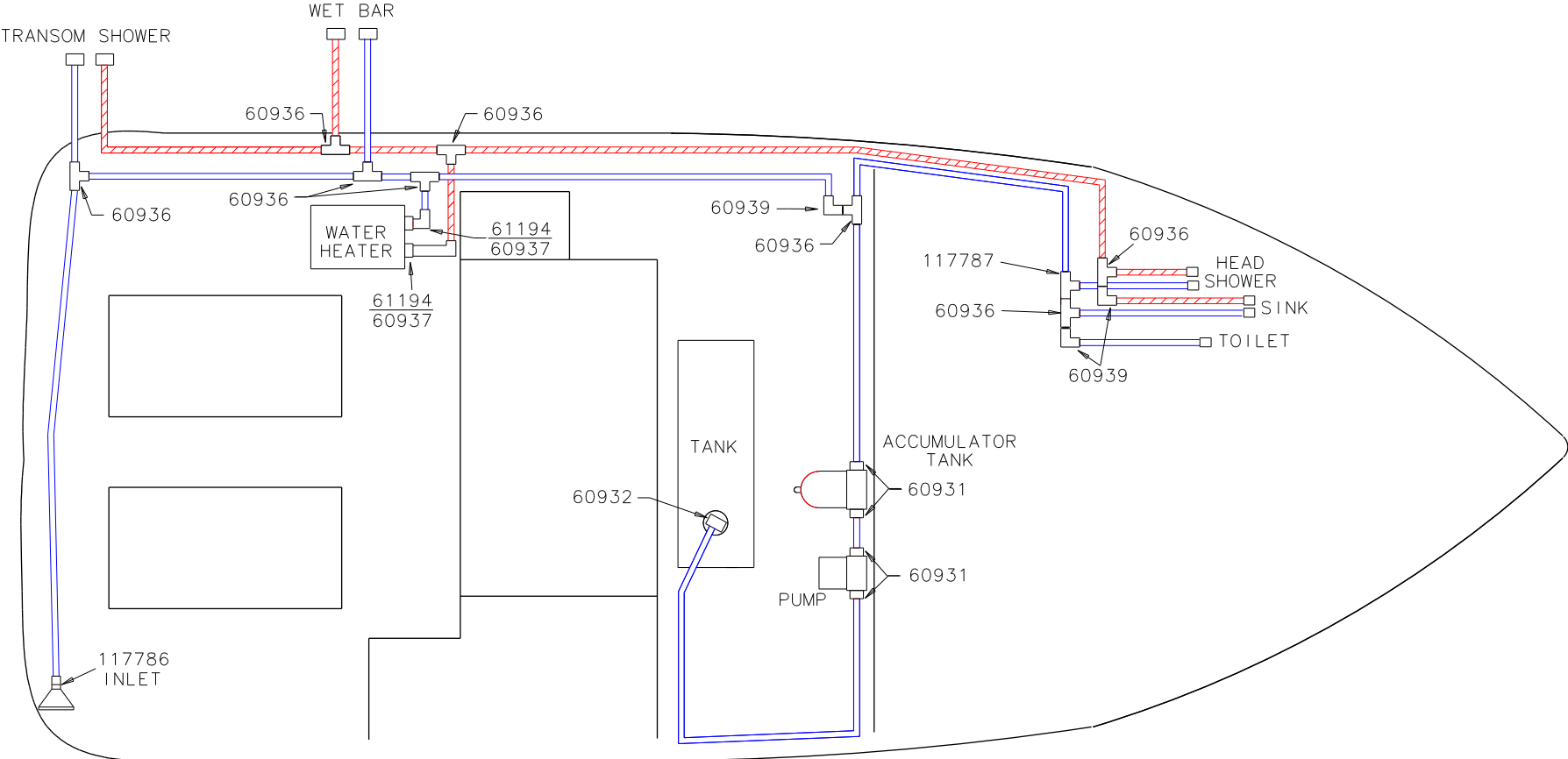

LEGEND	
ALL 15mm WATER LINE	
	HOT
	COLD

FUEL SYSTEM

