

# SUN ODYSSEY 440



## OWNER'S MANUAL



189212 RCD-2  
Index C



<https://www.boat-manuals.com/>



# CONTENTS

<b>INTRODUCTION</b> .....	9
<i>Welcome</i> .....	9
<i>Notes on reading this manual</i> .....	11
<b>1 TECHNICAL SPECIFICATIONS</b> .....	13
<b>1.1 CONSTRUCTION</b> .....	13
<b>1.2 GENERAL DIMENSIONS</b> .....	13
<b>1.3 ENGINE</b> .....	13
<b>1.4 ELECTRICITY</b> .....	14
<b>1.5 CAPACITIES</b> .....	14
<b>1.6 SAILS</b> .....	15
<b>2 DESIGN CATEGORIES AND DISPLACEMENT</b> .....	17
<b>2.1 DEEP DRAUGHT KEEL VERSION</b> .....	17
<b>2.2 SHALLOW DRAUGHT KEEL VERSION</b> .....	17
<b>2.3 DESIGN CATEGORIES</b> .....	20
<b>3 STABILITY AND BUOYANCY</b> .....	21
<b>3.1 STABILITY DATA</b> .....	21
<b>3.2 ACCESS TO THE BOAT</b> .....	22
<b>4 MANOEUVRABILITY</b> .....	25
<b>4.1 VISIBILITY FROM THE STEERING STATION</b> .....	26
<b>5 RIGGING AND SAILS</b> .....	27
<b>5.1 RIGGING DIAGRAM</b> .....	27
5.1.1 <i>Classical mast</i> .....	27
5.1.2 <i>Roller furling mast</i> .....	30
<b>5.2 STANDING RIGGING</b> .....	32
<b>5.3 RUNNING RIGGING</b> .....	34
<b>5.4 SAILS</b> .....	36
<b>5.5 SETTING THE SAILS</b> .....	37
<b>5.6 DECK FITTING</b> .....	42
<b>5.7 WINCHES</b> .....	43
<b>5.8 GENOA FURLER</b> .....	46
<b>5.9 SINGLE LINE FURLER</b> .....	47
<b>6 SAFETY</b> .....	49
<b>6.1 PREVENTING MAN OVERBOARD SITUATIONS AND THE MEANS OF GETTING     SOMEONE BACK ONBOARD</b> .....	49
6.1.1 <i>Prevention of man overboard</i> .....	49
6.1.2 <i>Getting back onboard</i> .....	51

---

6.2	STORING THE LIFE-RAFT .....	53
6.3	SECURING MOVEABLE ITEMS .....	54
6.4	DECK LAYOUT.....	55
6.5	INFORMATION ABOUT THE RISKS OF FLOODING AND ABOUT THE BOAT'S STABILITY	56
6.5.1	Openings in hull .....	56
6.5.2	Drainage system.....	59
6.6	EMERGENCY SYSTEMS IN CASE OF STEERING GEAR FAILURE .....	65
6.7	INFORMATION RELATED TO THE RISKS DUE TO LIGHTNING.....	67
7	INFORMATION RELATING TO FIRE RISKS AND RISKS OF EXPLOSION.....	69
7.1	PROPULSION ENGINES AND OTHER FUEL-BURNING EQUIPMENT.....	69
7.2	ELECTRICAL SYSTEM.....	69
7.3	GAS SYSTEM.....	69
7.4	FIRE-PREVENTION AND FIRE-FIGHTING EQUIPMENT .....	70
7.4.1	Fire-fighting equipment .....	70
7.4.2	Extinguisher access hole (Engine compartment).....	72
7.5	EMERGENCY EXITS IN CASE OF FIRE .....	73
8	ELECTRICAL SYSTEM.....	75
8.1	GENERAL INFORMATION ABOUT THE ELECTRICAL SYSTEM.....	75
8.2	DC INSTALLATION (12 V OR 24 V) .....	76
8.2.1	Battery use and distribution.....	76
8.2.2	Battery switch .....	80
8.2.3	Power distributor.....	82
8.2.4	Battery charger .....	83
8.2.5	Layout of the wiring looms in the hull - DC circuit.....	85
8.2.6	Layout of the deck wiring looms - DC circuit .....	86
8.2.7	Electrical panel .....	87
8.2.8	Circuit breakers .....	88
8.2.9	Fuses .....	89
8.3	TOUCH SCREEN.....	90
8.4	AC SYSTEM (110 V OR 220 V).....	103
8.4.1	General points .....	103
8.4.2	AC shore socket .....	105
8.4.3	AC source selectors.....	107
8.4.4	Layout diagram.....	109
8.4.5	DC/AC converter.....	116
8.4.6	AC breakers .....	118
8.4.7	Installation of hull wiring harnesses - AC circuit.....	119
8.5	PROTECTION AGAINST ELECTROLYSIS / EARTH PLATE .....	120
8.5.1	Anodes .....	120
8.5.2	Earthing plates.....	122

<b>9 LIQUEFIED PETROLEUM GAS (LPG) SYSTEM .....</b>	<b>123</b>
9.1 GENERAL POINTS .....	123
9.2 OPERATION OF THE LPG SYSTEM .....	126
9.3 VERIFICATION OF THE LPG SYSTEM .....	127
9.4 LAYOUT DIAGRAM .....	129
<b>10 DOMESTIC APPLIANCES .....</b>	<b>131</b>
10.1 FRIDGE / COOLER.....	131
10.2 MICROWAVE.....	134
10.3 WASHER.....	135
10.4 BARBECUE (TRANSPORTABLE OUTDOOR COOKER).....	137
<b>11 AUDIO-VISUAL EQUIPMENT .....</b>	<b>141</b>
11.1 TELEVISION .....	141
11.2 HIFI.....	142
<b>12 ONBOARD COMFORT .....</b>	<b>143</b>
12.1 AIR CONDITIONING.....	143
12.2 ELECTRONIC EQUIPMENT.....	150
12.3 EQUIPMENT OTHER THAN FOR PROPULSION, WHICH BURNS FUEL (GENERATOR, HEATING).....	152
12.3.1 General points .....	152
12.3.2 Generator .....	153
12.3.3 Warm air heating system.....	157
<b>13 WATER SYSTEMS.....</b>	<b>163</b>
13.1 GENERAL POINTS.....	163
13.2 USING A VALVE.....	164
13.3 FRESH WATER FILLING SYSTEM .....	165
13.4 FRESH WATER DISTRIBUTION SYSTEM.....	168
13.5 MAIN PLUMBING EQUIPMENT.....	170
13.5.1 Water unit.....	170
13.5.2 Cockpit shower .....	171
13.5.3 Deck wash pump (sea water/fresh water).....	172
13.5.4 Shore freshwater supply .....	174
13.5.5 Sea water/fresh water foot pump.....	175
13.5.6 Water heater .....	176
13.5.7 Water maker.....	177
13.6 BLACK WATER SYSTEM (WC).....	182
13.6.1 Location diagram of black water system.....	182
13.7 WASTE WATER SYSTEM.....	190
13.7.1 Diagram of waste water circuit installation .....	191

---

<b>14 ENGINE.....</b>	<b>193</b>
<b>14.1 INFORMATION ABOUT THE RISKS OF FIRE AND OF EXPLOSION OF ENGINES...</b>	<b>193</b>
<b>14.2 DANGER FROM MOVING MECHANICAL PARTS .....</b>	<b>193</b>
<b>14.3 GENERAL POINTS .....</b>	<b>194</b>
<b>14.4 STARTING THE ENGINE.....</b>	<b>196</b>
<b>14.5 ENGINE WATER INTAKE VALVE.....</b>	<b>197</b>
<b>14.6 ANTI-SIPHON VALVE.....</b>	<b>198</b>
<b>14.7 FUEL FILTER.....</b>	<b>199</b>
<b>14.8 ENGINE INSTALLATION.....</b>	<b>199</b>
<b>14.9 ENGINE CONTROL .....</b>	<b>202</b>
<b>14.10 ACCESS TO THE ENGINE.....</b>	<b>202</b>
<b>14.11 PROPELLER SHAFT.....</b>	<b>203</b>
<b>14.12 STUFFING BOX .....</b>	<b>204</b>
<b>14.13 PROPELLER.....</b>	<b>204</b>
<b>15 STEERING SYSTEM .....</b>	<b>205</b>
<b>15.1 GENERAL POINTS.....</b>	<b>205</b>
<b>15.2 LAYOUT DIAGRAM.....</b>	<b>206</b>
<b>15.3 BOW THRUSTER (RETRACTABLE).....</b>	<b>208</b>
<b>16 DECK FITTINGS.....</b>	<b>211</b>
<b>16.1 GENERAL POINTS.....</b>	<b>211</b>
<b>16.1.1 GRP.....</b>	<b>211</b>
<b>16.1.2 Plexiglas (PMMA).....</b>	<b>211</b>
<b>16.1.3 stainless steel.....</b>	<b>211</b>
<b>16.1.4 Solid wood on exterior wooden panelling .....</b>	<b>211</b>
<b>16.1.5 Exterior upholstery.....</b>	<b>212</b>
<b>16.2 EQUIPMENT.....</b>	<b>213</b>
<b>16.2.1 Electric platform (Rear skirt).....</b>	<b>213</b>
<b>16.2.2 7</b>	
<b>16.3 BERTHING, ANCHORING, TOWING .....</b>	<b>219</b>
<b>16.3.1 Anchor points .....</b>	<b>219</b>
<b>16.3.2 Towing.....</b>	<b>220</b>
<b>16.4 MAIN ELEMENTS OF THE CHAIN LOCKER .....</b>	<b>221</b>
<b>16.5 ELECTRIC WINDLASS.....</b>	<b>222</b>
<b>17 HULL FITTINGS.....</b>	<b>225</b>
<b>17.1 UPHOLSTERY .....</b>	<b>225</b>
<b>17.2 INTERIOR WOODWORK.....</b>	<b>228</b>
<b>17.3 INTERIOR MAINTENANCE .....</b>	<b>229</b>

<b>18 HANDLING, TRANSPORT.....</b>	<b>231</b>
<b>18.1 LIFTING PLAN.....</b>	<b>231</b>
<b>18.2 LIFTING.....</b>	<b>232</b>
<b>18.3 KEEL.....</b>	<b>233</b>
<b>18.4 UPPER LIMIT OF ANTIFOUL.....</b>	<b>234</b>
<b>18.5 LAUNCH/LIFT OUT.....</b>	<b>234</b>
<b>18.6 STEPPING/UNSTEPPING THE MAST.....</b>	<b>234</b>
<b>18.7 WINTER STORAGE.....</b>	<b>235</b>
<b>18.8 TRANSPORT.....</b>	<b>236</b>
<b>19 ENVIRONMENT.....</b>	<b>237</b>
<b>APPENDIXE: MEANING OF THE LABELS.....</b>	<b>239</b>







# INTRODUCTION

## Welcome

You have just taken delivery of your new JEANNEAU boat and we thank you for the confidence you have shown us in ordering a vessel of our brand. The whole JEANNEAU team welcomes you aboard.

A JEANNEAU is made to last, in order to bring you all the pleasure you expect from a vessel over a period of many years. Each boat is subject to the utmost attention to detail from the design stage right through to launching.

This manual is meant to help you to enjoy your boat comfortably and safely. It includes the boat specifications, the equipment provided or installed, the systems and tips on her operation and maintenance. Some of the equipment described in this manual may be optional.

Your JEANNEAU dealer will be able to help and advise you in the use and maintenance of your boat.

The initial commissioning of your boat will require a lot of skill and care. The proper working of all your boat's equipment is the result of the quality of the commissioning operations. This is why the initial launch must be overseen by your dealer.

**Read this Owner's Manual carefully and take the time to get to know your boat before you use it.**

**The better you know your vessel the more pleasure you will get from being at the helm.**

Keep this manual somewhere safe and should you sell your boat, hand it to the new owner.

You are advised to keep any user's guides supplied by the manufacturers of any equipment for your boat (accessories...), together with your manual.



For all the equipment on your boat,  
please read the instruction manuals provided by the manufacturer.

---

■ This manual has been produced to help you enjoy using your boat in all safety. It contains the details of the boat and of all the equipment provided and installed on your boat, as well as the instructions for their use. Read it carefully and really get to know your boat before using it.

■ This owner's manual is not in any way a navigation or mariner's training manual. If this is your first boat or if you have changed to a type of boat with which you are not familiar, make sure that you learn how to use it and manoeuvre it safely and with ease, before taking the helm alone. Your dealer, or national sailing or motorboat association, or your yacht club will be very happy to tell you about the navigation schools or qualified instructors in your area.

■ Make sure that the wind and sea conditions forecast are appropriate for the design category of your boat and that you and your crew are capable of manoeuvring the boat in these conditions.

■ Even with a well-adapted boat, the wind and sea conditions which correspond to the design categories A,B and C range from storm force winds for category A to severe storm conditions at the upper end of category C and would put the boat at risk from massive waves and extreme gusts. These are dangerous conditions in which only an experienced, fit and well-trained crew, manoeuvring a well-maintained boat, could navigate sufficiently well.

■ This owner's manual is not intended as a detailed maintenance or repairs manual. Should any problems arise please contact your dealer. If a maintenance manual is provided, please use it.

■ Always use the services of an experienced professional for the maintenance of your boat, for fitting accessories and for any modifications. Any alterations which may affect the safety specifications of the boat must be assessed, carried out and recorded by persons qualified to do so. The boat manufacturer cannot be held responsible for any modifications not approved by them.

■ Some countries require you to hold a Certificate of Competency or other qualifications, or other specific regulations may be in force.

■ Always maintain your boat well and make note of any deterioration due to wear and tear or to heavy or inappropriate use.

■ Any boat – no matter how well-built – could suffer serious damage if used recklessly. This is not compatible with safe navigation. Always adjust the speed and heading of your boat according to the sea conditions.

■ If your boat is equipped with a life-raft, read the instruction manual carefully. The crew must have available onboard all the safety gear (lifejackets, harnesses etc) appropriate for the type of boat and for the weather conditions etc.. In some countries it is mandatory to have this safety equipment onboard. The crew must be fully familiarised with the use of the safety gear and with emergency manoeuvres (Man Overboard procedures, towing another vessel etc). Sailing schools and clubs regularly run training sessions for these.

■ It is advised that, when on deck, everyone should wear the appropriate buoyancy aids (lifejackets, personal buoyancy aids) Be advised that in some countries, it is mandatory to wear a buoyancy aid which meets the national regulations at all times.



## Notes on reading this manual

The various symbols used throughout the manual for crucial safety information are as follows:



### **DANGER**

Indicates the existence of a serious inherent danger with a high risk of death or serious injury if the appropriate precautions are not taken.



### **WARNING**

Indicates the existence of a danger which could lead to injury or death if the appropriate precautions are not taken.



### **WARNING**

Indicates either a reminder of safety procedures or alerts you to dangerous manoeuvres or operations, which could result in injuries to those onboard or in damage to the boat or to components of it, or to the environment.

### **ADVICE-RECOMMENDATION**

Indicates a recommendation or advice for carrying out manoeuvres appropriate for the planned manoeuvres.

- While some of the information and illustrations in this manual may show details which are slightly different from those found on your boat, the key information remains the same. Future versions of this manual will show any possible modifications as required.
- Due to the constant desire to improve the products, SPBI S.A. reserves the right to make any changes considered necessary to the design or to the equipment. That is the reason why the specifications and information given are not contractual, they may be modified without prior notice or up dates.



- This owner's manual is written in several languages. French is the authentic reference language.
- This owner's manual was written and made up into pages by SPBI S.A.. Any reproduction of this manual, direct or indirect, provisional or permanent, by whatever means this may be, whether in whole or in part, and any modification of this manual by a third party for commercial reasons, are forbidden.





## 1 TECHNICAL SPECIFICATIONS

### 1.1 CONSTRUCTION

Model ..... SUN ODYSSEY 440  
Architect / Interior design ..... Philippe BRIAND / Jean-Marc PIATON  
Builder ..... SPBI S.A  
Principal means of propulsion ..... Sail

Build material:

- Deck ..... Laminated sandwich glass / GRP / Balsa wood or Foam
- Hull ..... Single skin laminated fibreglass / GRP

Application:

- Deck ..... injection
- Hull counter moulding ..... infusion
- Hull ..... Wet laid fiber

### 1.2 GENERAL DIMENSIONS

L.O.A ( $L_{max}$ ):\*

- standard ..... 13,00 m
- with options ..... 13,39 m

*(Including removable parts that can be dismantled (bow roller, pulpit, bowsprit), without affecting the structure of the boat)*

Hull length ( $L_h$ )\* ..... 12,64 m

*(Excluding: removable parts that can be dismantled, without affecting the structure of the boat)*

Overall width ( $B_{max}$ )\* ..... 4,30 m

*(Including: removable parts that can be dismantled, without affecting the structure of the boat)*

Beam ( $B_h$ )\* ..... 4,30 m

*(Excluding: removable parts that can be dismantled, without affecting the structure of the boat)*

Air draft - Empty vessel:

- Classical mast & Roller furling mast ..... 18,9 m
- Mast Performance ..... 20,1 m

Draught - Boat fully laden:

- Deep draught keel version ..... 2,30 m
- Shallow draught keel version ..... 1,70 m

Wetted surface area ..... Approximately 49 m<sup>2</sup>

### 1.3 ENGINE

Nominal maximum propulsion power (at the propeller shaft line) ..... 41,9 Kw

Maximum recommended engine size ..... 236 kg

---

## 1.4 ELECTRICITY

Circuit type:

- Direct current ..... 12 V
- AC ..... 220 V
- AC (US Version) ..... 110 V

## 1.5 CAPACITIES

Total mass of the liquid content of fixed tanks when they are full.....802 kg

*NOTE: The density of a liquid can vary according to its temperature and quality.*

*The volume masses chosen are:*

- 0,86 kg/L for diesel fuel,
- 1 kg/L for water.

Fuel capacity:

- Tank (\*): .....200 L
- Extra tank (\*): .....200 L

Fresh water capacity:

- Tank 1 (\*): .....330 L
- Tank 2 (\*): .....200 L

Black water capacity (WC):

- Tank 1 (\*): .....50 L
- Tank 2 (\*): .....50 L

It may not be possible to use these capacities fully depending on the trim and load of the boat.  
It is recommended to keep a reserve of 20% in the fuel tanks.

*(\*): Refer to the corresponding chapter to locate the position of the tank (relationship between the tank number and its position on board).*



## 1.6 SAILS

I: Distance between deck and highest genoa halyard sheave:

- Standard mast ..... 15,30 m
- Mast Performance ..... 16,50 m

J: Distance between the fore of the mast and the bow fitting on the deck:

- Standard mast ..... 5,17 m
- Mast Performance ..... 5,17 m

P: Length of the mainsail luff:

- Standard mast ..... 15,30 m
- Mast Performance ..... 16,50 m

E: Length of the mainsail foot:

- Standard mast ..... 5,05 m
- Mast Performance ..... 5,05 m

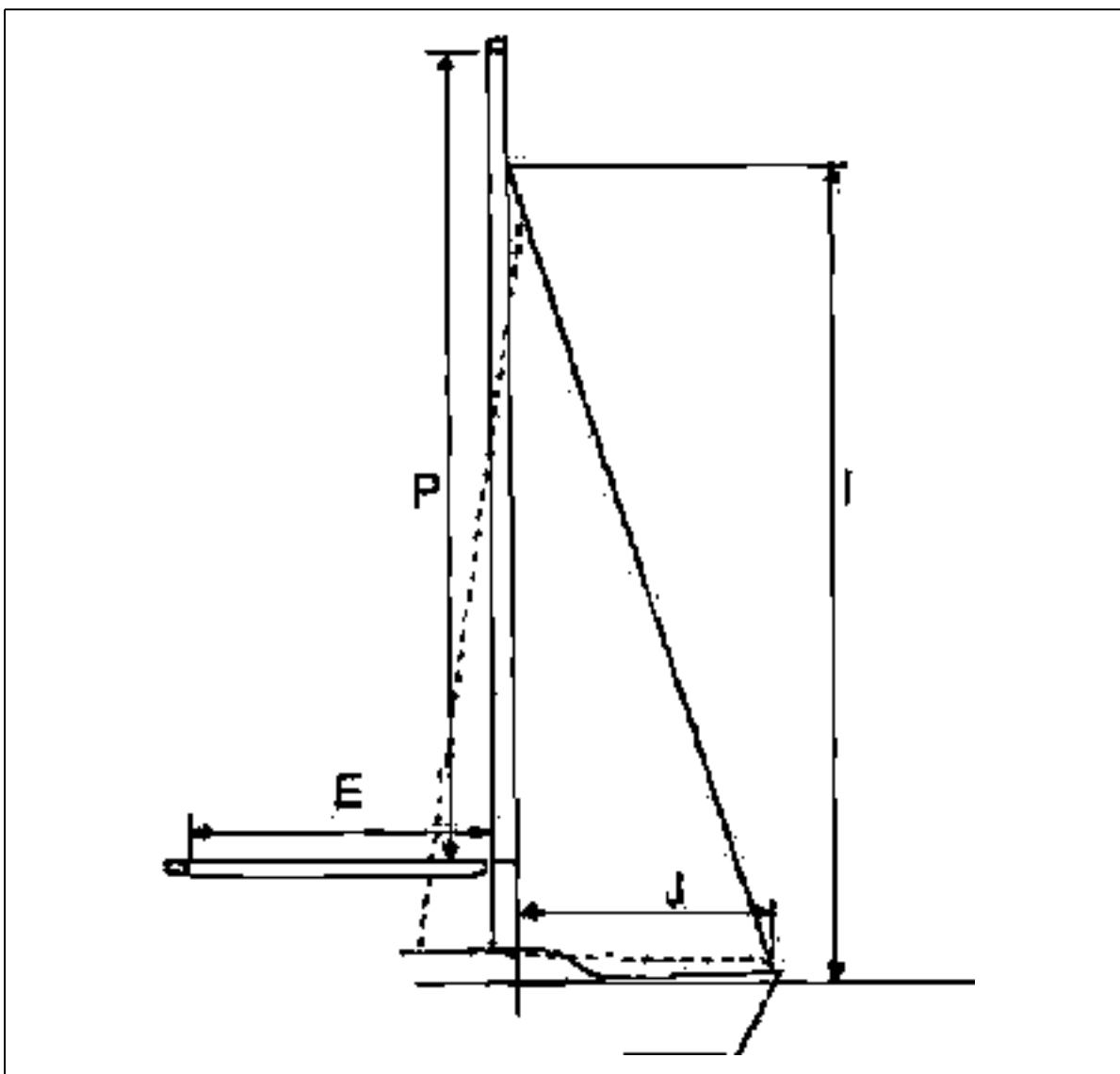

---

Mainsail Performance .....	49,22 m <sup>2</sup>
Classic mainsail .....	45,15 m <sup>2</sup>
Furling mainsail.....	35,17 m <sup>2</sup>
Genoa Performance.....	49,15 m <sup>2</sup>
Furling genoa .....	45,40 m <sup>2</sup>
Self-tacking jib.....	32,54 m <sup>2</sup>
Asymmetrical spinnaker:	
- Standard mast.....	140 m <sup>2</sup>
- Mast Performance.....	160 m <sup>2</sup>
Code 0 .....	89,90 m <sup>2</sup>
Planned sail area*:	
- Standard mast.....	78,18 m <sup>2</sup>
- Mast Performance.....	84,31 m <sup>2</sup>

*\* Definition: designated by (AS) and calculated as the sum of the projected surfaces in profile of all sails that can be established when the vessel is close hauling, on the booms, horns, bowsprits or other spars, and the surface of fore triangle(s) to the most advanced forestay, fixed permanently during operation of the vessel with the mast bearing the established sails, without overlap, assuming that the jackstays and leeches are straight lines.*

*The surface of the spars is not included in the projected calculation sail plan area, with the exception of the wing-masts.*





## 2 DESIGN CATEGORIES AND DISPLACEMENT

- Some of the data is shown on the manufacturer's plate fixed to the boat. The explanation of the data is given in the appropriate chapters of this manual.

**NOTE: The on-board fitted options are included in the maximum load. The more options the boat has, the less room there is for provisions or personal belongings.**

### Definition:

\* **CL:** Crew Limit

\*\* **MLC:** Mass of the boat in Light Craft Condition

includes the weight of the boat in the standard ready-to-navigate version, ballast, standard equipment, engine(s), sails (if the boat is a sailing boat).

\*\*\* **ML:** Maximum Load

- The recommended maximum load includes the weight of all the people onboard, of provisions, personal belongings, of all equipment not included in the weight of the boat in ballast, of the cargo (if relevant) and of all liquids contained in fixed tanks when full (fuel, water, grey water, black water).

- The maximum recommended weight shown on the manufacturer's plate does not include the weight contained in the fixed tanks of liquid when full (fuel, water, grey water, black water).

\*\*\*\* **MLDC:** Mass of the boat in Maximum Load Condition

Includes light ship mass MLC + maximum load ML.

### 2.1 2 CABINS LAYOUT

#### 2.1.1 Deep draught keel version

Design category	A	B	C	D
Maximum number of people to be allowed onboard (CL)*	6	7	12	14
Light displacement (MLC)**	9 281 kg			
Recommended maximum load (ML)***	3 260 kg	3 260 kg	3 540 kg	3 630 kg
Displacement with maximum load (MLDC)****	12 541 kg	12 541 kg	12 821 kg	12 911 kg

#### 2.1.2 Shallow draught keel version

Design category	A	B	C	D
Maximum number of people to be allowed onboard (CL)*	6	7	12	14
Light displacement (MLC)**	9 651 kg			
Recommended maximum load (ML)***	3 260 kg	3 260 kg	3 540 kg	3 630 kg
Displacement with maximum load (MLDC)****	12 911 kg	12 911 kg	13 191 kg	13 281 kg

---

## 2.2 3 CABINS LAYOUT

### 2.2.1 Deep draught keel version

Design category	A	B	C	D
Maximum number of people to be allowed onboard (CL)*	8	9	14	16
Light displacement (MLC)**	9 403 kg			
Recommended maximum load (ML)***	3 500 kg	3 500 kg	3 700 kg	3 770 kg
Displacement with maximum load (MLDC)****	12 903 kg	12 903 kg	13 103 kg	13 173 kg

### 2.2.2 Shallow draught keel version

Design category	A	B	C	D
Maximum number of people to be allowed onboard (CL)*	8	9	14	16
Light displacement (MLC)**	9 773 kg			
Recommended maximum load (ML)***	3 500 kg	3 500 kg	3 700 kg	3 770 kg
Displacement with maximum load (MLDC)****	13 273 kg	13 273 kg	13 473 kg	13 543 kg

## 2.3 4 CABINS LAYOUT

### 2.3.1 Deep draught keel version

Design category	A	B	C	D
Maximum number of people to be allowed onboard (CL)*	10	11	16	18
Light displacement (MLC)**	9 349 kg			
Recommended maximum load (ML)***	3 600 kg	3 600 kg	3 710 kg	3 780 kg
Displacement with maximum load (MLDC)****	12 949 kg	12 949 kg	13 059 kg	13 139 kg

### 2.3.2 Shallow draught keel version

Design category	A	B	C	D
Maximum number of people to be allowed onboard (CL)*	10	11	16	18
Light displacement (MLC)**	9 719 kg			
Recommended maximum load (ML)***	3 600 kg	3 600 kg	3 710 kg	3 780 kg
Displacement with maximum load (MLDC)****	13 319 kg	13 319 kg	13 429 kg	13 499 kg



If some of those onboard are children, the total number of people allowed onboard may be increased, provided that:

- The total weight of the children does not exceed 37,5 kg;
- and that
- the total weight of all allowed onboard (based on about 75 kg per adult) is not exceeded.



- Do not exceed the recommended maximum number of people onboard. However many people are onboard, the total, combined load of people and any gear or equipment must never exceed the recommended maximum load.
- Always use the seats or seating areas provided.



- When loading the boat, never exceed the recommended maximum load. Always load the boat with care and distribute the loads in order to maintain the theoretical trim (more or less horizontal).
- Avoid placing heavy loads high up in the boat.

---

## 2.4 DESIGN CATEGORIES

### Category A:

A yacht of design category A is considered to be designed for wind that may exceed force 8 (on the Beaufort scale) and waves that can exceed a significant height of 4 metres, but excluding exceptional conditions such as storms, severe storms, tornadoes and extreme sea conditions or huge waves.

### Category B:

A yacht of design category B is considered to be designed for wind that may go up to force 8 inclusive and waves that can reach a significant height up to 4 metres inclusive.

### Category C:

A yacht of design category C is considered to be designed for wind that may go up to force 6 inclusive and waves that can reach a significant height up to 2 metres inclusive.

### Category D:

A yacht of design category D is considered to be designed for wind that may go up to force 4 inclusive and waves that can reach a significant height up to 0,3 metres inclusive, with occasional waves of a maximum height of 0,5 metres.

***NOTE: Boats in each category must be designed and built to withstand these parameters in respect of stability, buoyancy, and other relevant essential requirements and to have good handling characteristics.***



## 3 STABILITY AND BUOYANCY

### 3.1 STABILITY DATA

- Fully laden displacement was used to evaluate the stability and buoyancy of the boat. The value of this displacement can be found in paragraph "Technical specifications" at the beginning of this manual.
- Any changes in the distribution of loads onboard (for example by adding a raised structure for fishing, fitting a radar or in-mast furling, changing the engine etc.) can significantly affect the boat's stability, trim and its performance;
- It is important to keep water in the bilges to a minimum;
- The boat's stability is affected by adding to the weight of the superstructure;
- In heavy weather it is important to close all the hatches, lockers and doors to minimise the risk of water pouring in;
- The boat's stability can be reduced when towing a boat or when using a davit or boom to lift a heavy load;
- Breaking waves are a serious threat to stability.



- Reduce speed in waves.
- Always adjust the speed and heading of your boat according to the sea conditions.
- All of the watertight hatches must remain closed when at sea.
- Beyond 20 knots of Wind, you are advised to stow all removable protection sheets (Lazy-bag, Bimini, Covers...).

---

## 3.2 ACCESS TO THE BOAT

### Access to the cockpit



***NOTE: It is essential that the guardrail is closed when sailing.***

### Access to companionway



**Access cut**



**Access to the engine compartment**



---

## Access to the marine cabin / sail locker



- It is imperative that both the cockpit and the engine compartment are kept closed when at sea.
- When at sea close the guardrail side-opening or openings.
- Slamming an access hatch may cause injury : always close the hatch gently and carefully.
- Do not allow children to open or close the hatches unsupervised.



- It is imperative that companionway access is kept closed when at sea.
- Close the deck hatches and portholes before each trip.
- Close all access doors and hatches in heavy weather or when the sea is rough.

### ADVICE-RECOMMENDATION

- When under way, keep hull valves and fillers in the closed position to minimise the risk of flooding.





## 4 MANOEUVRABILITY

- This boat was tested using the stability rating STIX, which is a worldwide safety measurement of stability and which takes account of the length of the vessel, its displacement, hull dimensions, stability characteristics and flooding proofness. This test produced the following results:

### Shallow draught version (Shallow draught keel)

	Boat with minimal load	Boat with maximum load
Angle of vanishing stability (in degrees)	115°	111°
STIX	39	38

### Deep draught version (Deep draught keel)

	Boat with minimal load	Boat with maximum load
Angle of vanishing stability (in degrees)	115°	111°
STIX	40	38

- This boat is liable to capsize or to become flooded if carrying too much sail. In these circumstances it could sink. It is important to reduce the sail area if the wind exceeds force 3 on the scale of Beaufort. It is important to be especially vigilant in strong gusts of wind or in a squall.

- Take extra precautions if sailing downwind when you come round onto a beam reach, as both the apparent wind and the angle of heel will increase. Such changes to the point of sail must not be made at speed and you should first consider reducing sail.



- If carrying too much sail, the boat could capsize.
- It is important to take additional precautions in very strong winds or in a confused sea or breaking waves.

---

## 4.1 VISIBILITY FROM THE STEERING STATION

The vision of the helmsman from the steering station can be obstructed when under sail caused by one or several variable conditions:

- 1) Load and load distribution;
- 2) Speed;
- 3) Sea conditions;
- 4) Rain and mist;
- 5) Darkness and fog;
- 6) Lights inside the boat;
- 7) Position of covers and curtains;
- 8) Persons or mobile equipment located in the helmsman's field of view.

List of sails able to obstruct a forward view:

- All except the staysail.

The international regulations to avoid collisions at sea (Col Reg / RIPAM) and rules require appropriate and continuous watching as well as the observance of the right-of-way rules. Observance of these rules is essential.



- Manoeuvrability is reduced at excessive speeds.
- There is a risk of loss of control during tight turns.
- Reduce speed before making a turn in any direction.



## 5 RIGGING AND SAILS

### 5.1 RIGGING DIAGRAM

#### 5.1.1 Classical mast

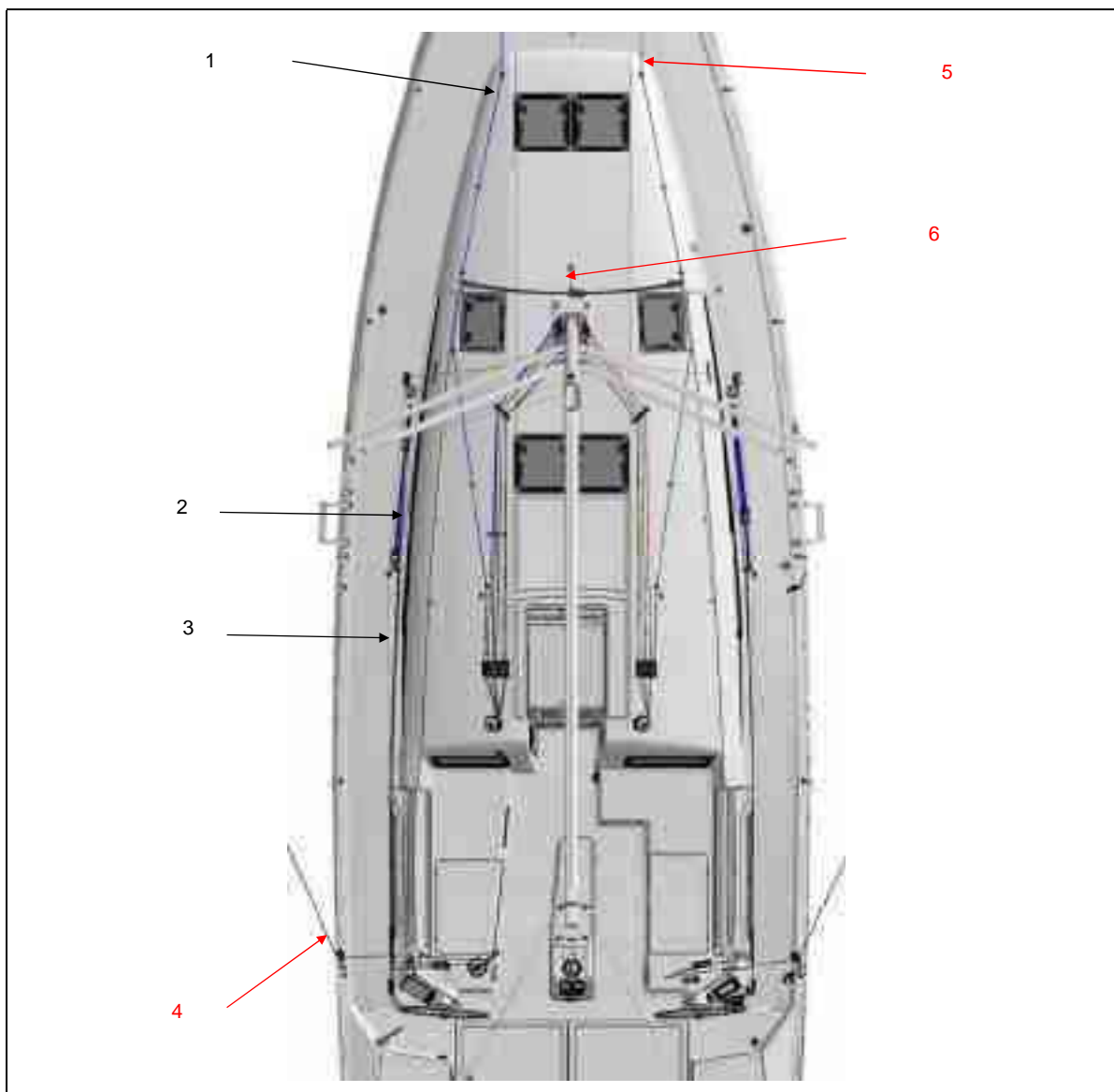

Reference	Designation
1	Genoa furler line
2	Genoa sheet
3	Mainsail sheet
4	Spinnaker sheet
5	Spinnaker tack
6	Self-tacking jib sheet

### System at mast foot (Port side)

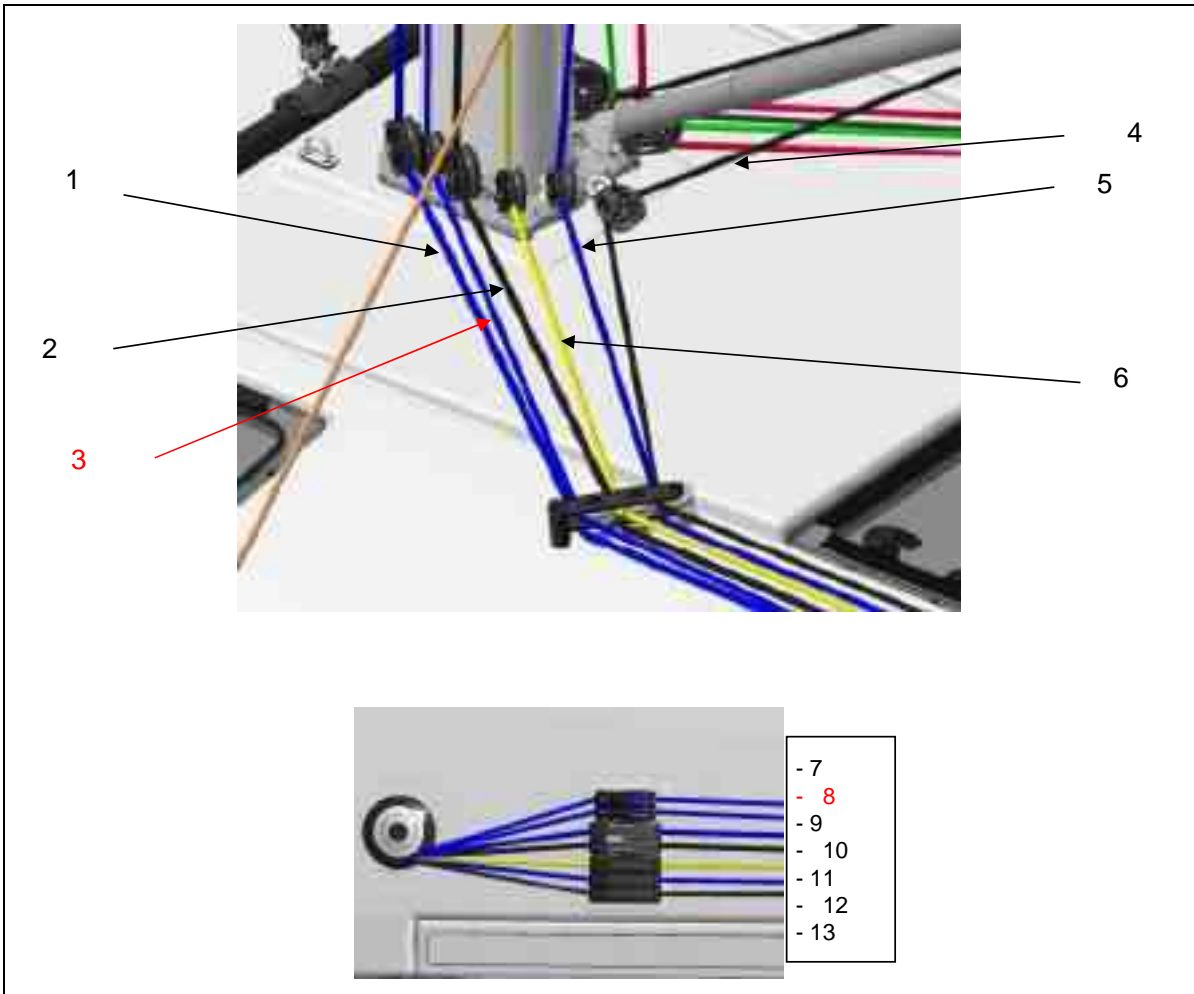

Reference	Designation
1	Genoa halyard
2	Main halyard
3	Self-tacking jib sheet
4	Kicking strap
5	Reef 3
6	Reef 1
7	Genoa furler line
8	Self-tacking jib sheet
9	Genoa halyard
10	Main halyard
11	Reef 3
12	Reef 1
13	Kicking strap

### System at mast foot (Starboard)

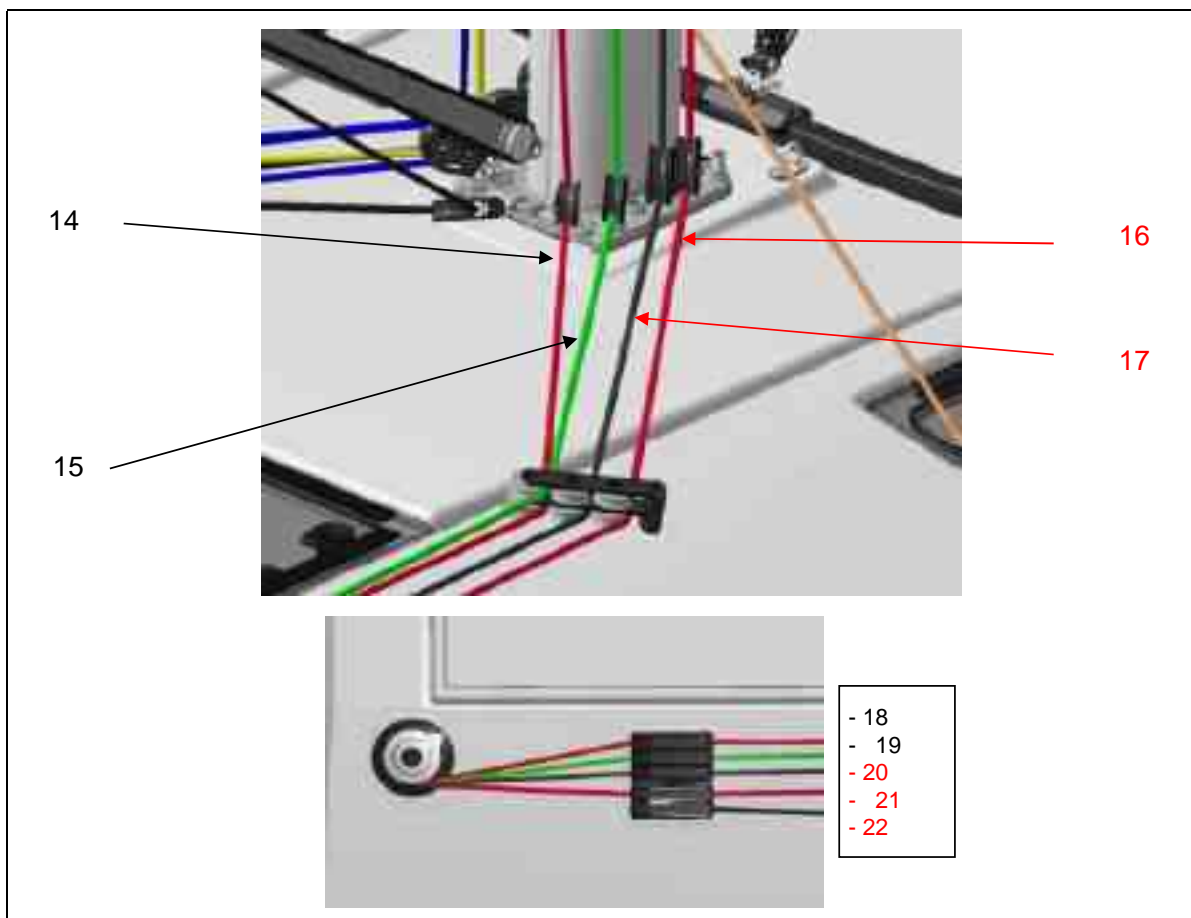

Reference	Designation
14	Mainsail foot
15	Reef 2
16	Spinnaker halyard
17	Fore stay sail halyard
18	Mainsail foot
19	Reef 2
20	Spinnaker lift / Fore stay sail halyard
21	Spinnaker halyard
22	Spinnaker tack

## 5.1.2 Roller furling mast

### System at mast foot (Port side)

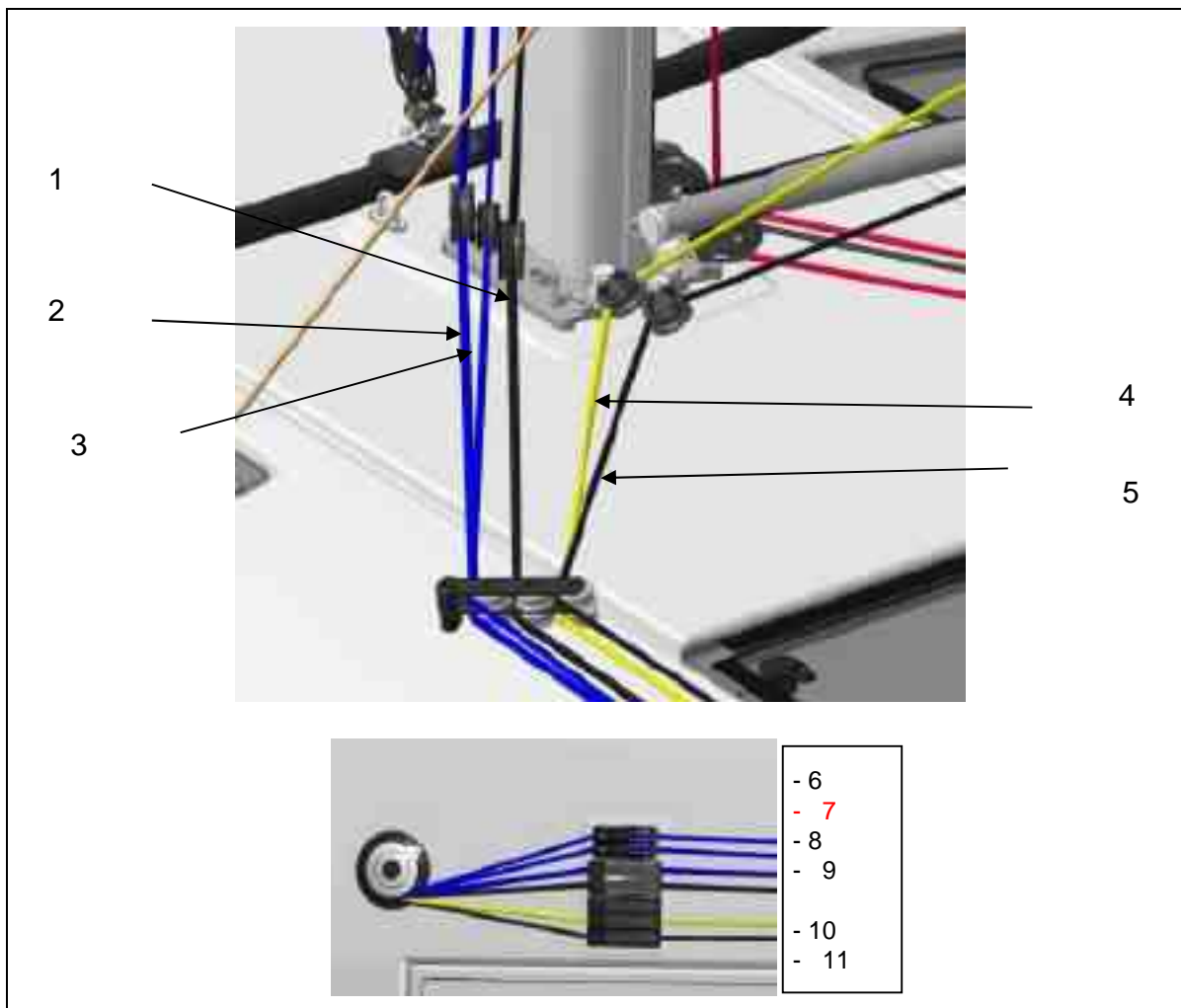

Reference	Designation
1	Main halyard
2	Genoa halyard
3	Self-tacking jib sheet
4	Mainsail safety block stopper
5	Kicking strap
6	Genoa furler line
7	Self-tacking jib sheet
8	Genoa halyard
9	Main halyard
10	Mainsail safety block stopper
11	Kicking strap

### System at mast foot (Starboard)

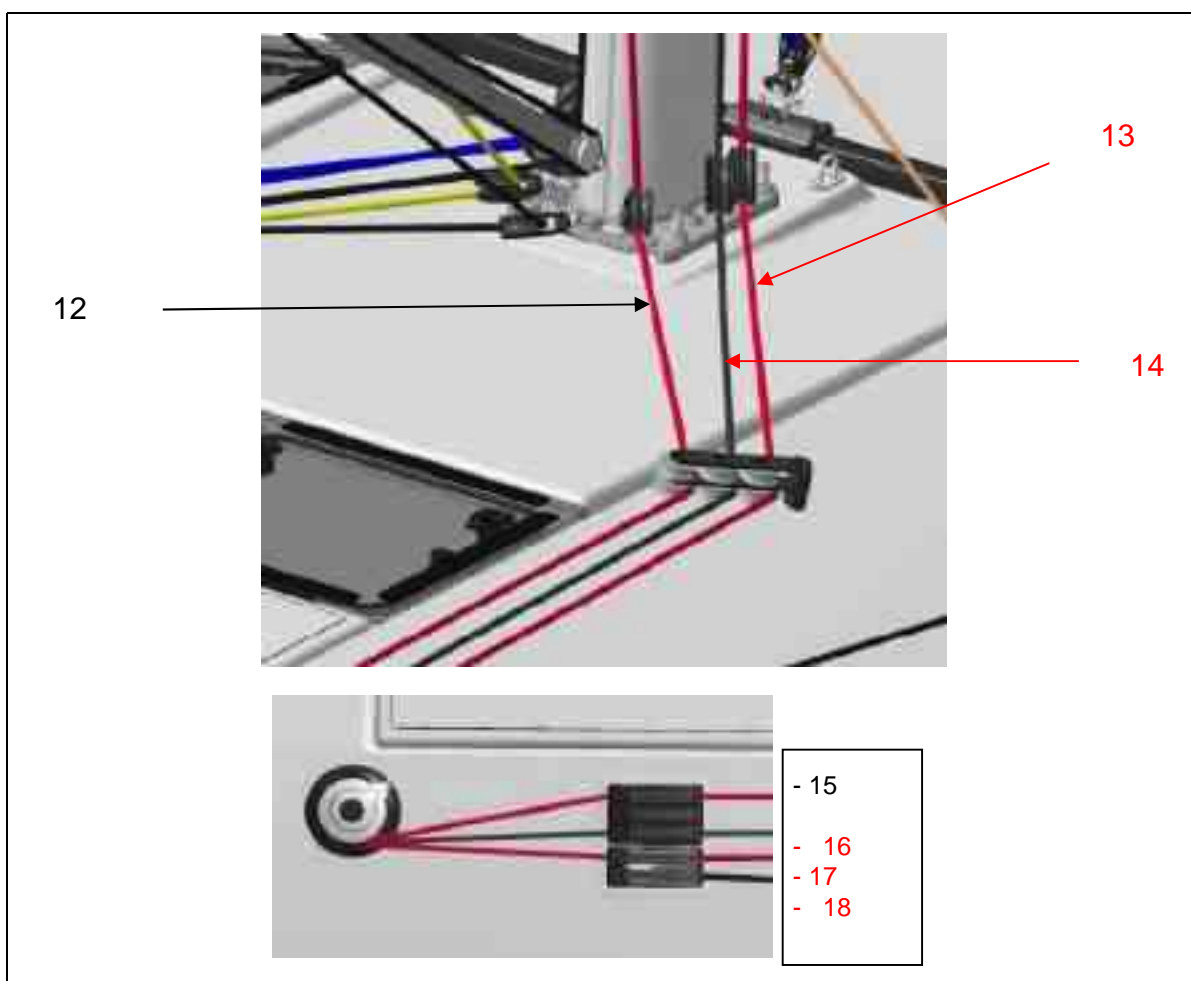

Reference	Designation
12	Mainsail foot
13	Spinnaker halyard
14	Fore stay sail halyard
15	Mainsail foot
16	Fore stay sail halyard
17	Spinnaker halyard
18	Spinnaker tack

## 5.2 STANDING RIGGING

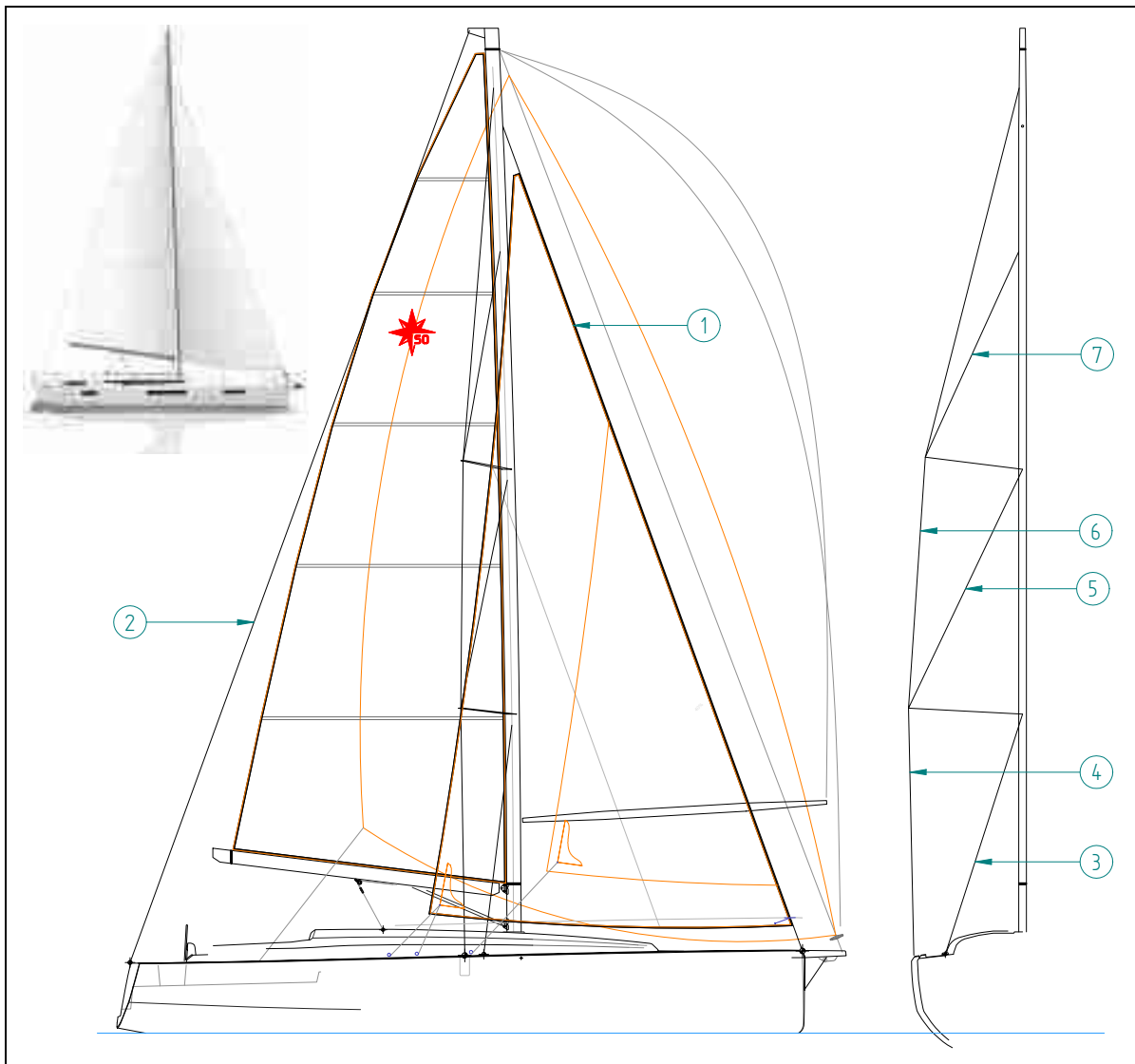

Reference	Designation
1	Forestay
2	Backstay
3	D1
4	V1
5	V2
6	V2D3
7	D3





Hydraulic backstay



- To hoist a crew member up to the top of the mast, make a bowline with the halyard directly on the bosun's chair ring (never use the halyard snap shackle or shackle).
- Never hoist a crew member when sailing in heavy weather.

### ADVICE-RECOMMENDATION

- The initial commissioning of your boat will require a lot of skill and care. The proper working of all your boat's equipment is the result of the quality of the commissioning operations.  
For this reason the stepping of the mast must be carried out under the responsibility of your dealer the first time the mast is stepped.
- Before each trip, carefully inspect the mast from top to bottom.
- Periodically check the rig tension and the tightness of the locknuts and bottle screw clevis pins.

### 5.3 RUNNING RIGGING

- Inspect the halyards for wear and condition.
- Regularly check the condition of the jam cleat jaws.
- Regularly clean the backstay blocks with fresh water.
- Avoid aggressive gybing in order to reduce premature wear on the sheets, attachment points and the gooseneck.
- If halyard tension (mainsail/genoa) is too great, this can lead to problems when hoisting/furling.



- When not sailing, slacken the genoa halyard and keep it away from the forestay (risk of halyard becoming furled around the forestay, which can lead to the stay breaking and dismasting of the boat).

**Table summarising running rigging**

Designation	Code	Supply	Quantity	Diameter (in mm)	Length (in m)	Colour	Accessories
<b>Jib</b>							
Jib halyard		Kit 187492	1	12	41	Navy Blue	
Jib halyard (Performance)	130108	Kit 126106	1	10	39	Mottled beige/Blue	Shackle Splice
Two-way switch (Performance)	126196		2	8	14	Grey/Blue	Splice
SHEET (Performance)		Kit 188560	2	12	16	Mottled blue/Beige	
SHEET (Self-tacking jib)	126109		1	10	34	Navy Blue	
<b>Asymmetrical spinnaker</b>							
Halyard	130505		1	10	43	Black Red blend	Snap shackle Splice
SHEET	132606	Kit 130190	2	12	24	Grey/Red	Snap shackle
Tack line	132609	Kit 130190	1	12	20	black/Red	Snap shackle Splice
<b>Code 0</b>							
Halyard	134931		1	10	61	Black Red blend	Shackle Splice



Table summarising running rigging

Designation	Code	Supply	Quantity	Diameter (in mm)	Length (in m)	Colour	Accessories
<b>Mainsail</b>							
Main halyard (Furler)		Kit 187492	1	12	43	black	Shackle
Main halyard (Performance)	130107	Kit 126106	1	10	41	Mottled beige / black	Splice Shackle
Furling line		Mast 187828	1	10	13,5	Yellow & White	
Uphaul		Kit 187492 126106	1	10	41	Grey	Shackle (1213)
SHEET (standard)		Kit 187491	1	10	36	Grey/black	
SHEET (Performance)		Kit 188560	1	10	36	Grey/black	
Bridle (SHEET)		Kit 187491 188560	2	10	1,08		Interior eye splice (1080mm & 70mm)
Foot tuning line (Furler)		Boom 187929	1	12	20	Black mottled / White	Splice
Foot tuning line (Classic)		Kit 188564	1	10	14	Black mottled / White	Shackle (1214)
Reef 1 (Automatic)		Kit 188564	1	10	26	Grey/ Yellow	
Reef 2 (Automatic)		Kit 188564	1	10	35	Grey/ Green	
Reef 3		Kit 188564	1	10	32	Grey/Blue	
Rigid kicker		Kit 187489	1	12	Starboard	black	

---

## 5.4 SAILS

### General points

- The working life of a sail mainly depends on its being regularly maintained.
- When sailing, trim the sails properly in accordance with the stresses in order to reduce the harmful strains on the fabric.
- Avoid wear and tear: Protect against chafing on gear with rough/sharp surfaces (spreaders, stanchions, etc).
- Keep a sailmaker's kit and explanatory booklet onboard to carry out emergency repairs whilst waiting for a professional sail-maker.
- Rinse the sails in fresh water regularly and dry them quickly to avoid mildew. Avoid drying the sails on the mast in the wind: Flogging wears the seams and risks tearing the sails on the rigging.
- UV rays severely attack sails: If sails remain rigged, even for 24 hours, cover them with a sailcover or protective fabric.
- The genoa can be fitted with an anti-UV strip: Make sure that the furling direction on the furling drum is correct (the UV strip must appear on the outside).
- Never use force if the sail sticks when furling or unfurling. If this happens, check that a halyard is not rolled around the forestay.

### Sail storage/folding

- Remove the sails if your boat is not to be used for a long time.
- Avoid storing a wet sail to prevent the appearance of mould and mildew.
- Flake the sail parallel to the foot, then roll it up to the bag dimensions.



- Beyond 20 knots, you are advised to stow the lazy-bag.

### **ADVICE-RECOMMENDATION**

When the sailing season is over and, if possible, before winter, take the suit of sails to a professional for an overhaul and effective repairs.



## 5.5 SETTING THE SAILS

### Mainsail

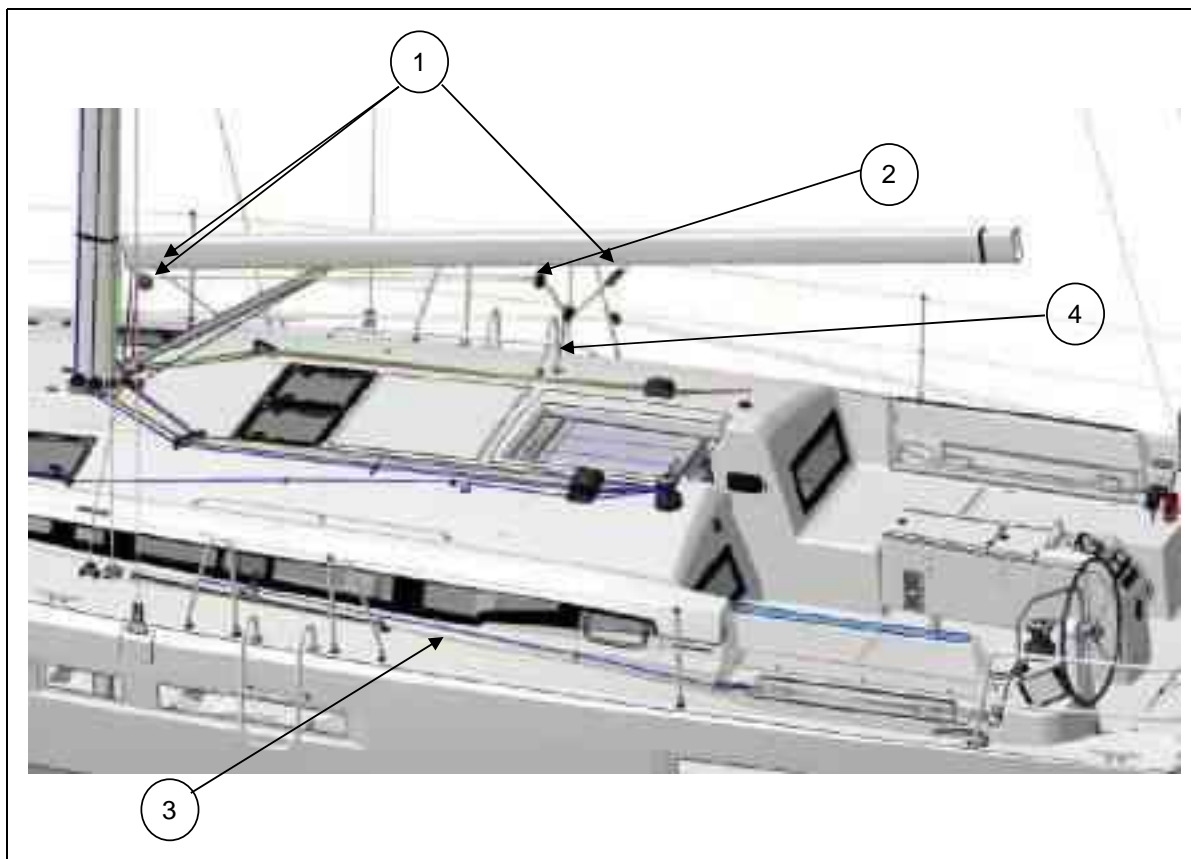

Reference	Designation	Quantity
1	Single pulley	7
2	Double blocks	2
3	Mainsail sheet	1
4	Pig tail	2

## Genoa

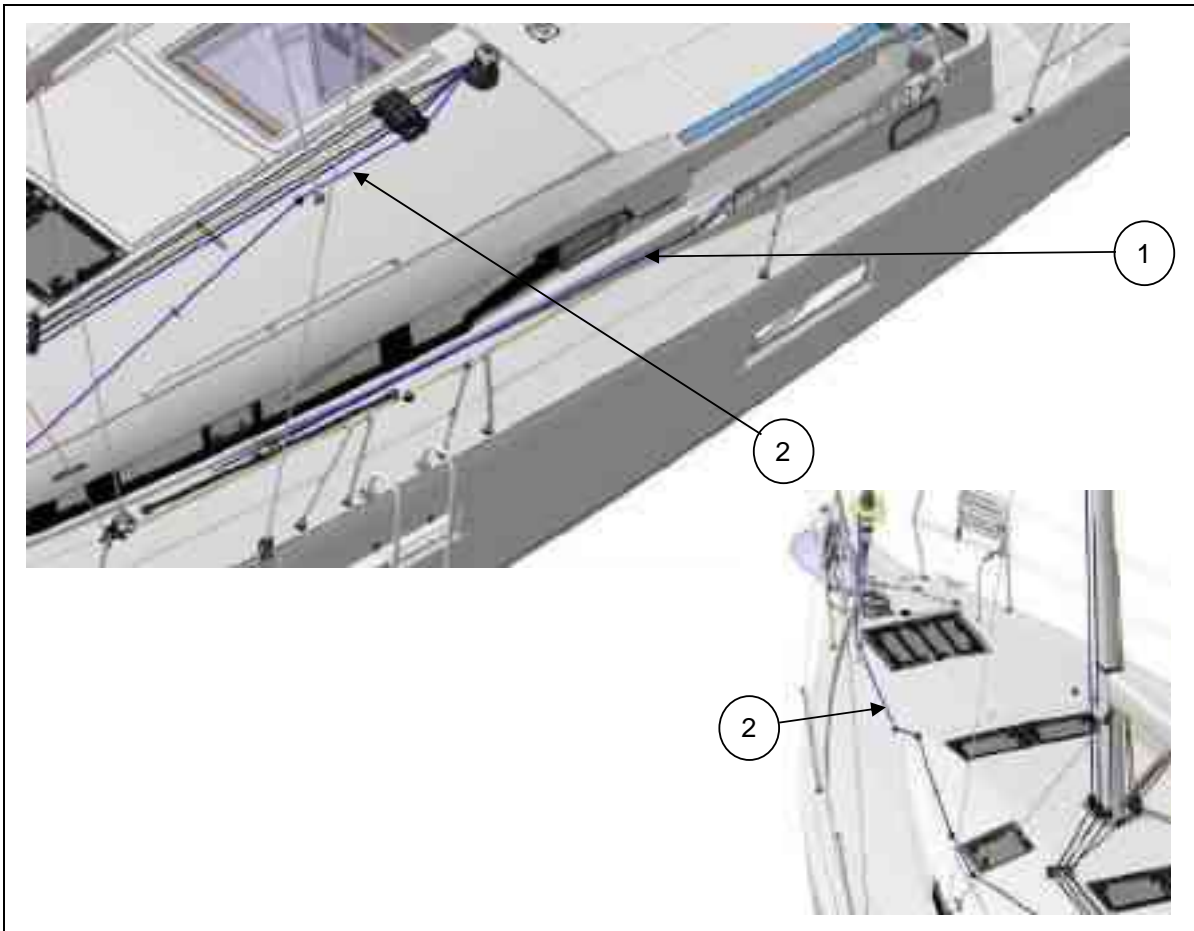

Reference	Designation	Quantity
1	Genoa sheet	2
2	Genoa furler line	1

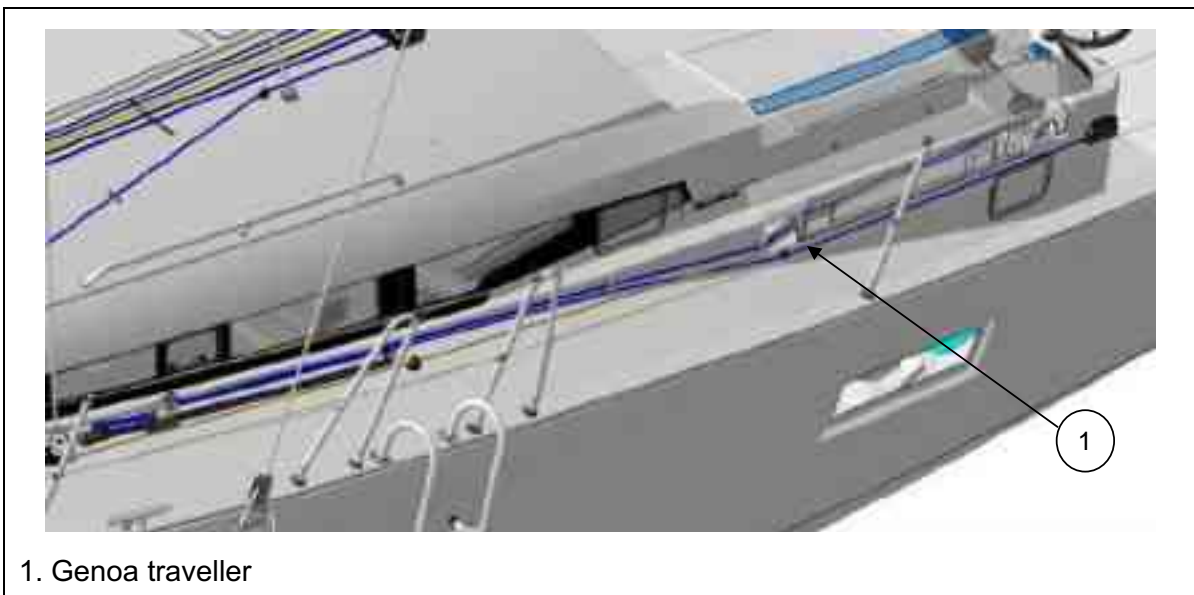



## Self-tacking jib / Staysail

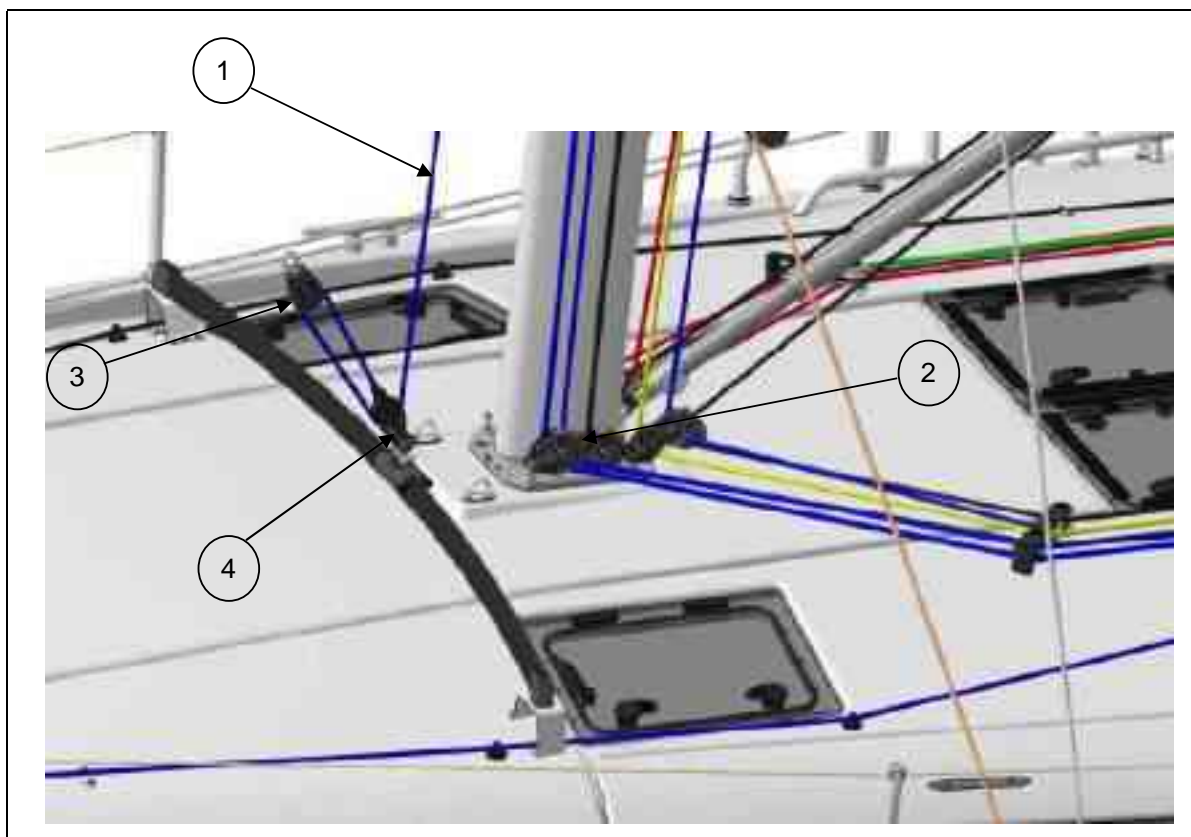

Reference	Designation
1	Staysail sheet
2	Pulley with screed
3	Swivel single pulley
4	Pulley

Code 0

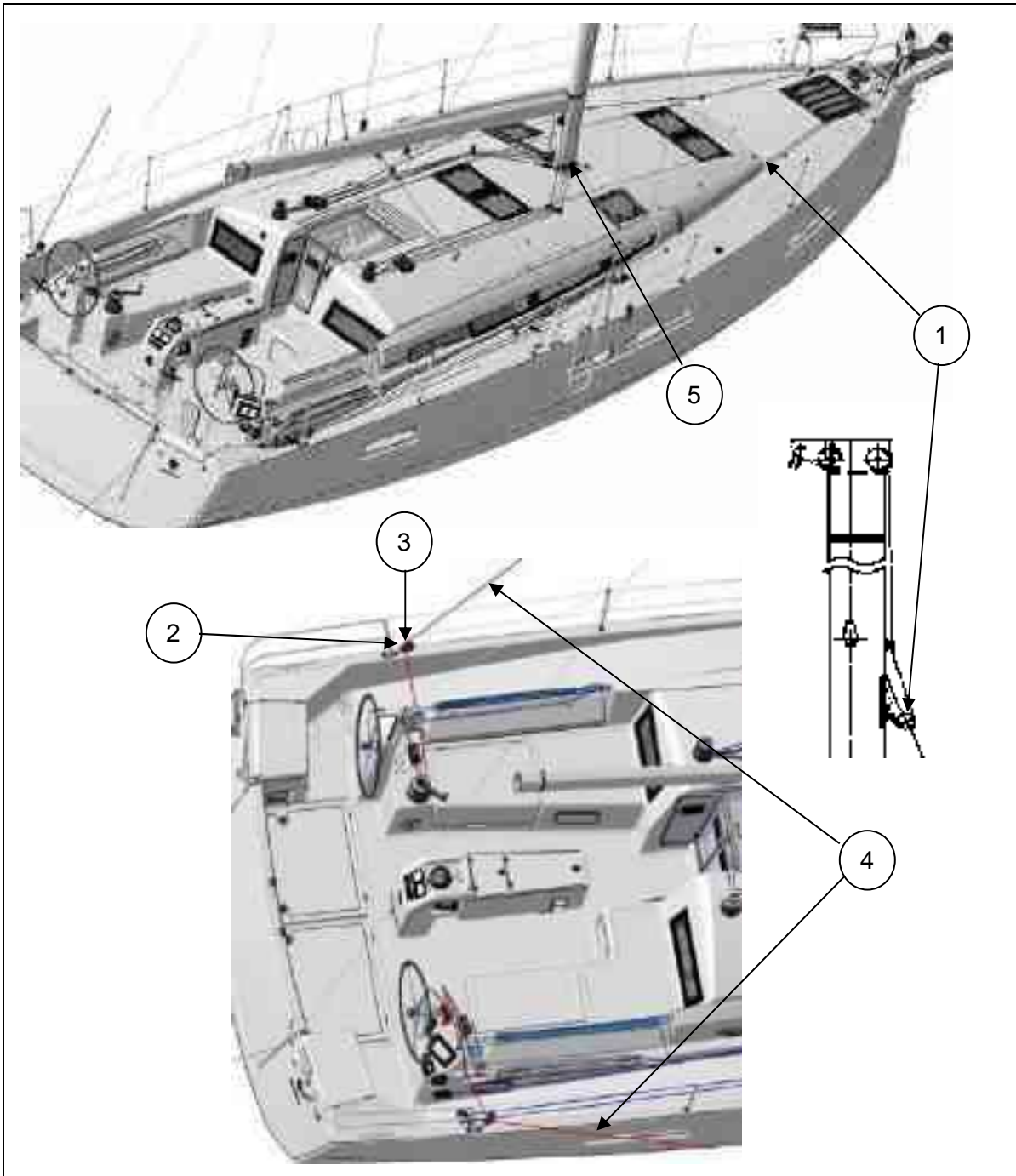

Reference	Designation	Quantity
1	Block rigging - Halyard	1
2	Pig tail	2
3	Swivel single pulley	2
4	Spinnaker sheet	2
5	Pulley with screed	1



### Asymmetrical spinnaker

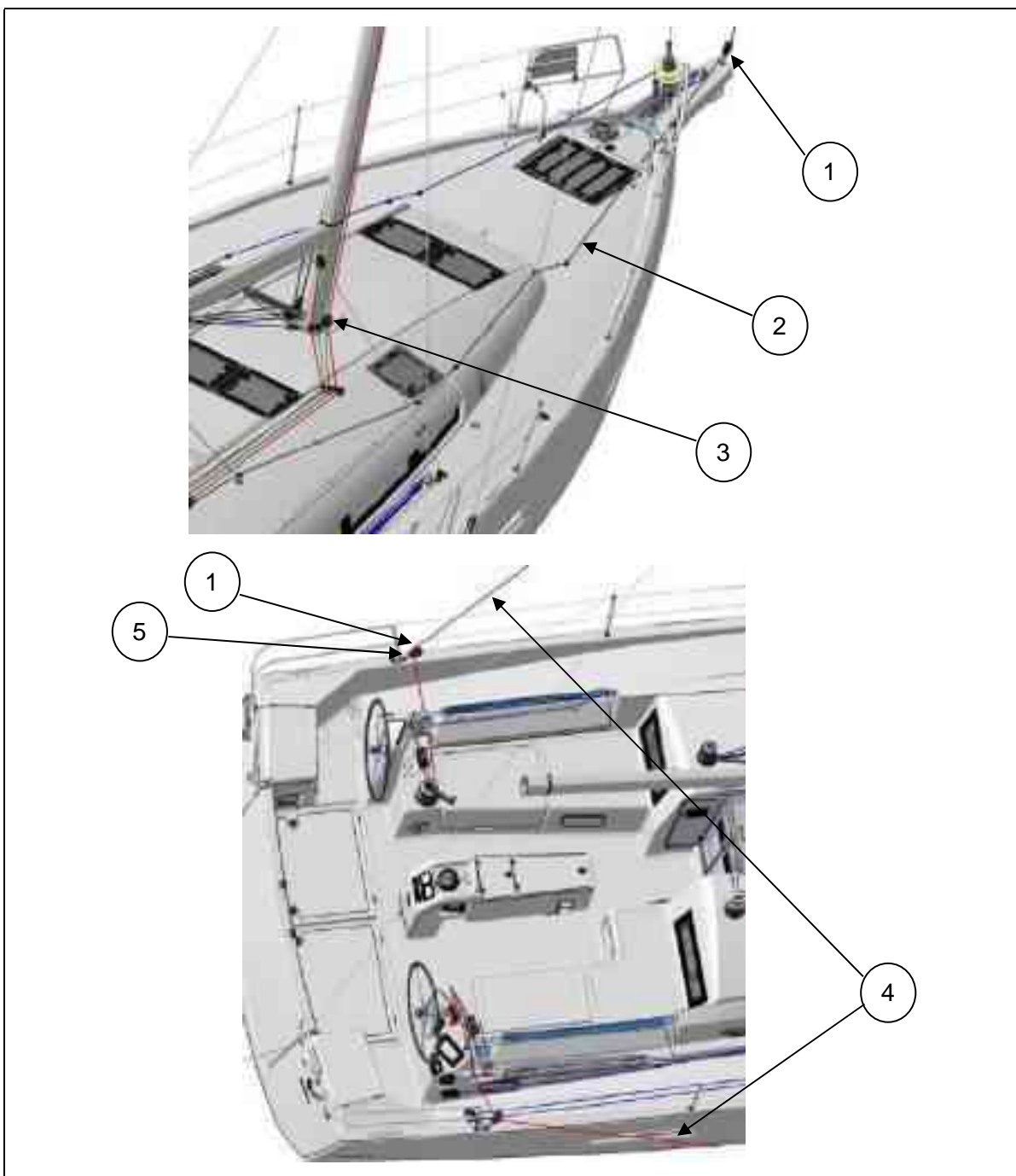

Reference	Designation	Quantity
1	Swivel single pulley	3
2	Spinnaker tack	1
3	Pulley with screed	1
4	Spinnaker sheet	2
5	Pig tail	2

---

## 5.6 DECK FITTING

### General points

- Inspect each piece of deck gear regularly (blocks, shackles, swivels, jam cleats, etc): Check that there are no cracks, corrosion or deformation.
- When replacing a piece of deck gear, make sure that you use a type with the same strength specifications.
- If careful, regular inspections are not carried out and damaged parts and/or worn ropes are not replaced, a block or tackle may suddenly break and cause an accident or serious injury and damage the boat.

### Maintenance

- On return from sailing always rinse deck gear with fresh water.
- Wash deck gear regularly with non-abrasive soap by making the block sheaves turn. Rinse afterwards with fresh water.
- Never use grease on deck gear parts (apart from the winches).
- Never use caustic-based cleaning materials on deck gear parts (such as some teak cleaners).

## 5.7 WINCHES

### Manual winches

- Do not leave loose ropes on the winches but make them fast on cleats.

### Electric winches

- The electric winches are supplied by direct current.
- A breaker protects the electrical circuit.
- An operation relay is fitted to the electrical circuit.
- A load controller is fitted to the electrical circuit: This system protects the winches against overload by temporarily interrupting the electrical supply. The load controller is programmed in the factory.
- Inserting a winch handle into an unloaded winch automatically disconnects the motor transmission and allows it to be used manually.



**NOTE: Heavy use is made of the batteries when operating the electrical winches: Make sure the battery bank is systematically recharged after a day's sailing.**

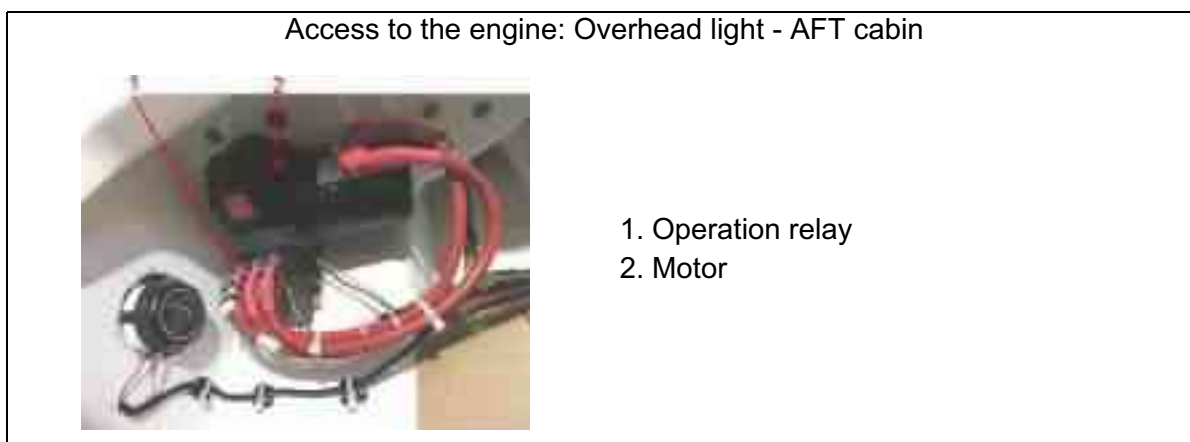

---

## Operation

- Remote control by 2 buttons, the winch REWIND is used to sheet in or ease the sails under heavy load without having to remove the self-tailing mechanism ropes.
- Simply pressing the red button at the base of the winch is enough to activate the function REWIND:
  - turned to the left, the winch allows the function REWIND (sheeting in or easing off the sail);
  - turned to the right, the winch is used like a traditional electric winch with the possibility of sheeting in at slow or fast speed.



## Rinse winches regularly with fresh water

- Rinse winches regularly with fresh water.
- Dismantle, clean and lubricate each winch annually. Parts that have been damaged or worn may need replacing.



The use of an electric winch for furling/unfurling the genoa or any other foreward sail is strictly forbidden (risk of the forestay breaking which may lead to demasting).



- Refer to the manufacturer's instructions for use and maintenance.
- Avoid bulky clothing, long hair and jewellery that might become caught in the winch when it is moving. Avoid riding turns when using the winches.

### Layout diagram - Electric winch

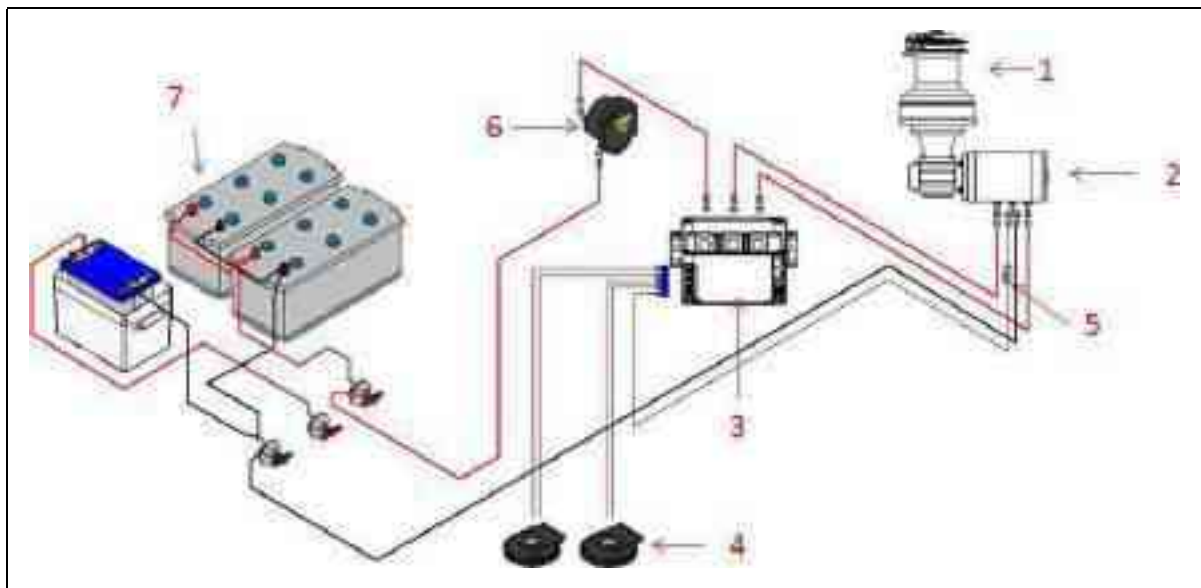

Reference	Designation
1	Winch
2	Motor
3	Operation relay
4	Waterproof switches
5	Fuse
6	Breaker
7	Service battery

---

## 5.8 GENOA FURLER

### Operation

- Leave several turns of the furling line around the drum.
- Furl/unfurl the genoa slowly so that the furling line is always under light tension thus avoiding any riding turns in the drum.
- Never slacken the genoa halyard when furling/unfurling the sail.
- When furling in light winds, it is recommended to keep the sheet under slight tension so that the genoa furls correctly.

### Maintenance

- Rinse the furling drum regularly.
- It is recommended to rinse mechanical parts at least once a year in fresh water.



Refer to the manufacturer's instructions for use and maintenance.



## 5.9 SINGLE LINE FURLER

The jib furler differs from roller reefing gear by its use: The foresail is either completely furled or fully out. It is not possible to sail by reducing the sail plan as can be done with roller reefing gear.

### Maintenance

- Rinse the drum regularly.
- It is recommended to rinse mechanical parts at least once a year in fresh water.







## 6 SAFETY

### 6.1 PREVENTING MAN OVERBOARD SITUATIONS AND THE MEANS OF GETTING SOMEONE BACK ONBOARD

#### 6.1.1 Prevention of man overboard

- The off-limits areas of the working deck when the boat is under way are cross-hatched below:



- The "working deck" means those areas outside where people stand or walk during normal use of the boat.



***NOTE: Standing on the sunbed is prohibited.***



Ref 1 & 1': Fitting a means of climbing back onboard.

Ref 2: Mooring cleats (which correspond to the anchor points for the lifelines).



- Use the seats provided.

Regularly check the guard-rails:

- With metal guard-rails, watch for corrosion particularly at connecting points.
- With synthetic guard-rails, change them as soon as they show signs of wear due to chafing or UV.



### 6.1.2 Getting back onboard

The means for getting back onboard must be able to be deployed by one person alone in the water, with no other help.

Installation of means to get back on board in the event of an accidental fall:  
(Ref 1):



**SAFETY**

#### Description of the installation stages::

Assembling the ladder:

- Take the ladder out of its case and fit the ladder by tying a lark's head type knot. The knot must face outside.
- Place the flap of the case between the loop of the ladder and the first step.
- Screw on the flap with the two bolts and nuts on the back. The nuts should be on the back of the case to ensure they do not prevent the ladder from being taken out for use.
- Adjust the length of the cord to reach the water level and check that the ladder is properly released. It is important to ensure that the ladder extends smoothly into the water. Attach the end of the cord to the swivel plate provided for this purpose. Finally stow away the ladder and close the internal flap with press studs.



Installation of means to get back on board when swimming:  
Swimming ladder (Ref 1'):



- Some types of equipment for getting back onboard have a locking device when folded up: It is important to keep the means for getting back onboard deployed and ready to use once the boat is in use (at anchor, moored or at sea).
- Make sure that the means for getting back onboard are readily accessible and easy to use by someone alone in the water.
- Before using your boat, make sure the safety ladder is in its place.



- Make sure your safety ladder is installed in accordance with the installation diagram.
- Make sure the triggering line is installed in accordance with the installation diagram.

**AVERTISSEMENT**

Veillez à ce que l'échelle souple soit installée conformément aux instructions du Manuel Propriétaire. Veillez également à ce que le bout déclencheur soit mis à poste conformément aux instructions.

**WARNING**

Make sure that the flexible ladder is installed as specified in the Owner's Manual. Also make sure that the rope trigger is installed in accordance with the instructions.

## 6.2 STORING THE LIFE-RAFT



SAFETY

The life-raft(not supplied) must be stored in the space provided for it (Ref 1). A pictogram helps to locate it easily.



Before putting to sea, carefully read the launching instructions shown on the liferaft.

It is the responsibility of the skipper to ensure regularly that the bib is properly secured in place.

---

### 6.3 SECURING MOVEABLE ITEMS

The technical areas are identified in the boat by the pictogram below:



The electrical technical areas are identified in the boat by the pictogram below:



Technical areas may not be used as storage compartments.



- Ensure that movable items are firmly secured when the boat is under way.
- Don't store anything below the floorboards.



## 6.4 DECK LAYOUT

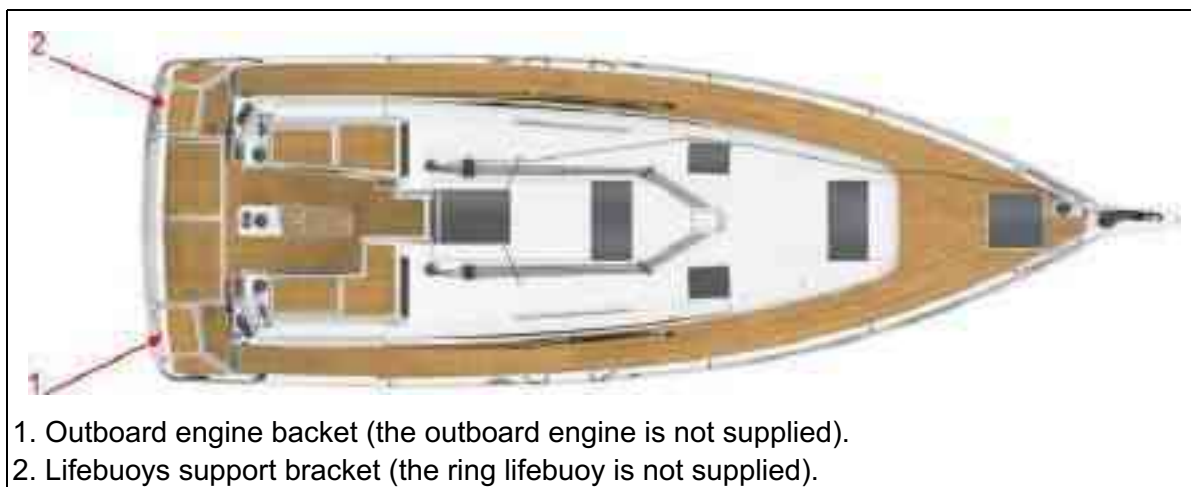

**SAFETY**



The maximum weight of the outboard engine on the pushpits must not exceed 20 kg.

## 6.5 INFORMATION ABOUT THE RISKS OF FLOODING AND ABOUT THE BOAT'S STABILITY

### 6.5.1 Openings in hull

- Valves, through-hull inlets and other accessories in brass or bronze have a life of about 5 years. It is necessary to have a professional check on all valves, through-hull inlets and other accessories in brass or bronze edge every 5 years and replace them as necessary.

**View of hull, starboard side**

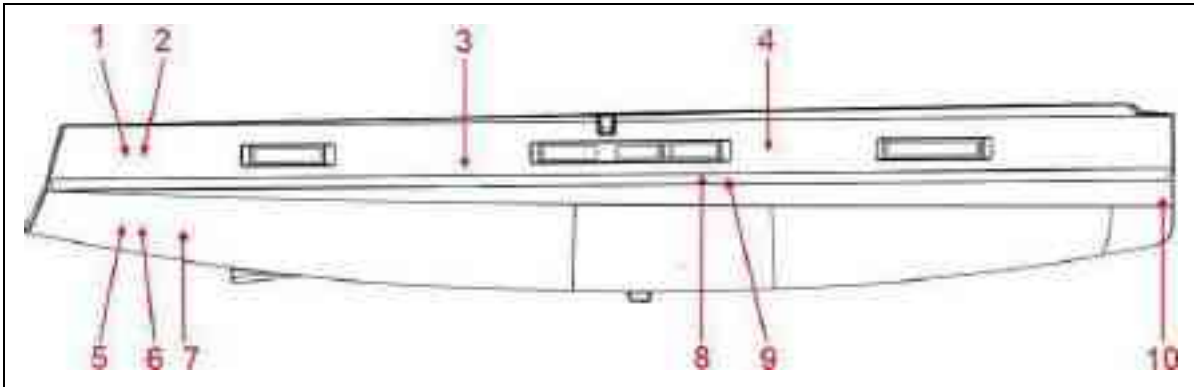

Reference	Designation	Valve
1	Electric bilge pump draining	Not
2	Vent hole - Water	Not
3	Black water tank (WC)	Not
4	Water tank vent	Not
5	Cockpit draining	Not
6	Drainage - Cockpit locker	Not
7	Seawater discharge - Air conditioning	Yes
8	Seawater discharge - Air conditioning (x2)	Yes
9	Air conditioning drainage (Condensation water)	Yes
10	Chain locker scupper	Not





View of hull, port side

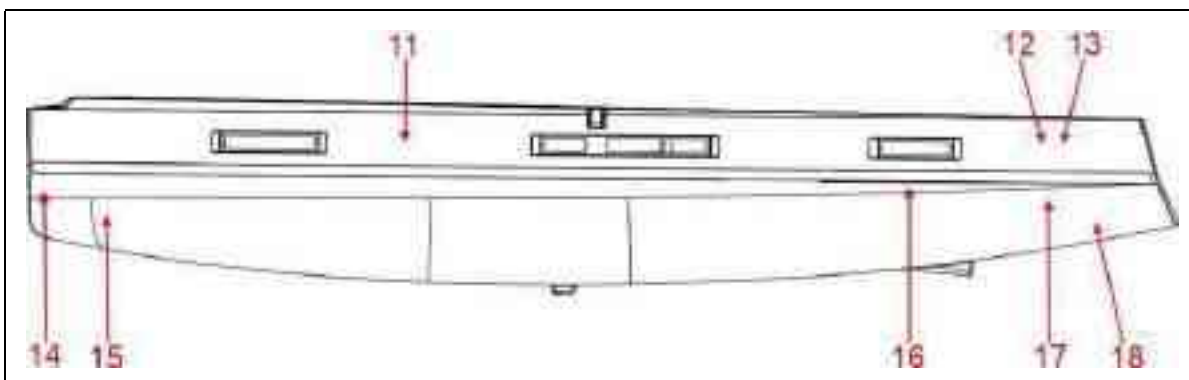

SAFETY

Reference	Designation	Valve
11	Black water tank (WC)	Not
12	Fuel tank vent	Not
13	Draining of manual bilge pump	Yes
14	Chain locker scupper	Not
15	Sea water intake - Deck wash pump	Yes
16	Seawater discharge - Water maker	Yes
17	Cockpit draining	Not
18	Engine exhaust	Not

Top view

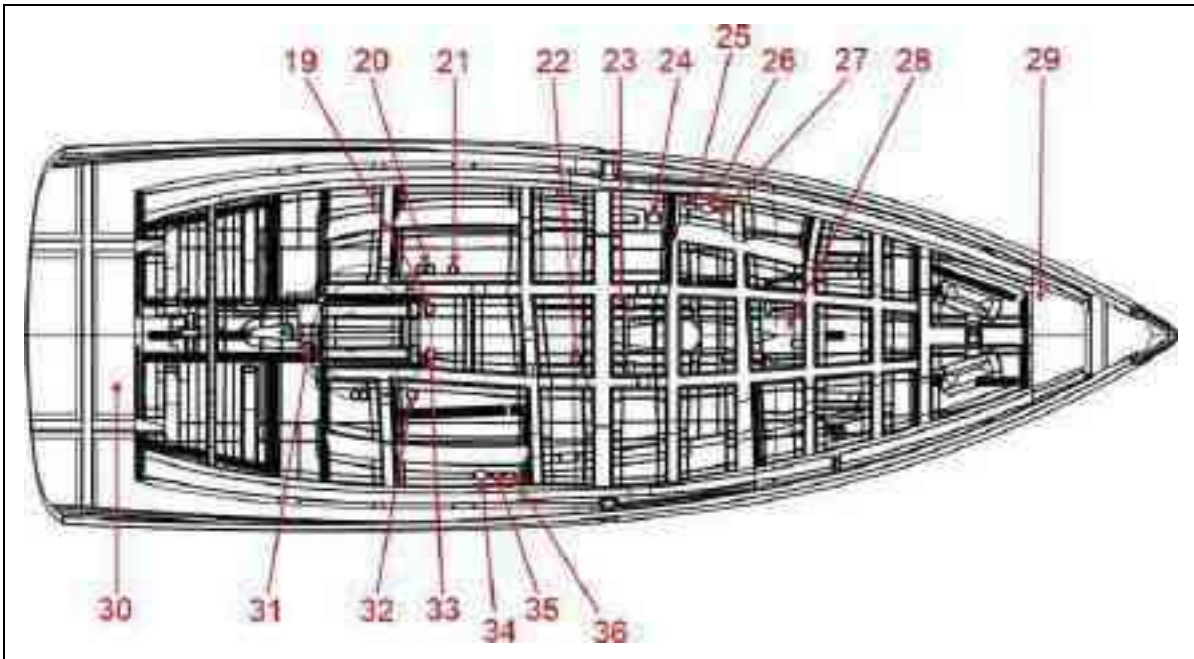

Reference	Designation	Valve
19	Sea water intake - Motor	Yes
20	Earthing plate - DC/AC converter & Generator	Not
21	Sea water intake - Water maker	Yes
22	Sea water intake - WC	Yes
23	Sea water intake - Foot pump	Yes
24	Galley sink drain	Yes
25	Head washbasin evacuation	Yes
26	Black water drainage tank (WC)	Yes
27	Sea water intake - WC	Yes
28	Sensor	Not
29	Sea water intake - Deck wash pump	Yes
30	Seawater discharge - Generator	Yes
31	Sea water intake - Sternpost	Yes
32	Sea water intake - Generator	Yes
33	Sea water intake - Air conditioning	Yes
34	Black water drainage tank (WC)	Yes
35	Head washbasin evacuation	Yes
36	Sea water intake - WC	Yes



## 6.5.2 Drainage system

### General points

- The inner moulding of the hull has channelling: the drainage channels. The drainage channels allow the water to drain down to the lowest point in the boat, where it can be discharged. So it is important to allow the water to flow freely down to this lowest point of the boat, which includes.
- Regularly cleaning the lowest point of the boat and the drainage channels.

**SAFETY**

### **Diagram of the layout - Drainage channels**

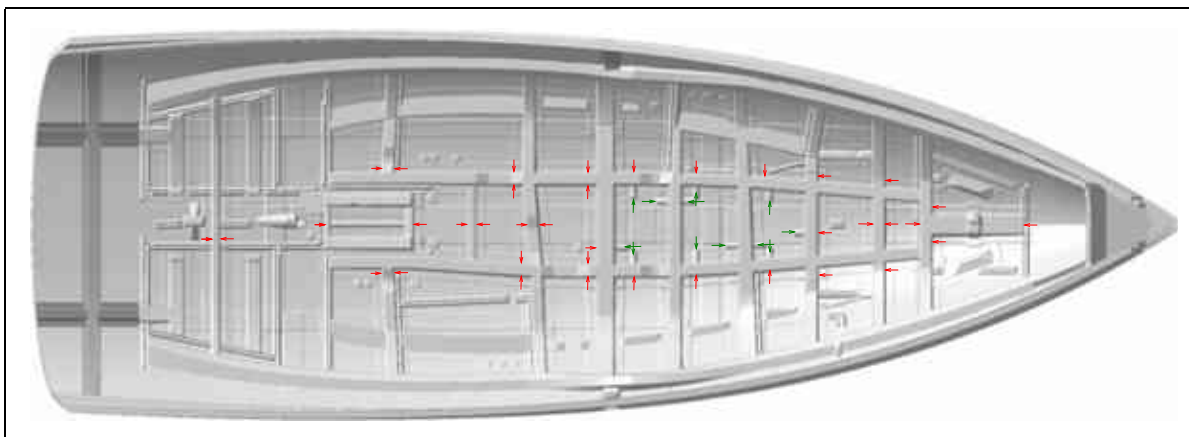

### Diagram of the layout - Bilge pumps



Reference	Designation	Rate
1	Manual bilge pump	32 L/minute (*)
2	Manual bilge pump lever	
3	Electric bilge pump	129 L/minute
4	Electric bilge pump switch	

(\*) 45 strokes/minute

## **Secondary drainage system**

### **Manual bilge pump**

The manual bilge pump is in the cockpit (Ref 1).

The bilge pump lever is located close to it (Ref 2).



**SAFETY**

### **Operation:**

I- Put the lever on the manual bilge pump.

II- Repeatedly work the lever up and down to its fullest extent.

The manual bilge pump lever must remain accessible at all times.



---

## **Main drainage system**

### **Electric bilge pumps**

- The bilge pumps are powered by DC.



- The switch for the electric bilge pump is located on the switch panel (Ref 4).

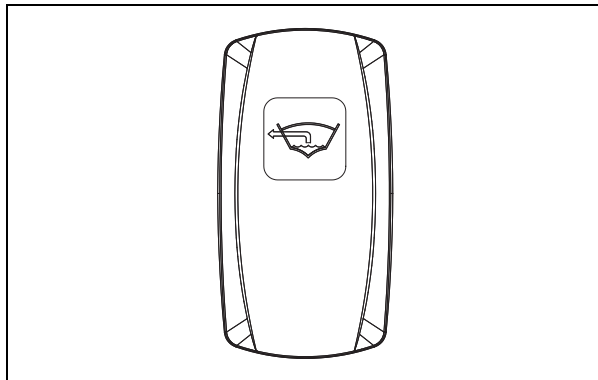

- The electric bilge pump must only be used to discharge stagnant water at the bottom of the bilge. It must not be used to pump out any oil-based products (petrol, oil) or inflammable liquids.

#### **Operation:**

I- Turn on the battery switches.

II- Switch on the bilge pump (Ref 4).

If the boat is equipped with an automatic bilge pump, the switch has an always-on position.



### Bilge pump maintenance

Please refer to the manufacturer's notes on the instructions for checking and maintaining the bilge pumps.



- The drainage system is not designed to control water coming from breaches in the hull.
- Keep the water level in the bilges to the minimum.
- Never store anything right at the bottom of the boat: Allow bilge water to flow freely down to the lowest point of the boat.

**SAFETY**

### **SAFETY PRECAUTIONS**

- Check that each bilge pump is working at regular intervals.
- Clear the bilge pump points or strainers of any debris that could clog them.
- If the watertight partitions which seal off the fore and aft points are fitted with valves they must be closed at all times and only opened to drain water into the main bilge.

## Diagram of the layout - Drying out the bilge

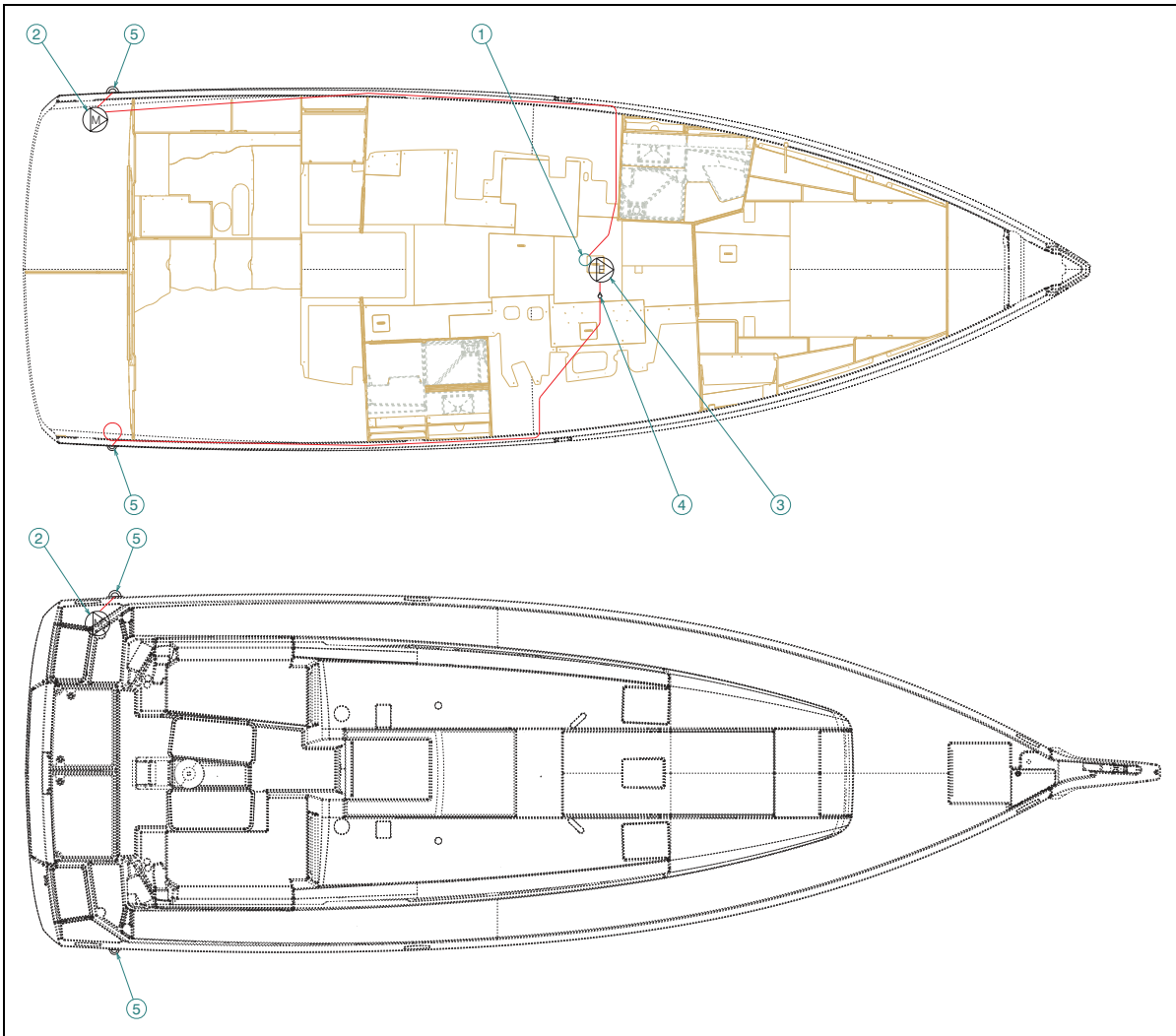

Reference	Designation
1	Intake strainer
2	Manual bilge pump
3	Electric bilge pump
4	Non-return valve
5	Kitchen sink evacuation through-hull





## 6.6 EMERGENCY SYSTEMS IN CASE OF STEERING GEAR FAILURE

### Emergency tiller

The emergency tiller is designed only to be able to continue underway at a reduced speed in case of steering gear failure.

### location of components



Reference	Designation
1	Port emergency tiller access point
2	Starboard emergency tiller access point
3	Emergency tiller

SAFETY

---

## **Instructions in the event of steering gear failure**

- I. Unscrew the securing fitting using a winch handle (Ref. 1 or 2).
- II. Fit the emergency tiller (Ref 3) in the square on the rudder post.

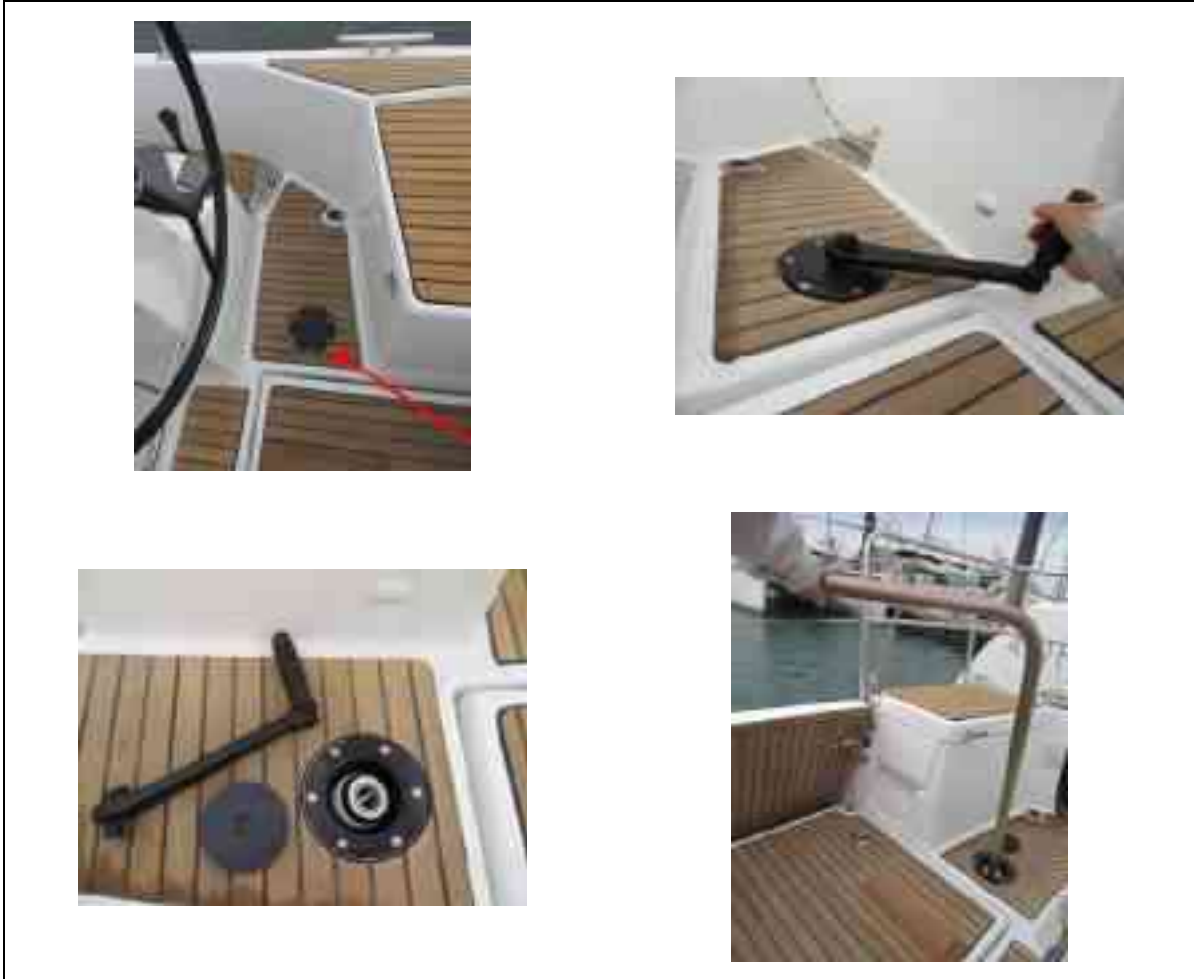

Emergency tiller storage:  
Cockpit locker





## 6.7 INFORMATION RELATED TO THE RISKS DUE TO LIGHTNING

- The skipper must check the weather conditions before deciding to put to sea. If there is a risk of thunderstorms, the skipper must avoid putting to sea.
- A device against lightning is installed on the boat.
- An earth braid connects the mast foot to the keel.

### Precautions to be taken by the occupants of the boat during a storm

- Boat occupant safety assurance is the basic goal of lightning protection.
- Shut off the engine, turn off the battery switches, disconnect all electronic and electrical equipment, including those mounted on the mast.
- Occupants should stay as much as possible inside the closed vessel.
- Occupants should not be in the water or let their arms or legs hang in the water.
- Occupants should avoid touching any part connected to a lightning protection device, especially in order to connect these parts.
- Occupants must avoid contact with the metal parts of the rigging, spars, deck fittings and boat wiring. Even inside the boat, occupants should stay as far as possible away from the mast.

### Maintenance

- Flexible radio antennas should not be tied down during a thunderstorm.
- If the boat has been struck by lightning, compass and electronic and electrical equipment must be examined to determine whether any damage or calibration change has occurred.
- If the vessel has been struck by lightning, the lightning protection device must be inspected for damage and to verify the integrity of the device and the continuity of the earthing.





## 7 INFORMATION RELATING TO FIRE RISKS AND RISKS OF EXPLOSION

### 7.1 PROPULSION ENGINES AND OTHER FUEL-BURNING EQUIPMENT



The risks associated with motorisation are described in the **ENGINE** chapter.

#### Note concerning the boat's tender:

- If the tender is fitted with a more powerful outboard motor than 25 Kw, it must have on board a portable extinguisher with a rating equal to or greater than 8A / 68B.
- Place for storing the petrol tank of the tender: on deck.



The risks associated with other fuel-burning equipment are described in the **EQUIPMENT OTHER THAN FOR PROPULSION, WHITH BURNS FUEL** chapter.

### 7.2 ELECTRICAL SYSTEM



The risks associated with the electrical systems are described in the **ELECTRICITY** chapter.

### 7.3 GAS SYSTEM



The risks associated with the gas system are described in the **GAS** chapter.

---

## 7.4 FIRE-PREVENTION AND FIRE-FIGHTING EQUIPMENT

### 7.4.1 Fire-fighting equipment

#### **Portable fire-extinguishers and fire blanket (not supplied)**

- When in use, this boat must be equipped with portable fire extinguishers of the following extinguishing capacity and located in the following places:



Location	Minimum extinguishing capacity
Chart table seating	5A / 34B
Aft cabin closet	5A / 34B

- The location of the portable fire extinguishers is shown by the pictogram below:



- When in use, this boat must be equipped with a fire blanket to protect the cooking equipment and/or the galley, installed in the following place: near the cooking equipment.



## **Maintenance of the fire-fighting equipment**

The owner/person operating the boat must:

- Get the fire-fighting equipment checked at the frequency shown on the equipment;
- Replace portable fire extinguishers, if outdated or discharged, by extinguishing apparatus of equal capacity;
- Provide at least one fire bucket with a lanyard, in a readily accessible place, for protection on deck;
- Get the fixed fire extinguishing systems filled or replaced if they are discharged or have expired.

## **Responsibility of the owner/boat operator**

It is the responsibility of the owner/boat operator to:

- Ensure that the fire-fighting equipment (portable extinguishers, bucket and fire blanket) is readily accessible when there are people onboard;
- Ensure that the engine compartment fire extinguisher discharge port is readily accessible;
- Show the members of the crew:
  - The location and use of the fire-fighting equipment;
  - Location of discharge ports in engine compartment;
  - The location of evacuation routes and fire exits.
- Equip the vessel with one or more portable extinguishers whose heads are compatible with the diameter of the discharge orifice in vertical use.
- Unlock all deck hatches and fire escape openings when the vessel is occupied.

## **Notes for the attention of the boat user**

### **General points**

- Check that the bilges are clean and frequently check that there are no fuel/gas vapours or fuel leaks.
- In the case of replacement of components of the fire-fighting equipment, use only the appropriate components of the same code designation or having the equivalent technical capacity and fire resistance.
- Do not install free-hanging curtains or other fabrics near or above the cooking appliances or other equipment with a naked flame.
- Do not store combustible materials in the engine compartment. If non-combustible materials are stored in the engine compartment they must be secured so there is no danger of them falling on machinery and they do not obstruct access to and from the compartment.
- The fire exits other than the door or main companionway are identified by the following symbol:



---

### 7.4.2 Extinguisher access hole (Engine compartment)

The engine compartment has a port that makes it possible to inject the extinguishing product inside without opening the usual access hatches.

Location of the fire extinguisher port



A pictogram helps to locate it easily

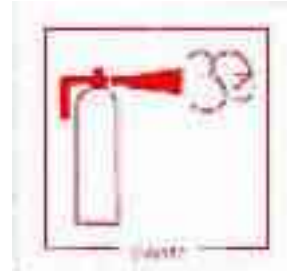



## 7.5 EMERGENCY EXITS IN CASE OF FIRE

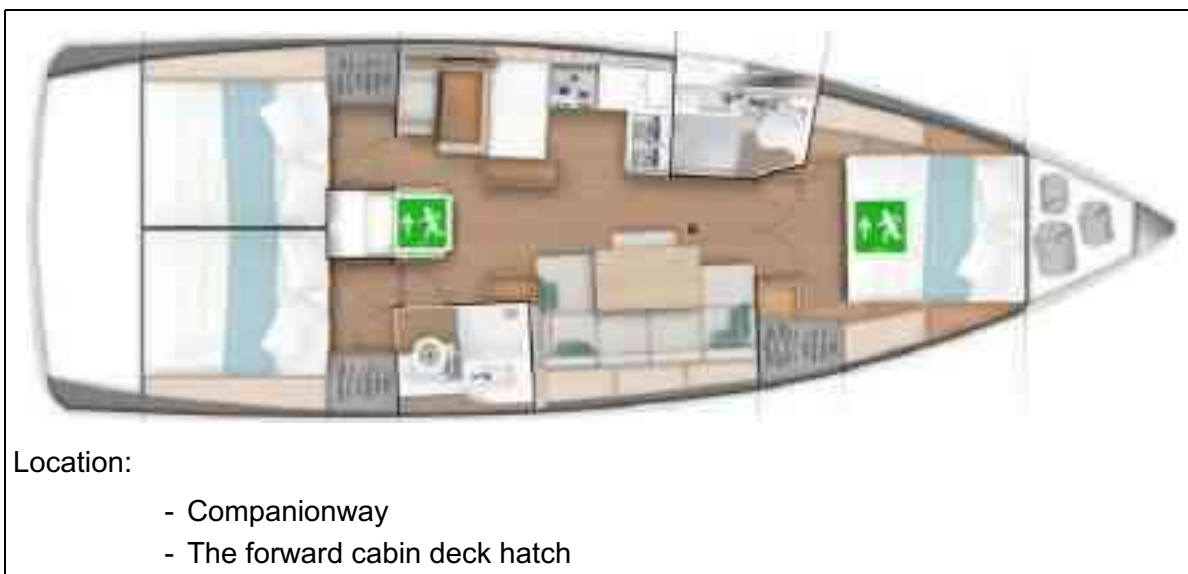

Location:

- Companionway
- The forward cabin deck hatch

### Deployment of the steps for the forward cabin's emergency exit:



#### NEVER:

- Obstruct the passages leading to the emergency exits and the hatches;
- Obstruct or block safety controls, for instance fuel shut off valves, gas taps, electrical system circuit-breakers;
- Obstruct the access to the portable extinguishers stored in lockers;
- Leave the boat unsupervised when cooking equipment and/or heating equipment is in use;
- Modify any of the boat's installations (especially the electrical, fuel or gas installations) or allow unqualified personnel to proceed with modifying these installations;
- Fill the fuel tanks or replace gas bottles while the engine is running or while cooking or heating equipment is in use;
- Use gas lamps in the boat;
- Smoke when handling fuel or gas.







## 8 ELECTRICAL SYSTEM

### 8.1 GENERAL INFORMATION ABOUT THE ELECTRICAL SYSTEM



ELECTRICAL SYSTEM

Reference	Designation
1	Engine battery, Generator battery, General fuse DC system, Power distributor, Generator battery charger
2	Battery switch, Circuit breakers
3	Chart table switches, Touch screen, DC component circuit breakers
4	Service batteries, Additional service batteries
5	Bow thruster batteries



- The risks of fire or explosion may result from careless use of the DC and AC systems.
- The risks of electrocution may result from careless use of the AC system.



**NEVER:**

- work on a live electrical system;
- modify the electrical system of the vessel or the relevant diagrams: It is important that the installation, maintenance and any modifications be carried out by a technician qualified in marine electricity;
- change or modify the strength of the safety devices protecting against power surges;
- install or replace electrical equipment or materials with components which exceed the system's nominal electrical power capacity;
- leave the boat unsupervised when the electrical system is live, apart from when the automatic bilge pump and the boat's fire protection and security systems are in use (if the boat has one).

## 8.2 DC INSTALLATION (12 V OR 24 V)

### 8.2.1 Battery use and distribution

#### General points

The boat is equipped with a direct current electrical system.

The boat's electrical system comprises service batteries and the engine battery or batteries. The service batteries serve as the power supply for all the boat's electrical components. The "engine" battery is used only for powering the electric starter of the propulsion engine.

The boat may also be equipped with:

- a generator powered by its own battery;
- a bow thruster, powered by its own battery bank.

the batteries are charged either by a load distributor or:

- by the alternator linked to the engine when the engine is running,
- by the battery charger (if the boat has one).

It is imperative that when the boat is first launched, a professional engineer connects the batteries.

Always check the condition of the batteries and charge system before putting to sea.

The battery banks are isolated from one another by a charge divider (see below).

Battery set

Engine battery: 1 x 120 A

Location: Port aft cabin



Generator battery: 1 x 50 A



Service batteries: 2 x 115 A  
Spare service batteries: 2 x 115 A  
Location: Starboard aft cabin



---

Propeller battery: 1 x 50 A

Location: Sail locker



### Maintenance

- Avoid charging batteries to a voltage greater than 14,6 V.
- Keep the batteries clean and dry.
- Regularly check that the terminals and connection cables are clean. If necessary, apply a thin coating of paraffin on the terminals, to prevent corrosion.
- Regularly recharge all of the batteries onboard.
- Continuously maintain the charged batteries: this determines their length of life.
- Avoid long periods of electrical inactivity (for example when wintering the boat).



- All work carried out on a battery must only be carried out by someone qualified to do so. Whenever working on a battery, wear safety goggles and protective clothing.
  - Never smoke or produce a spark near a battery: risk of an explosion.
  - If any acid accidentally splashes on your skin or in your eyes thoroughly rinse it off immediately with fresh water. See a doctor immediately.
  - Never touch the battery terminals: danger of electric shock.
  - Refer to the manufacturer's instructions for use and maintenance.
- IT IS IMPERATIVE TO DISCONNECT THE BATTERY CHARGER BEFORE DISCONNECTING THE BATTERY TERMINALS FOR MAINTENANCE.**



### Maintenance of lead batteries

- Every year check the water levels in the batteries, and if they are low top them up with distilled water.
- Keep all metallic objects away from the batteries.
- Lead batteries contain sulphuric acid: Be careful not to knock them over whenever handling them.

### Maintenance of watertight batteries

- This type of battery needs no maintenance and does not produce any gas during normal use. No ventilation is needed.
- The optimum temperature for use is between 10 degree C and 30 degrees C. Lower temperatures will reduce the available capacity. Higher temperatures will increase the batteries' self-discharge rate.
- Never open watertight batteries.
- Never add acid or distilled water.
- The pressure valves are used to seal the batteries and cannot be opened without being destroyed.
- If the batteries overheat, a build-up of gas may develop: Keep away from the batteries.

---

## 8.2.2 Battery switch

- Manual battery switches: to make the system live, manually turn the positive and negative battery isolator switches.

Positive battery isolator switch



Battery switch of negative terminal



Location: Port aft cabin



1. Engine battery's positive isolation switch
2. Common battery negative isolator switch
3. Service batteries positive isolation switch





- Electrically controlled battery breakers: press the switches on the breaker control panel. In the event of electrical failure, it is possible to press down the button on top of the battery breaker manually to activate it.

The electrically-controlled battery breakers use very little electricity when they are on: **It is imperative to turn off all the battery breakers during lengthy absences, to prevent the batteries from slowly and irreversibly discharging.**

The engine's positive battery isolator automatically comes on and goes off when the engine is started/stopped.

The negative of the circuit is connected to the general negative.

Location: Sail locker



---

### 8.2.3 Power distributor

- The electronic charge dividers isolate the battery banks from each other and allow the charge to be directed automatically to the battery with the lowest charge. They give the advantage of preventing a drop in voltage.
- The charge divider is electronic. It is designed to distribute the charging current with a low voltage drop between the battery banks (engine and service batteries). It prevents the current from circulating from one battery to another. When the voltage of the charger or alternator is available, the charge divider's green indicator comes on.

Location: Port aft cabin  
Capacity: 150 A



## 8.2.4 Battery charger

### General points

- The battery charger runs on AC power.
- A breaker protects the electrical circuit.
- The battery charger charges all of the batteries onboard, while keeping the service battery bank isolated from the engine's battery bank.



### Operation

- The charger runs fully automatically. It can remain permanently connected to the batteries and does not need to be disconnected when starting the engine.
- In some electrical circuits, there may be battery chargers coupled in parallel.

### Maintenance

- Before doing any maintenance, cut the AC supply.
- Regularly vacuum out any dust particles which may accumulate in the charger. An annual check of the tightness of the nuts and bolts is necessary to ensure the correct operation of the charger.



**IT IS IMPERATIVE TO DISCONNECT THE BATTERY CHARGER BEFORE DISCONNECTING THE BATTERY TERMINALS FOR MAINTENANCE.**

## Layout diagram - Battery cables

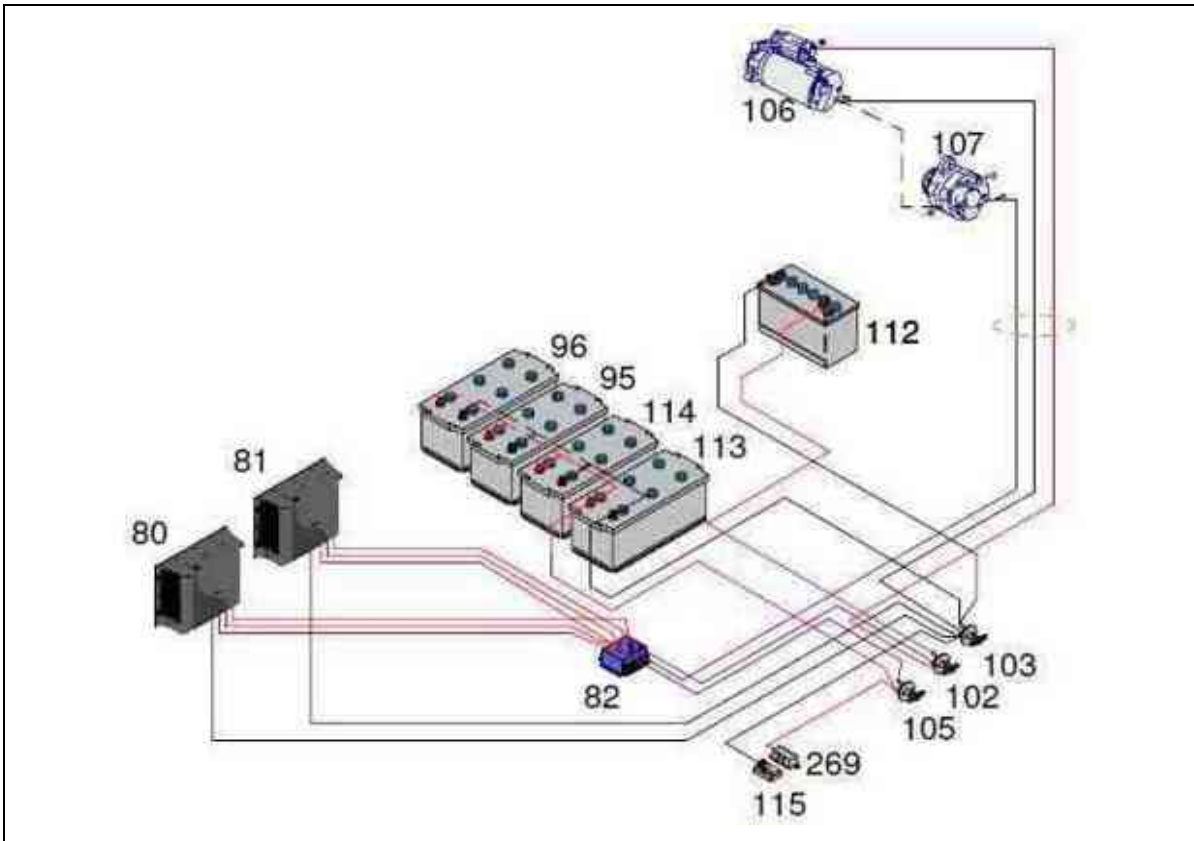

Reference	Designation
80	Battery charger
81	Battery charger (additional)
82	Power distributor
95	Spare service battery
96	Spare service battery
102	Engine battery's positive isolation switch
103	General negative battery isolation switch
105	Service batteries positive isolation switch
106	Alternator
107	Electric starter
112	Engine battery
113	Service battery
114	Service battery
115	Shunt (used to measure current)
269	General fuse for 12 V circuit

### 8.2.5 Layout of the wiring looms in the hull - DC circuit

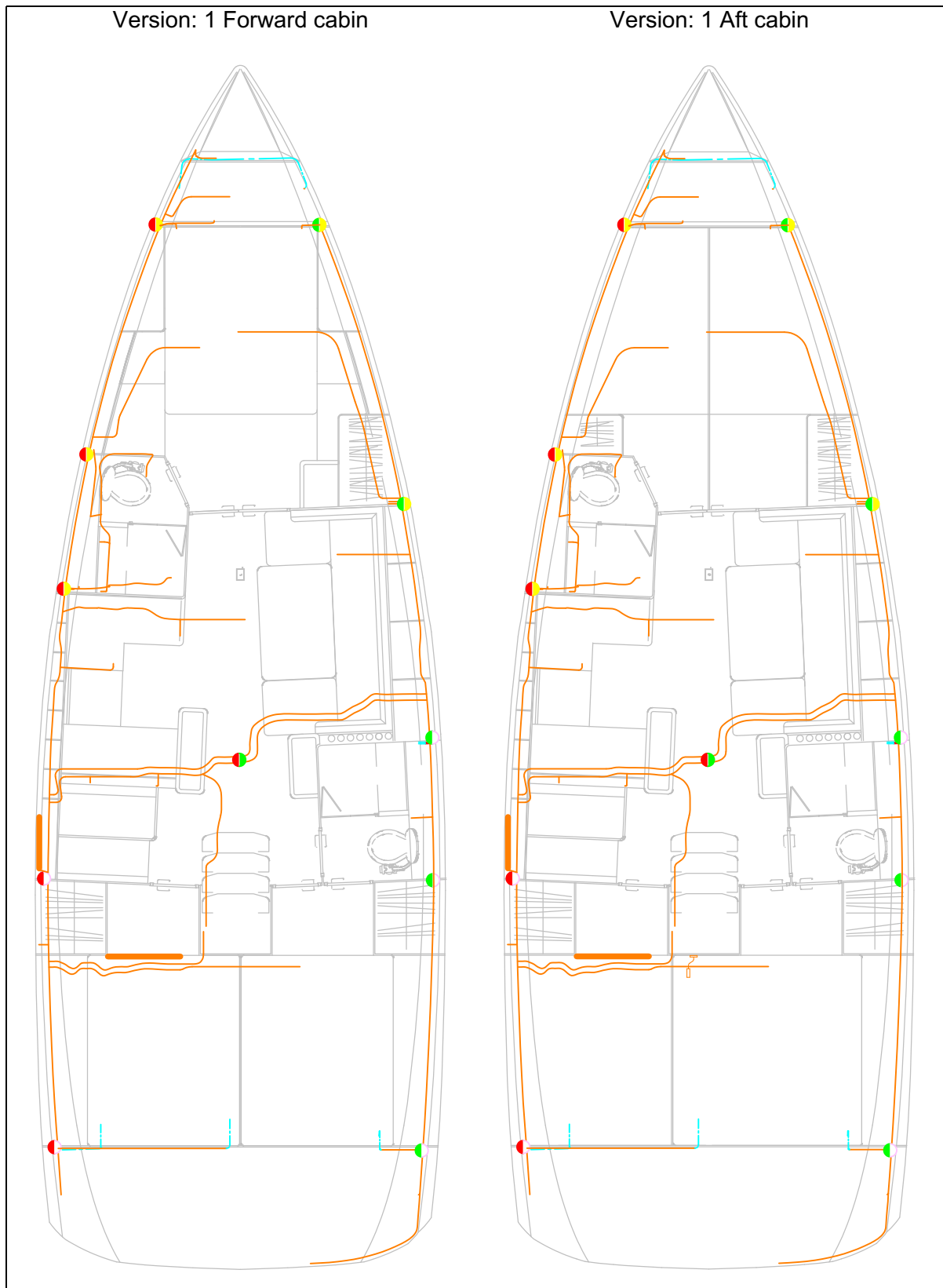

---

## 8.2.6 Layout of the deck wiring looms - DC circuit

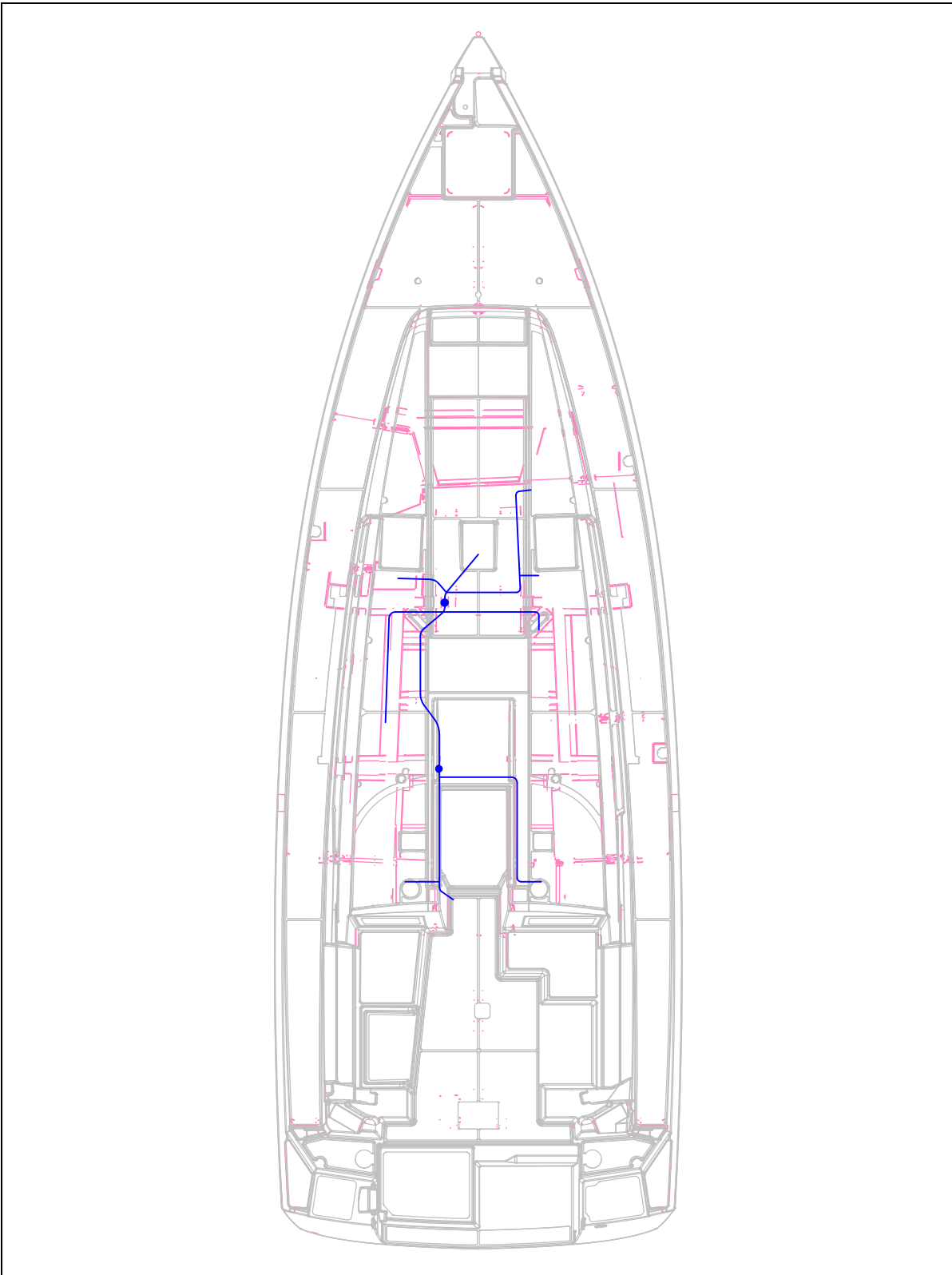

## 8.2.7 Electrical panel

Location: Chart table

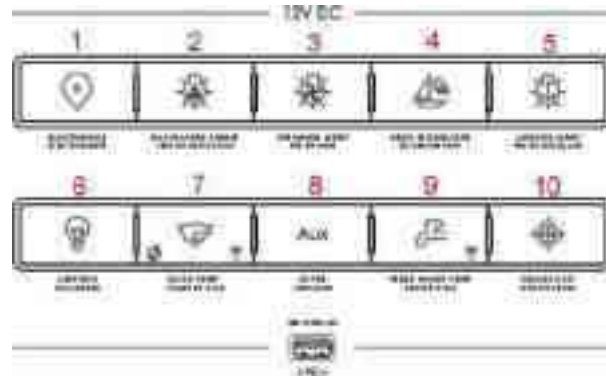

1. Electronic instruments
2. Navigation lights
3. Steaming light
4. Deck light
5. Mooring light

6. Interior lighting
7. Electric bilge pump
8. Available
9. Water unit
10. Refrigeration unit

**NOTE: The 10 silicone keys switch on the desired DC elements via relays.**

Location: Cockpit table

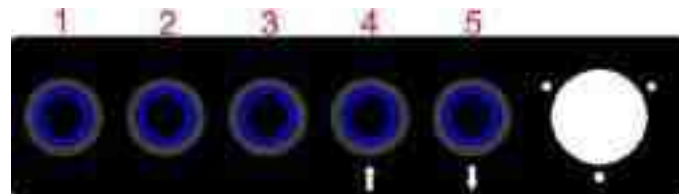



1. Lighting - Cockpit table
2. Lighting - Night lamps
3. Lighting - Cockpit
4. Controls raising of platform
5. Controls lowering of platform

## 8.2.8 Circuit breakers

A circuit-breaker can be re-set (manually press the black button to restart it).

Access: Back of electrical panel









<ol style="list-style-type: none"> <li>1. 12 V socket - Hull (Electrical panel) &amp; 12 V socket - Deck (Cockpit table)</li> <li>2. Hifi &amp; TV Antenna</li> <li>3. Supply - Touch screen</li> <li>4. VHF &amp; AIS</li> <li>5. Draining pump for shower (Forward head)</li> <li>6. Draining pump for shower (Aft head)</li> <li>7. Electric toilet (Forward head)</li> </ol>	<ol style="list-style-type: none"> <li>8. Electric toilet (Aft head)</li> <li>9. Gas solenoid (US Version)</li> <li>10. Deck wash pump</li> <li>11. Refrigeration unit for icebox (Galley)</li> <li>12. Fridge (Galley)</li> <li>13. Refrigeration unit for icebox (Cockpit)</li> <li>14. Supply - Windlass</li> <li>15. Supply - Bow thruster</li> <li>16. Supply - Aft platform</li> <li>17. Alarm - Aft platform</li> </ol>
--	--

Location: Port aft cabin



1. Electric windlass
2. DC/AC converter
3. Genoa electric winch



### 8.2.9 Fuses

- A fuse protects an electrical circuit from a power surge. If it blows, you must replace it with another fuse of the same rating.

Access: Back of electrical panel



- Fuses - Electronic instruments
- Navigation screen
- HUB
- Auto pilot
- GPS

Location: Port aft cabin

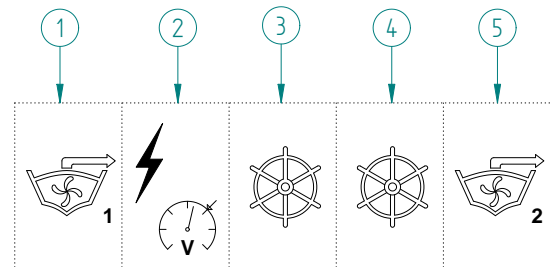

1. Ventilator - Engine compartment
2. Electronic
3. Plus after contact - Motor
4. Generator
5. Easy sailing

Fuse DC circuit protection  
Location: Port aft cabin



When replacing fuses/circuit-breakers, always ensure replacements are of the right capacity (see the colour-codes)



20A

15A

10A

5A

3A

### 8.3 TOUCH SCREEN

The touch screen allows the boat's auxiliary functions to be driven and displayed:

- Battery voltage,
- Fresh water gauge.
- Management of boat's AC supply sources.

Location: Chart table



## Layout diagram

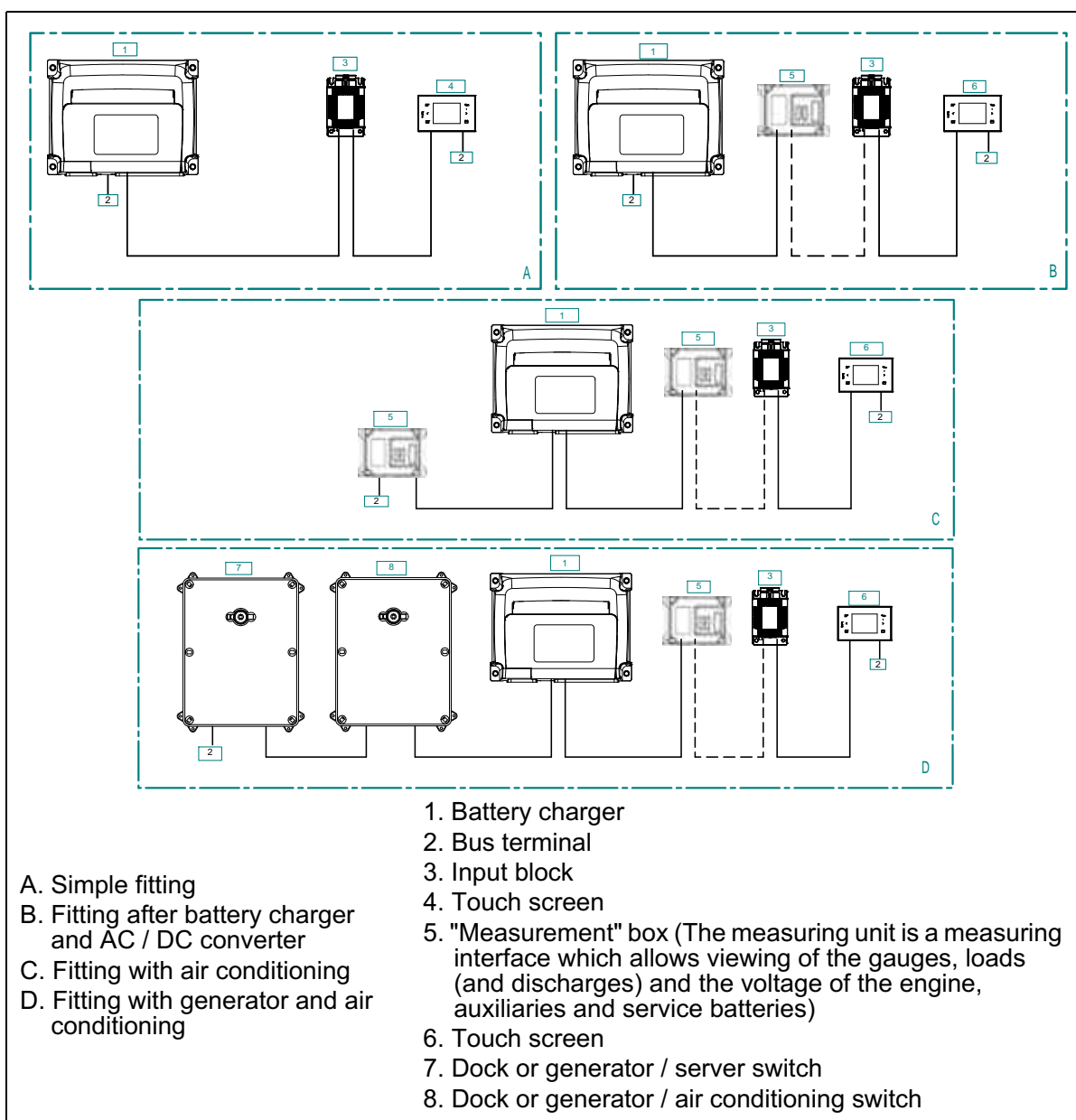

---

The screen NAVICOLOR is a touch interface for viewing and controlling the auxiliary functions of the boat:

- Fuel level,
- Fresh water level,
- Grey water level,
- Black water level (WC),
- Battery voltage,
- Wireless lighting,
- Starting the generator,
- Management of boat's AC supply sources,
- Network viewing and diagnostics.

### Description of elements

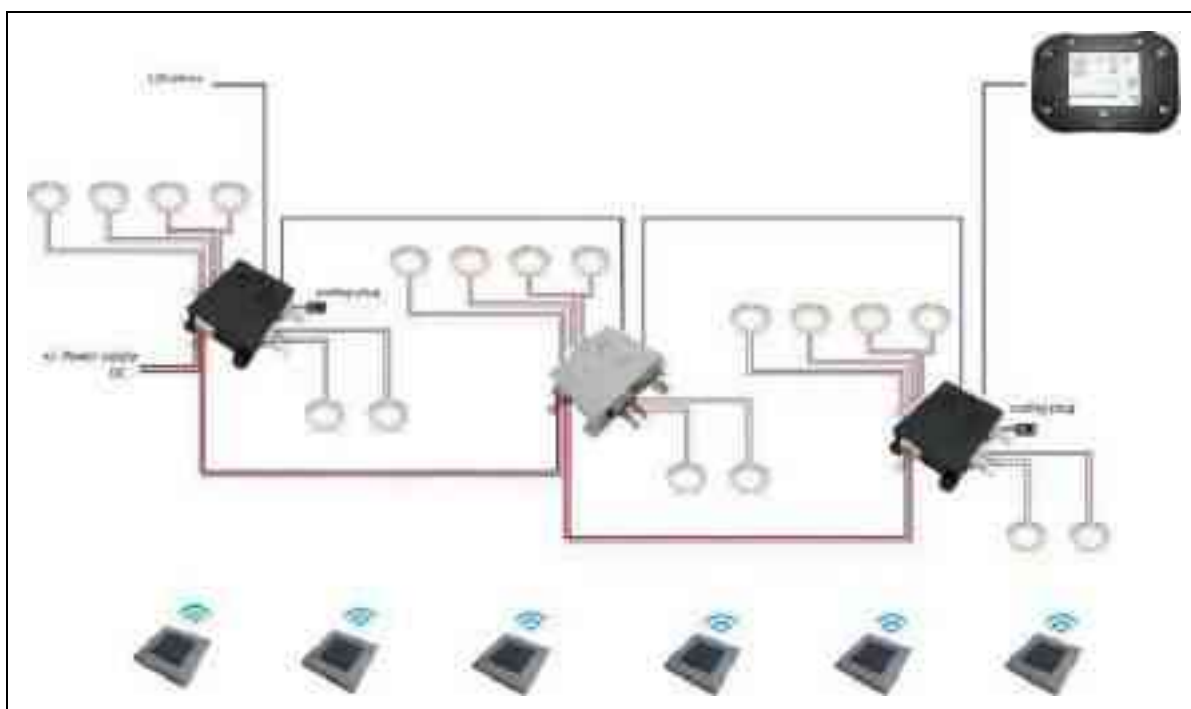

Block 7 génèrâtes a regulated voltage of 12 V on the CAN bus intended to power the touch screen NAVICOLOR.

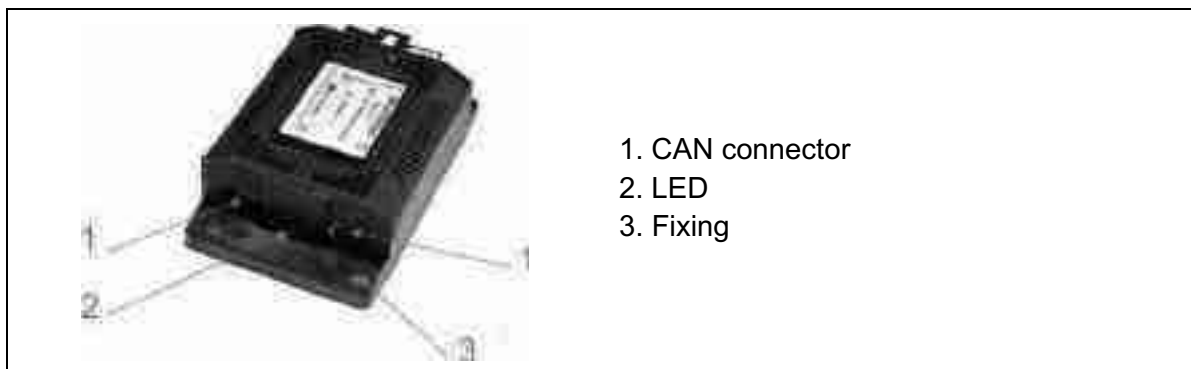

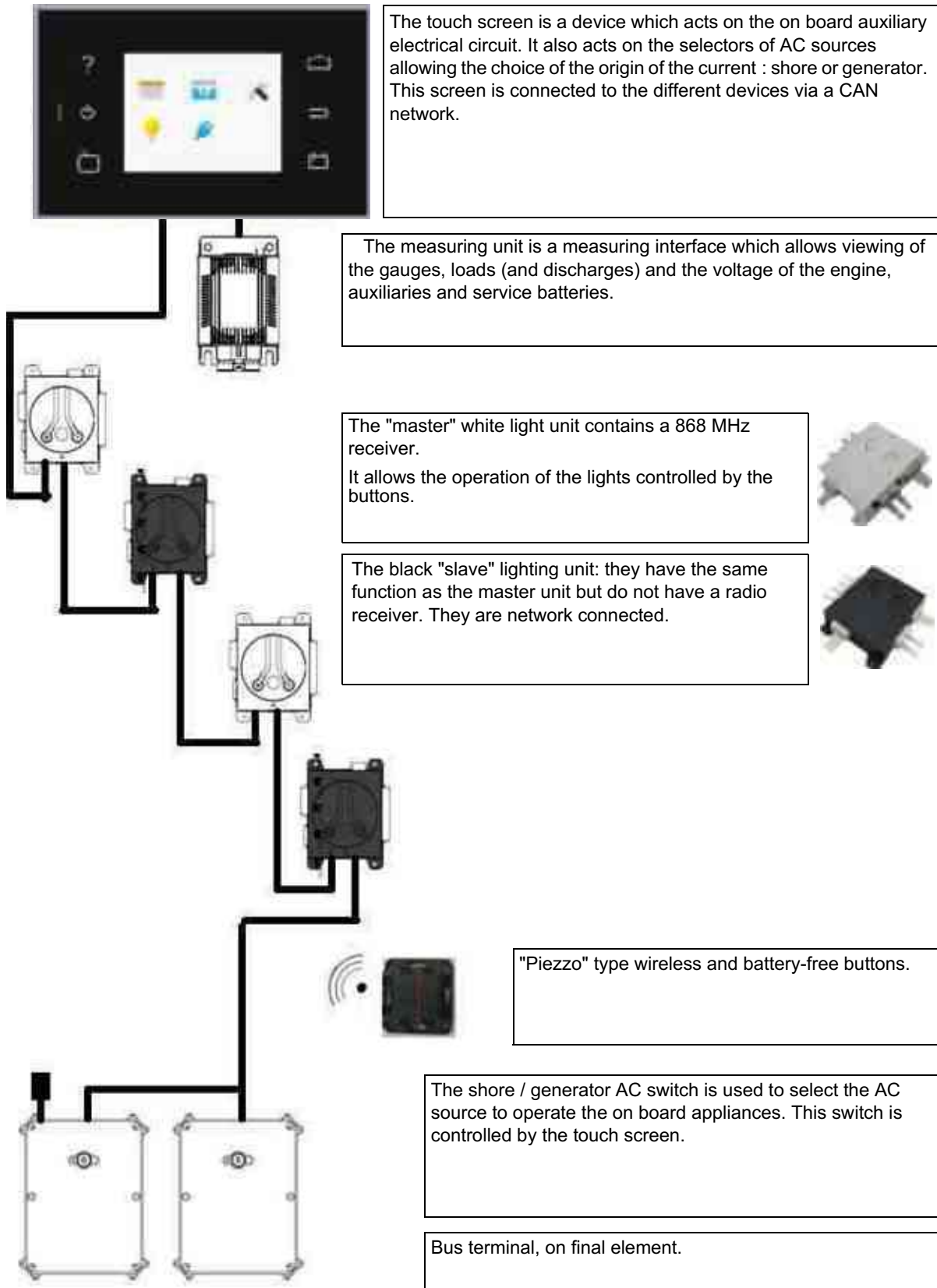

## Touch screen operation

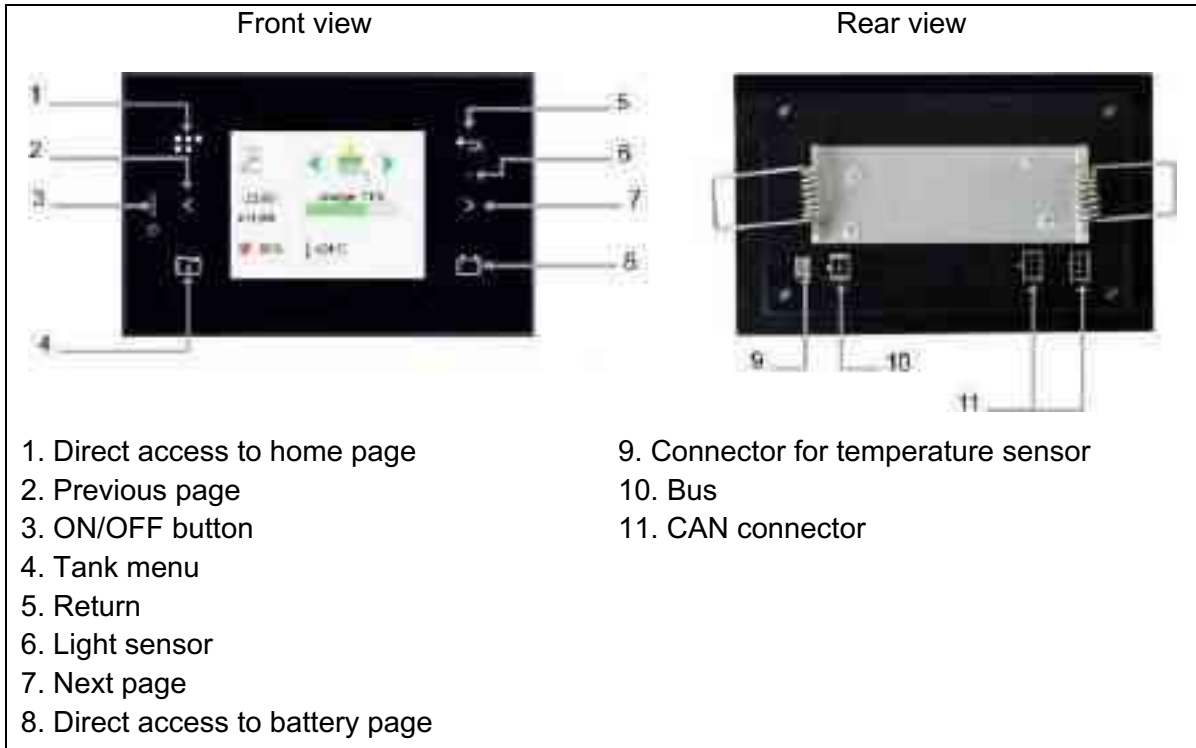

- Battery measurement menu access



- Fresh water tank level menu access



- AC supply distribution menu access



- Interior lighting menu access

- Adjustment menu access (Access to it is restricted by a code supplied on request to the yard)



- CAN network display (Controller Area Network)
- Parameterization of lighting
- Configuration of the 'gauge' pack
- Configuration of source selectors



Return to preceding page

## Operation

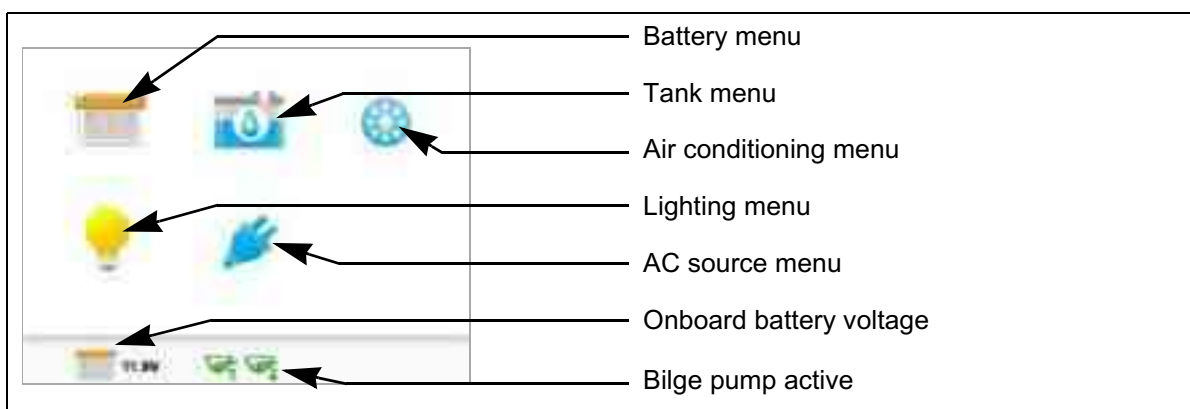

### NOTES

The menus may vary depending on the specific equipment of each boat.

### Battery menu



A press of the finger on the required menu icon allows access to a sub-menu.

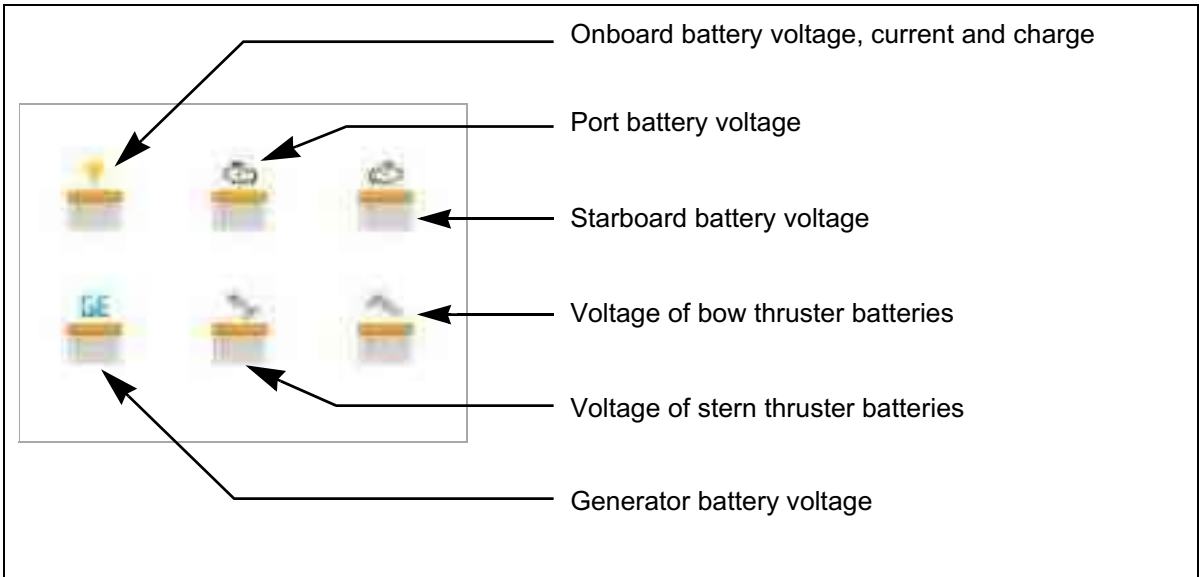

examples:

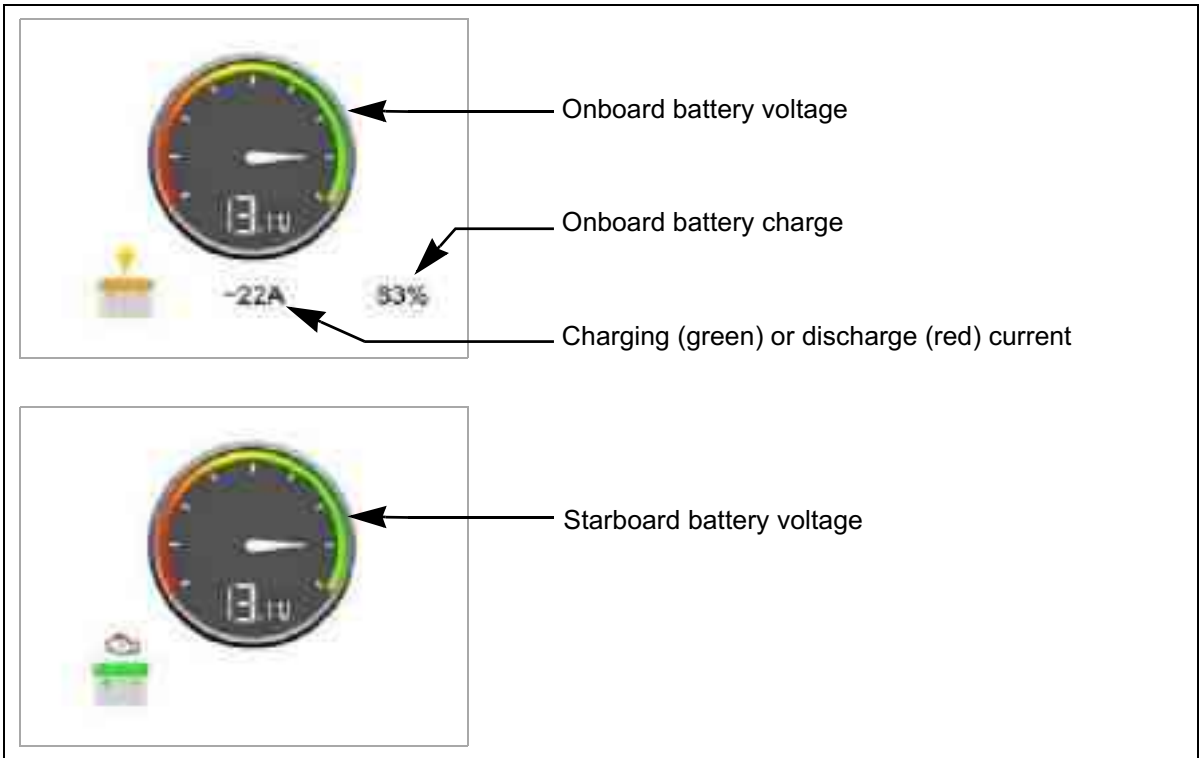



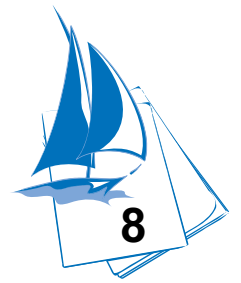

### Tank menu



A press of the finger on the required menu icon allows access to a sub-menu.

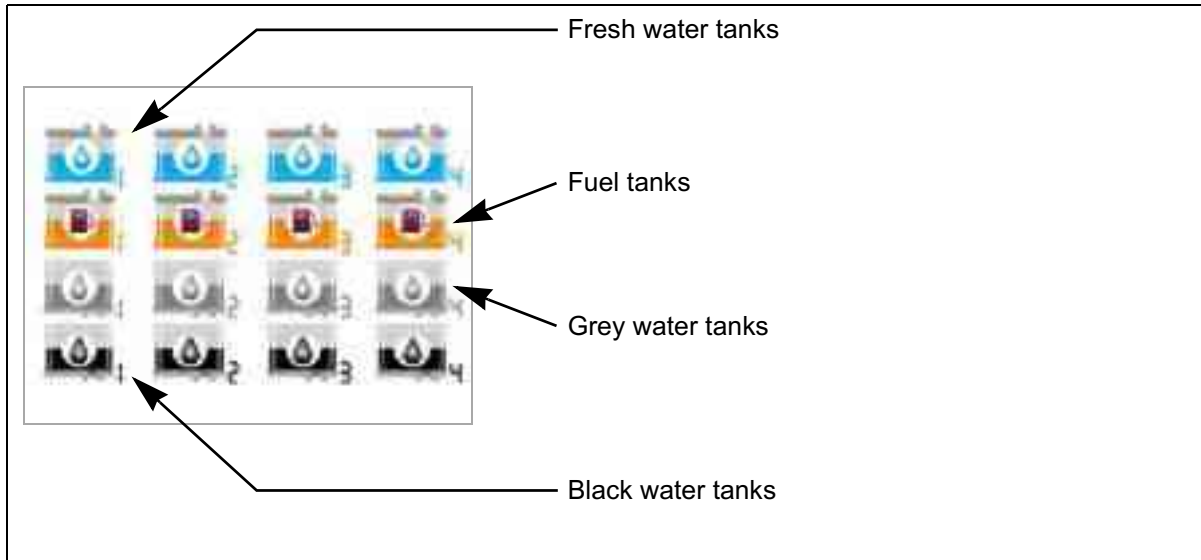

examples:

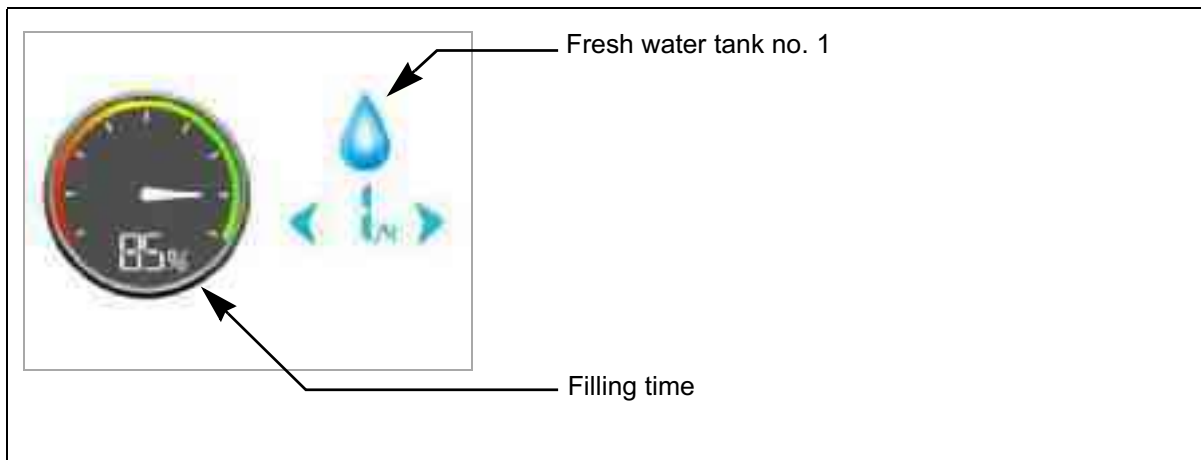

---

## Air conditioning menu

The Navicolor controls the air conditioning in the saloon.

**NOTE: Ship Control also allowing it.**

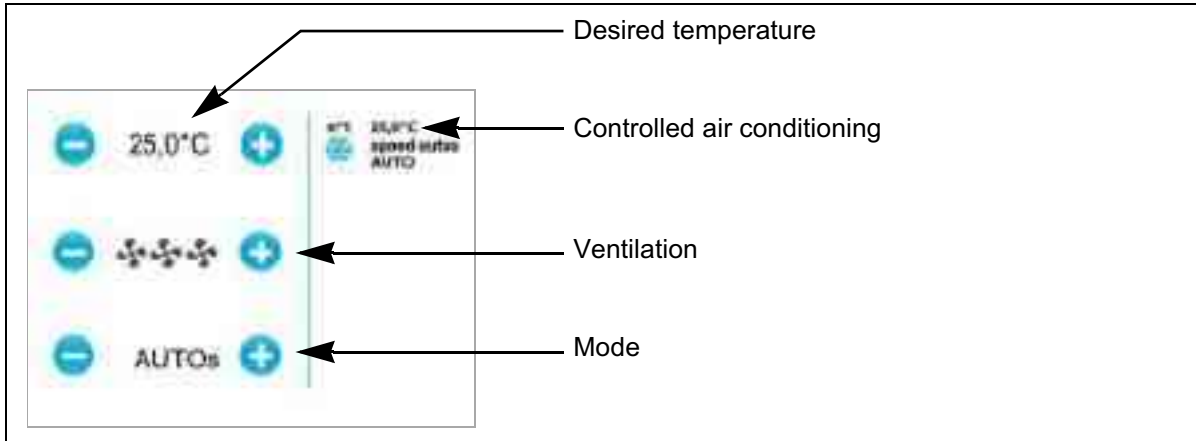

## Lighting menu



A press of the finger on the required menu icon allows access to a sub-menu.

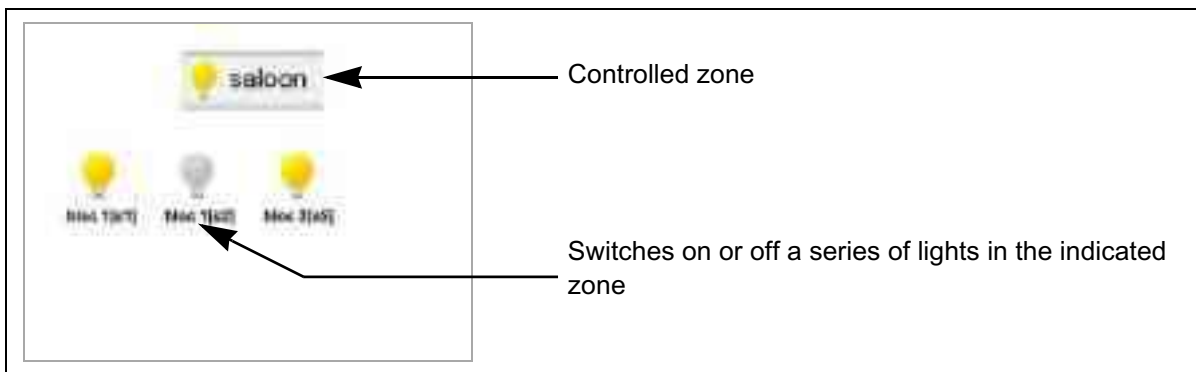
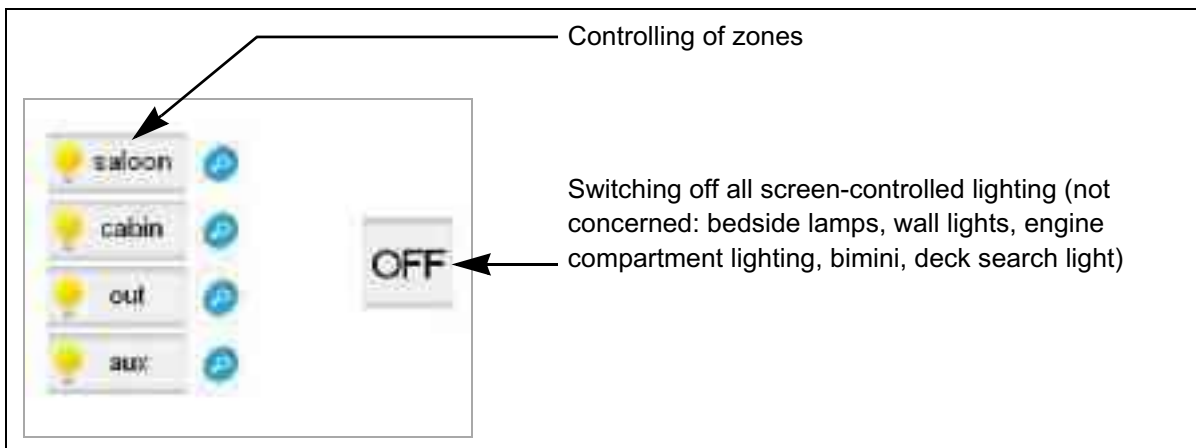

### AC source menu



A press of the finger on the required menu icon allows access to a sub-menu.

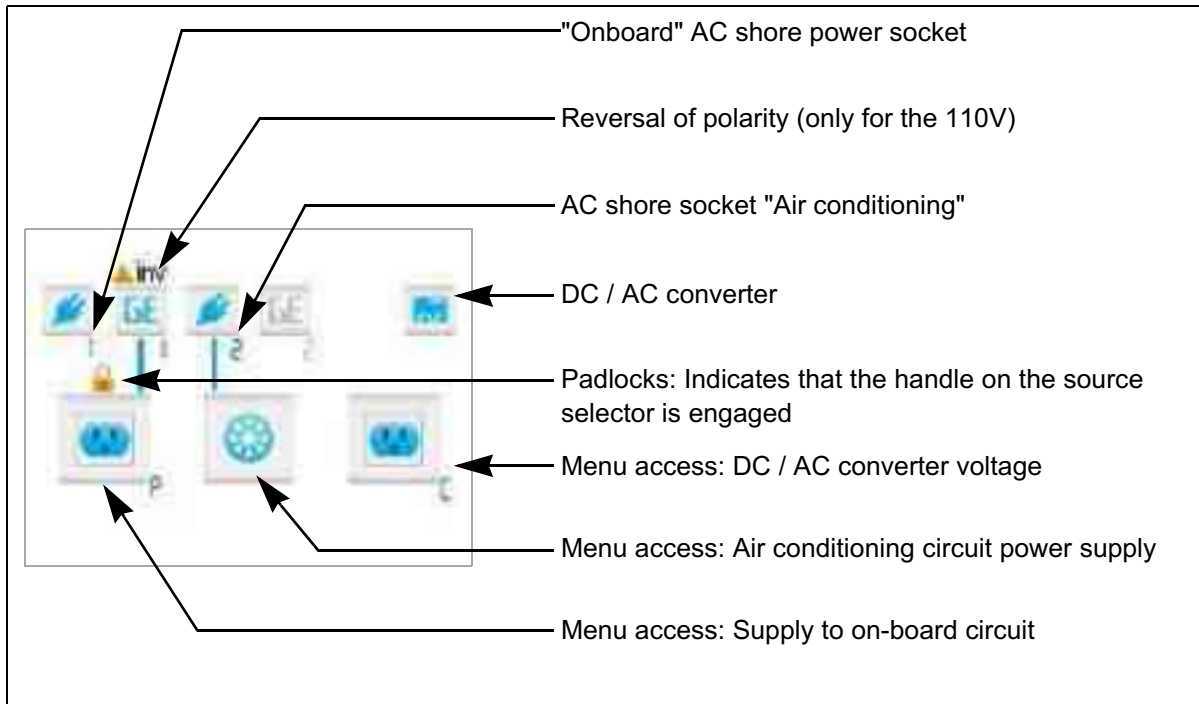

## AC source menu

Pressing the shore power socket button or generator runs the switching of the selector. The orange circle indicates that the switch is made.

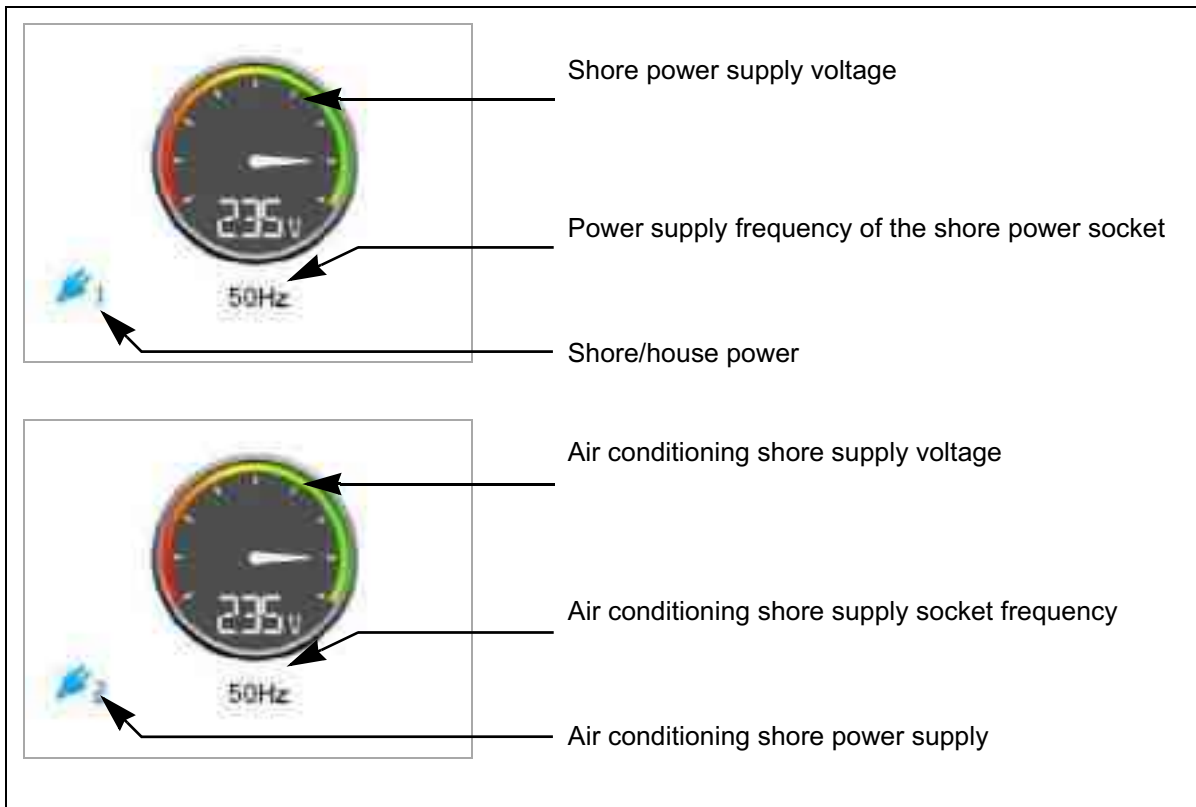
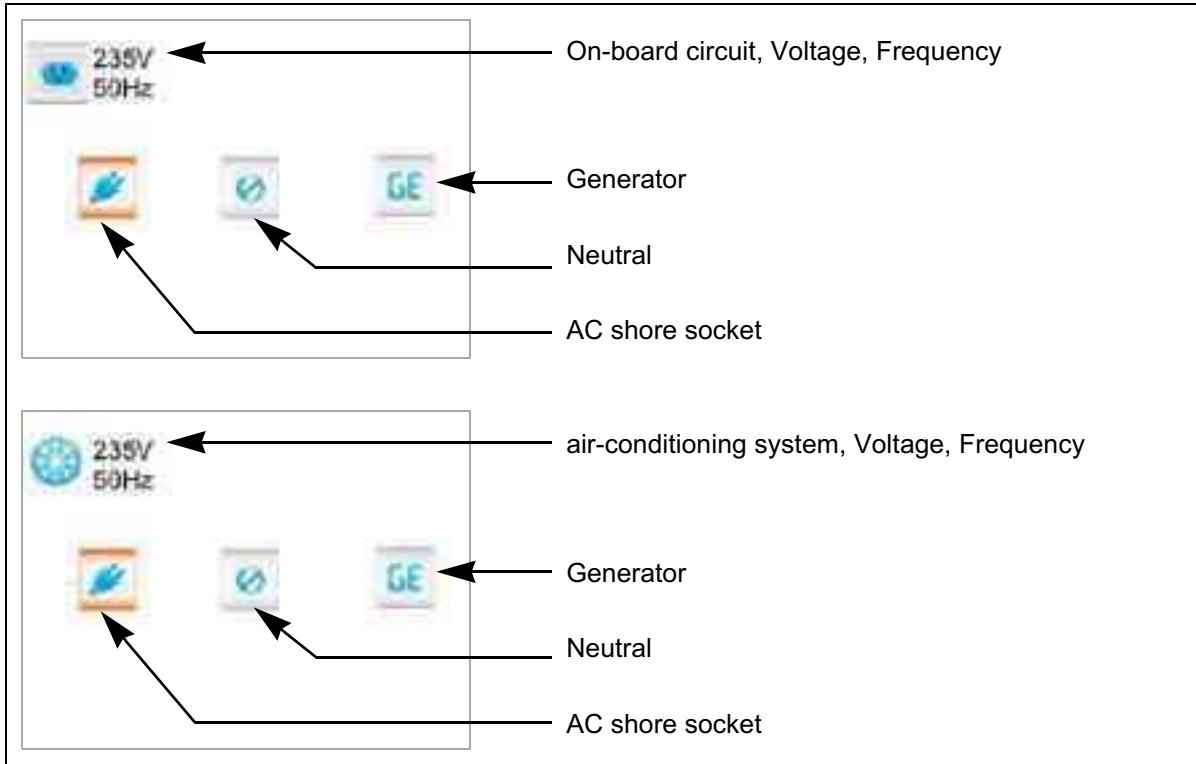

**AC source menu**



- Output voltage of the DC/AC converter
- Output frequency of the DC/AC converter
- DC/AC converter



- Voltage supplied by the generator to the on-board power supply
- Generator ON / OFF
- Generator supply frequency on board
- On-board AC



- Voltage supplied by the generator to the on-board power supply
- Generator ON / OFF
- Generator supply frequency on board
- On-board AC

---

## Removal

The touch screen can be removed for maintenance by a slight manual pressure which removes it from its support.





## 8.4 AC SYSTEM (110 V OR 220 V)

### 8.4.1 General points

- The boat is equipped with an alternating current electrical system.
- The electrical system of the boat consists of an AC shore socket and if appropriate:
  - 1 Generator,
  - 1 DC/AC converter.
- The AC electrical system is used to power the following components (if the boat has one):
  - Air conditioning,
  - Household appliances,
  - Water heater,
  - Interior AC sockets,
  - Battery charger(s).

### Recommendations for using the AC electrical system correctly

- Do not modify the vessel's electrical installation nor its relating diagrams. The installation, maintenance and any modifications must be carried out by an electrician qualified in marine electricity. Have all electrical installations checked (tightening and connections) every year.
- Disconnect the boat's shore power when the system is not in use.
- Connect the relay cans or metal casing of the electrical equipment installed to the boat's protective conductor (green or green with yellow stripe conductor).
- Use double insulated or earthed appliances.
- If the reverse polarity indicator is activated, do not use the electrical installation. Rectify the polarity fault before using the vessel's electrical installation (this applies only to polarised circuits with a polarity indicator).



- If a DC/AC converter is fitted on board: it is essential to switch off the DC and AC circuits before working on the cabin AC sockets.



- Never let the end of the boat/shore supply cable hang in the water: The result may be an electric field liable to hurt or kill the swimmers nearby.
- There may be danger of electrocution if alternating current systems are incorrectly used.
- Do not work on a live AC system.



To reduce the risks of electric shock and of fire:

- Turn off the shore supply with the onboard cut-off switch before connecting or disconnecting the vessel/shore supply line.
- Connect the ship/shore power cable on the boat before plugging it into the socket onshore.
- Disconnect the ship/shore power cable at the shore socket first.
- If the reverse polarity indicator is activated immediately disconnect the cable.
- After using the socket onshore, close its protective cover tightly.
- Do not modify the connections of the ship/shore power cable: only use compatible connections.

**DO NOT MODIFY THE CONNECTIONS ON THE SHIP/SHORE POWER CABLE.**

### **ADVICE-RECOMMENDATION**

Every month, you are advised to test the circuit breaker or residual current differential switch that can be recognised by its "test" button.



## 8.4.2 AC shore socket

### location of components



Ref 1: AC shore socket



Ref 2: Bipolar circuit breaker (Protection)



---

Ref 3: Differential switch (Operation)



### Operation

First plug the extension cable into the AC socket on the boat, then into the socket onshore.

First unplug the extension cable from the socket onshore, then from the AC socket on the boat.

Control:

- The winder is unwound manually.
- The winder is wound electrically.

Electric furler - Shore power socket



### 8.4.3 AC source selectors



The quasi-group switch is the actuator for:

- Switching over to the different AC sources available on the boat. Including the dock socket(s) and the generator.
- measuring the voltage, frequency and current of the power sources connected to it.
- Generator start (selector no. 1 "onboard") or air conditioning (selector no. 2 "air conditioning").
- An isolated measurement (galvanic) of the generator battery.

In case of system failure, the switch can be operated manually, using the handle on the device. Engage the handle, then switch to the right or left of the device to select the chosen AC source.

Maintaining switching positions does not require power consumption.

Location





1. Source selector "House" - is fitted if the boat is fitted with a generator.
2. Source selector "Air conditioning" - is fitted if the boat is fitted with air conditioning.

Handle



Manual use



0. No selection
1. Selector #1 (House)
2. Selector #2 (Air conditioning)

## Operation

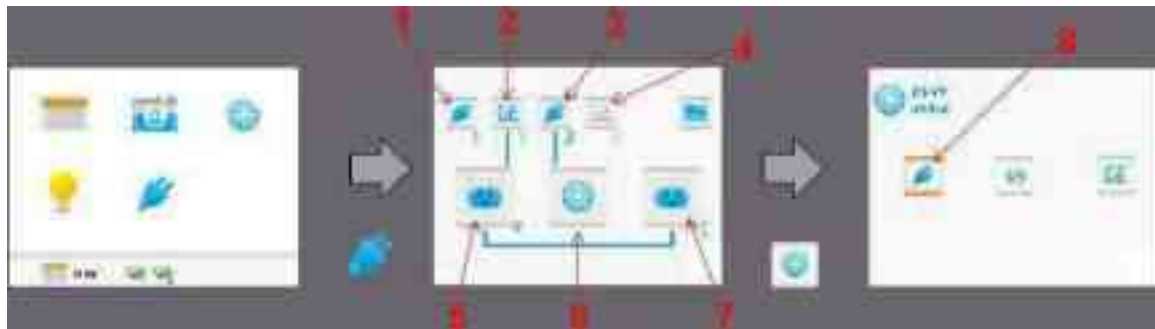

1. Shore voltage present but not selected
2. Generator on and selected
3. Current and selected platform voltage
4. Generator off
5. Selector #1
6. Selector #2
7. AC unit
8. Source selected for the onboard selector



Here on the selector 1, the padlock indicates the presence of the manual control handle on the selector. Switching is not available from the screen.

### 8.4.4 Layout diagram

#### AC electrical system

Europe Version (220 V / 50 Hz)

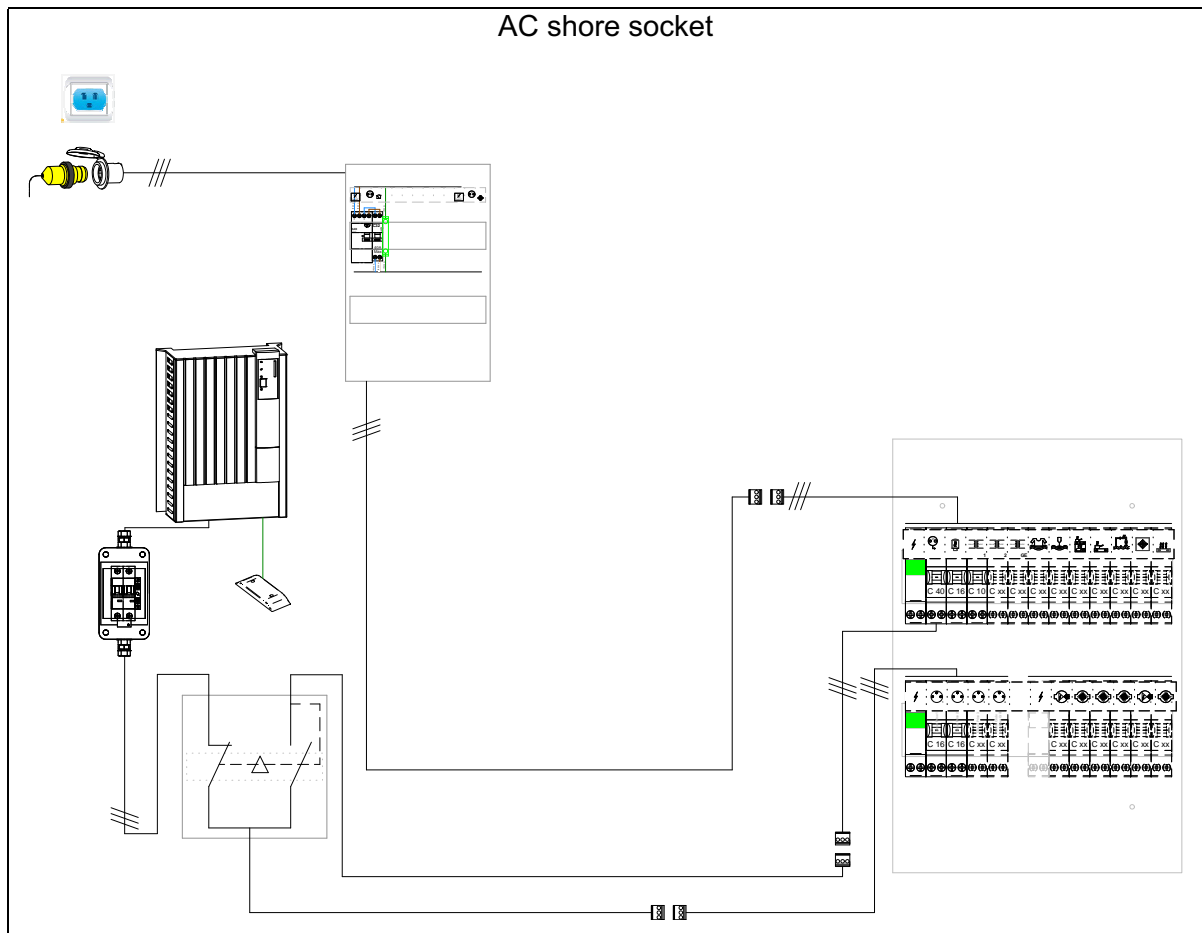

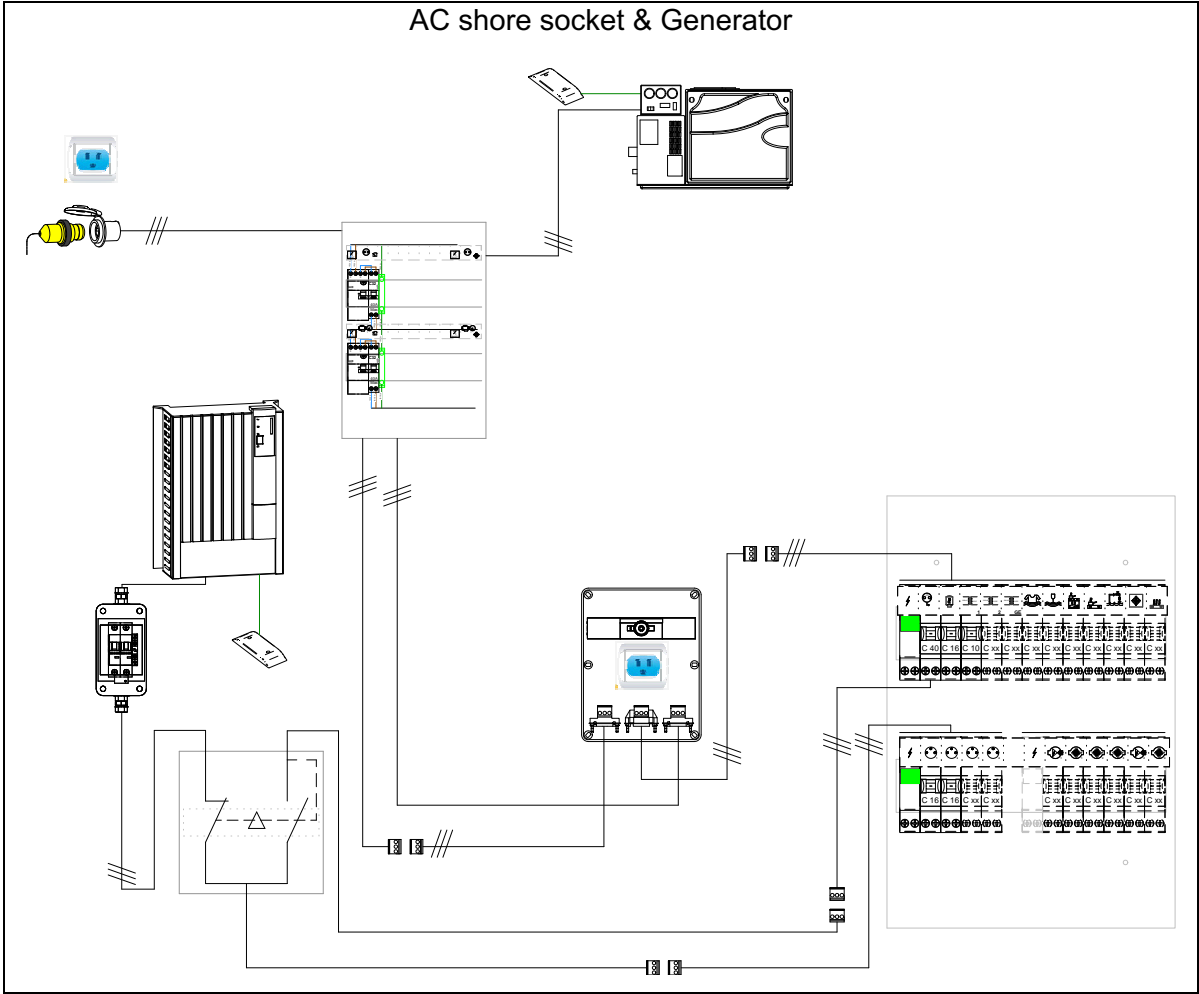

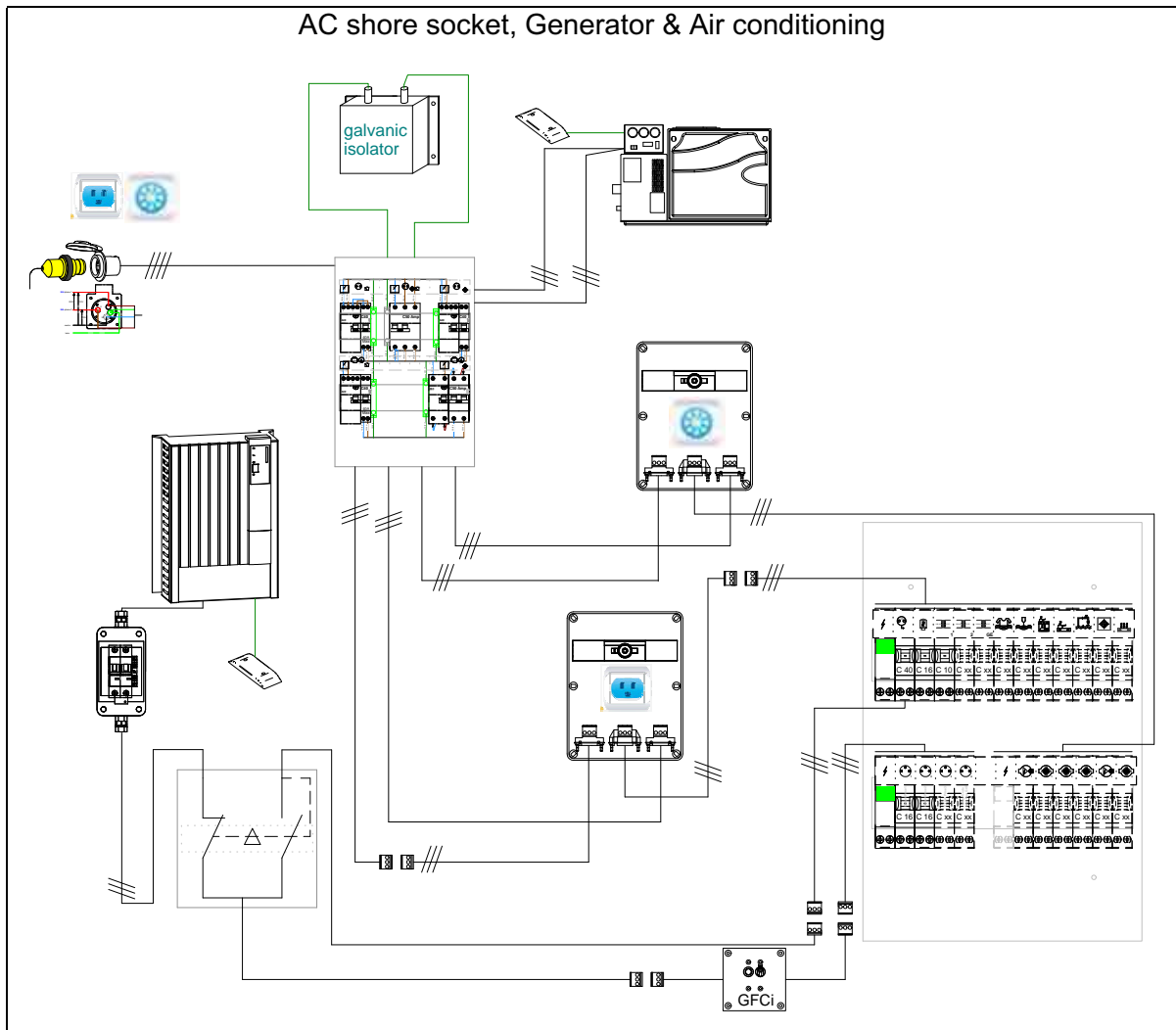

---

### **US Version (110 V / 60 Hz)**

The principle consists of isolating the earth of the boat from that of the quay using a galvanic isolator. This assembly protects the motor from electrolysis in the case of faulty insulation between the battery negative and the boat's earth.

Installation of galvanic isolators:

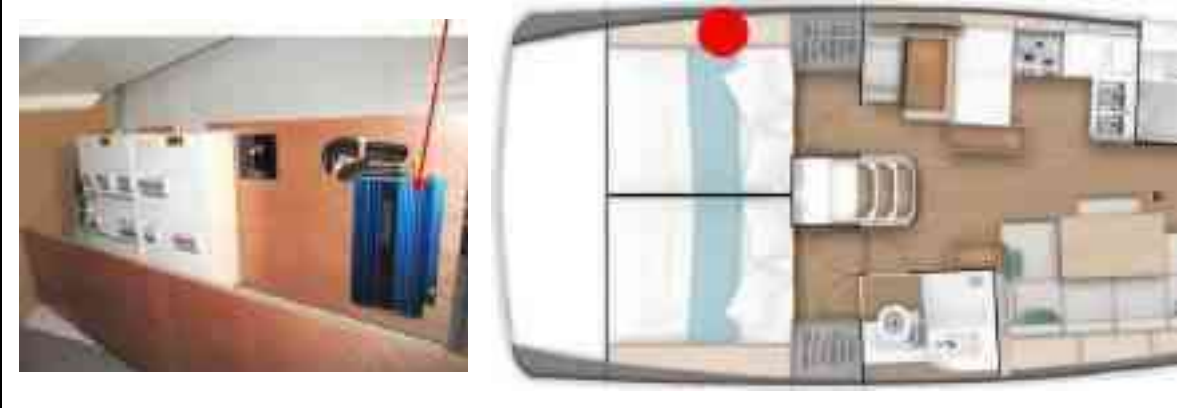



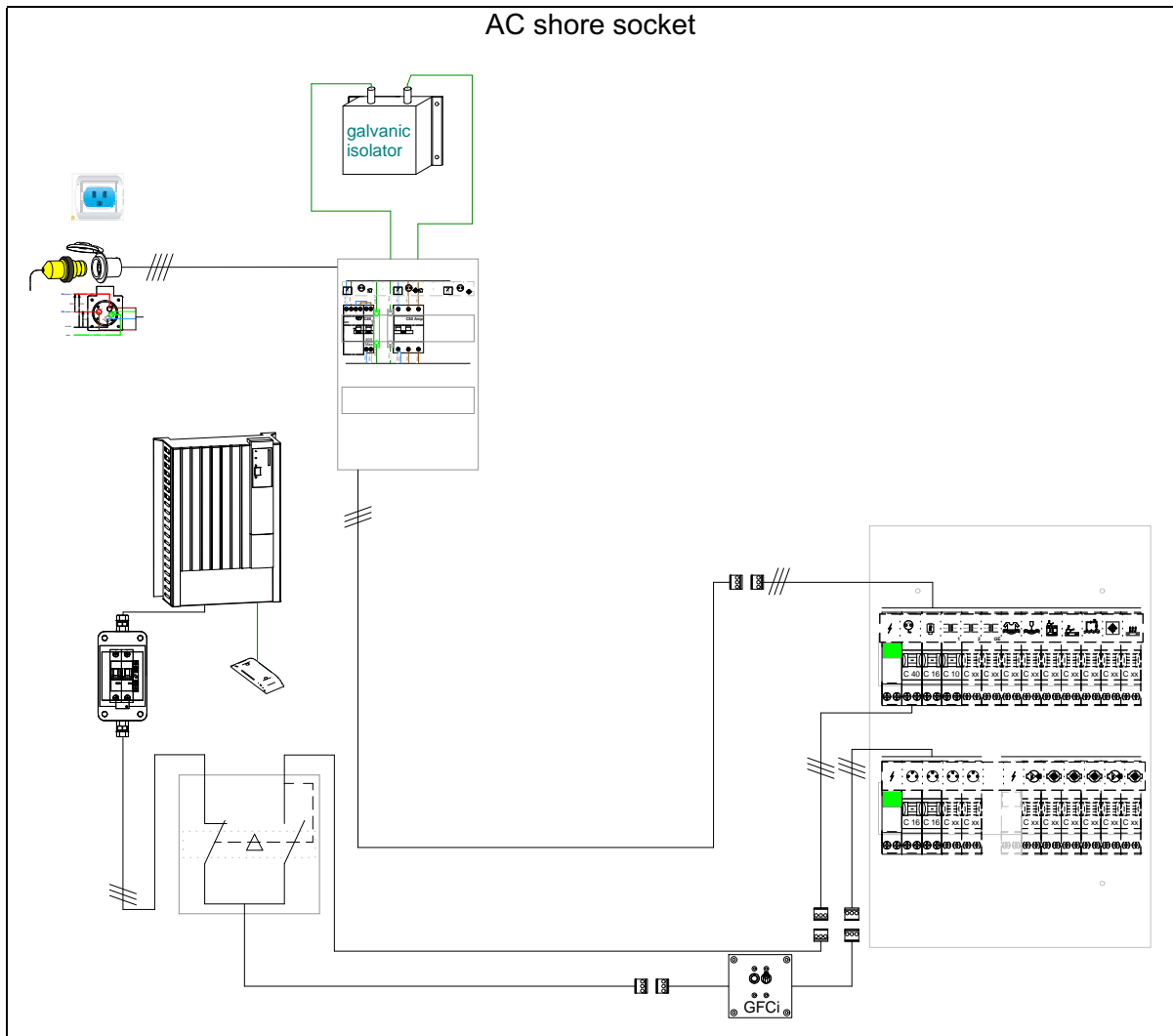

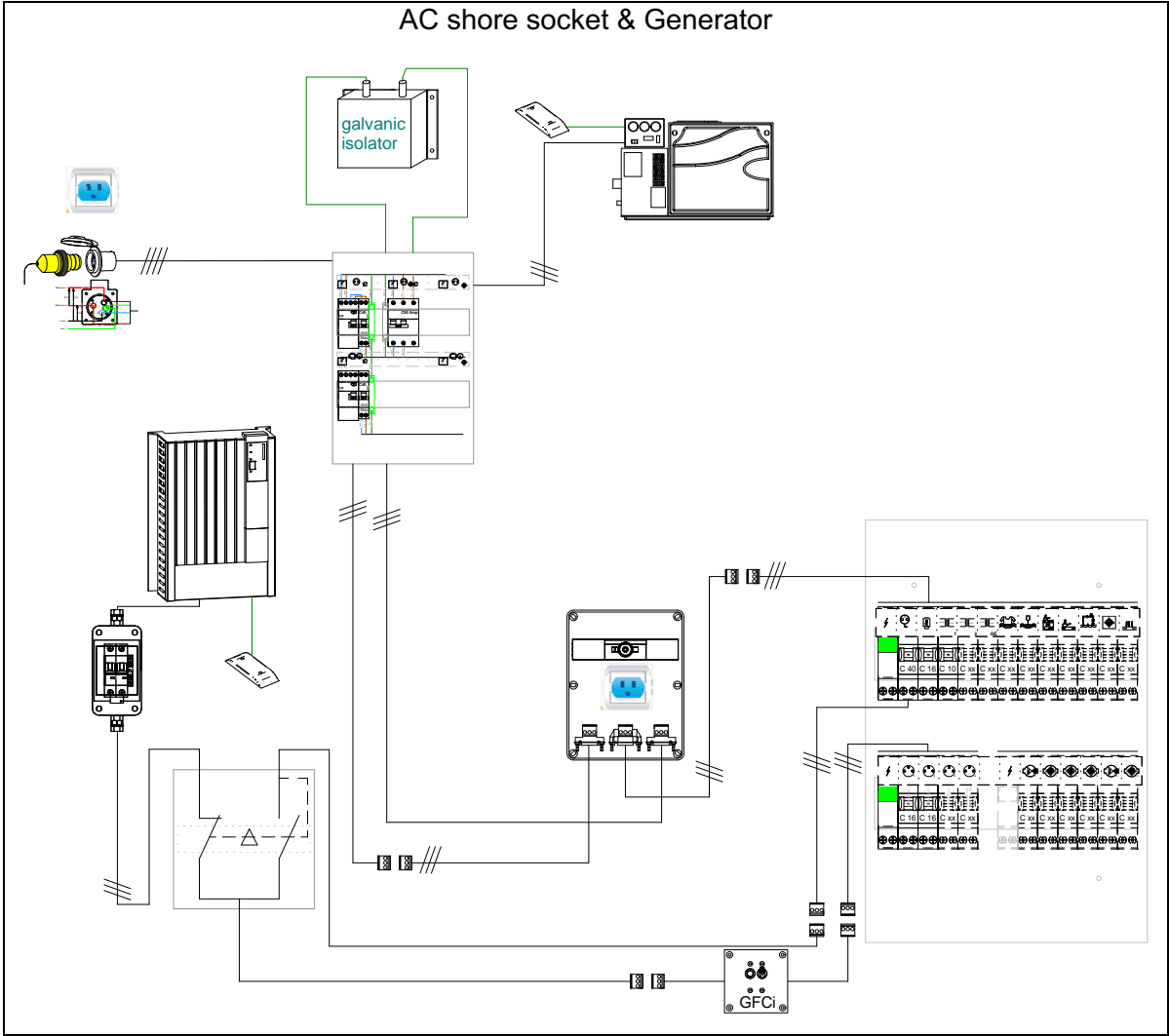

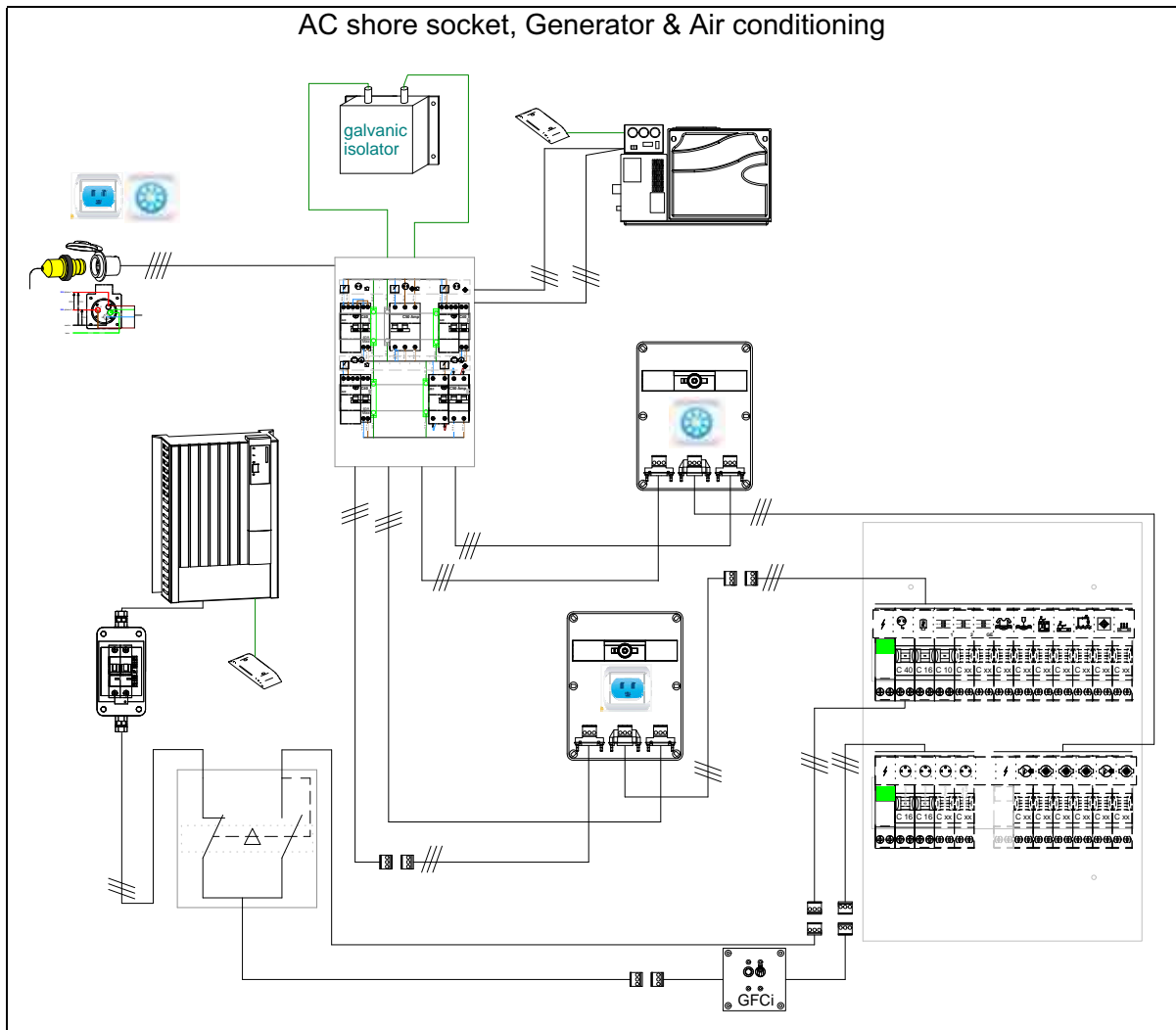

---

## 8.4.5 DC/AC converter

### Description

- The inverter converts the DC voltage of the service battery bank to AC voltage. The circuit between the inverter and the batteries is protected by a fuse or a circuit-breaker.
- The inverter is earthed by an earthing plate located under the hull (see Chapter: EARTHING PLATES).
- The voltage measurement delivered at the converter output is visible on the touch screen.

### Operation

Power supply for the AC electric sockets 220 V in the cabins:

Once there is sufficient nominal voltage coming from the AC switch panel, AC power is supplied by the socket onshore or by the generator.

If there is insufficient nominal voltage coming from the AC switch panel, the AC power supply automatically switches over to the inverter. In this way, the power for the 220 V sockets in the cabins can be supplied by the inverter, itself being supplied by the service battery bank. Be careful to disconnect the inverter circuit, to prevent the AC power supply automatic switching over and to prevent the accidental discharge of the service battery bank:

- either by putting the inverter's circuit-breaker in the OFF position,
- or by putting the switch located on the inverter in the OFF position.

**Simply cutting the AC power supply at the switch panel does not cut the AC power supply to the cabins: it is also necessary to disconnect the DC supply.**

### Operation

- The inverter is fully automatic.
- A remote control is located near the boat's switch panel. To start the converter put the switch on the inverter in the "REMOTE" position then put the switch located on the remote control in the "ON" position.
- If the switch on the inverter is in the "OFF" position, you cannot use the remote control to start it.
- The DC / AC converter operates by default when the shore power supply is not powered. It is controlled by a relay connected to the shore connection. This converter powers the indoor sockets and some on board appliances.
- When the shore connection is not connected, the relay automatically connects the inverter on a part of the on board AC circuit.
- When the shore power socket is plugged in and powered, the relay automatically disconnects the inverter.

## Maintenance

- Check at least once a year that the inverter cables and connections are properly bundled.
- Clean the inverter by removing any accumulated dust to ensure good ventilation.

### Inverter

Converter circuit breaker  
Location: Port aft cabin



The control located on the equipment



Remote control  
Location: Chart table



Refer to the manufacturer's instructions for use and maintenance.

**NEVER:**



- connect the inverter AC lead to an AC terminal or to the generator onboard.
- disconnect the wiring from the inverter when in use.
- open the inverter.

## 8.4.6 AC breakers

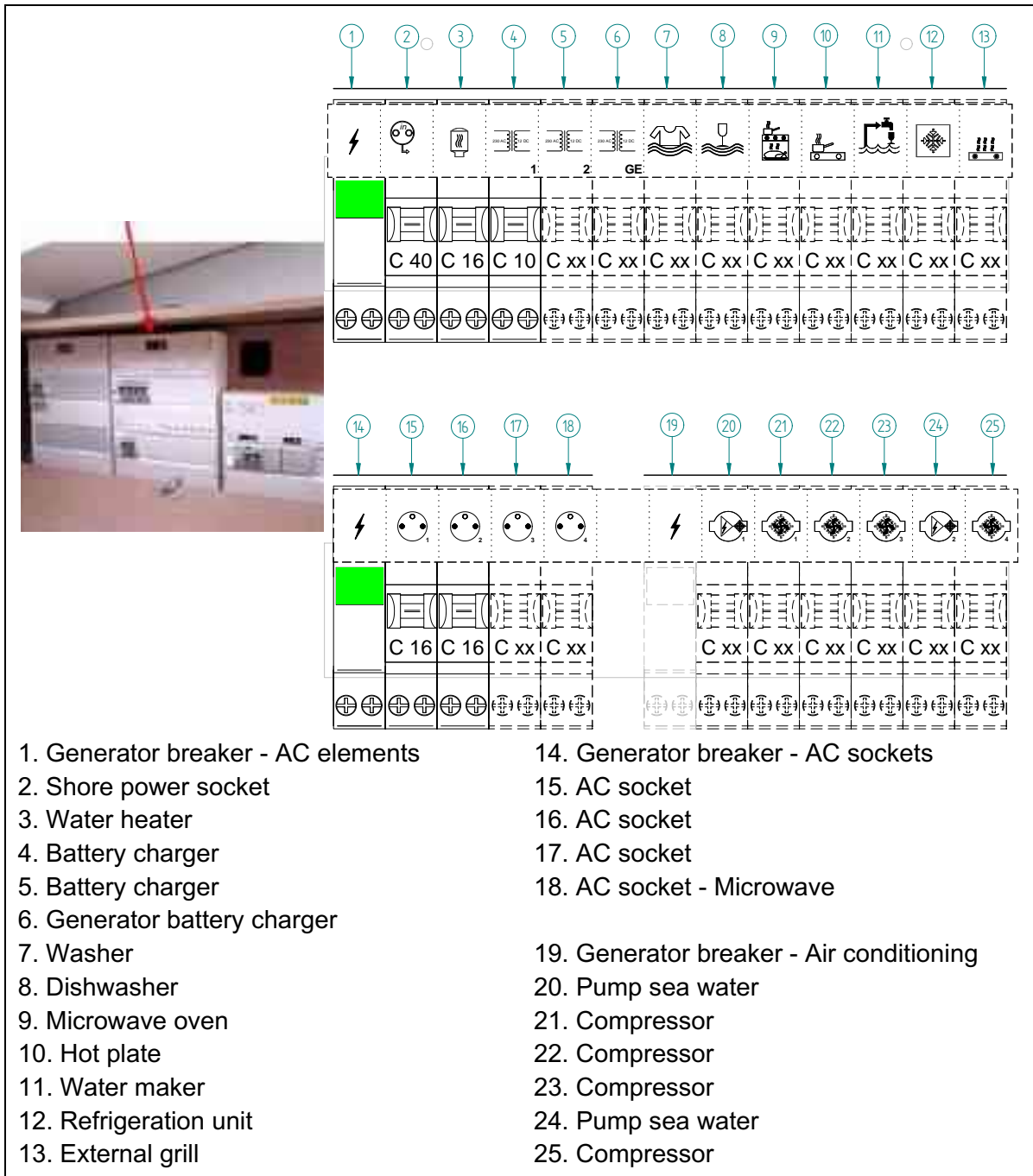

### 8.4.7 Installation of hull wiring harnesses - AC circuit

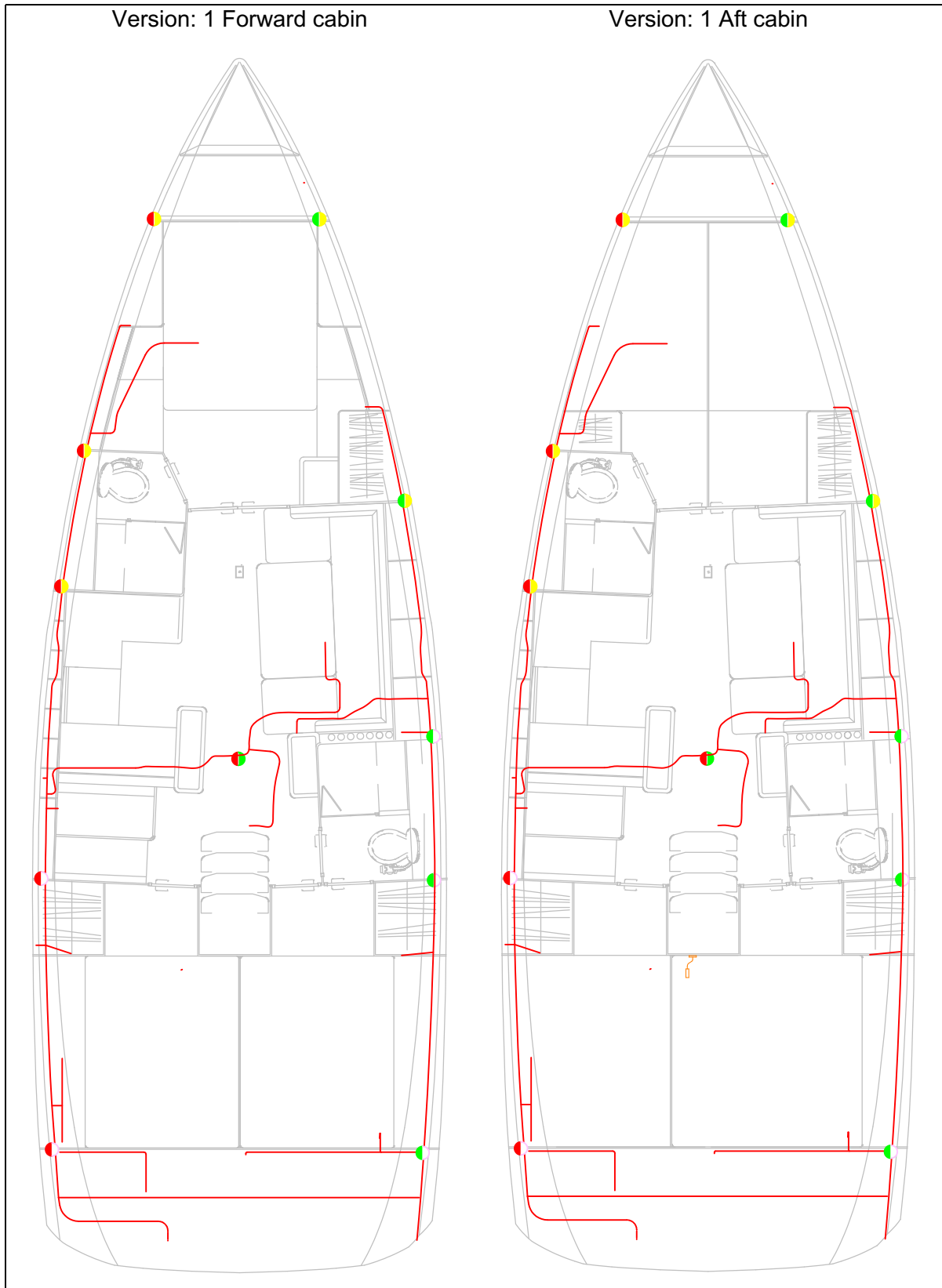

---

## 8.5 PROTECTION AGAINST ELECTROLYSIS / EARTH PLATE

### 8.5.1 Anodes

#### General points

- The sacrificial anode protects the submerged elements of the boat against electrolysis.
- A sacrificial anode is a consumable part that protects submerged metal parts by its dissolution (oxidation). The anodes used are made of a metal that is more readily reductive than the metal they are protecting.
- On a new boat, all the underwater metallic components try to be at the same electric potential, which leads to the rapid deterioration of the anodes in the first few weeks in the water.
- You can put several anodes on the hull.

#### Maintenance

- At least 2 times a year, check the corrosion on all of the anodes. Change the anode if necessary (Before it lost 50% of its weight).
- Use the appropriate anodes for the cruising area: fresh water/magnesium anodes; Sea water/zinc anodes.
- If the motor mountings are raised, the anodes are out of the water: in this case the anodes can no longer protect the sterndrive: take note of the skipper's recommendations.
- When the boat is kept in a dry dock, a light deposit of dust will settle on the anodes: Before returning the boat into the water, clean the anodes.

#### Cleaning anodes

- Use sandpaper. Do not use metal brushes or steel tools to clean the boat, it may damage the galvanic protection.



## Replacing the anodes

- The anodes are fastened with screws and nuts. First, remove the screws and nuts that hold the anode, then clean the contact surface. Press the new anode to obtain a good electrical contact.
- Change all the anodes every year.

Propeller anode



Bow propeller anode



- Never cover the anodes in antifoul.
- During the first few weeks that the boat is in the water, check the anodes and if necessary replace them: they erode very rapidly during this period.

---

## 8.5.2 Earthing plates

- An earthing plate is a shot-peened plate mounted on the hull to recreate an earth neutral point on the electrical circuit of the equipment supplying AC power (generator and AC/DC convertor). The earthing plate earths this equipment.

**The earthing plate is not an anode: it must not be allowed to deteriorate.**

- If it deteriorates, consult a professional immediately to determine the cause. As the earthing plate is mounted across the hull below the waterline, if the earthing plate deteriorates the boat is at risk of sinking.

Outside view



Inside view



- Never antifoul over the earthing plates.



## 9 LIQUEFIED PETROLEUM GAS (LPG) SYSTEM

### 9.1 GENERAL POINTS

- The working pressure of the LPG unit is 28 millibars
- Recommended cylinder capacity:
  - Europe Version: 2,75 kg of butane.
  - US Version: 10 lb of propane.
- Have the hoses, the entire LPG system and the flue pipes in the LPG system inspected professionally and regularly (or at intervals determined by the national requirements of the country in which the boat sails), and have them replaced if damage is detected.
- Taps attached to empty cylinders must be closed and disconnected. Protective covers, lids or caps must be held in place. Spare bottles must be stored outside on the boat, protected from weather and mechanical damage. Any gas leaks must be only towards the outside of the boat.
- Do not impede access to the components of the LPG system.
- Do not use the housings or the LPG bottle lockers to store other equipment.
- Check the vent pipes at least once a year. Replace them if they have deteriorated or split.

**location of components**

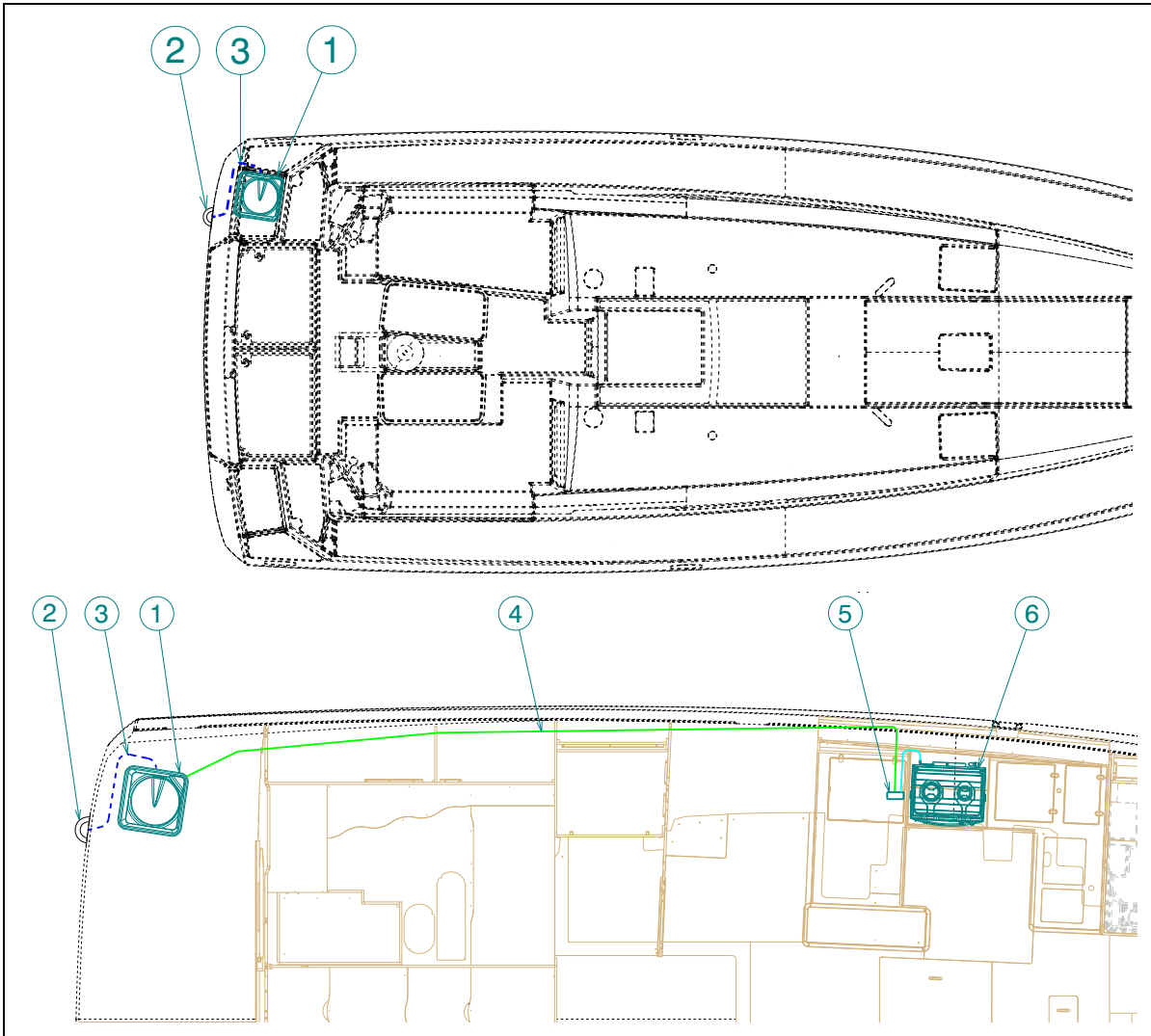

Reference	Designation
1	Gas cylinder locker
2	Kitchen sink evacuation through-hull
3	Gas locker drain
4	Gas system
5	Gas supply valve
6	Cooker

Europe Version

Gas cylinder locker



Hob / Oven



Gas supply valve



---

## US Version

Gas solenoid



Gas cylinder locker



### 9.2 OPERATION OF THE LPG SYSTEM

- Valves for supply lines and cylinder valves must be closed when appliances are not in use, before changing a cylinder and immediately in case of emergency.
- Appliance valves must be closed before opening the cylinder valve.
- It is necessary to ventilate when appliances that consume oxygen from inside the boat are used.
- If the stove is not suspended by gimbals, it should not be used when wide roll angles or continuous listing are likely.
- Please refer to the manufacturer's notes for the use and maintenance of the LPG cooker.



### 9.3 VERIFICATION OF THE LPG SYSTEM

The LP system should be tested for leakage before each use in any of the following ways:

- If the LPG circuit is equipped with a pressure gauge:

Before each use, close the appliance valve, open the LPG cylinder valve, allow the pressure gauge to stabilize, close the LPG cylinder valve, observe the pressure indicated by the pressure gauge near the LPG cylinder for 3 minutes. The pressure indicated by the manometer should be constant if there is no leak in the system.

The pressure indicated by the manometer should be constant if there is no leak in the system. If bubbles are observed in the detector liquid, there is a leak.

**NOTE: the pressure gauge gives no indication of the amount of LPG remaining in the cylinder, but only its vapour pressure, which is a constant at a given temperature.**

- If the LPG circuit is equipped with a bubble leak detector, use it as follows:

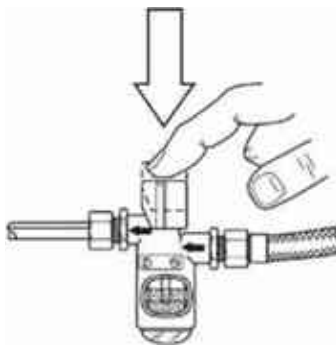

Regularly observe the bubble leak detector.

OR

Once the installation is under pressure and stabilised, press the detector push button. The installation is not leaking if bubbles do not appear in the detector liquid. If bubbles are observed in the detector liquid, there is a leak.

- Carry out a manual search by applying a foaming solution, or soapy water or a detergent (with the taps of the burners closed and those of the installation and of the gas bottle staying open). The foaming solutions for detecting leaks in the gas installations conforming to the EN 14291 meet these requirements.

- If an LPG leak is detected or suspected, immediately take the following measures:

- Do not use LPG appliances;
- Disconnect the LPG supply from the supply valve(s);
- Extinguish all naked flames and other sources of ignition (heaters, cooking appliances, pilot lights, etc...);
- Do not operate electrical switches;
- Evacuate the area if possible.

**NOTE: The leak tests carried out by the boat user do not replace a regular and complete checking of the LPG circuit by a competent professional.**



- When the cooker is on, ventilate well to prevent any risk of asphyxiation.
- Do not use the cooker as a means of heating.



- If a leak or fire from an LPG tank is detected, close the main LPG supply valve and do not use LPG appliances.
- Do not use an installation with a leak before it has been inspected and repaired by a competent person.
- Do not modify the boat's LPG system. The installation, modification and maintenance should be carried out by a competent person. Have the system checked at regular intervals or as fixed by national requirements.
- Never use a naked flame to check for leaks.
- Do not use a hotplate or an oven to heat the living areas.
- Equipment with a naked flame burning fuel consumes the oxygen in the cabin and gives out combustion residue in the boat. Ventilation is necessary when this equipment is used. Open the vents provided for this when using this equipment. Do not use a hotplate or an oven to heat the living areas. Never obstruct the vents provided for ventilation.
- Ventilation requirements have been calculated for LPG appliances as installed. Additional ventilation openings may be required if other appliances are installed simultaneously (please consult a professional).
- Never leave the boat unsupervised when equipment using LPG with a naked flame is on.
- Do not smoke or use a naked flame when replacing LPG bottles. Close the tap on the empty bottle before detaching it to replace it.
- To ensure sufficient ventilation, make sure that you open the hatches or ports near the hotplate when using it



- Do not use solutions containing ammonium when testing for leaks manually (ammonia, which is present in certain soaps and detergents, attacks brass connections. Although the damage may at first be impossible to detect, the cracks and leaks may appear several months after the contact with the ammonia)).

### To change an LPG bottle

1. Close the tap on the LPG bottle
2. Detach the LPG bottle
3. Replace the LPG bottle
4. Attach the new LPG bottle
5. Open the tap on the LPG bottle





## 9.4 LAYOUT DIAGRAM

Europe Version

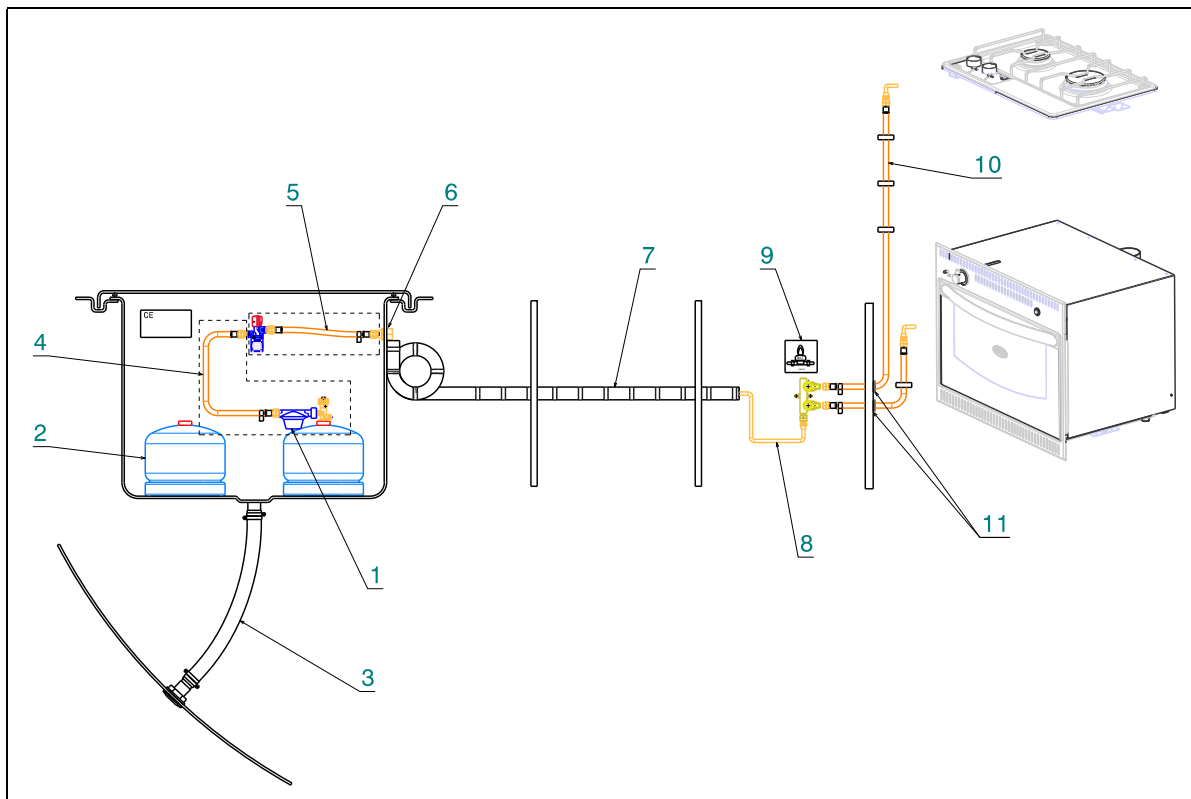

LIQUEFIED PETROLEUM GAS (LPG) SYSTEM

Reference	Designation
1	Regulator valve
2	Gas cylinder
3	Drain
4	Gas bottle connection kit
5	Bubble tester kit
6	Rubber washers
7	PVC girdled sleeve
8	Copper gas connection kit
9	Label
10	Gas appliance connection kit
11	Thru-wall fitting

US Version

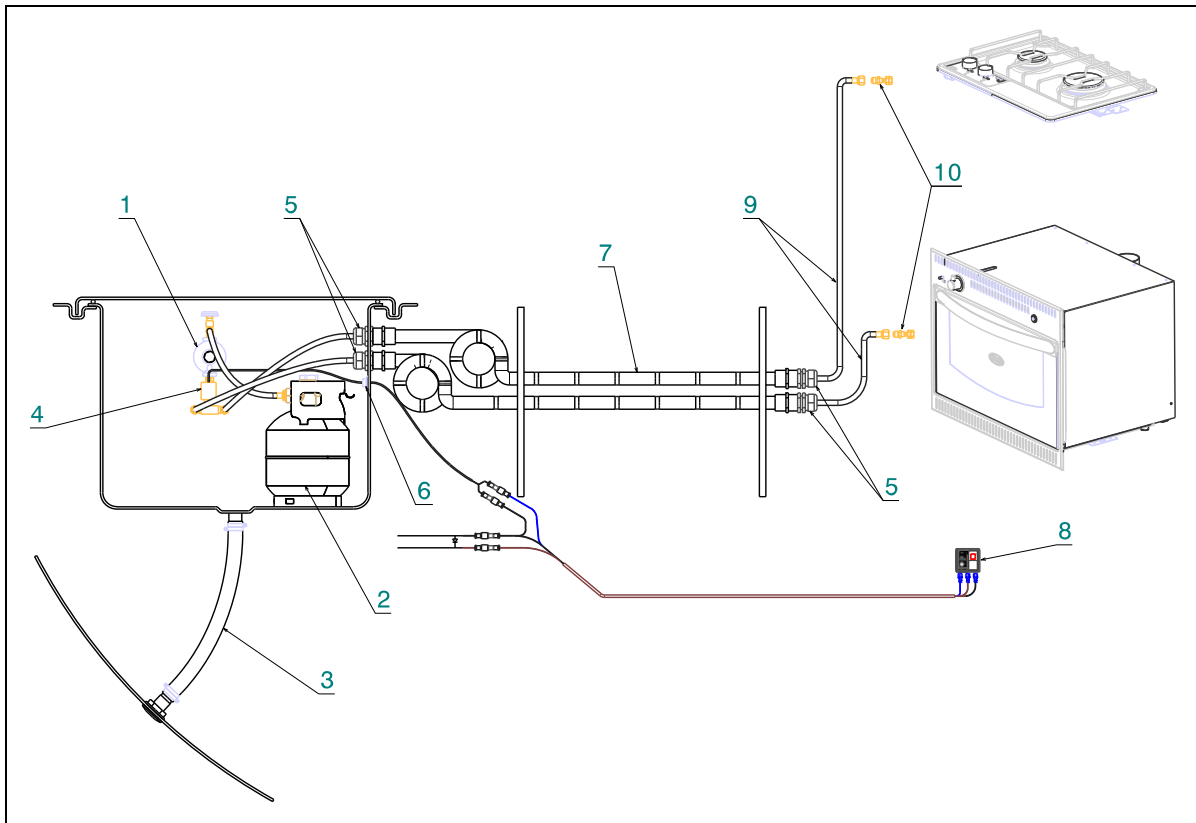

Reference	Designation
1	Regulator valve
2	Gas cylinder
3	Drain
4	Electromagnetic valve (12 V)
5	Thru-wall fitting
6	Wire passage
7	PVC girdled sleeve
8	Solenoid switch
9	Plastic propane pipe
10	Gas appliance connection kit



## 10 DOMESTIC APPLIANCES

### 10.1 FRIDGE / COOLER

#### General points

- The fridge is composed of 3 components: the compressor, the evaporator and the condenser. These components are connected by a closed circuit refrigerant gas circuit. The fridge is air-cooled.
- The fridge is DC powered. It is designed to chill food and drink. Any other use is dangerous and forbidden.
- A breaker protects the electrical circuit.
- The icebox without an evaporator keeps the food and drink chilled.
- The ON/OFF start button is located on the fridge.
- The thermostat is in the inside compartment of the fridge. It enables the selection of the desired temperature setting for the inside of the fridge.
- The refrigeration power can be affected by:
  - The ambient temperature,
  - The quantity of food to chill,
  - The frequency of opening the door.

#### Maintenance

- Clean the evaporator with a damp cloth at least once a year. Never use cleaners which are abrasive, acid or which contain solvents for cleaning the evaporator.
- Regularly clean the fridge/icebox door seal with a damp cloth.
- Regularly defrost the fridge.
- When winterising the boat, leave the fridge door/icebox cover open to prevent mould and smells from developing.

#### **ADVICE-RECOMMENDATION**

- Refer to the manufacturer's instructions for use and maintenance.
- Never heat or use tools to defrost the inside of the fridge more quickly (risk of damaging the interior surface).
- Never obstruct the heat exchanger of the fridge.

Fridge (Positive temperature)  
Location: Galley



Additional fridge



Refrigeration unit  
Location: Under the sink



Fridge (Negative temperature)  
Location: Port aft cabin



Cockpit fridge (Positive temperature)

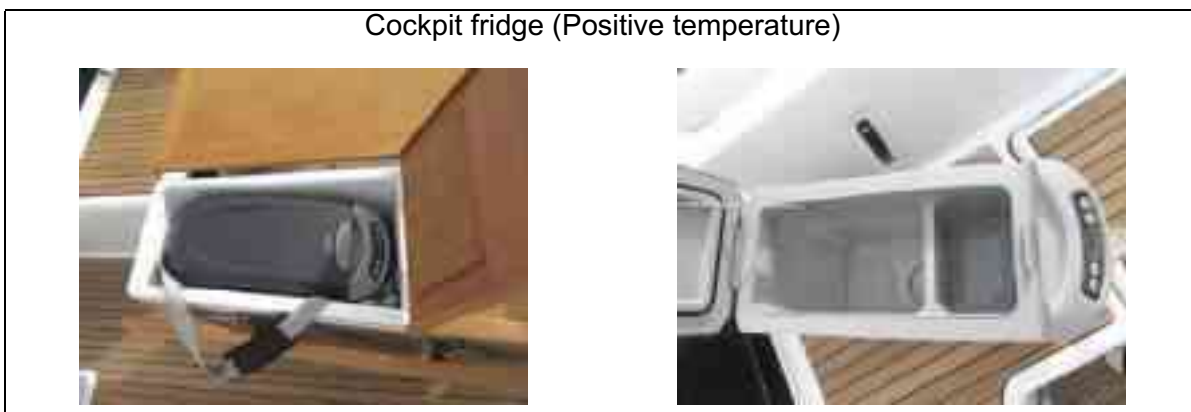

Operation:

- It is necessary to fasten the portable refrigerator securely inside the boat using the supplied straps.
- Place the refrigerator on a dry and protected surface. Avoid placing it outdoors or exposed to the weather.
- The portable refrigerator is equipped with a DC power cable with plug to connect into one of the boat's 12V sockets.

Connection to DC 12V socket

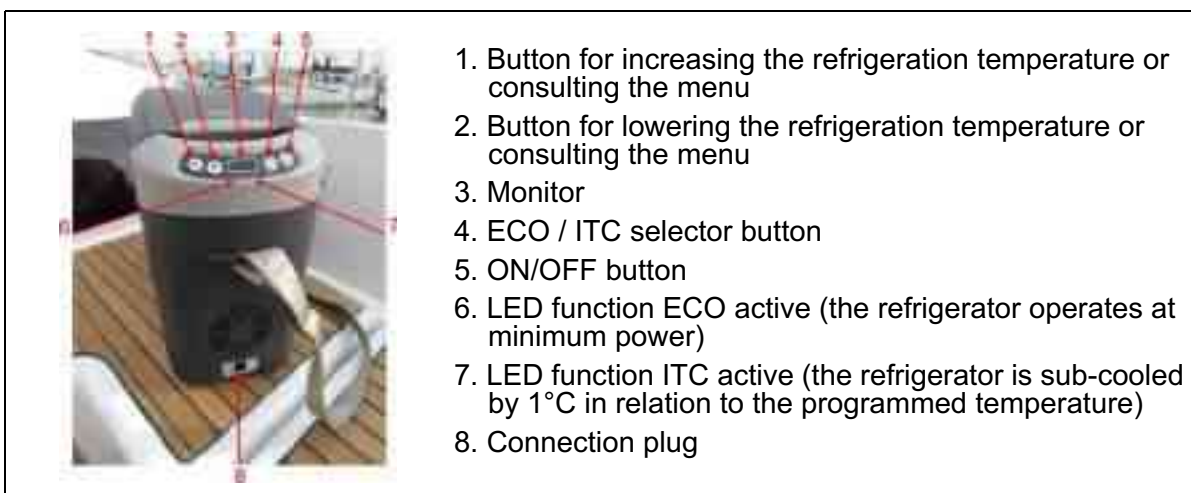

1. Button for increasing the refrigeration temperature or consulting the menu
2. Button for lowering the refrigeration temperature or consulting the menu
3. Monitor
4. ECO / ITC selector button
5. ON/OFF button
6. LED function ECO active (the refrigerator operates at minimum power)
7. LED function ITC active (the refrigerator is sub-cooled by 1°C in relation to the programmed temperature)
8. Connection plug

---

## 10.2 MICROWAVE

### General points

- The microwave is AC powered.
- A breaker protects the electrical circuit.
- The microwave is designed to reheat food and drink or to cook food. Any other use is dangerous and forbidden.
- The microwave must never be started when empty.
- Remove all foil or metallic elements of the packaging before putting food in the microwave.
- Remove hermetic coverings from the packaging before putting food in the microwave.

### Starting up

- On the switch select the chosen source of current (shore power or generator).
- Put the microwave circuit-breaker in the ON position.

### Maintenance

- Regularly check the door seals.
- Regularly clean the inside of the fridge with a damp sponge.



- To remove the microwave from its storage, press downwards : the microwave and its support will come out upwards.
- To put the microwave away, press it downwards until it "clicks" : the unit is then stowed and locked.

***NOTE: do not use the microwave when it is in stowed position.***



### 10.3 WASHER

#### General points

- The washing machine runs on an AC power supply.
- A breaker protects the electrical circuit.
- The washing machine is supplied with water from the onboard tanks via a supply valve.
- Dirty water is drained to the grey water tank/by draining the sink.

#### Starting up

- Check the level in the water tanks and switch on the water system.
- Open the water supply valve/washing machine.
- Turn on the AC circuit (shore or generator) and actuate the washing machine circuit breaker.
- Start the washing machine.



- Refer to the manufacturer's instructions for use and maintenance.
- Do not operate the washing machine/dishwasher when at sea.

---

Washer



Filter (Access): directly on the device



Drainage  
Location: Left side



Fresh water socket  
Location: Under the sink







## 10.4 BARBECUE (transportable outdoor cooker)

### General points

- The compact barbecue is a transportable cooker that uses briquettes as fuel.
- The hob has two sides, a ribbed one to grill like a traditional barbecue, and a smooth one to cook like with a frying pan.
- When the lid is closed, the barbecue functions like a traditional oven for cooking food.

### Lighting instructions with charcoal briquettes

- The barbecue is designed to be used only on its support (cockpit table handrail) when the boat is not under way.
- Open the barbecue and remove the plate.
- Provide for 1 or 2 fire lighters in the firebox.
- Stack 8 to 10 briquettes (about 300g).
- Light the fire lighters, and let the briquettes burn for about 20 minutes.
- When the briquettes are grey, the barbecue is ready to be used.
- Put the plate or grill in the barbecue, which will heat for about 2 hours.
- Watch the barbecue all the time of cooking.

### **NOTE:**

- **Once cooking is done, remove the lid and the plate and allow the briquettes to burn away (never let the hot briquettes burn in the barbecue with the plate and lid, without food).**
- **After complete cooling, the barbecue must be stored in the proper place (see plan).**

### Maintenance

- All surfaces should be cleaned by hand with a warm soapy solution, applied with a soft sponge.
- All parts of the barbecue are dishwasher safe.



- The barbecue in use will become very hot : do not touch it or move it during use.
- Do not use the barbecue in an enclosed area.
- Do not use alcohol, petrol or similar products to light or reactivate the barbecue.
- Do not let a child use the barbecue.

Storage bag



Barbecue (General view)



Plate / grill



Fuel



Diagram of the layout

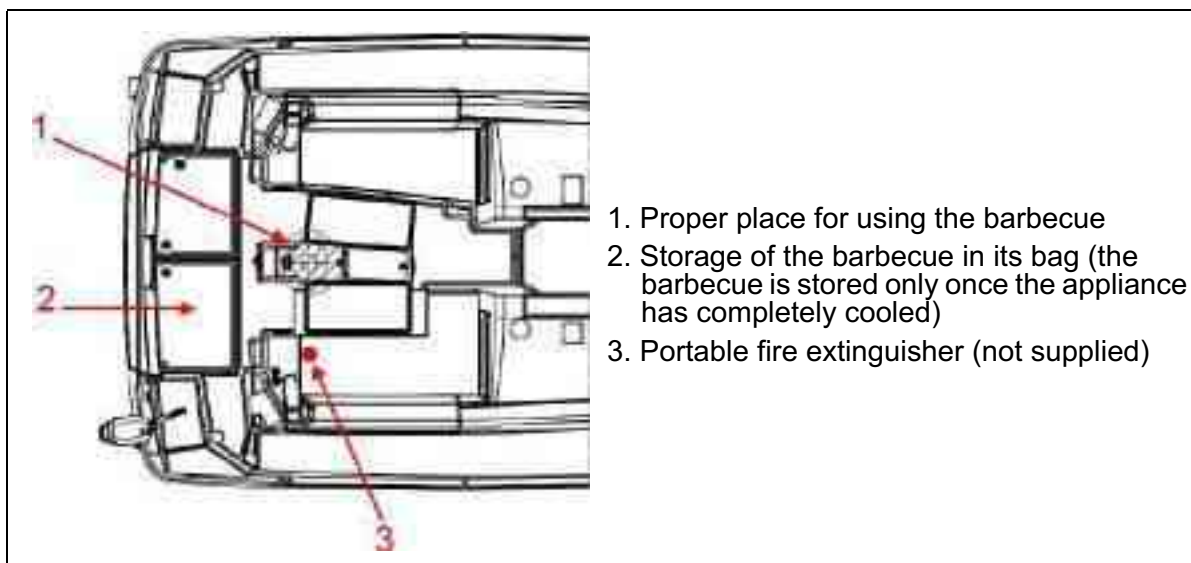





## 11 AUDIO-VISUAL EQUIPMENT

### 11.1 TELEVISION

#### General points

- The television supply operates on alternating current. Depending on the equipment of the boat, alternating current may be provided by:
  - the AC shore power socket,
  - the generator,
  - the DC / AC converter powered by service batteries.
- A circuit-breaker protects the circuit.
- Pre-cabling for the aerial is already installed on the boat.

#### Starting up

- First turn on the circuit breaker, then switch on the TV.

#### Mechanism for raising/lowering the TV

- The equipment can be activated while underway.

	<ul style="list-style-type: none"><li>- The stowage unit opening and closing mechanism motor is very powerful. Please do not obstruct the movement of the TV, especially when stowing it in its compartment. Beware of the risk of trapping a part of your body, especially the hands.</li><li>- Keep children away when handling mechanisms.</li></ul>
--	---

---

## 11.2 HIFI

- The sound system is DC powered.
- The sound from the TV or from the DVD player is amplified by the boom box and the speakers.
- The sound from the TV comes out of the integral speakers.
- The sound from the TV can come from the speakers if AUX is selected on the DVD player.
- The sound from the DVD player comes from the speakers.
- The sound from the radio comes from the inside and outside speakers. It is possible to select either outside or inside speakers by adjusting the balance control.

Interior and exterior speakers



Base box (Bass speaker)  
Location: Starboard saloon



### ADVICE-RECOMMENDATION

Refer to the manufacturer's instructions for use and maintenance.



## 12 ONBOARD COMFORT

### 12.1 AIR CONDITIONING

#### General points

- The air-conditioning is powered by alternating current.
- The air-conditioning cools the air temperature inside the boat (only when the boat is floating in water).
- The cooling circuit consists of one or more compressors that operate independently. A compressor is called "reversible" because it can heat the boat if the sea water temperature exceeds 13°C.
- In winter, you can programme the dehumidifier function on the airconditioning controls.
- The refrigeration compressors are made by one or two seawater pumps. These pumps are run on AC voltage and are master controlled by one or two can relays.
- Sea water is evacuated through a through-hull fitting equipped with a valve, located above the waterline. Each compressor has its own through-hull evacuation fitting. It is advisable to check the flow of water visually once the air conditioning starts running.

#### Operation

Before starting the engine:

- Open the raw water intake valves and evacuation valves;
- Make sure that the control panel is in the STOP position;
- Use the switch on the chart table to select the power source (shore power or generator).
  - If using shore power: plug into the shore power socket;
  - If using the generator: before turning on the air conditioning, leave the generator running for about 3 minutes.
- If the seawater pump is deprived (eg. in case of running aground), follow the following procedure:
  - Disconnect the discharge hose from the seawater pump by loosening the 2 stainless steel collars;
  - Blow air through the pipe using a compressor;
  - Re-connect the discharge hose with 2 stainless steel collars.

---

The air conditioning is running:

- Switch the air-conditioning circuit-breakers ON.
- Select the temperature of each compressor using the control units.

- Refer to the manufacturer's instructions for use and maintenance.
- When the air-conditioning is running, check visually that the sea water has been fully drained.
- Never start the generator when the climate function is already on.
- Always turn off the air conditioning before turning off the generator.
- Regularly check and clean the sea water filter placed on the sea water intake through-hull fitting.



- Close the sea water intake valve;
- Unscrew the top of the filter;
- Clean the strainer;
- Put everything back in place.
- Clean the air filter (located in the compressor) regularly for maximum performance of the installation.
- Clean the cooling coil at least once a year.
- To prevent the air-conditioning circuit from freezing: never run the system when the seawater temperature drops below 5 degrees C.
- Winter Storage: drain the whole sea water system.
- The cooling gas circuit needs no maintenance.

### Layout of components

Compressor positions





Location: Companionway



1. Sea water intake
2. Sea water filter

Drainage of condensation and sea water



from left to right:

- Condensation drain - Forward cabin
- Condensation drain - Saloon
- Condensation drain - Aft cabin
- Condensation drain - Forward cabin
- Condensation drain - Saloon



Seawater discharge (Aft cabin)

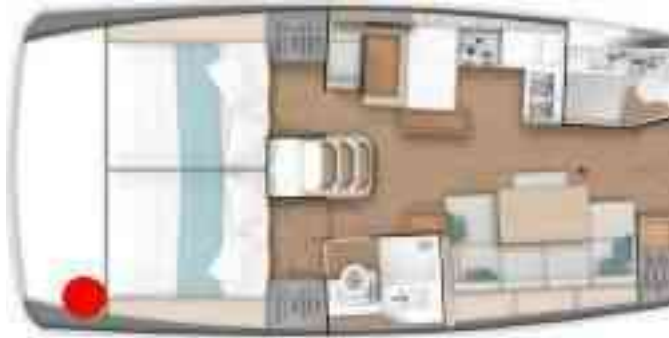

Location: Galley floor  
Pump sea water



Air-conditioning controls

*Please refer to the key on the following page*

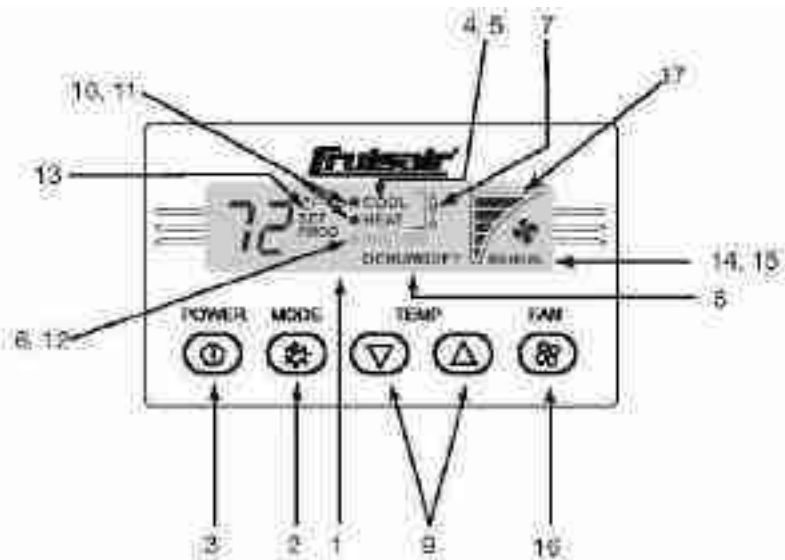



## Manual control of the air-conditioning

1. Data display:  
Screen which displays the desired temperature, the programmed values and the error messages.
2. MODE:  
Enables you to navigate between the different operating modes.
3. POWER/OFF:  
Comes on when the system is switched off. The manual ventilator may continue to run.
4. COOL:  
Indicates that the compressor is activated when cooling.
5. HEAT:  
Indicates that the compressor is activated when heating.
6. Option (Auxiliary heating).
7. AUTOMATIC:  
Comes on when the system is in AUTO mode.
8. DEHUMIDIFY:  
Comes on when the system is in dehumidifying mode.
9. Keys + and -:  
Allow you to raise or lower the desired temperature.
10. Cooling indicator:  
This indicates that the compressor is in COOLING mode.
11. Heating indicator:  
This indicates that the compressor is in HEATING mode.
12. Option (Auxiliary heating).
13. temperature control indicator:  
This indicates the temperature control adjustment (the desired ambient temperature).
14. Indicator for the manual ventilator:  
This comes on when the manual ventilator is running.
15. Indicator for the automatic ventilator:  
This comes on when the ventilator is running in automatic mode.
16. Ventilator key:  
Allows you to select manual or automatic mode for the ventilator.
17. Ventilator speed indicator:  
Shows the ventilator speed.

---

## NOTES

- When the system is programmed in dehumidifying mode, the system's safety devices remain active: if there is an interruption in the flow of sea water or a drop in AC voltage, the system automatically stops.
- In cooling mode, the system works efficiently when the sea water temperature is below 30 degree C.
- In heating mode, the system works efficiently when the sea water temperature is above 13 degree C.
- It is important to switch the system to HEATING mode at least once a month, to prevent the crossover cock becoming stuck in COOLING mode.

## LOCKING METHOD

It is possible to lock the control buttons to avoid any accidental handling: Press the three buttons at once: MODE, UP (arrow pointing up), FAN.  
LC appears on the screen, which signifies "LOCK".

To unlock and resume use of the buttons, press the three buttons at the same time: MODE, UP (arrow pointing up), FAN.  
UL appears on the screen, which signifies "UNLOCK".

## SCREEN LIGHTING

If the control box is switched off by a fault (in the cabins for example), just touching a button automatically lights up the screen in a blue colour instantly.

To alter the light intensity of the screen, press the two buttons simultaneously: MODE, UP (arrow pointing up) until the required intensity is reached.

It is possible to programme whether or not a box is illuminated by default: In this case mode ON must be selected for a permanently illuminated box or mode SLEEP for a permanently unilluminated box.

Procedure:

- Simultaneously press the 2 buttons: MODE and DOWN (arrow pointing down).
- With the arrows select n°18 on the menu, then confirm by pressing MODE.
- With the arrows select either ON for illumination by default or SL (SLEEP) to turn the box off.
- The press 2 times on FAN to confirm the selection.

**Diagrammatic view - Air conditioning**

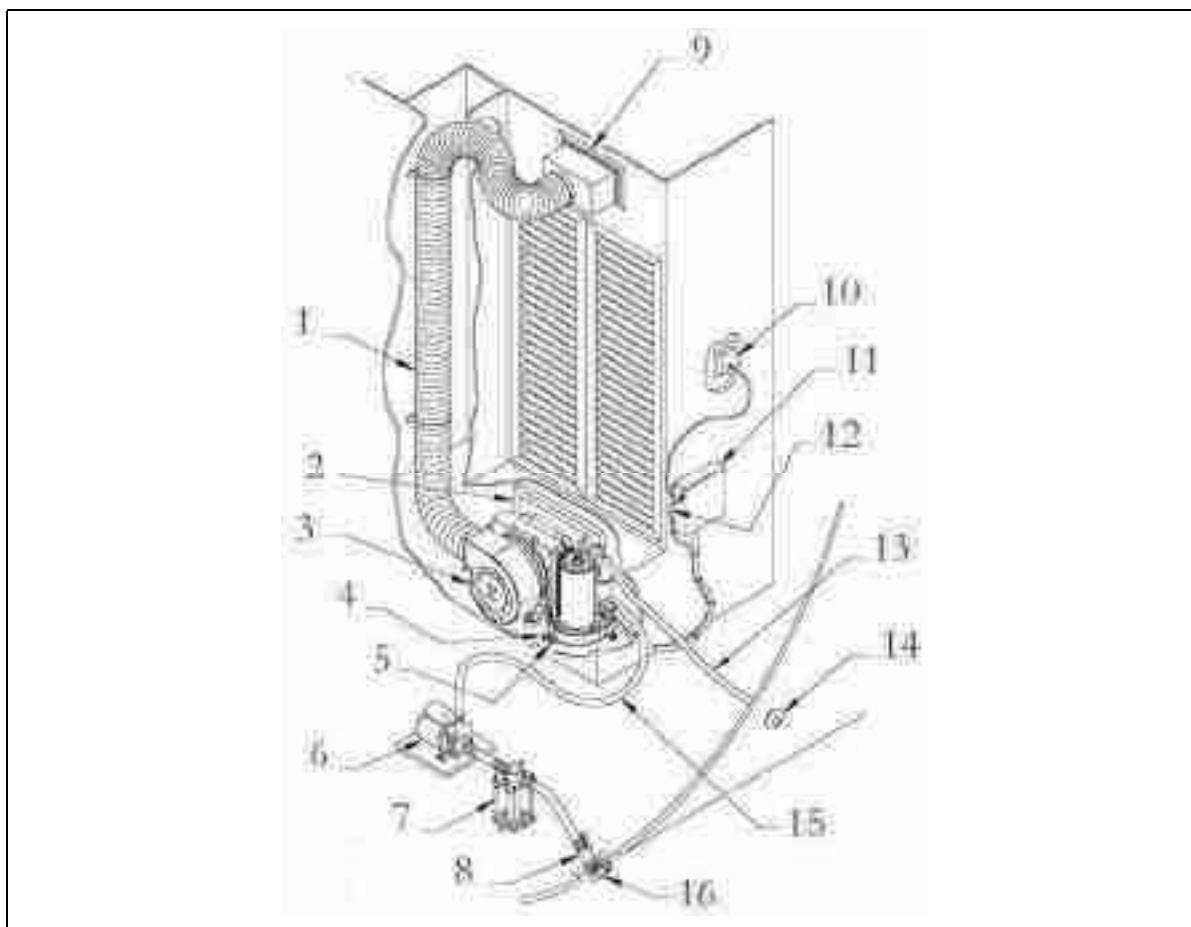

Reference	Designation
1	Insulated pipe
2	Ambiant air intake
3	Refrigeration unit
4	Mounting support
5	Condensation water pipe
6	Seawater pump
7	Filter
8	Seawater supply valve
9	Conditioned air outlet
10	Manual control
11	Relay box
12	Temperature sensor
13	Sea water drain pipe
14	Thru-hull fitting
15	Sea water supply
16	Sea water strainer

---

## 12.2 ELECTRONIC EQUIPMENT

The onboard electronics are powered by direct current.

### Lead lines



- Do not store material on top of the sensors.
- Do not cover the sensors in antifoul when antifouling the hull.
- Regularly clean the sensors.

### Auto pilot

- To ensure optimum performance, keep all metallic objects away from the gyrocompass.
- Do not store material close to the calculator and electrical connections.

Layout of components:

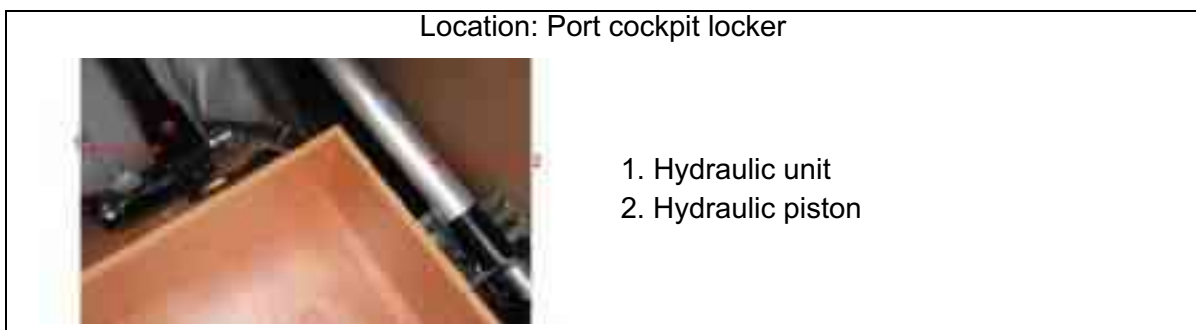
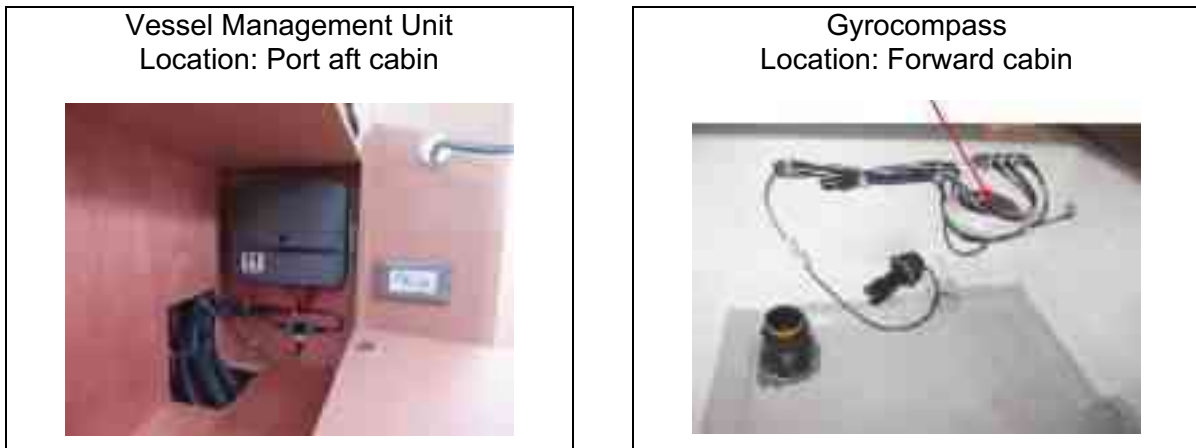

VHF

Layout of components: Chart table



Aerial (AIS)  
Location: Port cockpit locker



ONBOARD COMFORT

AIS



**ADVICE-RECOMMENDATION**

- Place the protective covers on the repeaters when unused for long periods.
- When sailing store the protective covers inside the boat to avoid losing them.
- The various repeater displays are back-lit.
- Regularly clean the fascias of the repeaters with fresh water.
- Refer to the manufacturer's instructions for use and maintenance.

---

## **12.3 EQUIPMENT OTHER THAN FOR PROPULSION, WHICH BURNS FUEL (GENERATOR, HEATING)**

### **12.3.1 General points**

- Make sure that the ventilation openings in the engine (and generator, if installed) compartment are well cleared.
- Stop the engine and refrain from smoking during fuel tank filling.
- Get your fuel circuit checked regularly by a professional engineer.
- Avoid any contact between inflammable materials and the hot sections of the engine.
- Take all necessary precautions to avoid contact with naked flames and other hot areas.
- Do not obstruct or modify the ventilation system.
- Fuel stored outside the tanks (jerrycans, portable fuel tanks, etc.) must be stowed on deck, protected from bad weather and mechanical damage.



### 12.3.2 Generator

Layout diagram

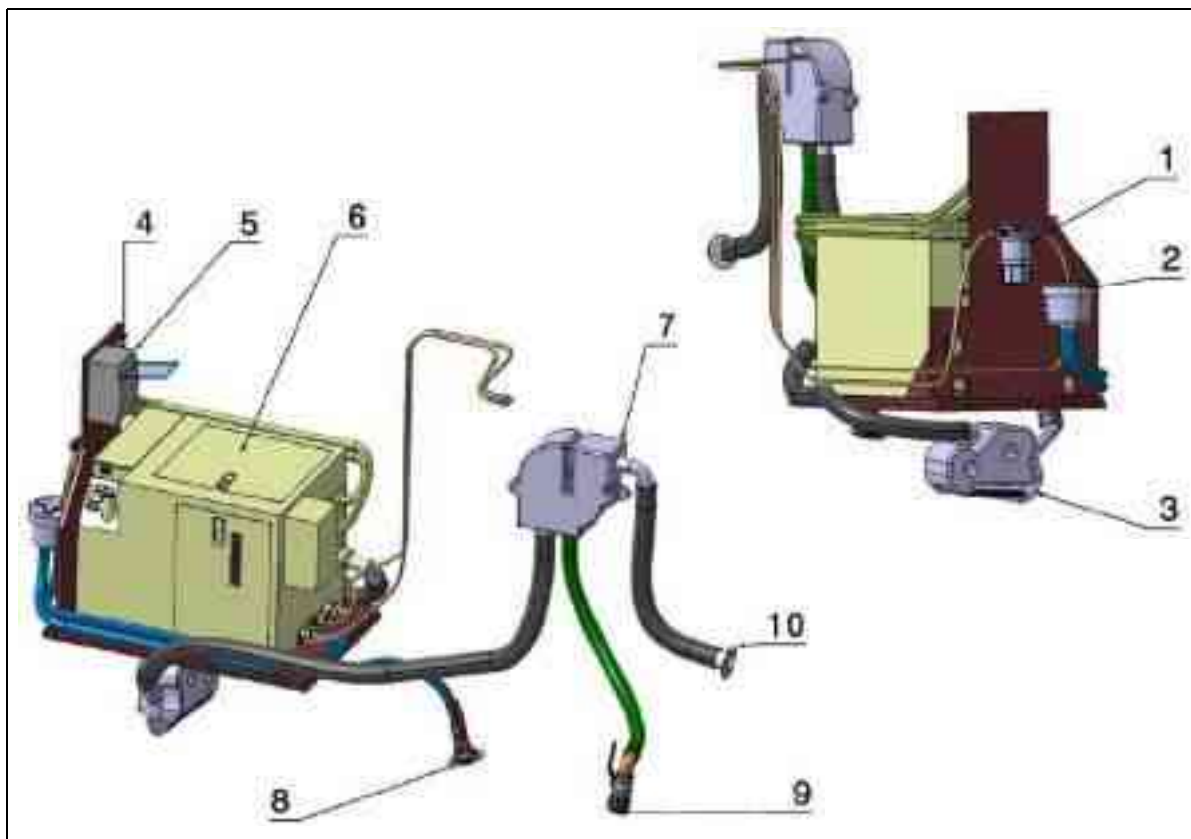

ONBOARD COMFORT

Reference	Designation
1	Fuel filter
2	Sea water filter
3	Water trap
4	Anti-siphon valve
5	Differential circuit breaker
6	Generator
7	Water - Gas separator
8	Seawater inlet
9	Seawater discharge
10	Outlet

---

## General points

- The generator is a machine which can produce AC electrical power using mechanical power (fuel). The generator will feed the onboard equipment operating at 220V or 110V, moored or sailing.
- The generator starts with its own battery (12 V circuit).
- Make sure that there is enough fuel in the fuel tank before using the generator. The generator is fed by fuel through the fuel tank port.
- The cooling water and exhaust gases are separated in the separator to avoid noise pollution. The seawater is discharged below the waterline. The exhaust- pipe is located above the waterline. Check visually that the exhaust gases are being expelled properly. Make sure that the ventilator in the generator compartment is working.
- Check to see if any leaks appear (sea water, coolant, fuel, exhaust gases). If there is a leak, stop the generator at once and get the leak repaired.
- The generator is earthed by an earthing plate which is located under the hull (see Chapter: EARTHING PLATES).
- Maintenance of the generator must only be done by qualified and proficient personnel. Before working on the generator, it is imperative to isolate the generator's battery power, to prevent it from starting accidentally.
- The generator can be started by the switch on the generator or by the switch on the control panel.

## Starting up

- Fill the generator with water to prevent the seawater pump from running dry (refer to the supplier's recommendations).
- Open the raw water intake valves and evacuation valves.
- Open the fuel supply valve.
- Turn the generator's battery switch to the ON position.
- Switch the generator's circuit-breaker to the ON position.
- Turn on the generator using the remote control (located near the main switch panel).  
or on the generator itself.
- Make sure that no AC equipment is running. Then set the shore power/ generator switch.

### In the event of the generator catching fire

- Don't open it.
- Cut the supply (electrical and fuel) to the boat's engines, to the generator and to the ventilators.
- Use the remote control lever of the fixed extinguisher.



- Please refer to the manufacturer's instructions for using the generator.
- Never start the generator when the climate function is already on. Always turn off the air conditioning before turning off the generator.
- Never connect the shore power to the generator: danger of electric shock.

### Layout of components

Location: Cockpit locker



1. Generator
2. Fuel filter
3. Expansion tank
4. Engine compartment ventilator



5. Fixed extinguisher remote control lever
6. Fixed extinguisher
7. ON / OFF control located under the appliance

Location: Port aft cabin

Fuel supply valve



8. Generator battery

9. Generator battery charger

Access: Starboard aft cabin



10. Water - Gas separator



11. Generator sea water drainage

Remote control  
Location: Touch screen



Generator seawater intake  
Location: Starboard saloon





### 12.3.3 Warm air heating system

#### General points

- The heating is powered by DC supply. The electrical supply is provided by the onboard battery bank.
- A fuse protects the circuit.
- You are advised to run the heating system for about 15 minutes every month (to prevent the operating components from becoming blocked/to refresh the fuel in the pipeline).
- The warm air heating system, installed at the back of the boat draws in the air outside via an integrated ventilator.
- The air warmed in the heating system is blown through the warm air ducts to the living area of the boat.
- The fuel is supplied via a feed pump by the fuel tank.
- The combustion system is separate from the heating system: The air intake for combustion is separate from the warm air heating system.
- The exhaust gases are expelled outside by an exhaust pipe with a silencer.
- The heating system compares the actual temperature with the desired temperature and automatically adjusts the heating power required.

#### Annual maintenance

- Clean or replace the fuel filter.
- Check that the heating ducts are in good condition.

---

## Layout of components

Heater  
Access: Cockpit locker



Sensor



Fuel pump



Fuel supply valve



Manual control  
Location: Starboard saloon

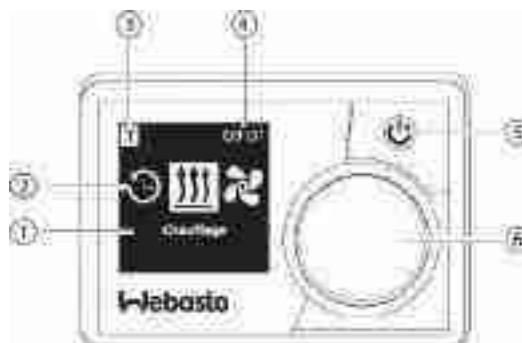

































1. Name of menu element
2. Menu symbol
3. Preset duration activated
4. Clock
5. ON / OFF control button
6. Control button (rotating and push button) to choose and confirm the desired function

The colour of the ON / OFF start button indicated the heating appliance status:

- continuous green: Heating
- continuous blue: Ventilation
- continuous white: Boiler off
- flashing red: Faults / no heating
- flashing green: Pre-programmed heating
- flashing blue: Pre-programmed ventilation

## Description of pictograms

	Timer menu		Ventilation menu
	Heating menu		Settings menu
	Normal heating mode		Eco heating mode
	Boost heating mode		Ventilation speed (speeds 1 to 4)
	Add the time programmer		Activate the time programmer
	Deactivate the time programmer		Delete the time programmer
	Delete all time programmers		Time programmer activated
	Instant starting		Day of the week
	Hour		Language
	Unit of temperature		Day / Night
	System information		Error information
	Reset (reset / return)		Repair - Please contact the repair and maintenance centre
	Left		Warning
	Return		Right
	12-hour display		OK
	Switched on		ADR



- Please refer to the manufacturer's instructions for the use and maintenance of the heating system.
- A sudden cut in the electrical supply risks damaging the heater:  
**REMEMBER TO SWITCH OFF THE HEATER BEFORE ISOLATING THE BATTERIES.**
- It is imperative to disconnect the electrical supply and to allow the hot components to cool before doing any maintenance or work on the heater.



Layout diagram

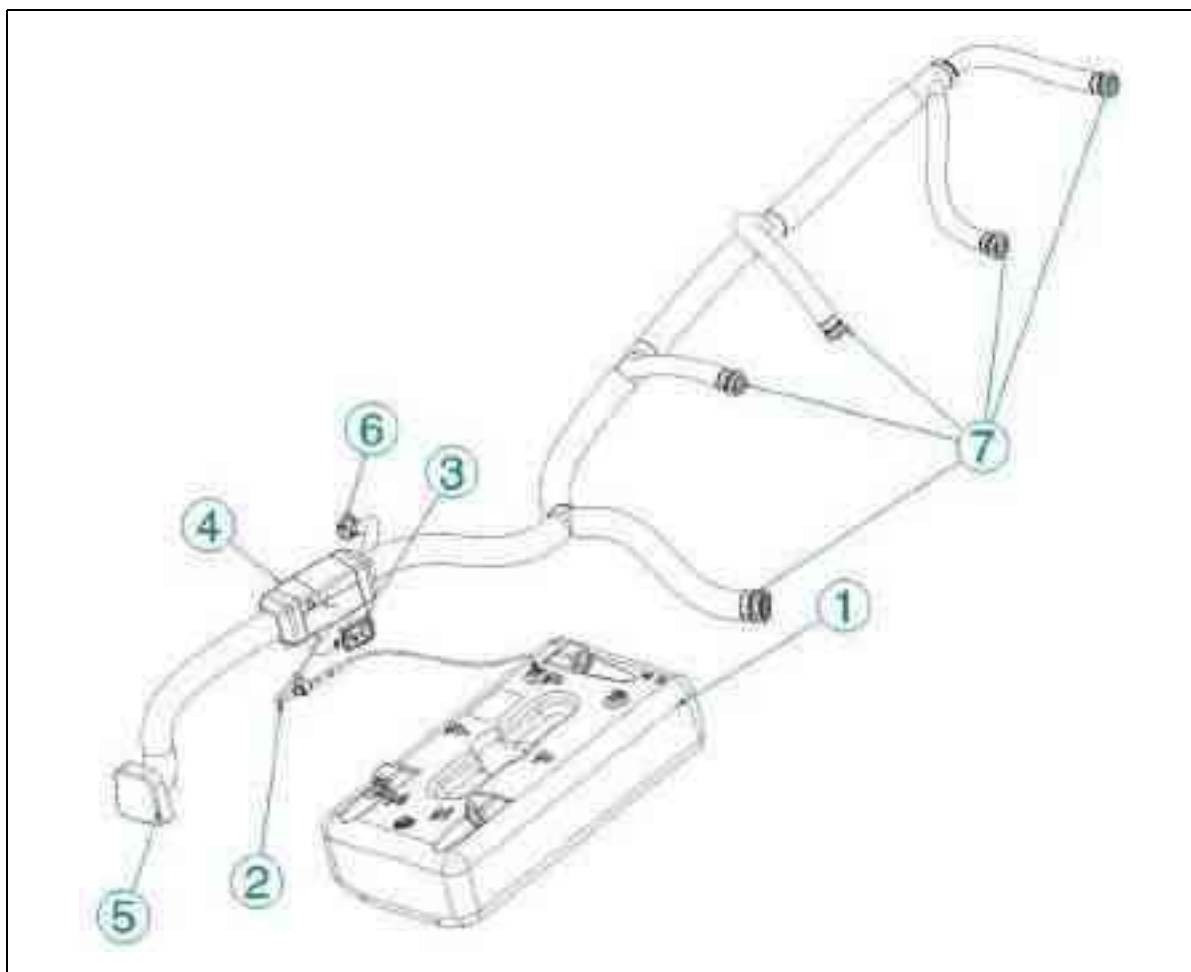

Reference	Designation
1	Diesel tank
2	Metering pump
3	Control box
4	Heater
5	Fresh air intake
6	Heating exhaust
7	Hot air openings



- The heater must be switched off when refilling the fuel tank.
- The heater's exhaust gases are very hot: they risk burning the shock mounts or the cables running too close to the exhaust outlet skin fitting.





## 13 WATER SYSTEMS

### 13.1 GENERAL POINTS

- It is essential to rinse the entire on-board water system the first time the boat is used (The water system is protected in the factory by a dietary anti-freeze).
- The water tanks may have had an anti-algae treatment using a copper sulphate based product. It is advisable to renew the treatment according to the area in which the boat is sailing.
- Drain all the water systems during winterisation (in particular the cockpit shower and water heater) to avoid damage from freezing.
- Clean/change the filters regularly.



- Regularly check water-tightness of joints in the water system installations. Check that screws and bolts are well tightened and replace them if they are worn or corroded.
- Disconnect shore water supply before leaving the boat (if fitted).
- If the boat is sailing in temperatures below freezing, it is possible to use anti-freeze in the water systems: use a non-toxic anti-freeze marked for dietary use.

**NEVER USE AUTOMOBILE ANTI-FREEZE: RISK OF POISONING.**

---

## 13.2 USING A VALVE

The valve is shut when the valve handle is at right angles to the pipe, the valve is open when the valve handle is in line with the pipe.

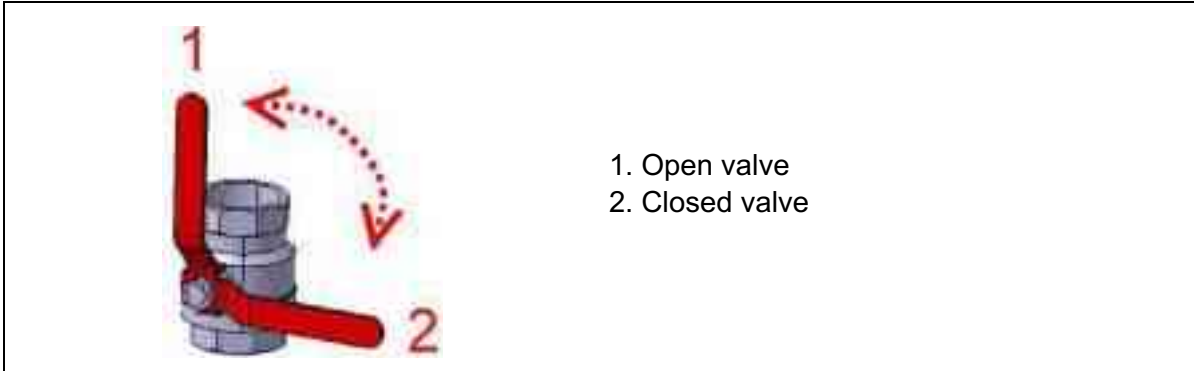

- Valves, through-hull inlets and other accessories in brass or bronze have a life of about 5 years. It is necessary to have a professional check on all valves, through-hull inlets and other accessories in brass or bronze edge every 5 years and replace them as necessary.

### Using the drainage valve

- The direct drainage to the sea valve can be plumbed by means of the drilled hole on the handle.
- Blockage of the drainage valve in closed position: Pass the tightening collar around the drainage valve and in the hole in the handle.

Plastic valve



Bronze valve



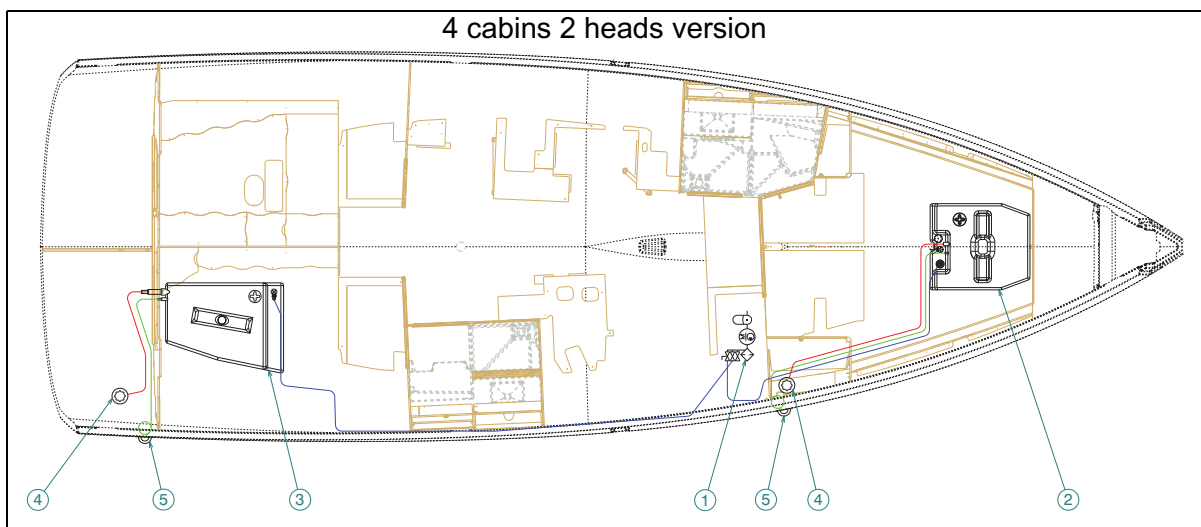
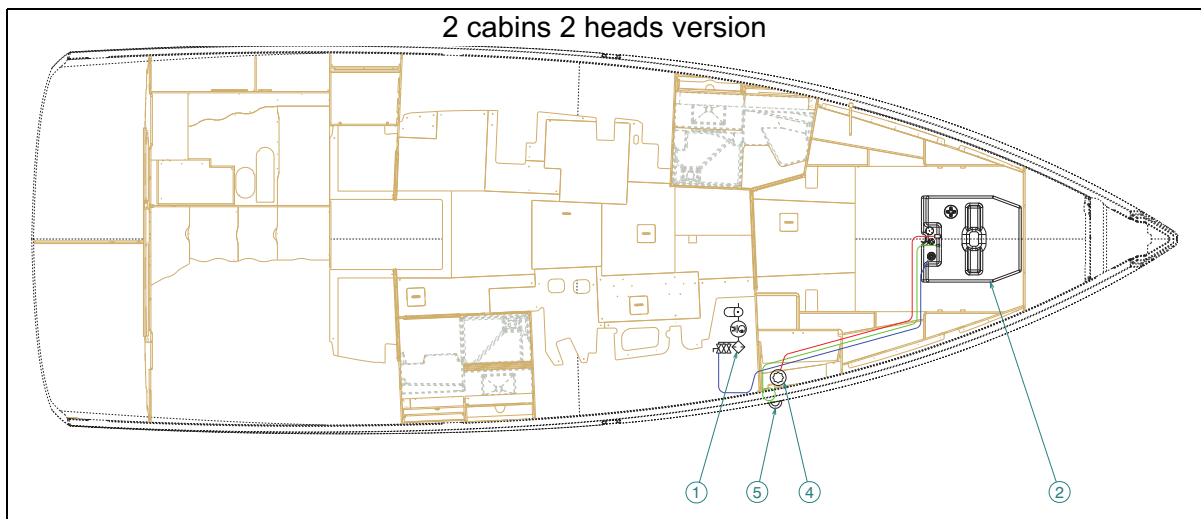
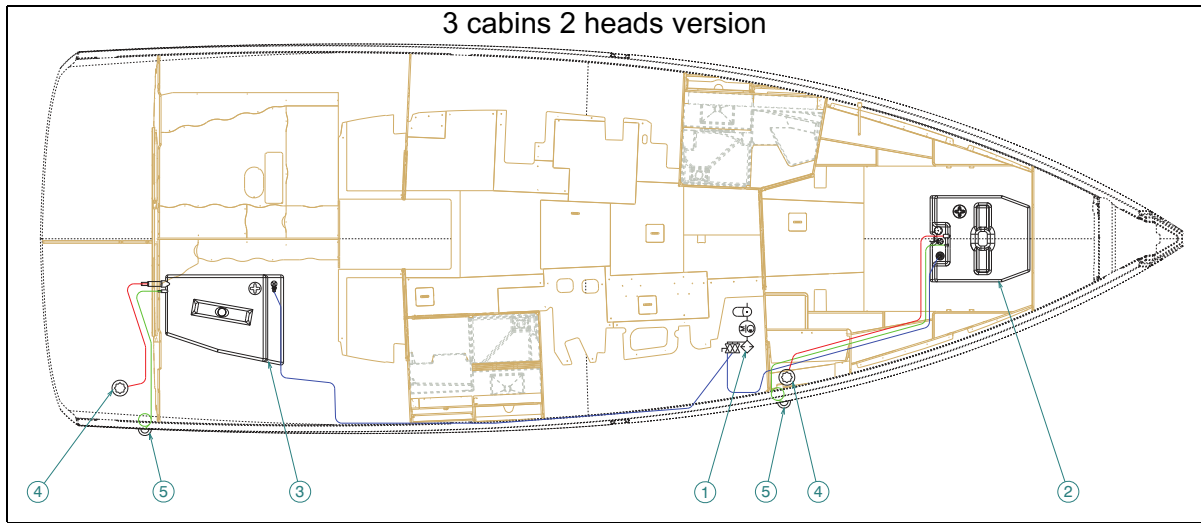

Beware of any draining by inadvertence.

### 13.3 FRESH WATER FILLING SYSTEM

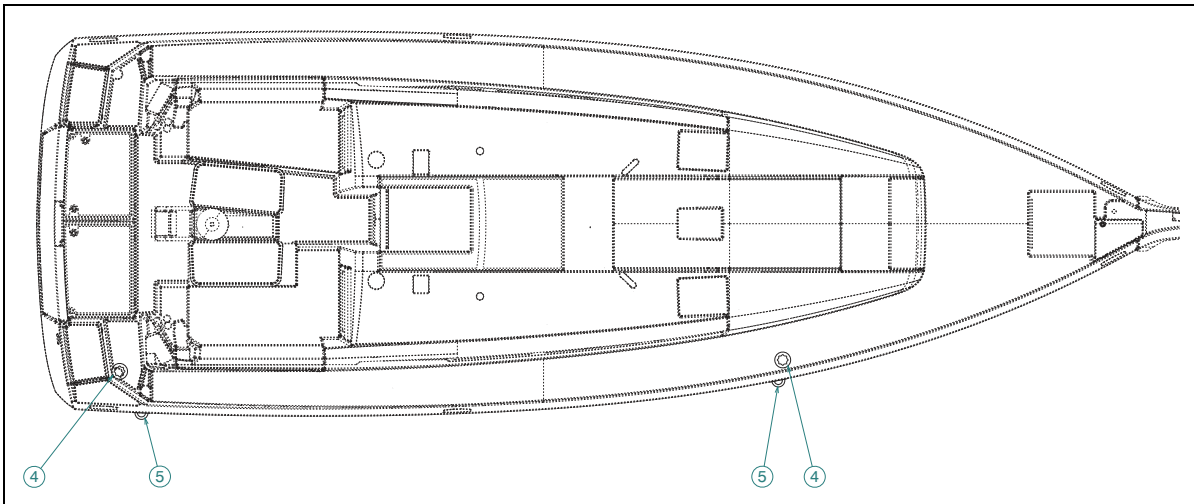



	Supply pipe
	Vent pipe
	Pipe filling

Reference	Designation
1	Plumbing diagram
2	Fresh water tank - forward (330 L)
3	Fresh water tank - aft (200 L)
4	Deck filler
5	Water tank vent

Relationship between the tank number, its position and the gauge (on the electrical panel):

- n°1: Forward tank
- n°2: Aft tank

Water tank (Forward cabin)



Water tank (Aft cabin)



Gauge: Touch screen



Water tank direction valves  
Location: Starboard saloon





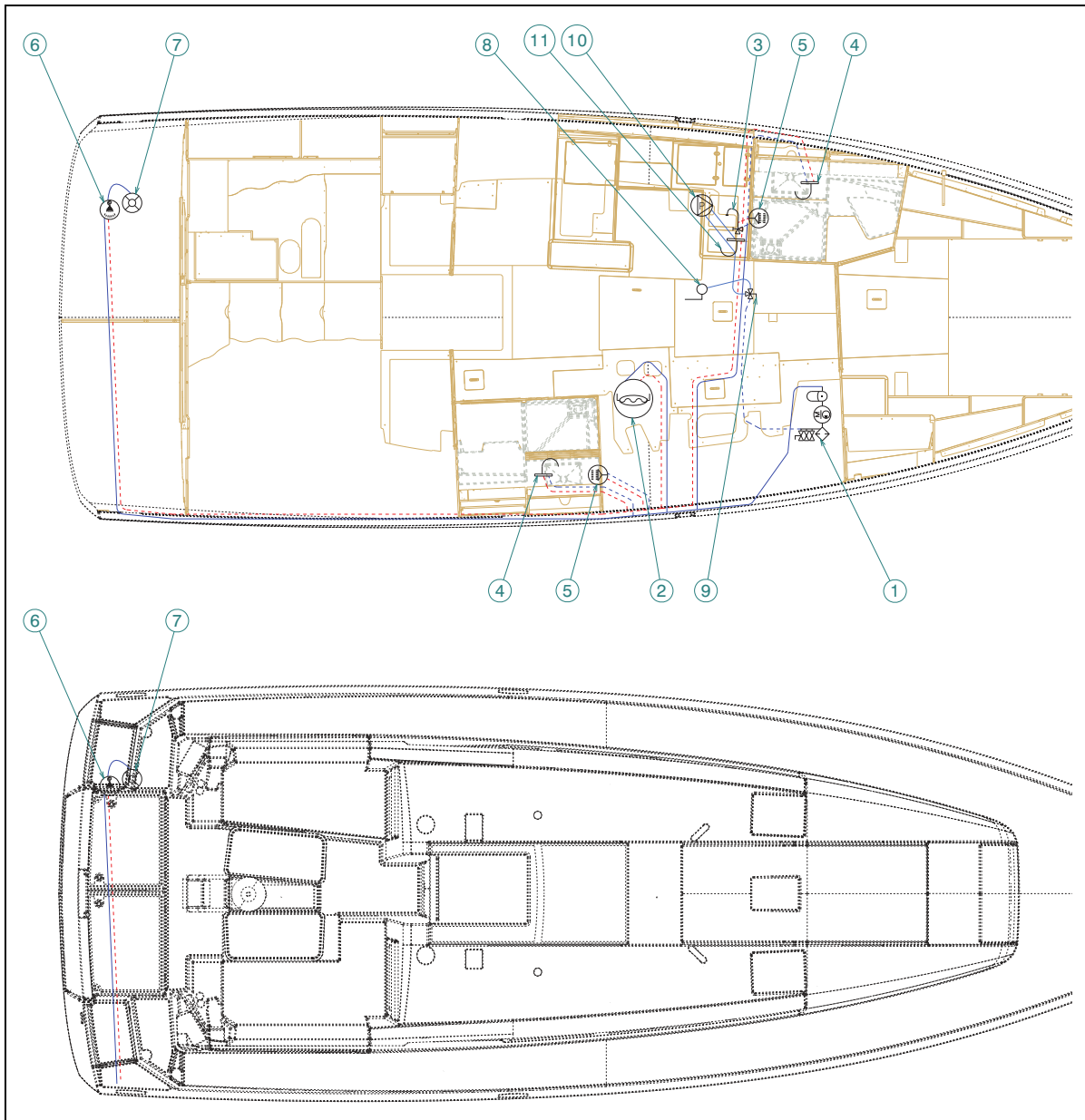

1. Supply valve - Aft tank
2. Supply valve - Forward tank

## 13.4 FRESH WATER DISTRIBUTION SYSTEM







	Connectors
	Cold water hoses
	Cold water hoses
	Hot water pipe
	Hot water pipe

Reference	Designation
1	Plumbing diagram
2	Water heater
3	Galley sink
4	Head washbasin
5	Shower
6	Cockpit shower
7	Shore freshwater supply
8	Sea water intake (Foot pump)
9	Valve to select fresh water / sea water (Foot pump)
10	Foot pump
11	Spout

---

## 13.5 MAIN PLUMBING EQUIPMENT

### 13.5.1 Water unit

- The water unit is supplied by direct current.
- It serves to feed all the boat's plumbing equipment with fresh water. It is fitted with a pressure switch that activates the flow when the pressure in the water system falls.
- The water unit must only be used with the fresh water supply. All other use (with sea water or bilge water, with oil products) is prohibited.
- The water unit is switched on at the electrical panel.
- Make sure that the water unit is never run dry.
- The pressure and capacity of the water unit depend on the temperature of the stored fresh water supply.

Location: Starboard saloon



1. Fresh water filter
2. Water unit
3. Expansion tank

### 13.5.2 Cockpit shower

- The cockpit shower allows the use of fresh water for rinsing off.
- The shower is fitted with a mixer tap.
- The tap has a dual function:
  - It allows the water to be turned on/off,
  - It allows a choice of water temperature.

#### Operation

- To use the shower, turn on the water by tipping the tap on its axis.
- Then press the button on the top of the shower to allow the flow of water.
- Choose the required temperature by turning the tap clockwise or anti-clockwise.
- After using the shower, it is important to turn off the water by tipping the tap on its axis.



---

### 13.5.3 Deck wash pump (sea water/fresh water)

- The deck wash pump is supplied by direct current.
- The deck wash pump allows the deck or the boat's tender to be washed.
- The deck wash pump is switched on at the electric panel.
- Siting of the sea water/fresh water selector valve: Sail locker.

#### Operation

- Open the sea water intake valve.
- Select sea water/fresh water supply.
- Attach a hose to the connector provided in the cockpit.
- Start the pump.

Pipe connection: Chain locker



3 way valve (Selection valve seawater / water from tanks)



Layout of components: Sail locker



1. Deck wash pump
2. Sea water filter
3. Sea water intake

Diagram of the layout - Deck wash pump

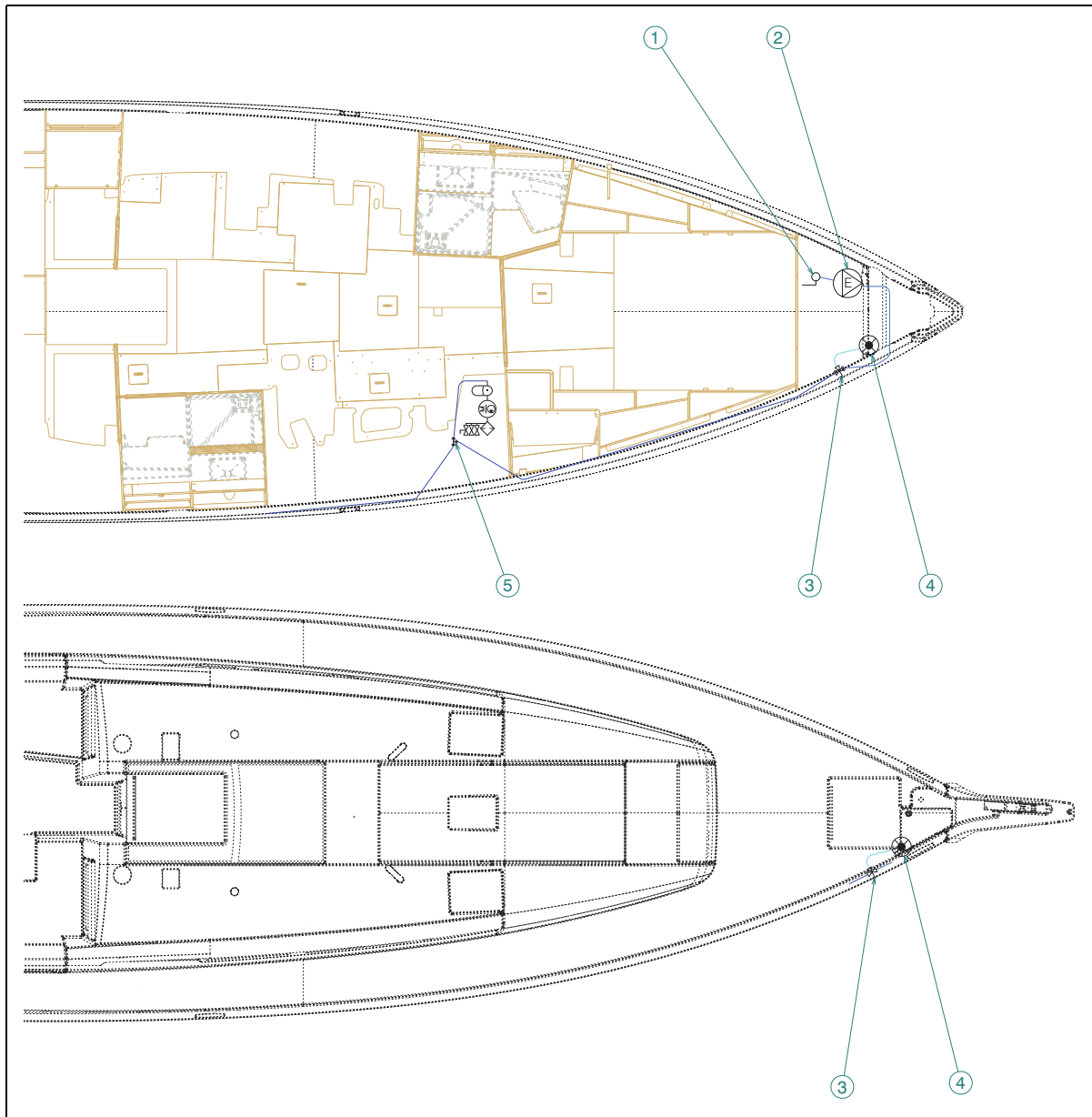

Reference	Designation
1	Sea water intake
2	Pump + Sea water filter
3	Valve to select fresh water / sea water
4	Connecting bridge washing
5	Connection

---

## 13.5.4 Shore freshwater supply

### General points

There are two possibilities for feeding the fresh water circuit of the boat:

1. via the water unit supplied by one or more water tanks,
2. by fresh water taken from the dock.

These two possibilities of supplying fresh water circuit of the boat are independent from each other.

#### **1. Supply of the fresh water circuit by the water unit and the water tanks**

- Open the valve of the desired water tank located near the water unit (if the boat has several water tanks, it is advisable to open only one valve at a time).
- Switch on the water unit.

#### **2. Supply of the fresh water circuit by taking fresh water from the dock**

- Connect a water pipe to the dock water connector.
- Open the water supply tap located on the pontoon.
- The shore fresh water supply arrives directly into the fresh water plumbing system via the water unit, without passing through the tanks.
- A non-return valve in the distribution circuit allows the shore supply water to be used without opening the valve.
- The connection of the water intake is located in the cockpit.



Disconnect shore water supply before leaving the boat.

### **NOTES**

- The water from the dock arrives directly under pressure, into the on board water circuit. It is not necessary to switch on the water unit.
- It is not possible to fill up the water tanks by the dock water supply

### 13.5.5 Sea water/fresh water foot pump

- The foot pump allows the use of sea water/fresh water without needing electricity.
- Water from the foot pump comes out at the spout located at the sink.

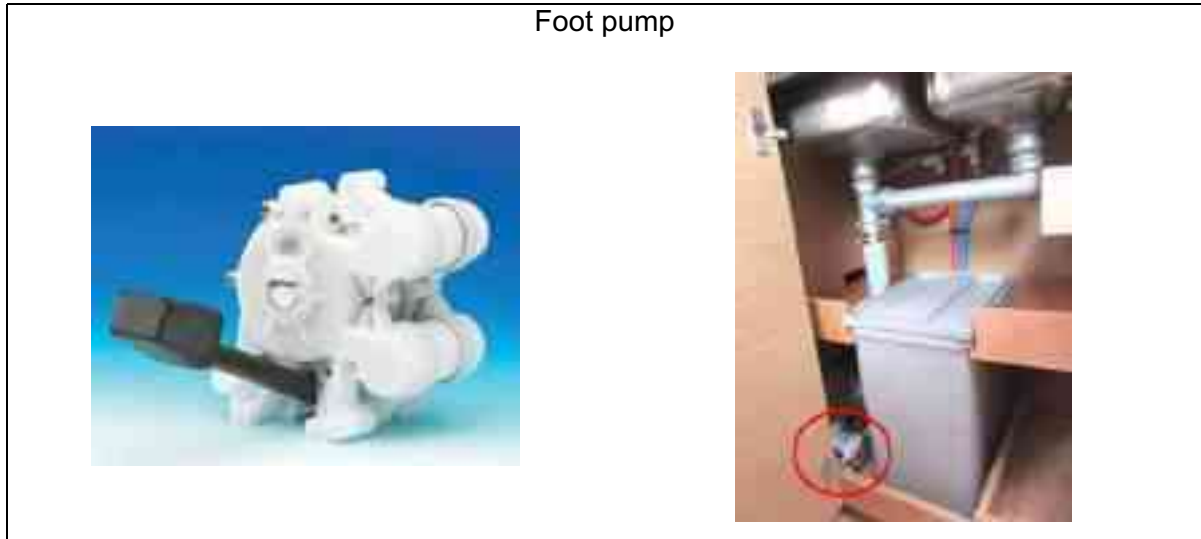

---

### 13.5.6 Water heater

- The water heater allows the use of hot water on board the boat.
- The water heater operates by heat recovery from the engine cooling circuit or the on board AC electrical supply.
- The water heater thermostat regulates the water temperature only when it is operating with electrical resistance. The thermostat is pre-set in the factory.
- The mixer tap allows the temperature leaving the water heater to be adjusted.
- Never switch on the water heater if it is not filled with water.

Location: Saloon



1. Water heater (40 L)
2. Mixer tap



Refer to the manufacturer's instructions for use and maintenance.





### 13.5.7 Water maker

#### General points

- The watermaker allows fresh water to be produced from the sea water.
- The watermaker can be supplied either:
  - by DC direct current,
  - by AC alternating current.
- A circuit-breaker protects the circuit.
- Several elements make up the watermaker circuit:
  - sea water intake,
  - sea water filter(s),
  - circulation pump,
  - electric valve for automated rinsing,
  - manual rinsing valve,
  - motor block and high-pressure pump,
  - membrane block,
  - control panel,
  - sea water discharge valve.

#### Operation

- Sea water enters the membrane block under pressure, which allows only pure water to pass out.
- A sensor at the membrane block exit allows the measurement of the salt content of the water filtered in this manner. A three-way valve allows drinking water to be directed automatically to the tanks or water that is too salty to be discharged to the sea.
- The drinking water filtered by the membranes is sterile; it is advisable to treat it with a weak dose of chlorine from time to time and to mineralise it if consumption is prolonged.
- Fresh water production depends on the temperature of the sea water used and the cleanliness of the filter.

#### Operation

- Before starting the watermaker circuit, check that the supply and discharge valves are open.
- Using the watermaker with DC supply needs a lot from the battery bank: make sure to recharge them regularly by running the boat's engine.
- The different quality and salinity of the sea water used affect the production of fresh water; it is advised not to use the watermaker in navigation areas or where the water is muddy, polluted or brackish.
- The membranes are temperature-sensitive; in the event of negative (0°C and less) or too hot (60°C and over) temperatures, the membranes are likely to tear.

---

## Maintenance

- Every week, rinse the system with fresh water. Two methods can be used according to choice: one manual, the other automatic. The fresh water used for rinsing the circuit must not be under pressure to avoid damaging the membranes.
- Every 6 months, the sea water filter must be changed.
- When the watermaker is not being used for a long period, rinse the system every month or sterilise the membranes.

Motor unit

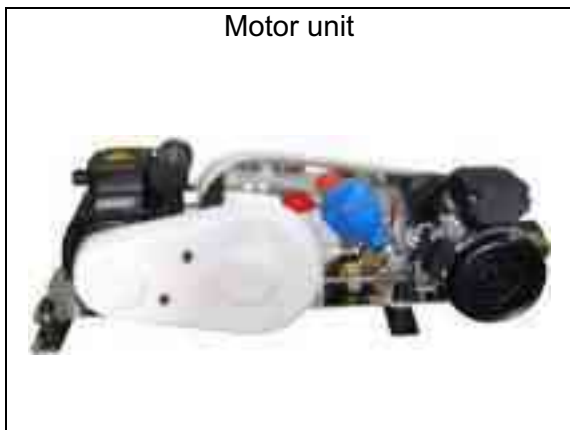

Control panel



Sea water filter



Electromagnetic valve



Membrane block

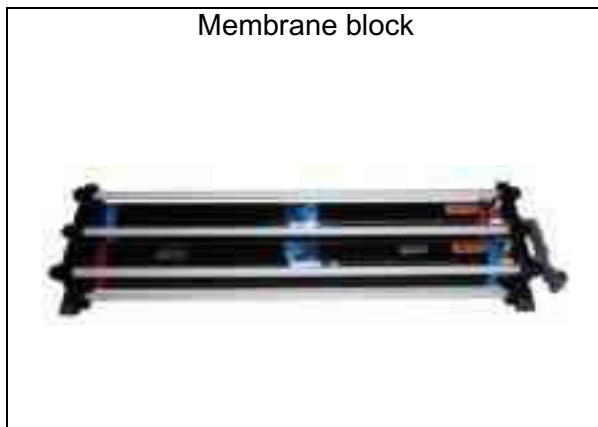

Layout of components

General layout



Sea water intake



Seawater discharge





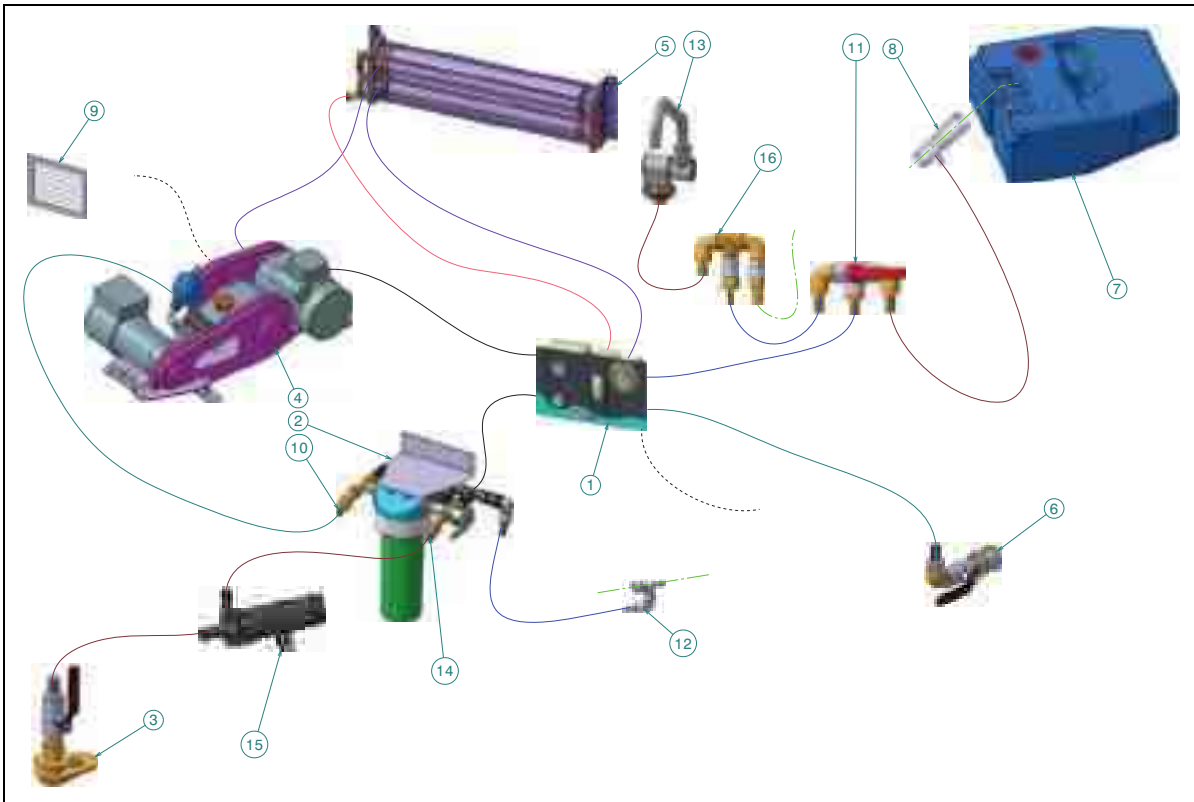



## Layout diagram

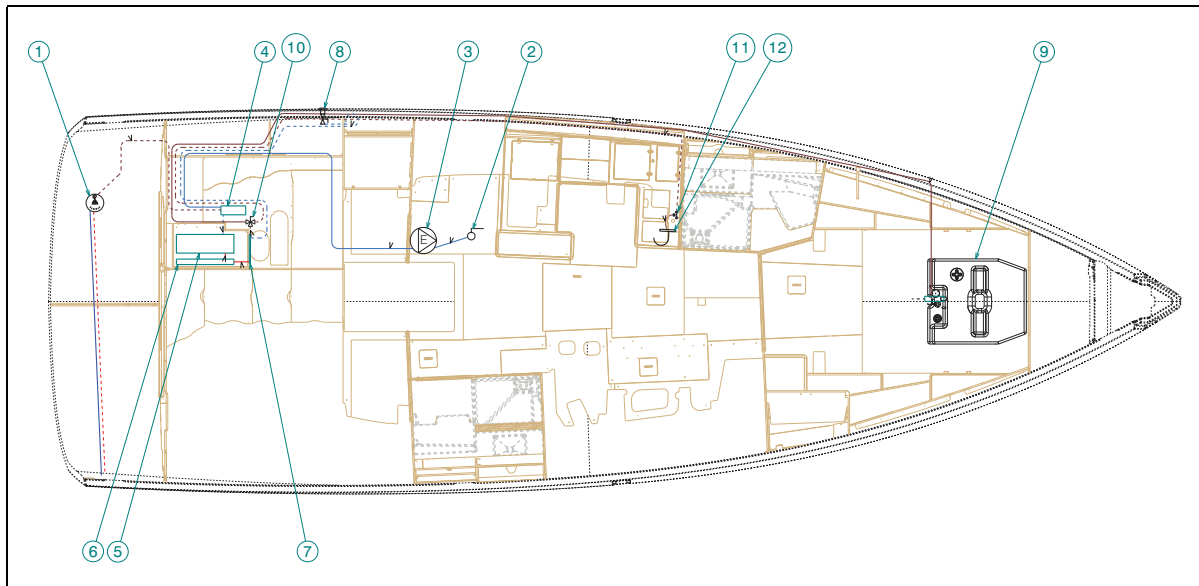

Reference	Designation
1	Control panel
2	Sea water filter
3	Sea water intake
4	Water maker
5	Membrane block
6	Seawater discharge
7	Fresh water tank
8	Tee
9	Ventilation grids
10	Connection
11	3 way valve
12	Tee - Fresh water supply
13	Spout
14	Connection
15	Pump sea water
16	Tee

### Diagram of the layout



	Watermaker hose - 16 mm diameter (Sea water)
	Watermaker hose - 12 mm diameter (Sea water)
	Watermaker high pressure hose
	Watermaker hose - 16 mm diameter (Fresh water)
	Watermaker hose - 12 mm diameter (Fresh water)

Reference	Designation
1	Cockpit shower
2	Sea water suction valve
3	Booster pump
4	Seawater pre-filter
5	Motor unit (Water maker)
6	Membranes
7	Control panel
8	Draining valve
9	Fresh water tank
10	3 way selector valve
11	Tee (Foot pump + Water maker)
12	Spout (Galley)

## 13.6 BLACK WATER SYSTEM (WC)





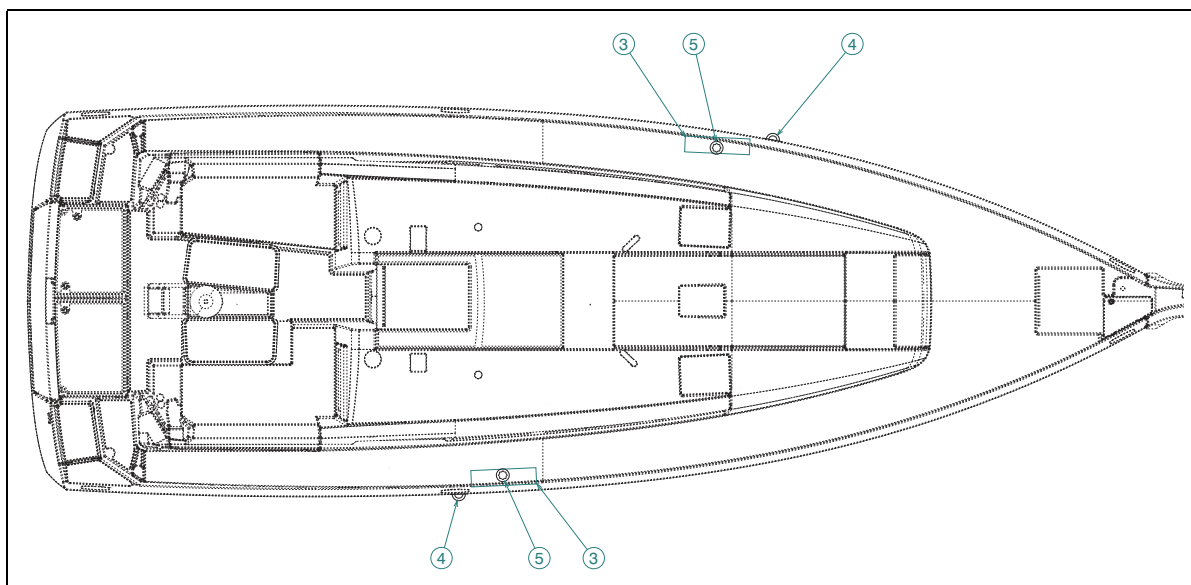

### General points

- Black water is human waste including the flushing water from the toilets.
- Close the valves after each use and above all when the boat is unattended.
- Regularly check the valves and thru-hull seacocks for proper operation and watertightness.
- Regularly check the tightness of the flexible pipe clamps and connections.

### 13.6.1 Location diagram of black water system





	Pipe - Black water tank
	Seawater supply pipe
	Suction hose - Sewage
	Pipe - Sewage drainage
	Pipe - Sewage drainage
	Pipe - Sewage drainage

Reference	Designation
1	Seawater intake valve (WC)
2	WC
3	Black water tank
4	Black water tank
5	WC deck drain filler
6	Sea discharge valve
7	Pump - Electric toilet
8	Electric toilet (Sea water)
9	Connection
10	Control - Electric toilet

---

## YOUR BOAT IS FITTED WITH A BLACK WATER TANK

To minimise the smells coming from this tank, we advise the following use and maintenance:

### 1) Holding tank

- A black water tank is used solely for the temporary collection of water coming from the toilets.
- The tank can be emptied in 2 ways:
  - By connection to a pumping system that empties the tank by suction. This system uses the "WASTE" deck connection.
  - Via the thru-hull fitting emptying directly into the sea (under the conditions permitted by the laws of the country in which the vessel sails, if they permit dumping into the sea).
- Only use water soluble toilet paper to avoid any blockage.

*Note: Sanitary towels and other items (paper handkerchiefs, dressings etc) in the toilets and black water tank will inevitably lead to blockages.*

- Faecal matter causes formation of unpleasant odours in the black water tanks, to which the use of salt water for flushing the toilets also contributes. Algae present in salt water also give off unpleasant odours.
- Completely empty the black water system before leaving the vessel unattended in temperatures below freezing.
- Ask for information about the laws in force in your country or your marina about discharging your waste waters into the sea.







## 2) Use of toilets

- Every time the toilets are used, flush afterwards with copious amounts of water in the bowl using the toilet pump (manual or electric).
- When you are leaving the boat for several days, flush with fresh water, using for example the head's shower. Sea water that stagnates in the bowl gives off bad smells.

## 3) Maintenance of black water tank

- The risk of unpleasant odours forming increases when the waste water remains in the tank for a long time.
- Whenever possible empty the tank regularly even before it is full.
- Every time the tank is emptied put in about 5 litres of fresh water and add an appropriate detergent additive (available from chandleries). A very simple method is soda salts, which clean and disinfect at the same time.
- Before winterising, flush the tank with copious amounts of fresh water filling it through the 'WASTE' deck connection. Leave at least 5 litres of fresh water mixed with a detergent additive.
- Disinfecting: Disinfect the tank once a year by filling it with a solution of Javel water (1 to 1000).



- Never use automobile anti-freeze in the black water system: risk of poisoning.

### **ADVICE-RECOMMENDATION**

- Respect local regulations regarding the emptying of black water tanks.

---

4) Using the drainage valve

- The direct drainage to the sea valve can be plumbed by means of the drilled hole on the handle.
- Blockage of the drainage valve in closed position: Pass the tightening collar around the drainage valve and in the hole in the handle.

Plastic valve



Beware of any draining by inadvertence.

**Layout diagram of black water system**  
**Emptying by gravity**

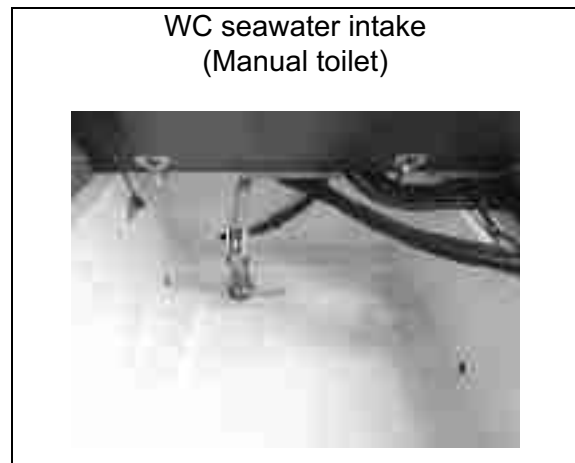
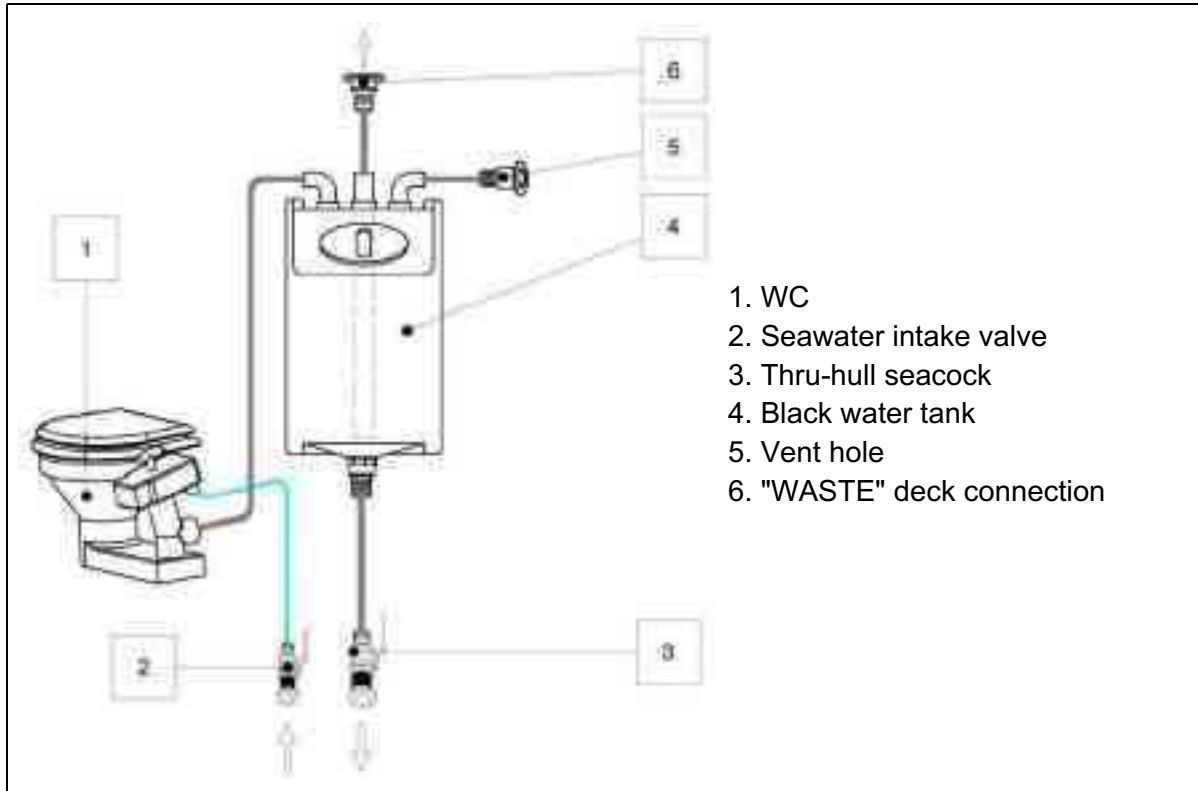

---

### **Using a marine toilet fitted with a tank emptied by gravity**

- I. Open the sea water intake valve (Ref 2).
- II. Fill the bowl by using the manual toilet pump.
- III. Using the toilet (Ref 1).
- IV.a. To empty the organic waste in the tank:
  - Make sure the thru-hull seacock (Ref 3) is closed.
  - Empty the bowl using the manual toilet pump.
- IV.b. In the case of a direct discharge into the sea:
  - Open the thru-hull seacock (Ref 3).
  - Empty the bowl using the manual toilet pump.
- IV.c. To discharge through the deck:
  - Open the deck connection marked "WASTE" (Ref 6).
  - Use the pump-out system where fitted at a port.

**Using an DC electric WC fitted with a tank emptied by gravity**

The WC is supplied with onboard fresh water.

I. Fill the bowl by pressing the fill button.

II. Using the toilet (Ref 1).

III.a. To empty the organic waste in the tank:

- Make sure the thru-hull seacock (Ref 3) is closed.
- Empty the bowl by pressing the empty button.

III.b. In the case of a direct discharge into the sea:

- Open the thru-hull seacock (Ref 3).
- Empty the bowl by pressing the empty button.

III.c. To discharge through the deck:

- Open the deck connection marked "WASTE" (Ref 6).
- Use the pump-out system where fitted at a port.



Refer to the manufacturer's instructions for use and maintenance.

Control



Electromagnetic valve  
Location: under the washbasin (Head)



---

## 13.7 WASTE WATER SYSTEM

### General points

- The waste water system is the water coming from the sink, showers, air conditioning drains and washbasins.
- Close the valves after each use and above all when the boat is unattended.
- Regularly check the valves and thru-hull seacocks for proper operation and watertightness.
- Regularly check the tightness of the flexible pipe clamps and connections.

### Layout of components

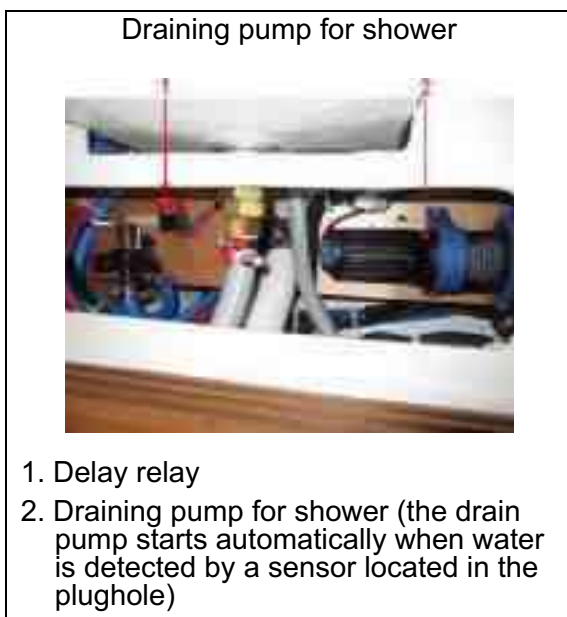



### ADVICE-RECOMMENDATION

- Observe local regulations regarding the emptying of grey water tanks.

### 13.7.1 Diagram of waste water circuit installation



	Waste water pipe
	Waste water pipe
	Waste water pipe

Reference	Designation
1	Sink plug hole (Galley)
2	Washbasin drain plug (Head)
3	Shower plug hole
4	The shower pump control
5	Shower pump
6	Hand spray evacuation valve
7	Sink plug hole (Cockpit)
8	Sink drainage valve (Cockpit)





## 14 ENGINE

### 14.1 INFORMATION ABOUT THE RISKS OF FIRE AND OF EXPLOSION OF ENGINES

- Make sure that the coolant is circulating properly.
- Ensure that the engine compartment ventilation air inlets are kept clear.
- Stop the engine and refrain from smoking during fuel tank filling.
- Get your fuel circuit checked regularly by a professional engineer.
- Avoid any contact between inflammable materials and the hot sections of the engine.
- Never switch off or de-energise the electric system when the engine is running.
- Never block the access of the fuel supply valve.
- Do not obstruct or modify the ventilation system.
- Never turn the engine over when the boat is on land.
- Fuel stored outside the tanks (jerrycans, portable fuel tanks, etc.) must be stowed on deck, protected from bad weather and mechanical damage.
- Regularly check that the engine compartment is clean and dry.



### 14.2 DANGER FROM MOVING MECHANICAL PARTS

- Keep away from the moving parts of the engine (belts and moving parts or hot components) and the drive shafts etc..
- Be careful if you have long hair, bulky clothing, rings etc (at risk of being caught).

---

### 14.3 GENERAL POINTS

- Don't install an engine more powerful or heavier than recommended on this boat, this risks compromising the boat's stability.
- Any alteration or modification to the exhaust system of the propulsion engine(s) is prohibited.
- Make sure you have enough fuel before sailing.
- Stop the engine before opening the engine compartment.
- Don't close the fuel supply valve between each use of the engine (unless for a lengthy absence).
- Get the whole propulsion system checked at least once a year by a professional engineer. (see Chapter: MANOEUVRABILITY).

**Always start the engine with the control lever in neutral.**

#### Type of motorisation

Your vessel is fitted with an in-board diesel engine.

The transmission is of a shaftline type.

#### Filling up with fuel

- Fill the fuel tank by opening the cap marked "DIESEL", provided for this.
- Arrangement of fuel tank(s): Port aft cabin.
- Regularly check that the O ring on the filler cap is in good condition, to prevent any water ingress.
- The generator has its own fuel supply valve.

#### Choice of tank

- A pull control enables you to select which fuel tank to use to supply the engine.

Lever pushed: fuel supply from the port tank.

Lever pulled: fuel supply from the starboard tank.

## Gauge

- The fuel level is transmitted from the dipstick to the indicator located on the electrical panel.
- Some of the gauges must be calibrated when you first fill the tanks: please consult your dealer.



- The tanks' nominal capacity cannot be fully used due to the load and the need to maintain the correct trim. A 20% reserve should be kept.

### **ADVICE-RECOMMENDATION**

- Regularly check that the O ring on the filler cap is in good condition, to prevent any water ingress.
- Keep the fuel tank as full as possible to prevent condensation.
- Be careful with any possible risk of oil and fuel spillage.
- Follow the engine manufacturer's instructions exactly.
- **Never switch off the battery breakers when the boat's engine is running (risk of serious damage to the charging circuit).**

---

## 14.4 STARTING THE ENGINE

Before starting the engine, it is imperative:

- to open the fuel supply valve;
- to open the sea water intake valve of the engine;
- to open the sea water intake seacock for the stern gland;
- to switch on the battery supply by using the battery isolator switches;
- to put the control lever in neutral.

Make a habit of looking to see if sea water is pumped out with the exhaust gases as soon as you start the engine. If no water runs out, stop the engine immediately. Check the coolant flow.

The engine compartment bilge fan is activated automatically when the engine is started.



- Before using the engine, make sure you carefully read the handbook provided by the engine manufacturer.



- Always start the engine with the control lever in neutral.
- Learn how to judge the necessary distance of deceleration for the vessel to come to a complete stop (The reverse gear is not a brake).

## 14.5 ENGINE WATER INTAKE VALVE

- The sea water intake valve plays a crucial role in ensuring that the engine runs well.
  - Keep the strainer under the hull as clean as possible;
  - brush the strainer whenever the boat is lifted out.
- This valve must absolutely always be opened before starting the engine.
- A sea water filter filters the water before it goes through the heat exchanger.
- Regularly inspect the sea water filter and clean it if necessary. Screw/unscrew the cover of the filter by hand (never use tools for this).
- For lengthy absences, close the engine's sea water intake valve.



---

## 14.6 ANTI-SIPHON VALVE

- The function of the anti-siphon valve is to inhibit the siphoning action when the engine stops thus preventing a return of water.
- It is possible that on starting the engine or at certain engine speeds some drops of water may be seen escaping from the anti-siphon valve.  
If so you need to clean the anti-siphon valve: dismantle the water collector at the top of the anti-siphon valve, then clean the valve with fresh water to remove any impurities.
- Then do the reverse procedure to refit the cleaned component, taking care not to refit the valve the wrong way round.
- This simple preventative maintenance procedure of the anti-siphon valve is recommended to be carried out once a year.



## 14.7 FUEL FILTER

Engine running problems may have different origins, including dirty fuel. The injection pump may wear out if there is water in the system. The water results either from the condensation resulting from an insufficiently filled tank, or from a filler cap either not closed properly or with a damaged seal.

In order to prevent any water infiltration, the fuel runs through two filters:

- One filter is an integral part of the engine, its role is to filter fuel very finely. Please refer to the engine manufacturer's notes for any maintenance and for the frequency of filter changes.
- The second filter is on the pipe that links the tank to the engine, it plays the role of a water decanter and prefilter.

### Maintenance

- Purge the impurities by unscrewing the screw located at the base of the decanting bowl (without removing it). Let the liquid run into a receptacle until the fuel runs clear. Do this several times a year.
- Change the pre-filter at least once a year.



## 14.8 ENGINE INSTALLATION

### INSTALLATION OF SHAFT ENGINE WITH BRACKET



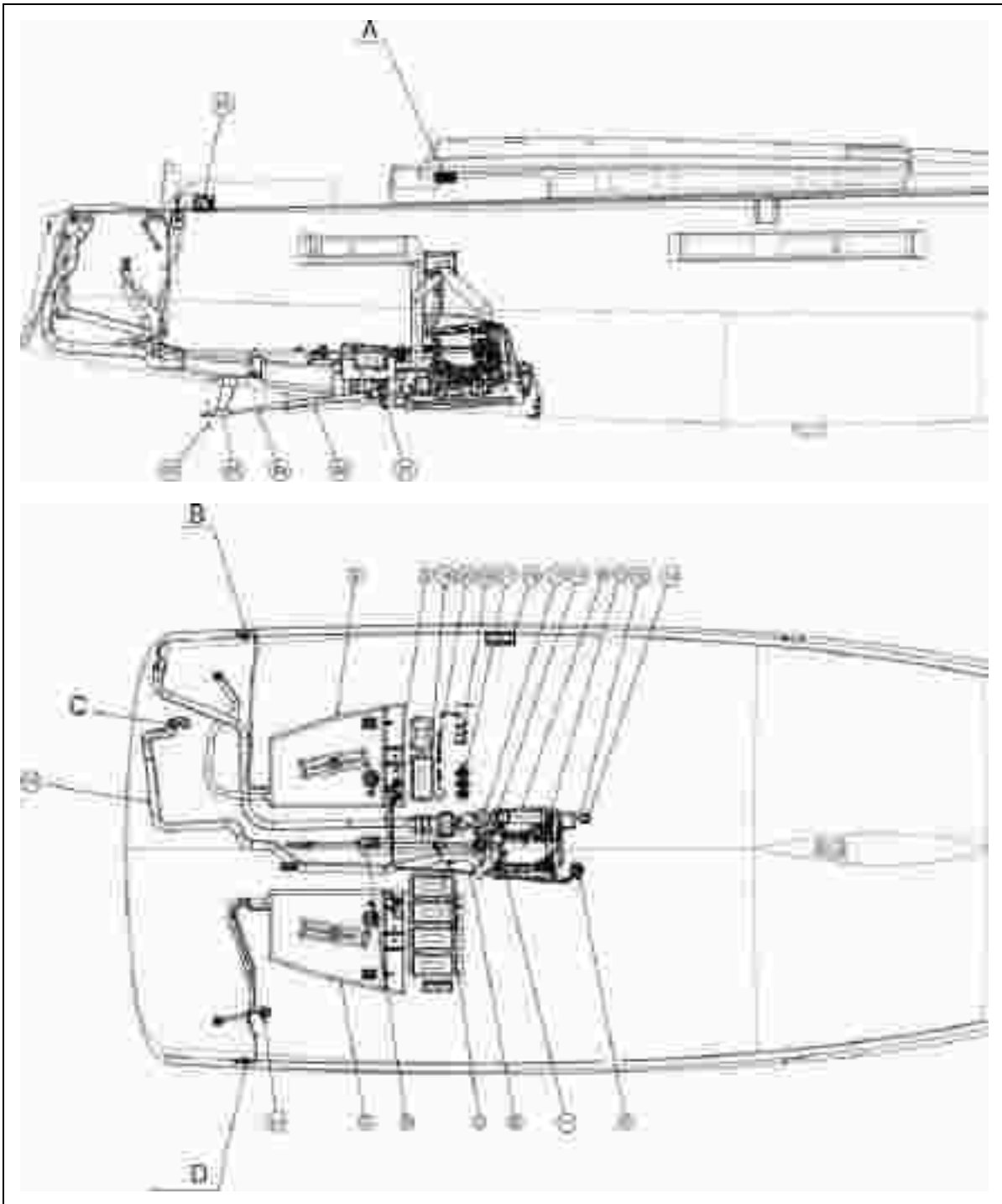

Reference	Designation
A	Fresh air inlet
B	Tank vent hole
C	Hot air exit
D	Additional tank vent





Reference	Designation
1	Motor
2	Outlet
3	Fuel tank
4	Auxiliary fuel tank
5	Fuel supply valve
6	Fuel feed pipe
7	Fuel filter
8	Fuel supply selection mechanism
9	Fresh air pipe
10	Hot air pipe
11	Engine compartment fan
12	Cooling water pipe
13	Sea water inlet valve for engine
14	Engine seawater filter
15	Anti-siphon valve
16	Engine battery
17	Control panel of the battery switches
18	Circuit breakers
19	Power distributor
20	Fuses
21	Engine control lever
22	Engine instrument panel
23	Propeller
24	Propeller shaft
25	Bearing
26	Sternpost
27	Sea water inlet valve of stuffing box

---

## 14.9 ENGINE CONTROL

- The engine manufacturer's notes provide detailed explanations on how to operate the engine and keep it running well.
- Read the manufacturer's notes on use and maintenance of the engine.

Engine control lever



Engine instrument panel



## 14.10 ACCESS TO THE ENGINE

The access to the engine is via:

- Side hatches,
- the companionway.

All access hatches to the engine absolutely must be kept shut when at sea.

### 14.11 PROPELLER SHAFT

- The shaft is stainless steel.
- The shaft is aligned in the factory. When the boat is launched, a check is to be made by a professional.
- A hydrolube ring keeps the shaft line at the hull outlet / in line with the cradle.

This is a wearing ring. Check the hydrolube bush every time the boat is slipped. Change the hydrolube bush if necessary.

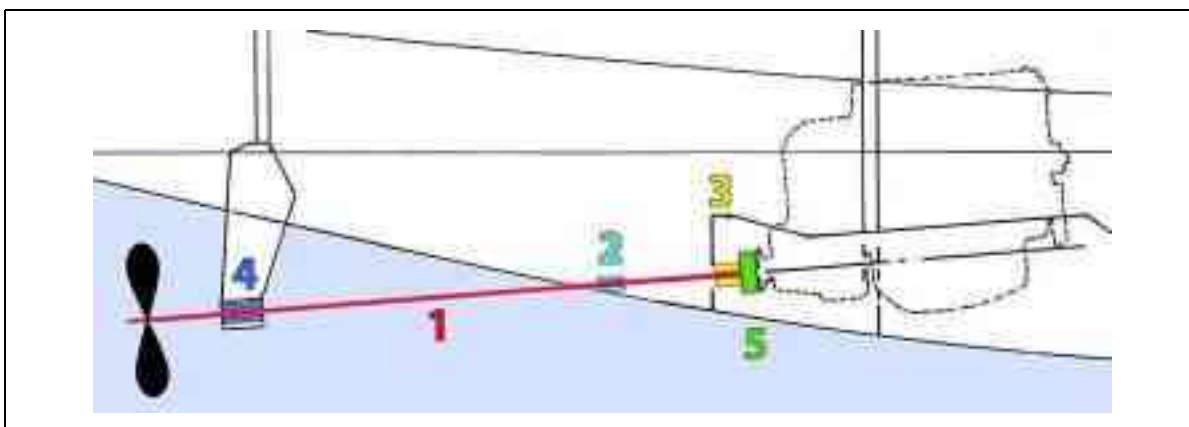

Reference	Designation
1	Propeller shaft
2	Stuffing box
3	Flange
4	Hydrolube bush
5	Flector

---

## 14.12 STUFFING BOX

- The stern gland keeps the propeller shaft watertight.
- The stern gland is accessible through the engine compartment.
- Grease the watertight joint every 200 engine hours (or at least once a year). Apply grease as recommended by the mechanic.
- The stern gland is lubricated directly by the engine cooling water/by a sea water supply valve.
- After launching the boat, drive the air out from the sleeve pinching it with your fingers.

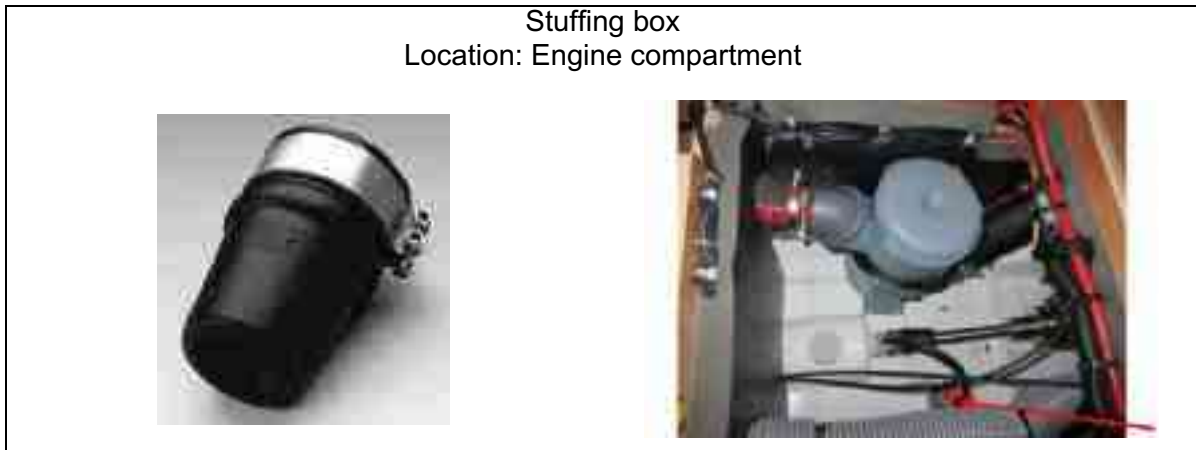

## 14.13 PROPELLER

- The propeller delivered with the boat represents the end result of trials carried out in collaboration with the engine manufacturer. Never change the propeller without first consulting a professional engineer.
- Propeller efficiency will drop if the propeller blades are damaged in any way or dirty: regularly clean the blades carefully.
- During a lift-out, check the propeller: it should turn freely on its axis and there should be no play.
- Single-engined boats are equipped with a right-hand pitched propeller.



- Respect speed limits.
- If this boat is equipped with a fixed blade propeller, when sailing at speeds over 8 knots it is essential to leave the reverse gear control in neutral.



## 15 STEERING SYSTEM

### 15.1 GENERAL POINTS

- The steering operates by steering cables.
- The steering system is an important safety feature. For this reason, the annual inspection of the whole system must be carried out by a professional engineer.
- Regularly check the tension of the steering cables and the tightness of the steering components. If need be, adjust the tension of the steering cables. Don't tighten the steering cables excessively. When properly adjusted the steering should work smoothly, with no play at all and no stiffness in the tiller or wheel (consult your dealer).
- Do not grease the steering cables or the pulleys.
- Maintain the nylon, ertalon or teflon bushes with only a suitable lubricant.
- Each ring is a wearing part: make sure you change them regularly (Please contact your dealer).



The textile lines on the boat have a lifetime of 5 years. Beyond 5 years (the expiry date is sewn on the textile lines) the textile lines must be changed.

## 15.2 LAYOUT DIAGRAM

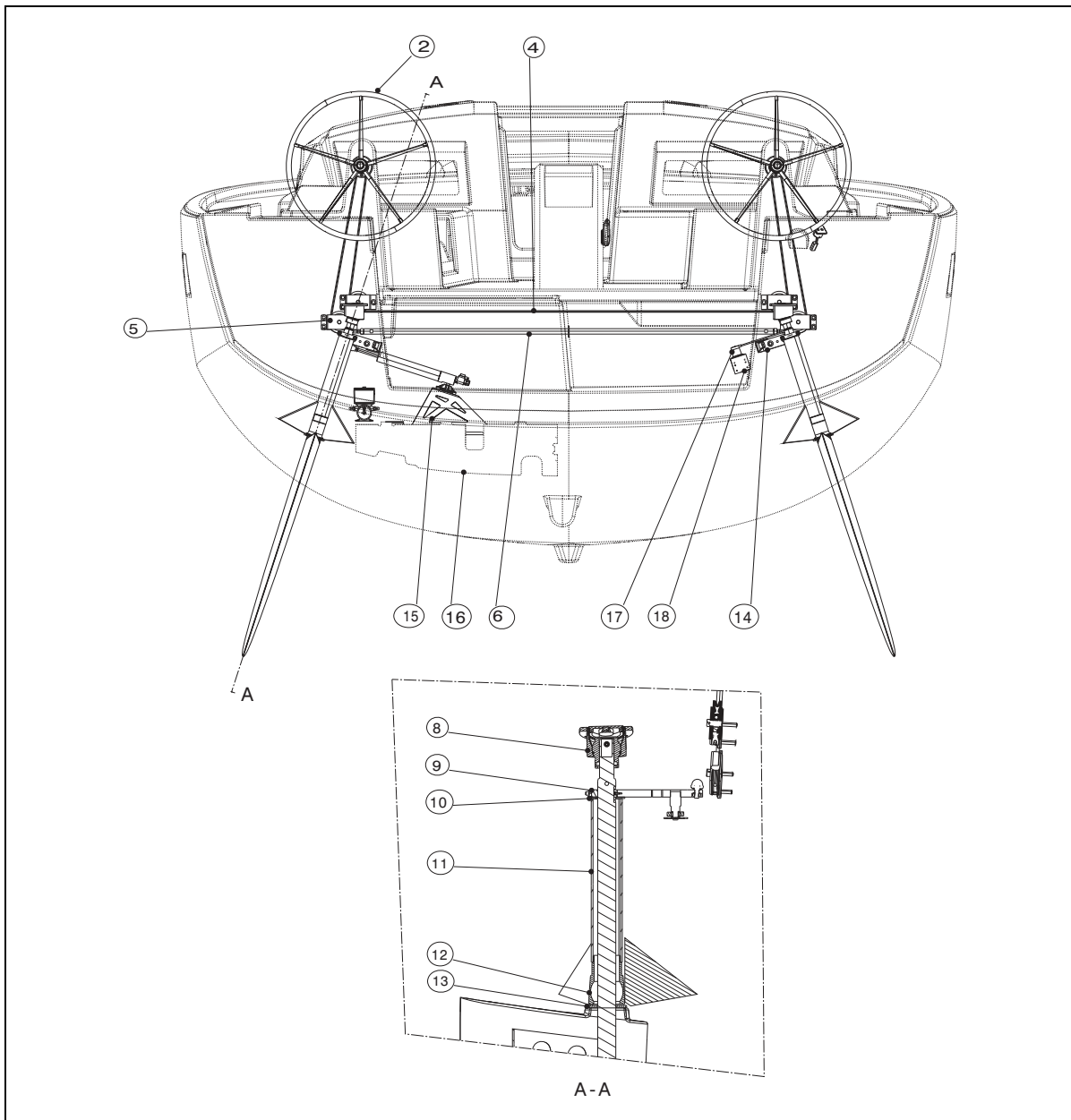

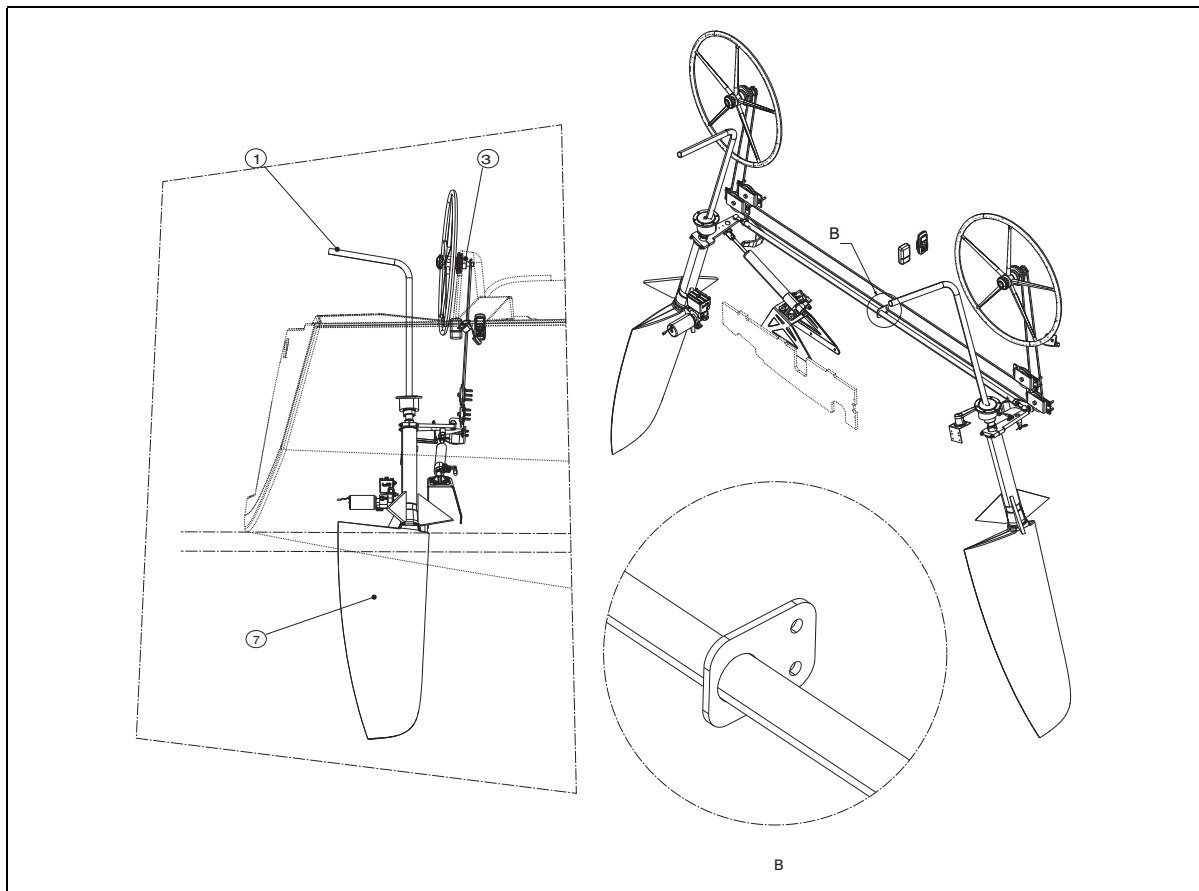

Reference	Designation
1	Emergency tiller
2	Steering wheel
3	Steering Gear
4	Ropes (fabric)
5	Sheaves
6	Connecting rod
7	Rudder
8	High rudder bearing
9	Stock arm
10	Friction ring
11	Rudder port tube
12	High rudder bearing
13	Balance bush
14	Stock arm stop
15	Autopilot ram
16	Wooden support
17	Tiller angle indicator
18	Helm angle indicator support

---

## 15.3 BOW THRUSTER (RETRACTABLE)

### General points

- The bow-thruster's motor is DC powered.
- The bow-thruster assists with steering the boat when manoeuvring at low speed (picking up a mooring buoy or berthing on a pontoon for instance).
- An operating relay is installed in the circuit.
- A fuse protects the electrical circuit.
- The bow-thruster motor has its own battery bank.

### Operation

- Turn on the bow thruster battery switches.
- The engine's positive battery isolator automatically comes on and goes off when the engine is started/stopped. The thruster circuit negative is connected to the boat's general negative.
- The bow-thruster motor must operate with the boat's engine running.
- A control panel is located in the cockpit.
- To switch the bow-thruster motor on or off, press and hold in the red and green button simultaneously for several seconds.
- When the bow-thruster motor is not in use, switch off the electrical supply both:
  - to the control panel,
  - and to the switches of the motor's batteries.

### Maintenance

- The bow-thruster's motor:
  - is lubricated for life and the oil does not require draining;
  - must not be dismantled, even partially.
- Regularly check the charge state of the motor's batteries: a loss of voltage will cause premature wearing of the motor's relay contacts and brushes.

### During lift-out

- Check that the propellers turn properly, with neither play nor stiffness.
- Clean the blades carefully.
- Remove the propeller, clean the shaft support, smear the shaft with silicone-based grease before refitting the propeller.
- After cleaning and applying a primer, antifoul the housing and the propellers.



Bow thruster



Control: Steering station (Starboard)



Access: Sail locker



1. Bow thruster
2. Retractable nozzle
3. 400A fuse
4. Positive battery isolator switch
5. Batteries

---

Nozzle



### **ADVICE-RECOMMENDATION**

- Refer to the manufacturer's instructions for use and maintenance.
- Never run the motor when the propeller is out of the water.
- In the case of dual control, be careful to use just one control at a time.
- The motor must not run for longer than 3 minutes (risk of overheating).



## 16 DECK FITTINGS

### 16.1 GENERAL POINTS

Alcohol, solvent or acetone based solutions to clean / maintain the outer surfaces of the boat are not to be used. A warm soapy water based solution is preferred.

#### 16.1.1 GRP

- Regularly brush the deck using a gentle de-greasing agent then rinse the deck with fresh water.
- Use as few cleaning agents as possible.
- Don't use solvents or aggressive detergent agents.
- Don't discharge cleaning agents into the water: Consult the harbourmaster's office to find out the conditions of water use and the maintenance area for cleaning your vessel.
- Don't use a pressure washer.

#### 16.1.2 Plexiglas (PMMA)

- Rinse plexiglas with fresh water.
- Use a polish paste for thin scratches.
- Consult your dealer concerning deep scratches.

### ADVICE-RECOMMENDATION

Never use solvents, alcohol, acetone or detergents on the plexiglas.

#### 16.1.3 stainless steel

Stainless steel is an alloy of iron and carbon (steel) with the addition of chromium. This chromium provokes the formation of a protective film which separates the steel from the atmosphere outside. This coating is usually invisible as it's so thin. So in spite of its name this steel is not stainless and requires a minimum of maintenance:

- The use of chrome tools is preferable whenever handling stainless steel;
- Re-nourish the protective film regularly with passivation paste.

#### 16.1.4 Solid wood on exterior wooden panelling

- Wood exposed to harsh conditions, such as salty air and UV rays tends to become whiter and to lose its natural colour. This phenomenon has no effect on the intrinsic qualities of the wood, but can spoil its aesthetic appeal.
- To maintain the colour of the wood, regularly wash the woodwork in fresh water using a sponge (if necessary, use a mild soap).

- 
- It is recommended to oil the external woodwork regularly using teak oil to protect them from the harsh conditions.

### **ADVICE-RECOMMENDATION**

Never use detergents, acetone or other harsh products on the wood.

#### **16.1.5 Exterior upholstery**

- Bring the removable cushions inside (washed with soapy water then dried) when the vessel is unoccupied.
- Put canvas sheets/protective covering over the fixed upholstery.

#### Maintenance

To maintain the quality of the fabric, you are advised to spray it regularly with clarified water and to brush it with a soft brush (brush for clothes). It is advisable to clean thoroughly every 2 years.

#### Stain removal

Follow these steps for routine cleaning:

- Remove as much debris as possible using a soft brush;
- Spray the fabric with water;
- Prepare a cleaning solution using mild soap and water (Do not use detergent);
- Wash with a soft brush;
- Wait for soapy solution to act;
- Rinse thoroughly in fresh water;
- Dry in the open air.



- Beyond 20 knots of Wind, you are advised to stow all removable protection sheets (Bimini, Covers...).

### **ADVICE-RECOMMENDATION**

Never:

- Use a heat source (hairdryer/clothes dryer);
- Use detergent, silicone, acetone, chlorine-based products or hot water;
- Use a high pressure cleaner.

## 16.2 EQUIPMENT

### 16.2.1 Electric platform (Rear skirt)

#### General points

- The platform runs on the DC power supply.
- A circuit-breaker protects the circuit.

#### Operation

##### **Opening of the platform**

- Remove the high lifelines located at the aft of the cockpit,
- Lower the platform using the control in the cockpit or the remote control.

##### **Closing the platform**

- Close the top lifelines located at the aft of the cockpit,
- Raise the platform using the control in the cockpit or remote control,
- Secure the platform with the 2 latches provided for this purpose.

***NOTE: the platform must be completely open or completely closed. The mechanism is not intended to remain in an intermediate position.***

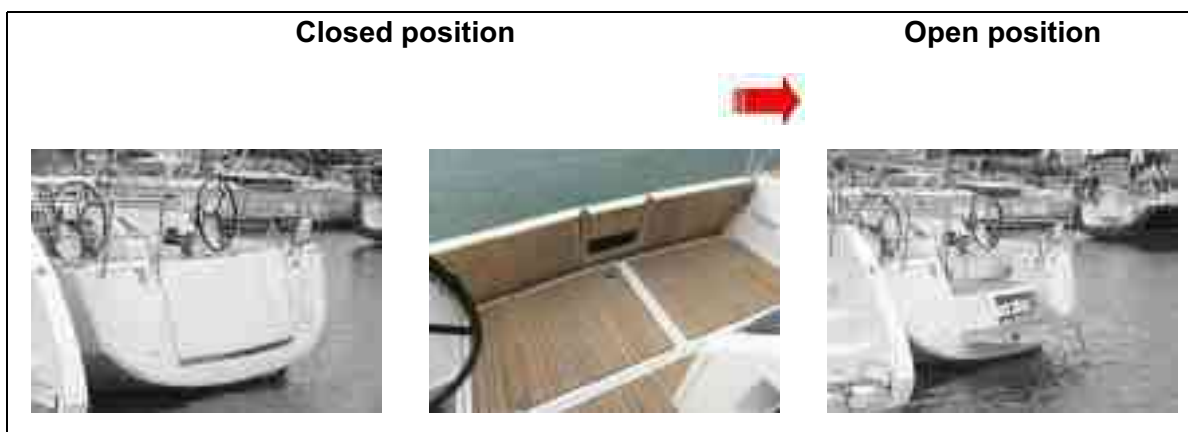

Locking system



**NOTE: The platform must remain closed when the boat is under way.**

Platform raise / lower control



Box

Location: Cockpit locker  
Access by the aft starboard cabin



Remote control





- Do not climb onto the platform while in motion.



- Do not use the rear platform while sailing.
- Maximum platform load = 300 Kg. (Load must be uniformly distributed).
- During platform opening or closure:
  - Beware of the system movements to avoid injuries.
  - Never leave children unattended when they are using the system.



- When you are using the platform remote control, check beforehand that the space in which it operates is completely clear of obstructions and remains so throughout the operation.



- Do not let a child operate the platform remote control on his/her own.

### ADVICE-RECOMMENDATION

- When not operating:
  - Make sure the breaker is turned off.
  - In upper position: Make sure the locking mechanism is properly locked.

---

## emergency procedure

If the cylinder fails, you can close the platform manually by following the stages below:

- Shut off the DC supply of the cylinder by the circuit breaker;
- Remove the split ring and the shaft at the two cylinder fixings;
- Remove the platform cylinder and store it in the boat;
- Strike an end on the platform to raise it manually. It is possible to use a winch for this operation

Piston  
Location: Liferaft locker



"Deck" side cylinder end



"Platform" side cylinder end





### 16.2.2 Davits

- The davits enable the launch and retrieval of the tender from the transom. Any other use is dangerous and forbidden.
- The davits are equipped with a pulley block for manoeuvring the tender. This pulley block is manoeuvred by hand..

Layout of components:



#### Launching the tender

- Put the bung in.
- Secure the pulley's hooks to the front and back of the tender.
- Raise the front and then the back of the tender alternately as high as the pulley block allows.

#### Retrieving the tender from the water

- Pull out the bung.
- Secure the pulley's hooks to the front and back of the tender.
- Lower the front then the back of the tender alternately until it touches the water.



No one is to be onboard the tender while launching or retrieving it.



The davits are designed to support a maximum load of 110 kg and a tender which is maximum 3,20 metres long.

### **ADVICE-RECOMMENDATION**

- Before heading out to sea, remove the outboard engine from the tender and store it on the boat.
- Secure the tender taking account of sea conditions.
- Secure the outboard engine to the tender once this is in the water.



## 16.3 BERTHING, ANCHORING, TOWING

### 16.3.1 Anchor points

#### **Responsibility**

It is the responsibility of the owner/user of the boat to ensure that the berthing lines, towing cables, chains and mooring lines and the anchors are adequate for the intended use of the boat, i.e. that the lines or chains do not exceed 80 % of the breaking strength of the corresponding anchor point.

	MOORING LINES	MOORING	TOWING
Reference <i>(Diagram on next page)</i>	<b>A &amp; B</b>	<b>B</b>	<b>B</b>
Anchor Point Breaking Strength	<b>33,2 kN</b>	<b>47,6 kN</b>	<b>47,6 kN</b>
Mooring Line/Chain Breaking Strength	<b>26,5 kN</b>	<b>38,1 kN</b>	<b>38,1 kN</b>



The anchoring points or those showing visible signs of deterioration must be replaced.

**Pass warps through the fairleads provided for this purpose.**

### 16.3.2 Towing

Responsibility: It is important that the owner thinks through the actions required when securing a towing cable onboard.

#### Location of attachment points



A. Mooring cleats (which correspond to the anchor points for the lifelines).

B. Towing:

- at the bow, to be towed
- at the stern, to tow

- Generally the breaking strength of lines/chains must not exceed 80% of the breaking strength of the anchor points.

- Always tow or be towed at low speed. Never exceed the maximum speed of a displacement hull during a tow.



- Be particularly vigilant when the end of a towing cable is being thrown or received (risk of the end becoming caught in the propeller).

- A towing cable must always be secured in such a way that it can be released under load.

- Do not try to stop the boat by using a boathook or your foot, hand or any other part of your body.

## 16.4 MAIN ELEMENTS OF THE CHAIN LOCKER

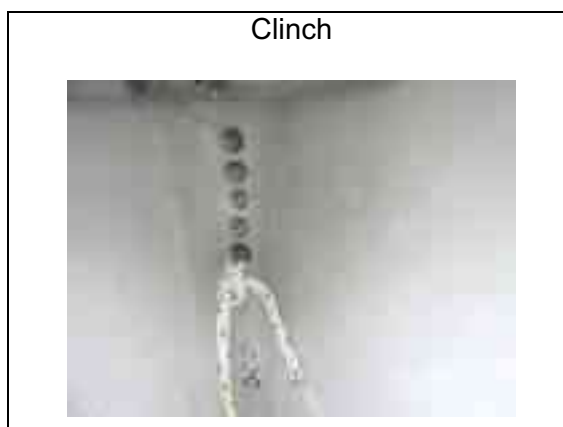
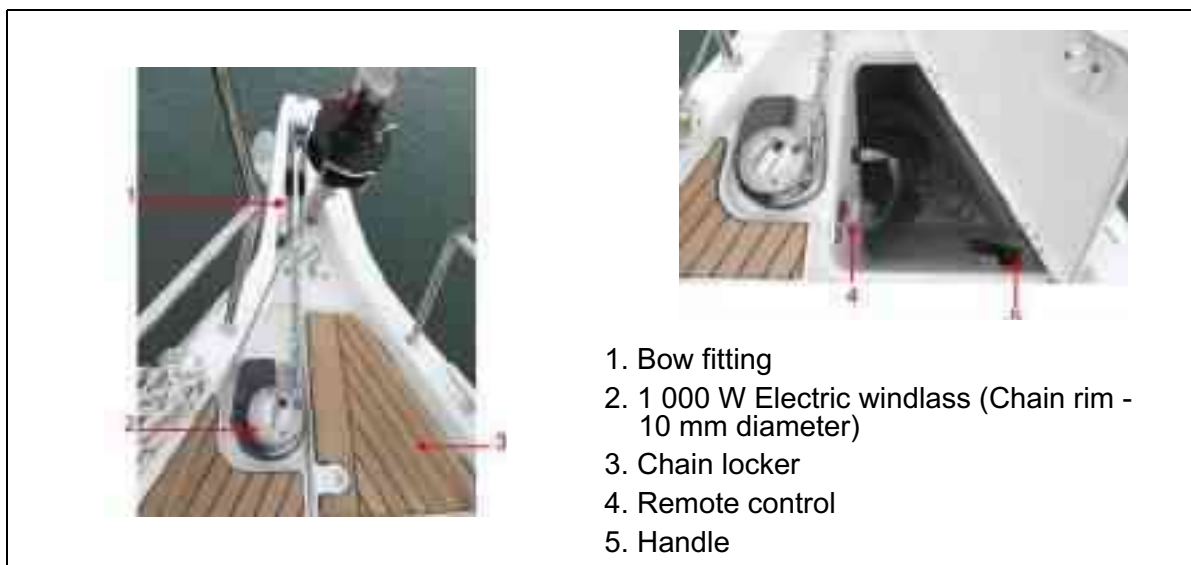

Refer to the manufacturer's instructions for use and maintenance.



Windlass operations are dangerous:

- Always keep the anchor chain or rode free and unfouled;
- Carry out manoeuvres carefully and always wear shoes;
- Avoid wearing baggy clothing, long hair that's loose and jewellery that could get caught in the engine when it is running.

---

## 16.5 ELECTRIC WINDLASS

### General points

- The windlass is DC powered.
- The windlass is designed for anchoring purposes: Any other use is dangerous and forbidden.
- An operation relay is fitted to the electrical circuit.
- A circuit-breaker protects the power supply to the windlass.
- The windlass operation is activated by an operational interlock relay which is powered by the engine's alternator: the windlass only works when the boat's engine is running.
- The controls to raise/lower the windlass are protected by a circuit-breaker positioned between the batteries and the windlass relay.
- Your boat may be equipped with a chain meter: this shows the length of chain let out.

### **ADVICE-RECOMMENDATION**

Refer to the manufacturer's instructions for use and maintenance.

### Operation

- Before lowering the anchor, make sure that the chain or anchor rode is securely attached to the clinch.
- Activate the circuit-breaker then use the control to start the windlass.
- **When at sea, secure the chain or anchor rode to secure points such as the chain stopper or the anchor rode to the belaying cleat (the windlass must not be used as the only method of securing the chain or rode).**
- In the case of dual control, be careful to use just one control at a time.
- When raising the anchor, use the boat's engine to move towards the position of the anchor, until the boat is just over it: never use the windlass as a winch to move the boat forward.
- When out at sea, cut the electrical supply to the windlass.
- Cut the electrical supply when using the windlass manually.

Operation relay (located inside the box)  
Location: Sail locker





### Maintenance

- once a year, dismantle, carefully wash and grease all the moving parts of the windlass.
- Regularly grease the supply terminals of the electric motor of the windlass and of the relay control box.

### Emergency anchoring procedure

In the event of an electrical fault, it is possible to lower the anchor manually: Put the handle in the space provided for this to release the chain grab. Then let the chain run out using the handle to control its speed as it runs.



The handle serves only to release the chain grab in order to lower the anchor manually should the electric windlass break down. The handle cannot be used to raise the anchor manually.

### **ADVICE-RECOMMENDATION**

- Before anchoring check the depth of water, the power of the current and the nature of the sea bed.
- Check the swinging area once the boat is at anchor.
- After each trip rinse the windlass and anchor chain or rode with fresh water.

## Layout diagram - Chain meter

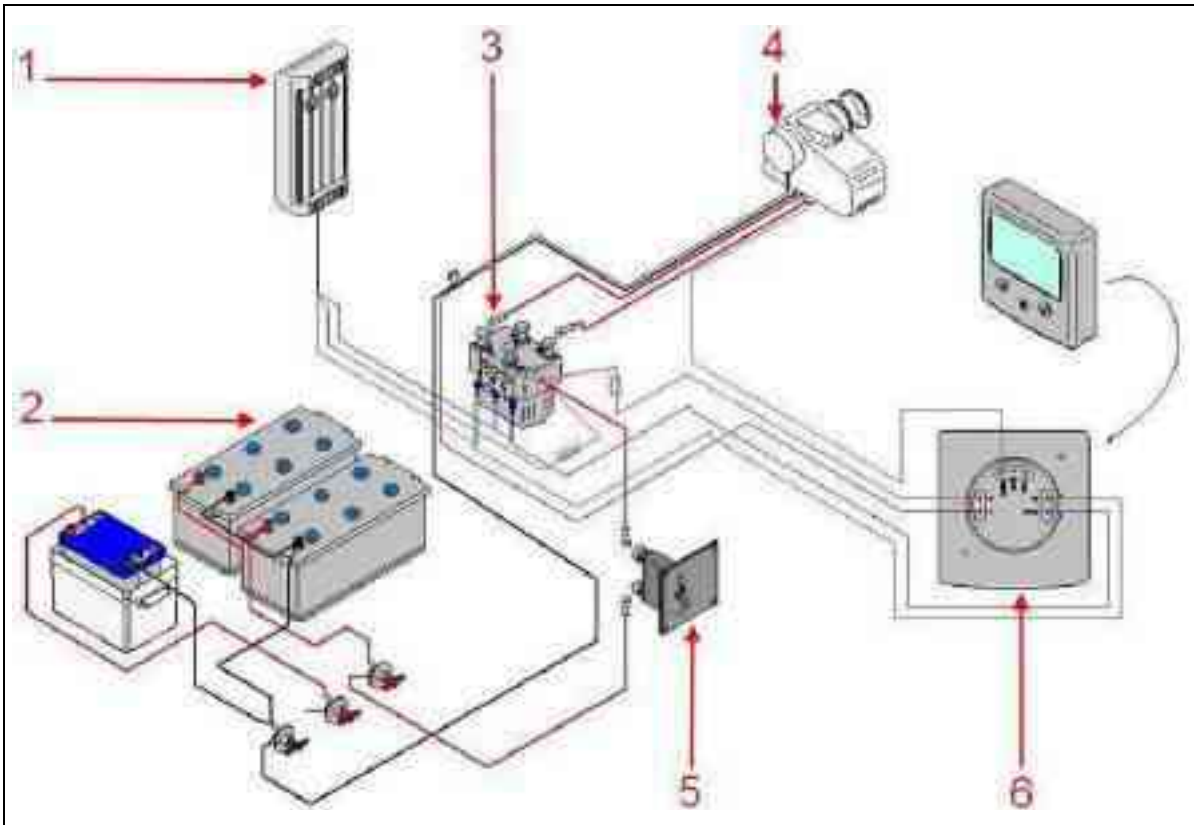

Reference	Designation
1	Remote control for the windlass
2	Service batteries
3	Operation relay
4	Windlass
5	Breaker
6	Chain meter

Chain counter control  
Location: Steering station (Starboard)







## 17 HULL FITTINGS

### 17.1 UPHOLSTERY

#### LEATHER

##### Maintenance

Leather must be regularly cleaned and waxed.

To do so, clean the leather surface with a damp rag. This operation will remove dust.

Every 6 months to a year depending on use, apply a leather shampoo on the leather then use a hydrating cream which will also protect it.

##### Stain removal

If the leather surface gets stained, clean immediately using an absorbent piece of paper. Do not scour. Clean inwards to prevent the stain from spreading.

- Buffer applying denatured alcohol with a piece of cotton (ink and food stains).
- Apply absorbent powder (talcum) on grease stains.

Wait a couple of hours, then brush the excess of powder.

- Other: Apply white vinegar or acetic acid diluted in water.

#### **ADVICE-RECOMMENDATION**

- Test the product on a small hidden area of the surface before cleaning.
- Avoid excessive moisture.
- Do not scrub on leather surfaces.
- If you notice leather colour on the rag, immediately stop cleaning.

---

## **ALCANTARA (microfibre)**

### Stain removal

The fabric must be free from dust before removing. To do so, use a vacuum cleaner to achieve optimal cleanness.

Rub with a duster soaked in a solution containing ammonia diluted by 10%. Dilute to the strength appropriate for this fabric. Try it out first on a hidden corner, the hem for instance, if the appearance of the fabric changes, dilute accordingly.

Scrub the Alcantara fabric in all directions, particularly on the stains.

Rinse off the cleaning solution using a damp cloth.

Dry in the open air.

After taking the Alcantara fabric off, it's a good idea to use a soft brush on it to bring back its supersoft quality.

For difficult stains, dry-cleaning is recommended.

## **SYNTHETIC FABRIC**

### Stain removal

If you can remove the fabric:

- Clean in the washing machine (use the program for delicate fabric) at 30°.
- Do not iron.
- Never use Javel water.
- Do not dry-clean.
- Do not use a clothes drier.

If you cannot remove the fabric:

- Clean with the vacuum cleaner,
- Clean with a foam for synthetic fabrics (see foam use instructions).



## COATED FABRIC (PVC)

### Maintenance

- The PVC must be regularly cleaned with soapy water to maintain its appearance and avoid accumulation of debris. Try to avoid using the following products: lacqueurs, aggressive cleaning products, detergents, xylene or acetone-based products which can cause permanent damage or make the fabric deteriorate. The use of such products is at the owner's risk.

### Stain removal

- All stains must be quickly removed to avoid formation of permanent stains.
- Use mild water to remove the stains found on the fabric surface. Use only clean, white, damp pieces of cloth.
- Difficult stains can be removed using a mixture of water (25%) and white spirit.
- Rinse with clean water.
- Dry with a soft piece of cloth.

## ACRYLIC (bimini fabric type)

### Maintenance

To maintain the quality of the fabric, you are advised to spray it regularly with clarified water and to brush it with a soft brush (brush for clothes). It is advisable to clean thoroughly every 2 years.

### Stain removal

Follow these steps for routine cleaning:

- Remove as much debris as possible using a soft brush;
- Spray the fabric with water;
- Prepare a cleaning solution using mild soap and water (Do not use detergent);
- Wash with a soft brush;
- Wait for soapy solution to act;
- Rinse thoroughly in fresh water;
- Dry in the open air.

---

## 17.2 INTERIOR WOODWORK

### Varnished wooden panels:

#### **The UV varnish used has a matt appearance:**

- The acrylic varnish features medium resistance to external chemical damage as well as minor scratches.
- Clean regularly with lukewarm soapy water.
- Do not use polish (risk of causing a brighter appearance).
- For scratches, remove the panel and have it re-varnished by your dealer.

#### **The acrylic varnish used has a very matt appearance:**

- The acrylic varnish features medium resistance to external chemical damage as well as minor scratches.
- The varnished surface tends to get dirty quickly since it is not flat and reveals hollow pores.  
*NOTE: Vigorously rubbing a varnish surface gives it a brighter appearance.*
- Do not use polish (risk of causing a brighter appearance).
- Gently and regularly clean with lukewarm soapy water.
- For scratches, remove the panel and have it re-varnished by your dealer.

### Floors:

- The floors fitted onboard are laminated.
- Clean regularly with lukewarm soapy water.
- For scratches, remove the plank and replace it with a new one (consult your dealer).



### 17.3 INTERIOR MAINTENANCE

- Take advantage of fine weather to air the interior upholstery.
- Remove the cushions during lengthy periods of absence.
- Make sure the bilges are clean and dry.
- For lengthy periods of absence, leave the icebox and fridge doors open to prevent mould from developing.
- Use a dehumidifier in the saloon and ensure cabin and storage doors are left open (cupboards, iceboxes...).

#### ADVICE-RECOMMENDATION

If the stains persist or if in doubt, consult a cleaning specialist.

For wintering, ensure the curtains are drawn to prevent prolonged exposure of the varnish and the fabric to sunlight (risk of discolouration).

NEVER:

- Use solvents or abrasive products;
- Use a heat source (hairdryer/clothes dryer);
- Use detergent, silicone, acetone, chlorine-based products or hot water;
- Use a high pressure cleaner.



## 18 HANDLING, TRANSPORT

### 18.1 LIFTING PLAN

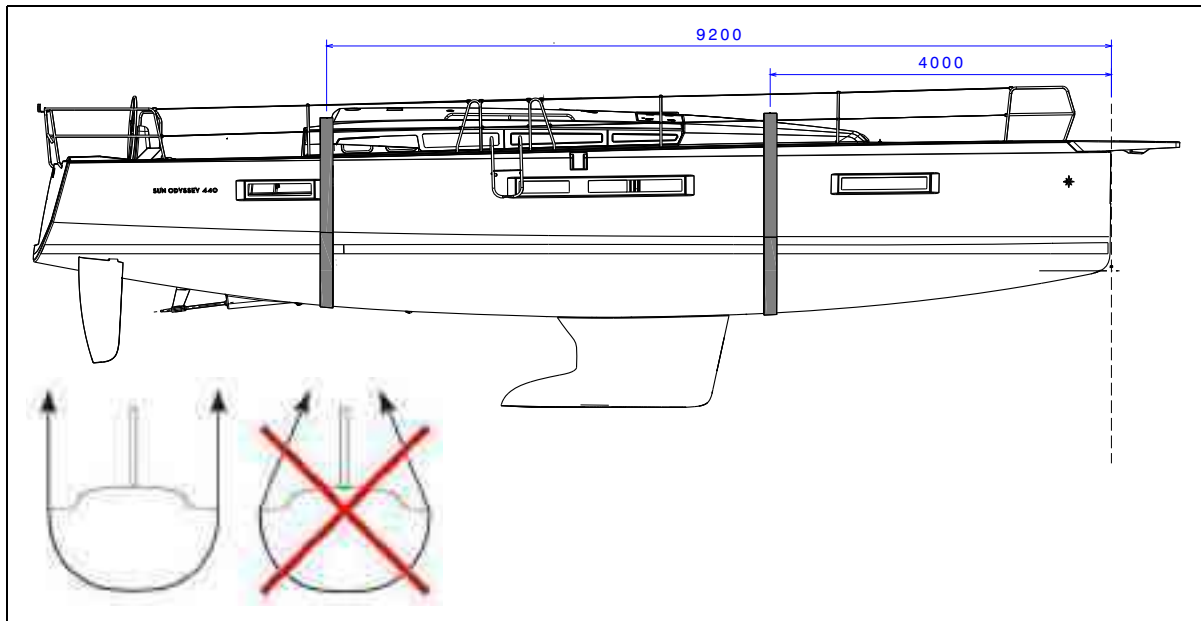

HANDLING, TRANSPORT

*Note: Measurements are expressed in mm.*

The position of the lifting slings is shown in the pictogram below:

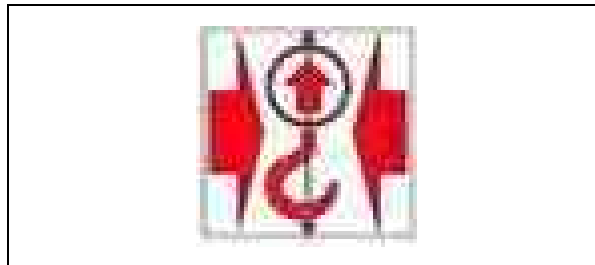

---

## 18.2 LIFTING

- Before the first application of antifouling to the hull, you can lightly sand the hull using 400 µm or more wet and dry sandpaper.
- The lower hull of your boat should be covered with an anti-fouling paint which will prevent the adhesion of marine growth.
- The nature of the water where you keep your boat and the frequency of lifting it out determines the choice of antifouling.
- All bronze or steel surfaces, including the propellers, should be protected by a suitable antifoul paint.
- During lift-outs, check the anodes, cutlass bearing and propeller (see corresponding chapters).
- Antifouling can deteriorate when the boat is ashore or dried out: Please observe the time limit out of water set by the supplier.

Before applying the antifoul NEVER:

- Do any sandblasting;
- Use any other solvents than ethylic alcohol;
- Use detergents under pressure;
- Use scrapers;
- Use grinding tools.

If cleaning off existing antifouling requires high pressure washing:

- Ensure the water temperature does not exceed 15 degrees;
- The water pressure must not exceed 150 bars (2175 PSI);
- The distance between the hose nozzle and the hull must not be less than 10 centimetres.

The wet surface area of the boat is about: 49 m<sup>2</sup>.



- Follow the manufacturer's recommendations scrupulously when applying antifouling.
- Never cover with antifouling:
  - the anodes;
  - the earthing plates (Generator / DC/AC converter);
  - the sensors of the electronic instruments.
- Avoid using copper or tin-based antifouling: these are banned in some countries.



## 18.3 KEEL

### General points

The ballast is the appendix located under a sailing yacht. It is an essential component of stability, essential for the operation of the boat.

The ballast is fixed to the bottom of the hull by bolts or pins and nuts with the corresponding tightening torque.

### Maintenance

The ballast is a part of the hull under the waterline. It needs to be protected with anti-fouling paint.

Each time the hull is cleaned and each year at least, inspect the condition of the ballast visually together with its joint with the hull. Any fault, crack or burst must be reported to your dealer or a professional who will give you the right advice.

### Yearly inspection

Make a visual inspection of all the ballast fixings under the floors. Make sure there are no cracks around the washers, bolts or nuts and that there is no significant corrosion. Any work carried out on these components must be done professionally.

### In the event of an incident

In the event of grounding or impact with an unidentified floating object, lift the floors and check that there is no leakage of seawater in the ballast area. Do the same in the area of the rudder mountings.

If there is a leak of seawater, even small, reduce speed and contact the emergency services to follow their advice.

Then take the boat out of the water immediately and have it professionally inspected.

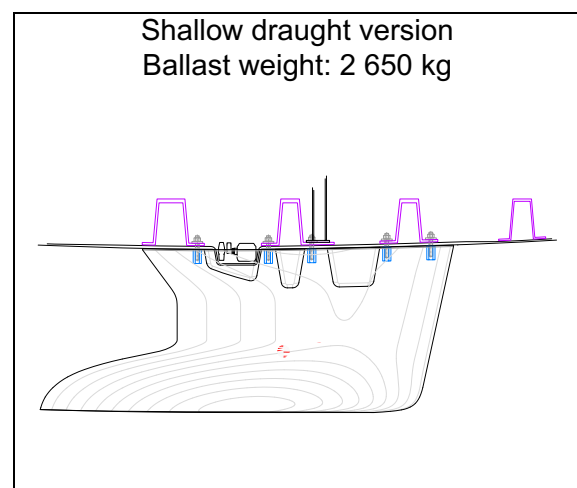
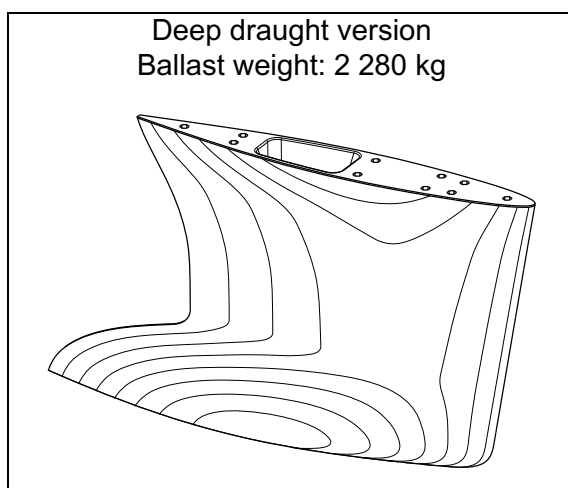

---

## 18.4 UPPER LIMIT OF ANTIFOUL

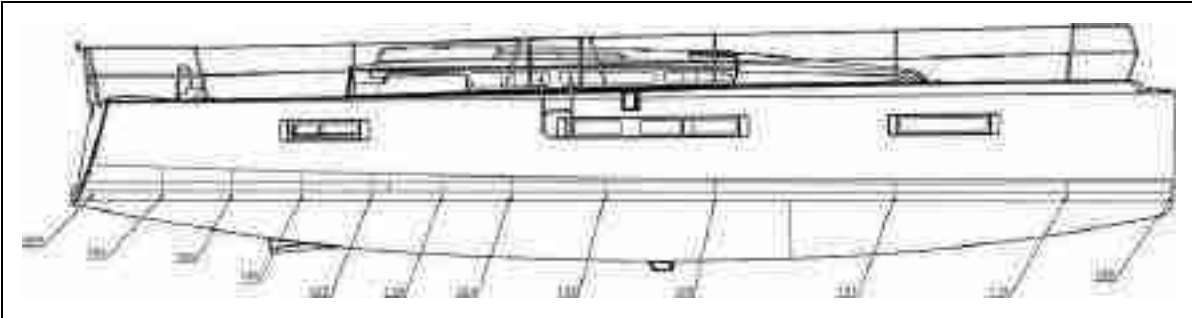

*Note: Measurements are expressed in mm.*

## 18.5 LAUNCH/LIFT OUT

The initial commissioning of your boat will require a lot of skill and care. The proper working of all your boat's equipment is the result of the quality of the commissioning operations. This is why the initial launch must be overseen by your dealer.

### Before launching

- Replace the log in its housing.
- Check the cleanliness of the sea water strainers.
- Check the anodes (see Chapter: ELECTRICAL SYSTEM).
- Check the propeller/hydrolube bush (see Chapter: STEERING SYSTEM).
- Prepare enough fenders and lines.
- Check the engine's sea water intake valve and the fuel feed valve (see Chapter: ENGINE).

## 18.6 STEPPING/UNSTEPPING THE MAST

The stepping /unstepping operations require the skills of a professional rigger: please consult your dealer.



Do not remain onboard or beneath the boat during the handling operations.



- When placing the slings make sure that the positioning marks are still visible.
- Submerge the sling fully under the engine mounting.



## 18.7 WINTER STORAGE

- Take advantage of laying up the boat to carry out a full inventory of the equipment.
- Check the expiry dates of the safety equipment.
- Have the liferaft overhauled.
- Empty the complete water system inside and outside and rinse it through with a mix of water and vinegar (do not use a chlorinated product).
- Empty and rinse the complete black water system.
- Dry out and clean the boat's bilges.
- Grease and close all the valves and through-hull fittings.
- Close all the boat's seacocks.
- Remove the depth sounder and log sensors.
- Put the covers back on the electronic screens.
- Use a dehumidifier in the saloon and ensure cabin and storage doors are left open.
- Air all of the cushions and upholstery for a good while before putting them back onboard and arranging them so as to limit the surface areas touching.
- Close the blackout curtains.
- Leave open the fridge/icebox doors to prevent mould and smells from developing.
- Protect the boat as well as possible with fenders.
- Make sure the boat is properly moored.
- Grease all mechanical and moving parts (bolts, hinges, locks...).
- Remove the sails and store them somewhere dry and well-ventilated.
- Remove the movable upholstery.
- Disconnect the batteries. Make sure you recharge them during the winter period if the boat is left inactive for too long.

### ADVICE-RECOMMENDATION

- The winterisation of the engine requires the skills of a professional engineer: please consult your dealer.
- This is not an exhaustive list of recommendations: Your dealer will give you the advice you need and will carry out the technical maintenance of your boat.

## 18.8 TRANSPORT

### Packing plan

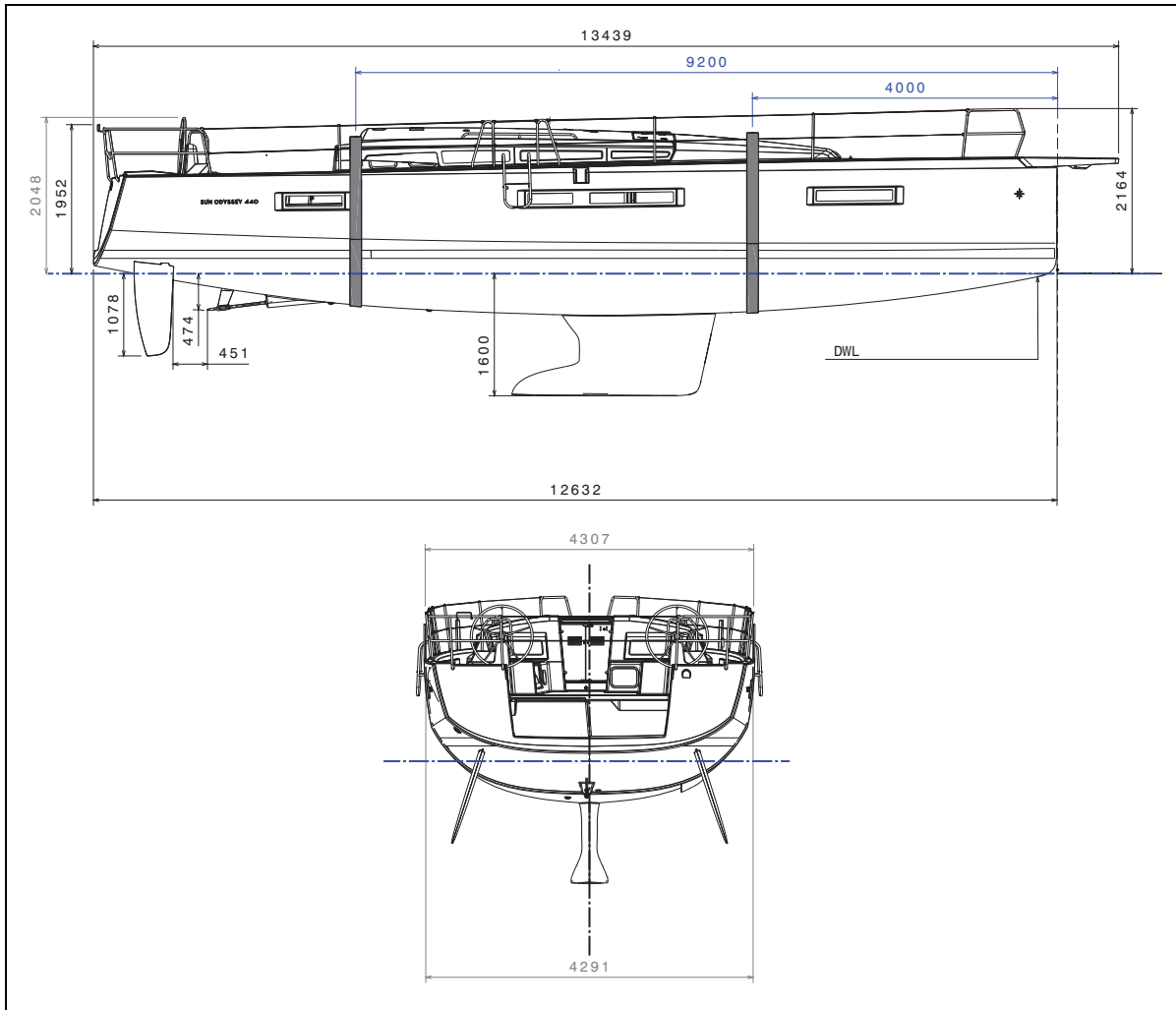

*Note: Measurements are expressed in mm.*



## 19 ENVIRONMENT

### Waste management:

- Throw all packaging in the recycling containers provided for this.
- Once a piece of equipment has completely stopped working, find out about the relevant recycling regulations from your nearest recycling centre or from your dealer.
- Make sure you follow the relevant local laws when you scrap it.
- Some onboard equipment can have a toxic effect on the environment and on human health, caused by the specific substances they contain: Do not throw any equipment in household waste containers and absolutely not in the sea.
- Dead batteries are toxic to health and to the environment. So, batteries must not be put in with household waste, but must be recycled separately. Contact the harbour master or a specialist company about recycling them.









- Make sure you know the local environmental regulations and follow the codes of best practice.
- Do not pump out the toilets or the contents of the black water tank near the coast or in areas where it's forbidden. Use the pump-out facilities available in ports or marinas to empty the contents of the black water tank before leaving port.
- Make sure you know the international regulations to prevent pollution in the marine environment (Convention MARPOL) and follow these as much as possible.





## APPENDIXE: MEANING OF THE LABELS

					
Engine group	Plumbing group	Colour - WC group	General electrical equipment	Comfort group	Drainage group



Valve location label

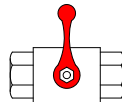



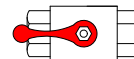





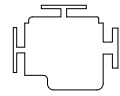

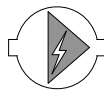
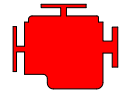

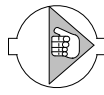
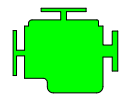





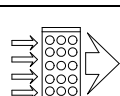

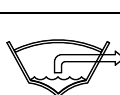

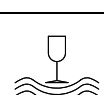
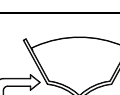

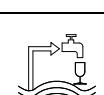

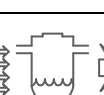
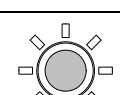
Closed valve



Open valve

### Meaning of the symbols

	Motor		Shower		Electric pump
	Port engine		Washbasin		Manual pump
	Starboard engine		Icemaker		WC Toilet
	Propeller shaft		Deck wash		Washer
	Filter		Sea water tap		Dryer
	Hull drainage		Waste water tank		Dishwasher
	Sea water intake		Fresh water tank		Water maker
	Shore power socket		Fuel tank		Fuel filter
	Service		WC Holding tank		Inverter
	Generator		12V Battery stock		Heating
	Breaker		Thruster		Air conditioning

---

Each label is defined by:  
a functional group (specific colour);  
example:

