

# SUN ODYSSEY 49 DS



## OWNER'S MANUAL



**JEANNEAU**

**CROISIÈRE**

<https://www.boat-manuals.com/>



# CONTENTS

SUN ODYSSEY 49 DS Anglais  
Update 06/2004  
Index 1

Code: 981729

Total number of pages: 134

## **INTRODUCTION**

## **HISTORY OF UPDATES**

**Chapter 1..... Page 5**

## **SPECIFICATIONS AND WARRANTY**

**Chapter 2..... Page 13**

## **SAFETY**

**Chapter 3..... Page 27**

## **HULL**

**Chapter 4..... Page 37**

## **DECK**

**Chapter 5..... Page 49**

## **RIGGING AND SAILS**

**Chapter 6..... Page 71**

## **ACCOMMODATIONS**

**Chapter 7..... Page 81**

## **PLUMBING**

**Chapter 8..... Page 95**

## **ELECTRIC SYSTEMS**

Drawings at the end of the manual

**Chapter 9..... Page 105**

## **DIESEL ENGINE**

**Chapter 10..... Page 121**

## **LAUNCHING**

**Chapter 11..... Page 127**

## **WINTER STORAGE**

## **PERSONAL NOTES**

At the end of the manual

## **APPENDIX AND OPTIONAL EXTRAS**

At the end of the manual

# HISTORY OF UPDATES

- Index 0.....1/03/2004
- Index 1..... Page 72.....22/11/2004

# INTRODUCTION

We share a common passion for the sea: we, JEANNEAU as shipbuilders and you who want to live your passion on the Seven Seas.

We are delighted to welcome you to the great family of JEANNEAU boat owners and we congratulate you on it.

This manual was meant to help you to enjoy your boat comfortably and safely. It includes the boat specifications, the equipment provided or installed, the systems and tips on her operation and maintenance.

Read this manual carefully before you put out to sea so that you can make the most of her and avoid any damage and any trouble. Get to know your boat before you sail.

We keep improving our boats as we want you to benefit from the technological developments, new equipment or materials and our own experience. That is the reason why the specifications and information given are not contractual, they may be modified without prior notice or up dates.

This owner's manual is designed in accordance with the ISO 10 240 standard requirements, it has a general purpose and it may sometimes list some equipment or accessories or deal with some points or questions that are not relevant to your own boat. In case of doubt refer to the inventory list you were given when you bought your boat.

Our network of JEANNEAU authorized dealers will be at your disposal to help you get acquainted with your boat and will be the most qualified to take care of her maintenance.

If this is your first boat or if you change to a new type of boat which you are not used to, get some training in boat control and sailing to ensure your safety and comfort. Your dealer, your international sailing association or your yacht club will be very happy to recommend local sailing schools or professional instructors.

Even if everything has been provided for and designed for the safety of the boat and the safety of her users, don't forget that sailing highly depends on the weather conditions, the sea condition, and that only an experienced and very fit crew, handling a well-maintained boat can sail satisfactorily.

The sea and wind conditions that correspond to the design categories A, B or C are changeable and are dependent on the hazards of unusually strong waves or gusty winds. Therefore total safety cannot be guaranteed, even if your boat meets the requirements of a category.

Always listen to the weather forecast before you put out to sea.

Make sure the sea and wind conditions will correspond to the category of your boat and you and your crew are able to handle the boat in these conditions.

The sea and the water are not the natural environment of Man and one has to respect their laws and strength.

Adapt the use of your boat to her condition that wears out with time and use.

Any boat, however solid she may be, may be severely damaged if badly used. This is not compatible with a secure navigation. Always adapt the speed and direction of your boat to the conditions of the sea.

The 'COLREG', an international regulation in order to prevent collision at sea, published by the International Maritime Organization, specifies the steering and course regulations, the navigation lights etc. throughout the world. Make sure you know these regulations and you have on board a manual that explains them.

In numerous countries, a licence, an authorization or a training course is requested. Make sure you have this legal authorization before you use your boat.

Always use an experienced technician for the maintenance of your boat, the fitting of accessories and the carrying out of small modifications. The written authorization of the builder or his legal representative is compulsory for modifications that alter the specifications of the boat, in particular the vertical layout of the grounds (putting up of a radar, modification of the mast, change of the engine etc.).

For the essential or optional equipment (engine, electronics etc.) refer to their respective manual delivered with your boat.

The users of the boat are informed of the following:

- The entire crew must be trained properly.
- The boat shall not be loaded more with than the maximum load recommended by the builder, in particular the total weight of the food supplies, of the different equipment that are not supplied by the builder and of the persons on board. The weight of the boat shall be properly distributed.
- The water in the bilge shall be kept at its minimum.
- The stability is reduced when you add weight in the upper parts.
- In case of heavy weather, the hatches, lockers and doors shall be closed in order to minimize the risk of water coming in.
- The stability may be reduced when you tow a boat or when you lift heavy weights with the davits or the boom.
- Breakers are serious dangers to stability.
- If your boat is equipped with a liferaft, carefully read the instructions. In the boat there shall be all the proper safety equipment (harness, flares, liferaft etc.) depending on the type of boat, the country, the weather
- The crew must be familiar with the use of all the safety equipment and the emergency safety procedures (MOB, towing etc.).
- Anyone on the deck shall wear a life jacket or a buoyancy aid. Please note that in some countries it is compulsory to wear an homologated buoyancy aid permanently.
- A part of the data is shown on the builder's plate fixed to the boat. The explanation of these data is given in the appropriate chapters of this manual.

Keep this manual in a safe place and hand it over to the new owner if you sell your boat.







# **SPECIFICATIONS AND WARRANTY**

***YOUR BOAT***

---

***TERMS AND CONDITIONS OF WARRANTY***

---

## SPECIFICATIONS

L.O.A.....	14,98 m/49' 2"
Length of hull.....	14,73 m/48' 4"
L.W.L.....	12,90 m/42' 4"
Max. beam .....	4,49 m/14' 9"
Waterline beam .....	3,80 m/12' 6"
Ballast weight Deep keel.....	3 750 kg/8 267 lbs
Draft Deep keel .....	2,15 m/7' 1"
Ballast weight Shallow keel .....	4 100 kg/9 039 lbs
Draft Shallow keel .....	1,65 m/5' 5"
Light displacement - Deep keel.....	12 600 kg/27 778 lbs
Light displacement - Shallow keel.....	13 000 kg/28 660 lbs
Maximum load displacement - deep keel.....	17 600 kg/38 801 lbs
Maximum load displacement - shallow keel.....	18 000 kg/39 683 lbs
Water tank capacity .....	700 l/185 US gal
Fuel oil tank capacity.....	240 l/63 US gal
Refrigeration unit capacity .....	230 l/61 US gal
Recommended engine power (diesel engine).....	75 HP (56 kW)
Battery capacity .....	2 x 55 Amph +4 x 80 Amph (12 V)
Cabins.....	3
Berths .....	6 (+ 2 in option)

CE Category	2,3,4 cabins	Maximum load
A	10 persons	
B	12 persons	3 477 kg/7 665 lbs
C	14 persons	3 677 kg/8 106 lbs

Maximum load including the mass of the persons who are authorized on board (75 kg/165 lbs per adult), the supplies, the liquids that can be used (fresh water and fuel) in fixed completely full tanks, the additional loads, the optional equipments, the liferaft and the scope for load.

Architect..... Philippe BRIAND, Jeanneau Design

### SAILS

Fully battened main (Optional extra) .....	47,6 m <sup>2</sup> /511 sq.ft
Furling mainsail.....	37,5 m <sup>2</sup> /404 sq.ft
Furling genoa.....	59,5 m <sup>2</sup> /640 sq.ft
Spinnaker .....	130 m <sup>2</sup> /1 399 sq.ft
I .....	17 m/55' 9"
J .....	5,68 m/18' 8"
P .....	15,75 m/51' 8"
E.....	5,40 m/17'8,5"

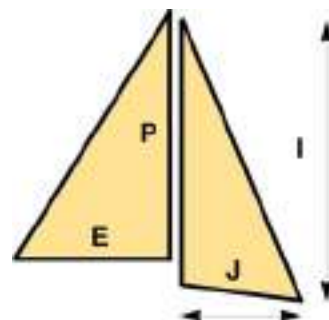

The sails are the main propulsion means of the SUN ODYSSEY 49 DS.



### **Category A 'In the open sea'**

This boat is designed for sailing in winds that may exceed force 8 on the Beaufort scale and in waves of a significant height of 4 m and more, and the boat is to a large extent self-sufficient. Unusual conditions such as hurricanes are excluded. You may meet with such conditions when you sail long crossings, for instance across the oceans, or close to the shore, when you are not protected from the wind or waves over several hundreds of nautical miles.

The significant height of a wave is the average height of the upper third of the waves, that approximately corresponds to the height of a wave an experienced observer can assess. Some waves will be twice as high as this value.

The conformity of the SUN ODYSSEY 49 DS model to the 94/25/CE directive is attested by Bureau Veritas.

## YOUR BOAT

**Version** .....

NAME OF THE BOAT .....

NAME OF THE OWNER .....

ADDRESS .....

.....

.....

.....

HULL NUMBER .....

SERIAL NUMBER .....

REGISTRATION NUMBER .....

DELIVERY DATE .....

DOOR KEY NUMBER .....

MAKE OF ENGINE .....

ENGINE SERIAL NUMBER .....

ENGINE KEY NUMBER .....

Your agent



CHANTIERS JEANNEAU - BP 529 - 85505 LES HERBIERS cedex - FRANCE  
Tel. (33) 02 51 64 20 20 - Fax (33) 02 51 67 37 65  
Internet : [http://www.jeanneau.com\(fr\)](http://www.jeanneau.com(fr)).





## TERMS AND CONDITIONS OF WARRANTY

### Article 1

At the time of delivery of the boat the parties sign the Certificate of Delivery supplied by CHANTIERS JEANNEAU for this purpose and this is equivalent to an agreement of compliance by the purchaser-user.

The acceptance of delivery of the boat by the purchaser-user without reserve is equivalent to the acceptance of the apparent condition of the boat in pursuance of the provisions of Section 1642 of the Civil Code.

The terms of warranty are engaged only upon:

- the return to the After Sales Department in CHANTIERS JEANNEAU of the duly filled in tear-away section of the Certificate of Delivery and of the Warranty Registration Card,
- the carrying out of the controls and service set forth by CHANTIERS JEANNEAU, being made clear that the possible expenses of handling, transportation, parking, escorting which have been incurred in the execution of the above mentioned directives are born exclusively by the purchaser-user.

### Article 2

The warranty is valid for a duration of 12 months from the date of delivery of the boat to the first purchaser-user and it is strictly limited as the manufacturer chooses, to the replacement or free repair of any part that has been found defective by the technical specialists of the latter and no compensation whatsoever shall be paid in this respect.

As for components and accessories which visibly bear the trademark of another supplier, the warranty shall be limited to the warranty provided by said supplier.

### Article 3

With the exception of any prototype boats, RIGIFLEX boats, boats used for business purposes, or boats specifically designed and/or equipped for racing, which have as a contractual warranty only that indicated in article 2 above, the structure of the hull, the deck and the hull to deck joint and the hull to keel joint is warranted against all manufacturing defects identified by the technical specialists of CHANTIERS JEANNEAU, for a period of 5 years for monohull boats and 3 years for motor boats and multihull boats.

However, any incident that affects the structure and does not result from a manufacturing defect covered under the conditions of warranty, that would have resulted or not in the repair of the deck or hull, shall effectively cancel all terms and conditions of warranty and without prejudice immediately.

The warranty period starts from the date of the first commissioning of the boat and at the latest from the last day of the model year in which the boat was built, i.e. August 31 of the said year.

This warranty is strictly limited to the free repair of the manufacturing defects either in our yard or by a repair shop or shipyard we authorized and no compensation whatsoever shall be paid in this respect.

---

#### **Article 4**

The following items are excluded from the terms of warranty as stated in articles 1 and 2 above:

- The transport and carriage expenses for the boat and parts as well as expenses and/or possible losses resulting from the inability to use the boat and/or accessories, shall be born by the purchaser,
- The deterioration or damages hereinafter listed as well as their consequences:
  - Normal wear and tear,
  - Cracks, cracking or fading of the gel coat,
  - Damages resulting from:
    - changes and modifications or repairs, even partial, performed in workshops different from those authorized by our company,
    - the failure to follow the recommended maintenance procedures stated in the owner's manual delivered with the boat, or failure to follow the professional procedure,
    - improper use, in particular careless use, or rash use, misuse or abnormal use,
    - the participation in competitive events,
    - acts of negligence as regards to the necessity to take the necessary measures of conservation,
    - an accident or catastrophe such as explosion, fire, flood, storm, lightning, transport, riot, theft, collision,
    - unsuitable storage or transport conditions.

#### **Article 5**

The bringing into play of the warranty shall extend the period of warranty for a period equal to the one that is necessary to carry out the repair work under the warranty, on the condition that the afore-mentioned repair work requires an immobilization of the boat for minimum 7 consecutive days.

#### **Article 6**

In order to enjoy the above-specified warranty, the purchaser-user shall present the duly filled in Certificate of Delivery and Warranty document each time a claim is presented and in a written, precise and justified document he shall notify his authorized dealer-seller the defect or fault within 15 days from the day when the defect or fault is discovered otherwise he will not enjoy this warranty.

The authorized dealer-seller shall inform the builder about the purchaser-user's claim within a period of 8 days from its receipt otherwise he shall have to bear the consequences resulting from his delay.



### Article 7

The authorized dealers, agents or sellers of CHANTIERS JEANNEAU do not have the authority to alter the above warranty but, on their own account and in their own responsibility, they may grant possible additional warranties which can bind the builder under no circumstances.

### PRECAUTION BEFORE ANY REPAIR

Contact your seller who will give you the best advice and the suitable parts or materials for the repairs you can carry out yourself.

It would be better to have important repairs of the hull or engine done by a professional. Your seller can carry out these repairs or appoint a skilled person to carry them out.



### DANGER

Contact your seller to find out what is possible for you to repair and above all what you must not do !  
You could endanger your safety and lose your warranty.







# SAFETY

***SAFETY EQUIPMENT***

---

***GAS SYSTEM SAFETY INSTRUCTIONS***

---

***FIGHT AGAINST FIRE***

---

***BILGE PUMP SYSTEM***

---

***EMERGENCY TILLER***

---

## POSITION OF THE LIFERAFT



Extra liferaft in cockpit locker to portside.

***NOTE: If over 10 persons on board:  
2 liferafts compulsory.***



## SAFETY EQUIPMENT



The liferaft should be placed in a cockpit locker.

### LIFERAFT

#### RECOMMENDATION

When sailing, never padlock or lock the liferaft locker.  
Before you sail to sea, carefully read the instructions indicated on the liferaft to launch it.

#### WARNING

- Before you sail, list the compulsory safety equipment.
- Don't exceed the number of persons indicated in the chapter 'Specifications'.
- When you don't take into account the number of persons, the total weight of the persons and equipment shall never exceed the maximum load recommended by the manufacturer.
- Use the seats provided.

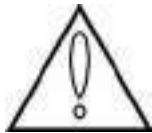

#### RECOMMENDATION

Close the deck hatches and fore portholes each time before each trip  
(including the companionway hatch in heavy weather).

**ADVICE:** *Don't store anything below the floorboards.*

### GAS VALVE



Open valve



Closed valve

1. Valve on appliance
2. Valve on cylinder

**NOTE:** Same position for the other layouts.



#### WARNING

- Don't use a solution containing ammonia.
- Don't use a flame to detect leaks.
- Don't smoke, don't use a naked flame when you change the gas cylinder.

## GAS SYSTEM SAFETY INSTRUCTIONS



Type of cylinder: 'Camping-Gaz' (butane, service pressure 10 kg/cm<sup>2</sup> or according to current standards of your country).

Close the valves on the system and on the cylinder when the appliances are not used.

Close the valves before you change cylinders and immediately in case of emergency.

Never leave unattended an appliance that is working.

Don't install or store flammable materials above or over the stove (curtains, papers, napkins etc.).

Make sure that the valves of the appliances are closed before you open the cylinder or hose valve.

In case you smell gas or find that the burners have gone out (although appliance models cut off automatically if the flames go out), turn off the valves of the appliances. Do ventilate the boat in order to get rid of any residual gas. Find the cause of the problem.

Regularly test the gas system in order to detect any gas leak.

Check all the connections using water and soap or detergent, closing the valves of the appliances and opening the valve on the cylinder.

If you detect a leak, close the valve of the cylinder and repair before you use it again.

The appliances use the oxygen of the cabin and release combustible gases. Ventilate your boat when using appliances.

Don't obstruct the air vents and at least leave the door open.

Don't use the oven or stove as back up heaters.

Lock the stove oven when being not used in order to avoid damaging the tubes when sailing.

Never obstruct the fast access to the components of the gas system.

Keep the taps of the empty cylinders turned off and the cylinders disconnected.

Keep the protection, lids, covers and taps in their places.

Store the empty and spare cylinders on the deck or in a locker with a ventilation to the open air.

Don't use the gas cylinder storage place to store other equipment. Only use the proper locker to store the gas cylinders.

Regularly check and replace the rubber tubings that link the cylinder to one end of the circuit and the stove to the other one, depending on the norms and regulations in force in your country.

Pay particular attention to keep in good condition the screw thread of the cylinder on which the regulator is. Check the condition of the regulator every year and change it if necessary. Use regulators identical to the ones that are fitted.

Have the repairs carried out by someone skilled.

### SUGGESTED LOCATION OF THE FIRE EXTINGUISHERS

Other locations are possible, the extinguishers shall be less than 5 m from all the berths.  
 An extinguisher shall be compulsorily set less than 2 m away from the extinguisher aperture.  
 An extinguisher or a fire blanket (ISO 1869) shall be set less than 2 m from any flame appliance.  
 An extinguisher shall be less than 1 m from the steering station.



#### WARNING

The extinguishers are part of the compulsory equipment.

Extinguisher, per unit, minimum capacity  
 5 A/34 B.

For the SUN ODYSSEY 49 DS: 20 A/136 B  
 (4 extinguishers at least).

1. Against saloon settee
2. Against companionway bulkhead
3. In aft cabin
4. In cockpit locker
5. Extinguisher aperture of the engine compartment



Emergency exits in case of fire

- A. Deck hatch of the fore cabin
- B. Deck hatch of the saloon
- C. Companionway

**NOTE: Same position for the other layouts.**

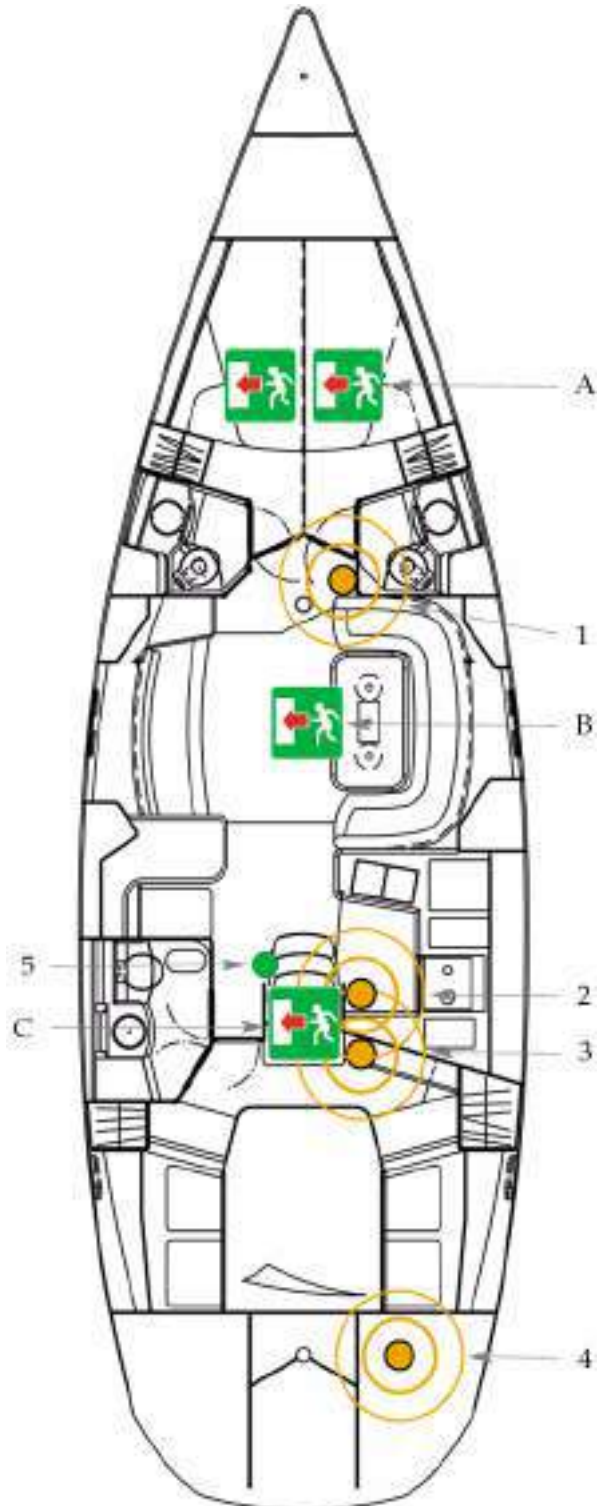



## FIGHT AGAINST FIRE



The extinguishers must be within easy access and kept away from a possible fire source. The engine compartment has an aperture that makes it possible to inject the extinguishing product inside without opening the usual access hatches.

Instructions to follow in case of a fire in the engine compartment bilge:

- Stop the engine.
- Switch off power and stop fuel supply.
- Inject the extinguishing product through the aperture.
- Wait a minute.
- Open the access hatches and repair.

SAFETY

5.3.3 c); 5.3.3 k); 5.5.1 ISO 10 240



1. Fuel oil valve for generating set
2. Fuel oil valve for engine

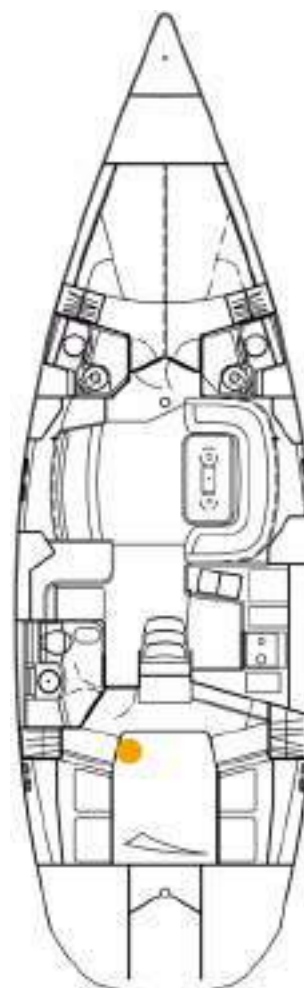

**NOTE: Same position for the other layouts.**







### **WARNING**

Keep an extinguisher handy in case the fire should start again.

It is the owner's or the skipper's responsibility:

- To have the extinguishers checked in pursuance of the instructions given.
- To replace the extinguishers by others with an equal or a greater capacity if the extinguishers have expired or are empty.
- To tell the crew:
  - where the extinguishers are and how they work,
  - where the release aperture is situated in the engine compartment,
  - where the emergency exits are.
- Make sure the extinguishers can be reached easily when people are on board.



### **WARNING**

Never:

- Obstruct the ways to the emergency exits.
- Obstruct the safety controls (fuel oil valves, gas valves, power switches).
- Block the extinguishers placed in shelves.
- Leave the boat unattended when a stove or heater is working.
- Use gas lamps in the boat.
- Alter the boat systems (electricity, gas or fuel oil).
- Fill up a tank or change a gas cylinder when an engine is running, a stove or heater is on.
- Smoke while handling fuels or gas.





Keep the bilge clean. Regularly check whether there is fuel oil or gas vapour.

Use only compatible spare parts for the extinguishers. The parts shall have the same specifications or be technically equivalent as to their resistance to fire.

Combustible products shall not be stored in the engine compartment. If you store non combustible products in the engine compartment, they shall be fastened so that they cannot fall on the machine and block the way.



### WARNING

The CO<sub>2</sub> extinguishers shall be used only to fight **electrical fires**.  
Clear the area immediately after use in order to avoid suffocation.  
Air before entering.

## BILGE PUMP SYSTEM

### ELECTRIC BILGE PUMP

You can energize the electric bilge pump from the electrical panel.

Each pump starts automatically thanks to a release mechanism situated in the sump area.

### EMERGENCY BILGE PUMP

The manual bilge pump is in the cockpit.

The control arm of the pump shall be kept accessible whatever the circumstances.

The pump handle is fastened to the cover of the starboard locker in the cockpit.

***NOTE: The pump is in the same locker.***

## EMERGENCY TILLER



## EMERGENCY TILLER



The emergency tiller is in an aft locker and shall be easy to get to.

To operate the tiller:

- Use a winch handle and unscrew the tiller cover situated at the back of the cockpit.
- Insert the tiller into the rudder stock and make sure it is fully secure in the square.

### RECOMMENDATION

The emergency tiller is designed only to sail at a reduced speed in case of a wheel failure.

SAFETY





# HULL

---

*CONSTRUCTION*

---

*MAINTENANCE OF THE HULL*

---

*CARREENING*

---

*INSTRUCTIONS TO REPAIR THE GEL COAT*





## CONSTRUCTION



Your boat is built in GRP.

Stresses are distributed over the whole bottom surface by means of floors laminated integral with the hull. The iron ballast is fastened to the hull with bolts and backing plates.

The deck is made of balsa wood sandwich with hard wood inserts where the deck fittings are to be installed. The deck-to-hull joint is made of polyurethane filler and it is reinforced by the aluminium foot strap fastening.

HULL

## MAINTENANCE OF THE HULL

The materials and equipments of your boat have been selected because of their high quality and performance and ease of maintenance. However you shall carry out a minimum maintenance in order to protect your boat from outside attacks (salt, sun, electrolysis ...).

Preferably wash your boat on shore.

Use as few cleaning agents as possible.

Don't use aggressive detergent agents or solvents (read next page).

Don't discharge your cleaning product into the water.

### PRECAUTION

We strongly advise you against using a pressure washer.  
You shall not use hot water or steam.

## CARREENING

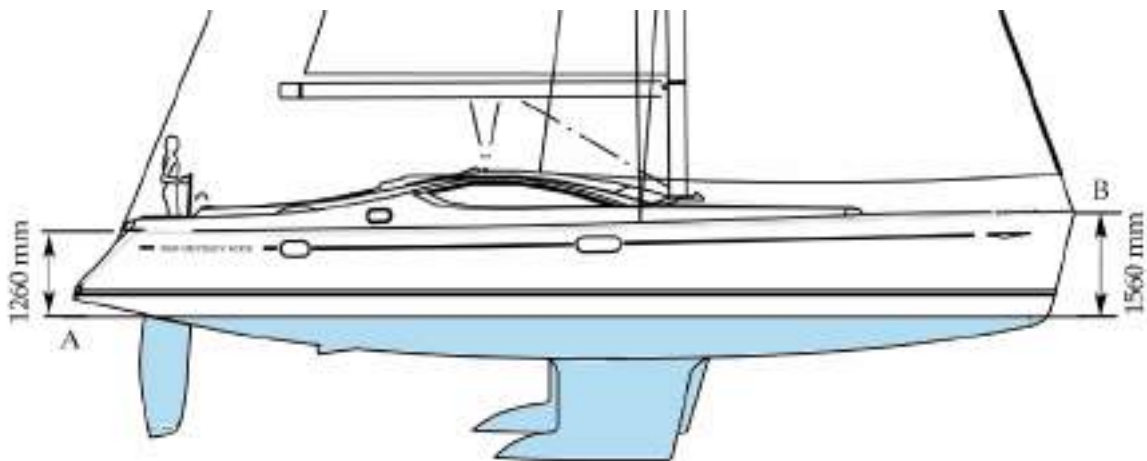

Wetted area: 45 m<sup>2</sup> - (These measurements are for 'light boat')

- A. Water line
- B. Deck line

## CARREENING



Refer to chapter 10 for launching instructions.

A (tin-free) anti-fouling painting every year will make it possible to avoid tedious and frequent careening. An epoxy coat is recommended beforehand. You are reminded that any excessive sanding before your antifouling paint attacks your gel coat and impairs its reliability.

***ADVICE: Gently sand.***

Your boat may regain her shine as new if polished. If a lasting and isolated problem arises, contact your dealer.

The builder tested and approved a certain number of biodegradable cleaning and restoring products that protect both material and environment.

HULL



## INSTRUCTIONS TO REPAIR THE GEL COAT



### MIXING RATIO

Our products contain an accelerator, you just have to add the catalyst (a colourless liquid). The usual ratio is 2 %.

The gel setting time (working time) is about 1/2 h, curing takes about 10 h.



### WARNING

Please respect the following conditions to repair successfully:

- Dry weather.
- Temperature between 15° C and 25° C.

### APPLICATION

- To fill up a blister hole or a scratch, sand and clean the area with acetone.
- Prepare the necessary amount of gel coat, preferably on a glass plate.
- Apply the product with a spatula or a point and the layer shall be thick enough to make possible a further sanding.
- In order to blend minor touching up on smooth surfaces, stick sellotape (or even better, a mylar tape) on the freshly applied gel coat.
- Remove sellotape after curing.
- To get a highly shiny finish, sand with extra fine abrasive and water then polish.



### DANGER

The catalyst is a dangerous product:

- Keep it out of the reach of children.
- Avoid contact with skin and mucous membranes.
- In case of contact wash with soapy water and rinse thoroughly.





### **STORAGE**

To keep them properly, store the gel coat components in a cool dry and dark place.

Keep the components 6 months maximum.

Polyester products are flammable ; take the usual precautions.

### **CLEANING YOUR TOOLS**

Clean all your tools with acetone.







# DECK

---

*NAVIGATION*

---

*MOORING*

---

*TOWING*

---

*ANCHORING*

---

*MAINTENANCE OF THE DECK*

---

*STEERING GEAR*

## DECK LAYOUT

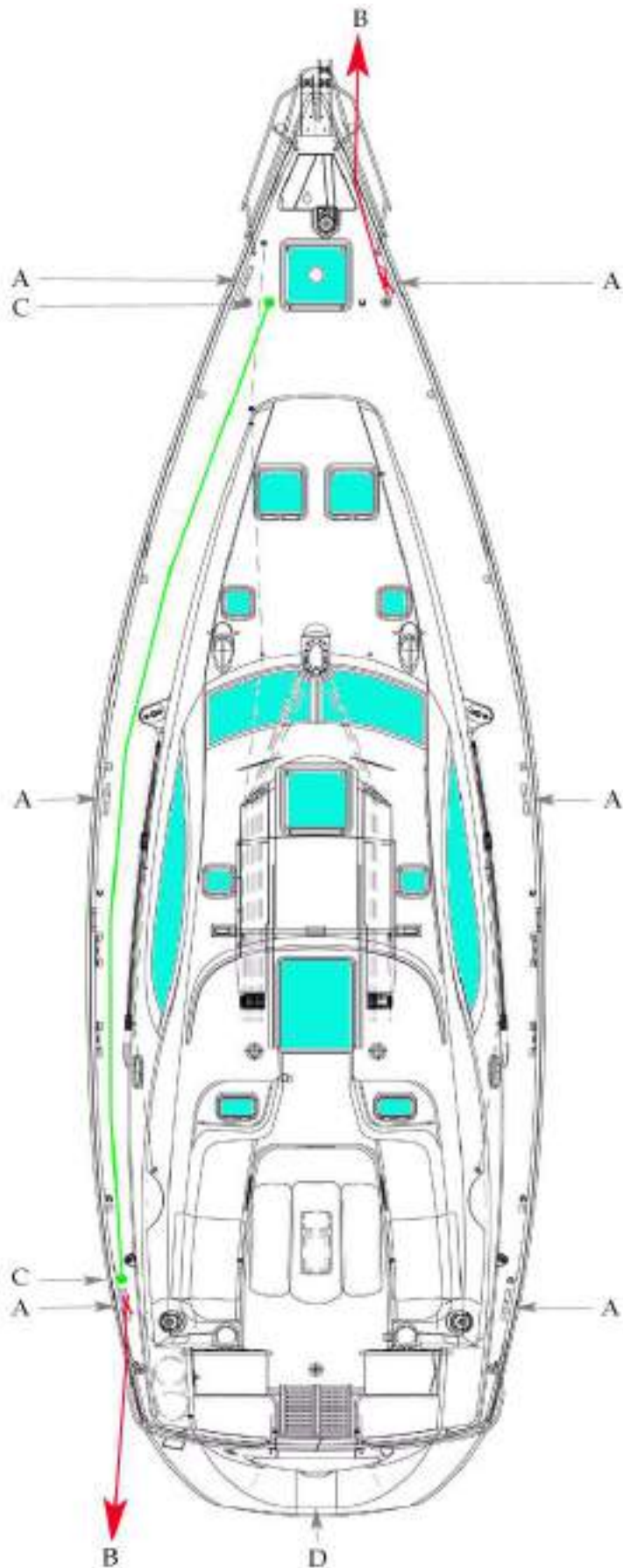

- A. Mooring cleats
- B. Towing
- C. Lifeline (fastened on the mooring cleats or on the optional chainplates)
- D. Swimming ladder

## NAVIGATION



### **DANGER**

Wear your life jacket.

In heavy weather, wear your safety harness and fasten yourself to the boat.  
When sailing, close and lock the door or doors giving access to the transom extension

DECK

## MOORING

A sufficient number of mooring lines suitably sized and suitable for the environment shall be on board for mooring your boat.

- Always manoeuvre your boat using the engine.
- Make allowance for the current and wind when you handle your boat.
- Protect your boat to the highest degree with suitably sized fenders.
- Always keep the mooring ropes unfouled and stored away.
- Handle your boat at a reduced speed.



### **DANGER**

Don't try to stop the boat with your foot, your hand or a boat hook.

### **AFTER MOORING**

- Protect the mooring lines against chafing with plastic sleeves.
- Make allowance for the variations in tides if need be.

## TOWING

### **TOWING BOAT**

- Tow another boat at a reduced speed and as smoothly as you can.
- Pay particular attention when you throw or catch the towing rope (it may foul on the propeller).

***NOTE: The stability may be reduced when you tow a boat.***

### **TOWED BOAT**

- Keep steering your boat and see to it that you stay in the wake of the towing boat.





## ANCHORING

As a rule, set the anchor in at least 3 times the depth of water.

### PRECAUTION

Before anchoring check the depth of water, the power of the current and the nature of the sea bed.

## ANCHORING

### PRECAUTION

Keep the engine running during the anchoring operations to avoid discharging the batteries.

- Have your boat pointed into the wind and without speed.
- Pay out the chain while moving back slowly.
- Secure the cablet on the mooring cleat.





## HEAVING UP THE ANCHOR

- Lock the cable lifter snubber.
- Ensure the chain is properly set on the cable lifter.
- Slowly go near the anchor, using your engine (Don't use your windlass to winch the boat).
- Heave the anchor completely.
- Visually check the last meters till the anchor gets into contact with the davit.
- If you just change berth, check the position of the anchor on the stem fitting.

**ADVICE: When you are sailing for a long period of time, store the anchor in the anchor locker.**

- With an electric windlass, switch the power off as soon as the chain is fast.

## STERN ANCHORING

Stern anchoring shall be performed with the engine declutched.

- Secure the required length of cablet on the mooring cleat.
- Pay out the anchor line slowly.
- Take care you don't damage the propeller or rudder.

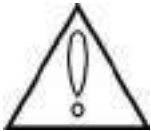

### WARNING

Windlass operations are dangerous:

- Always keep the anchor line unfouled and free.
- Always proceed with care, using gloves and always wearing shoes.

## MAINTENANCE

### RECOMMENDATION

After each trip rinse the windlass and mooring line with fresh water.  
Refer to the manufacturer's instructions for windlass maintenance at the beginning or end of the season.





## MAINTENANCE OF THE DECK



Preferably wash your boat on shore.

Use as few cleaning agents as possible.

Don't use solvents or aggressive detergent agents (Refer to chapter 3 "Hull").

Don't discharge cleaning products into the sea.

Regularly brush the deck with a degreasing shampoo and fresh water.

***ADVICE: Use only products similar to the ones that are included in the maintenance case you have been delivered with your boat.***

### DECK FITTING

- Rinse thoroughly all your equipments with fresh water.
- Periodically lubricate blocks, sheaves, bottle screws, winches, rails and travellers with a water-repellent grease.
- Clean and polish with "Rénovateur chrome et inox Jeanneau" (supplied in the maintenance case) the stainless steel parts that may have small rusty spots or minor oxidation pits.

### OUTSIDE TEAK WOOD/TEAK DECK

Regularly clean the woodworks with fresh water using a sponge (if need be add some gentle soap).

***ADVICE: Don't use a pressure washer.***

### PLEXIGLAS

- Rinse plexiglas with fresh water.
- Brighten up with a soft rag soaked with liquid paraffin.
- Use polish paste to remove scratches.

### PRECAUTION

Don't use solvent, alcohol, acetone on plexiglas.

## STEERING GEAR

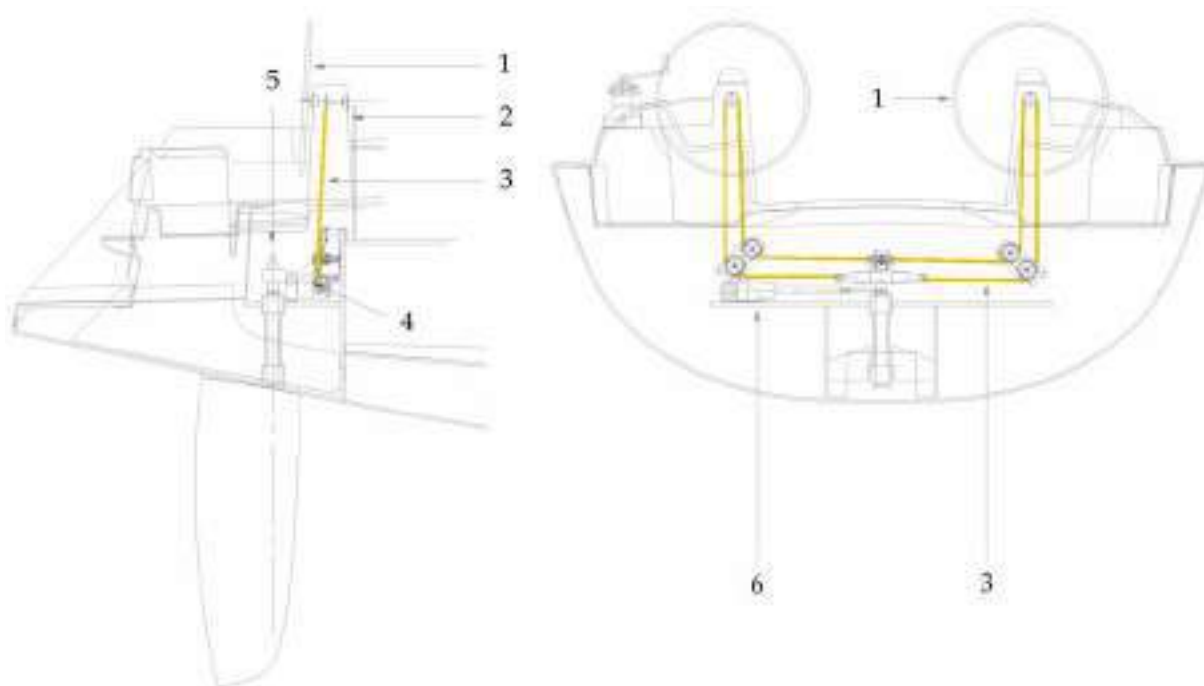

Access to the steering cables through the aft cockpit locker

1. Steering wheel
2. Wheel column
3. 6 mm diameter steering cable
4. Cable adjustment
5. Emergency tiller
6. Auto pilot (Optional extra)



## STEERING GEAR

- Regularly check the tightening of the different parts.
- Don't tighten the steering cables excessively.
- Lubricate all the elements.

Maintain the nylon, ertalon or teflon bushes only with WD40.





# RIGGING AND SAILS

*STANDING RIGGING*

---

*RUNNING RIGGING*

---

*WINCHES*

---

*SAIL SETTING*

---

*SAILS*

---

## STANDING RIGGING

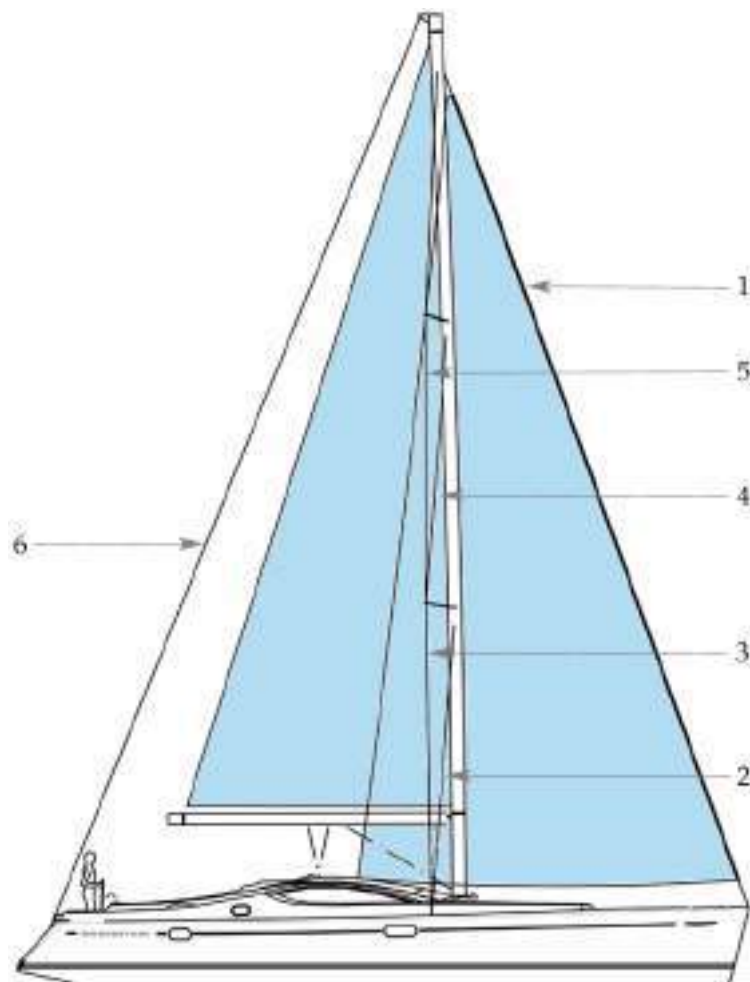

	Designation	Number	Type	Diam. (mm)	Length (m)
1	Forestay	1	1*19	12	17,730
2	D1	2	1*19	12	6,090
3	V1	2	1*19	14	6,030
4	D2	2	1*19	8	5,840
5	V2/D3	2	1*19	12	10,860
6	Backstay	2	1*19	8	19,550

## STANDING RIGGING



Your JEANNEAU dealer was responsible for stepping the mast of your boat.

To mast or unstep the mast yourself, proceed as follows:

### BEFORE MAST INSTALLATION

- Protect the mast against possible chafing by the crane hook and cable.
- Tie down the shrouds and all the riggings to the base of the mast with a lashing long enough to guide the mast heel when stepping the mast.
- Protect the spreader end fittings and the roller furler drum.
- Put a rope of about 1,50 m with an eye and thimble at both ends and covered with rags round the mast. Place the rope under the second tier of spreaders. Link together both thimbles (that are ahead of the mast) with a shackle large enough to receive the crane hook. Raise the whole till it is taut under the spreader bases.



### DANGER

Before you lift the mast, make sure you have room that is clear enough  
(Risk of electrocution when in contact or near electric cables).

### DURING MAST INSTALLATION

- Take the necessary steps to avoid damaging the mast head equipments.
- Use the backstay and lashing at the base of the mast to control the handling.
- Make sure the base of the mast integrally bears on its base plate.







## **AFTER MAST INSTALLATION**

- Check the spreaders for tightening and position (always above the horizontal position).
- Lubricate all the bottle screws.
- Stretch tightly the rigging (Refer to chapter 5, "Cable adjustment").
- Reconnect the electric cables (Refer to chapter 8, "Electricity").
- Check the tightening of the fastening pins on the bottle screws. Protect the fastening pins with adhesive tape.
- Put the boom back. Refit all ropes.
- Adjust the mast after a few trips.

## IN-MAST ROLLER FURLER

1. Masthead light
2. Backstay attachment
3. Spinnaker halyard sheave
4. Main furler swivel
5. Shroud attachment
6. Spinnaker halyard eye
7. Forestay attachment
8. Genoa halyard sheave
9. Flying baby stay fitting (Optional extra)
10. Spi pole lift halyard sheave (genoa 2)
11. Spreader attachment + Shroud attachment
12. Mouse line for radar
13. Engine navigation light / Deck searchlight
14. Spi pole traveller sheave
15. Spi halyard exit
16. Genoa halyard exit
17. Spi pole topping lift exit / Genoa 2 (Optional extra)
18. Boom topping lift exit
19. Main halyard exit
20. Spi pole rail
21. Main topping lift cleat
22. Spi pole traveller adjustment cleat
23. Spi pole eye
24. Mast step
25. Vang fittings
26. Furling mechanism
27. Gooseneck
28. Main furling line eye
29. Main sheet eye
30. Boom rail
31. Boom traveller
32. Boom fitting

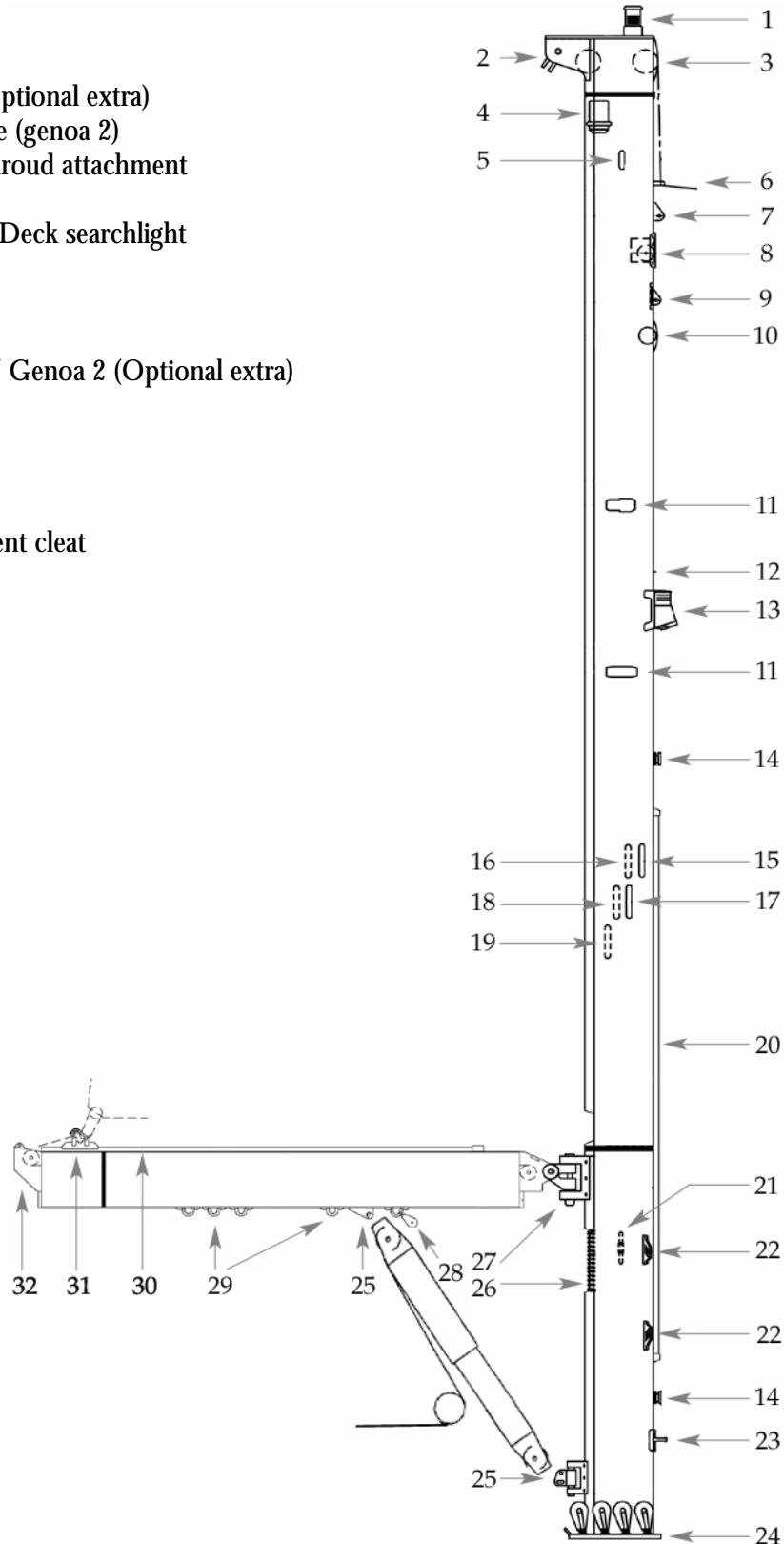



## UNSTEPPING THE MAST

- Mark the rope locations with stickers.
- Proceed in reverse order compared with the mast installation.

## CABLE ADJUSTMENT

A professional carried out the pre-adjustment and the cable tightening.

After a few sea trips, adjust the mast definitively to get a perfect widthwise rectitude of the mast.

To keep the mast straight lengthwise **when sailing** get a balanced adjustment when in port:

- Classical mast:
  - Slightly pre-bend the mast lengthwise, the middle of the mast bending forwards and the head backwards.
  - The pole shall be about half the section of the profile.
- In-mast roller furler:
  - Pre-bend the mast lengthwise **very slightly**.
  - The pole shall be **smaller** than the half of the profile section.

## BALANCE ADJUSTMENTS IN PORT

- Before you fasten the backstay, tighten the upper shrouds (because the boat is rigged with swept back spreaders).
- Tighten hard the whole rigging (when sailing with 15 to 20 knots, the leeward rigging is slightly slack and it is normal).
- After getting a perfect widthwise and lengthwise rectitude when in port, symmetrically slacken the aft lower shrouds (on portside and starboard) by 2 bottle screw turns.
- To end the lengthwise adjustment, tighten hard the backstay bottle screws till you get a fair stability of the forestay when sailing with a wind at 15 to 20 knots.

Keep all the bottle screws adjusted and use the pins. Keep the adjustment throughout your sailing season.

**ADVICE: When you are not sailing, slacken the backstay.**

## CLASSICAL MAST

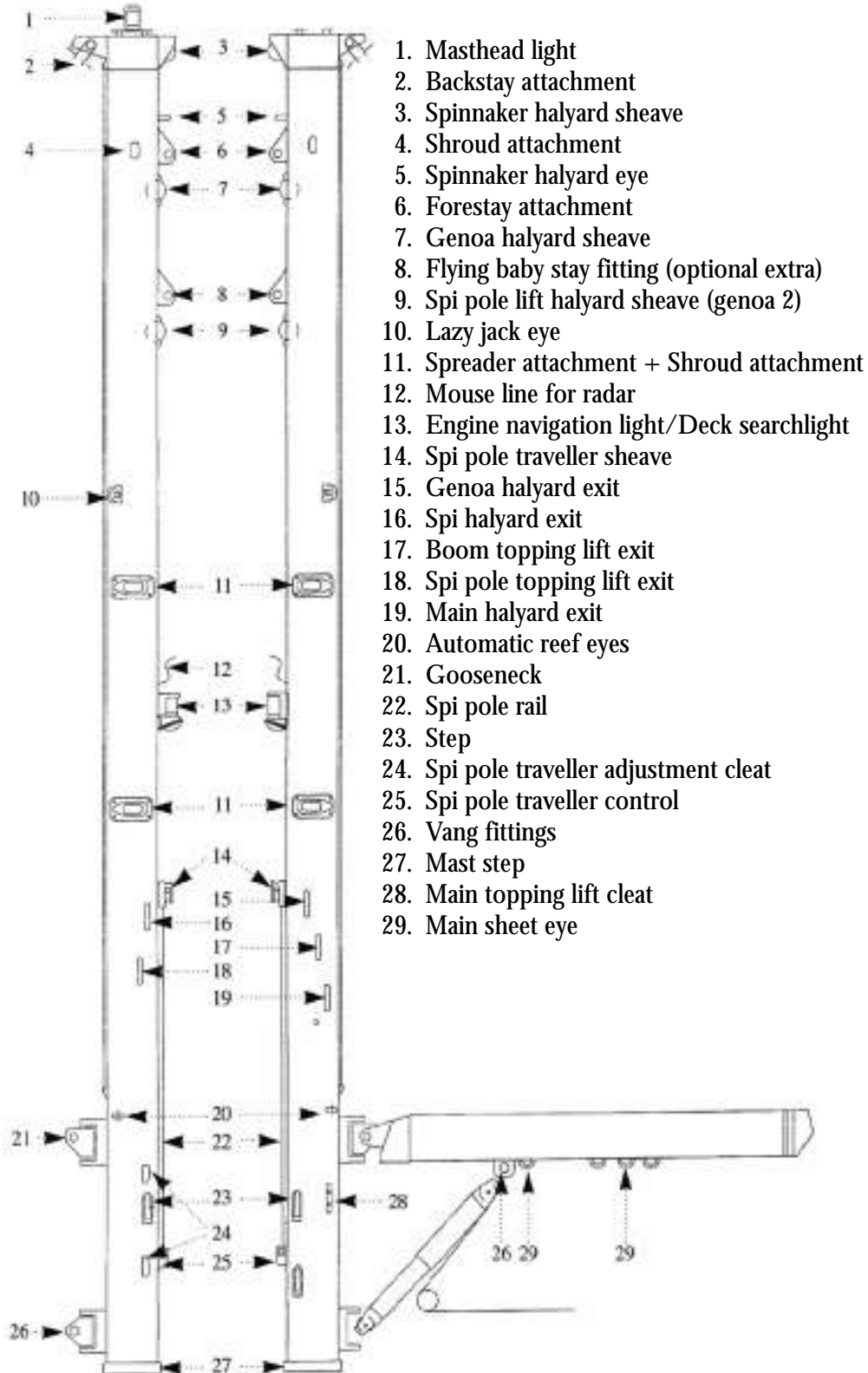



## MAINTENANCE

Before each trip, carefully inspect the mast from top to bottom.

Periodically check the rigging tightening and the lock nut or pin locking (you should check it for the first time after a few days sailing in all types of weather).

Secure and lubricate the bottle screws with tallow, graphite grease or other.

Never lubricate the bottle screws with silicone.

Check the bottle screw tightening.

Inspect the bottle screws for possible wear (due to the chainplate friction if the rigging is slack).

Change any shroud or stay with severed wires or kinks.

Regularly check the chainplates and inside tie rods for condition.



### DANGER

To hoist a crew member up to the top of the mast, make a bowline with the halyard directly on the bosun's chair ring

(never use the halyard snap shackle or shackle).

Do not hoist a crew member when sailing in heavy weather.

***ADVICE: Your JEANNEAU dealer can carry out all the maintenance operations.***

## RUNNING RIGGING FURLING MAINSAIL

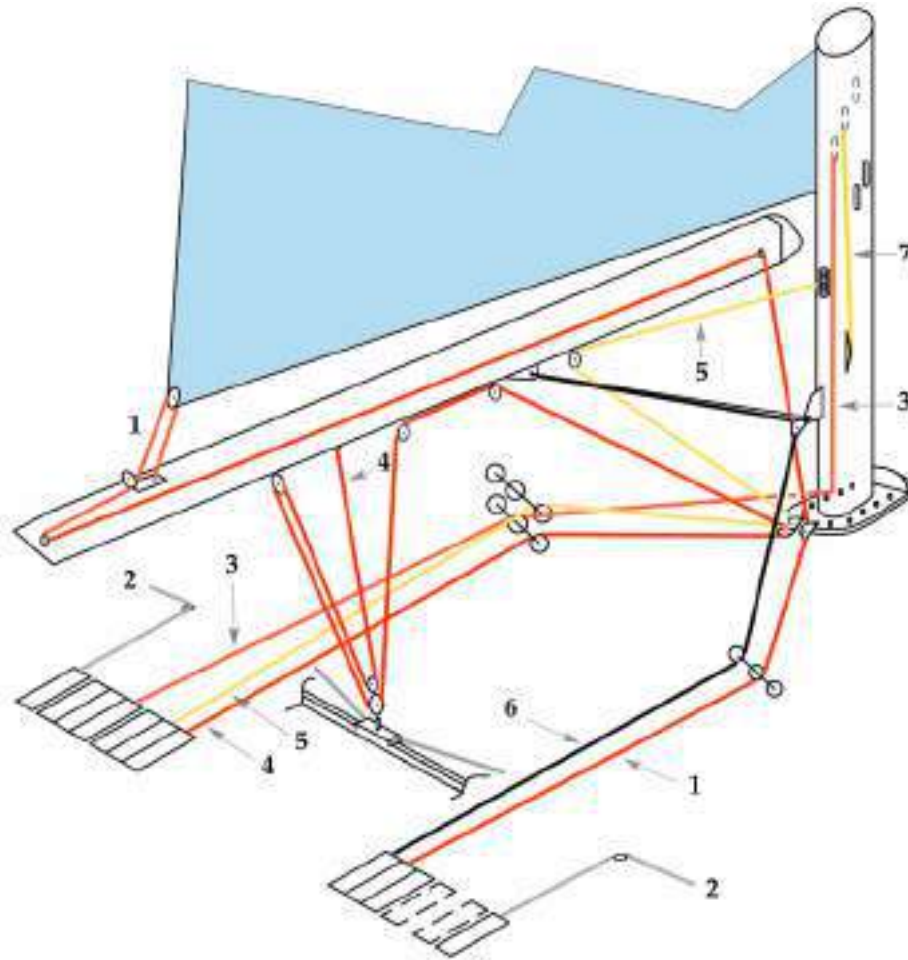

	<b>Rope designation</b>	<b>Num ber</b>	<b>Type</b>	<b>Colour</b>	<b>Diam. (mm)</b>	<b>Length (m)</b>
1	Foot tuning line	1	FO	White/red	12	19
2	Traveller adjustment	2	FO	White	8	8
3	Main halyard	1	FO	White/red	12	41
4	Main sheet	1	FO	Red	12	25
5	Main furling line	1	FO	White/yellow	10	24
6	Kicking strap	1	FO	Black	10	27
7	Boom topping lift	1	FO	White/yellow	10	36

FO: Halyard braid

## RUNNING RIGGING



### MAINTENANCE

Lubricate the sheaves with silicone. Change any distorted or dented sheave. Inspect the pins of the sheaves at the top of the mast once a year.

Regularly check the jam cleat jaws for condition.

Inspect the halyards for wear and condition.

Regularly clean the blocks (waste grease, corrosion spot).

Slightly lubricate the block pins.

Avoid untimely gybes in order to reduce the premature wear on the sheets and attachment points.

## RUNNING RIGGING CLASSICAL MAINSAIL

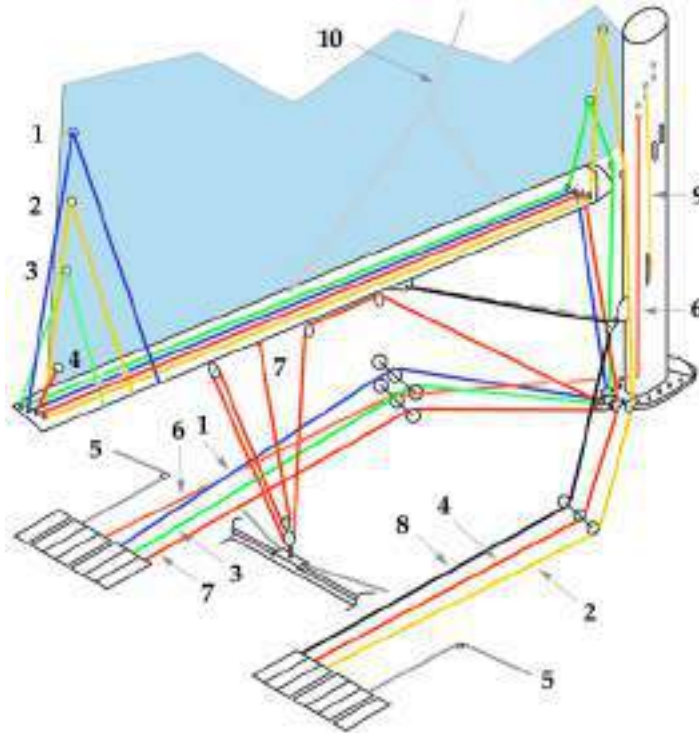

	<b>Rope designation</b>	<b>Num ber</b>	<b>Type</b>	<b>Colour</b>	<b>Diam. (mm)</b>	<b>Length (m)</b>
1	Reef 3 (Optional extra)	1	FO	White/blue	12	27
2	Reef 2 (Automatic)	1	FO	White/yellow	12	30
3	Reef 1 (Automatic)	1	FO	White/green	12	23
4	Foot tuning line	1	FO	White/red	12	14
5	Traveller adjustment	2	FO	White	8	8
6	Main halyard	1	FO	White/red	12	41
7	Main sheet	1	FO	Red	12	25
8	Kicking strap	1	FO	Black	10	17
9	Boom topping lift	1	FO	White/yellow	10	36
10	Lazy-jacks	2	FO	White	6	8/6/5

FO: Halyard braid



## WINCHES



Avoid rope jamming during winch handling. Do not leave loose ropes on the winches but fasten them on cleats.

Adjust the winches on receipt of your boat (rinse them regularly during the season). The winches should rotate freely, they need overhaul as soon as it slightly seizes.

### MAINTENANCE

#### RECOMMENDATION

Carry out the complete maintenance of the winches regularly (before and during the sailing season).

- Remove the drums and clean them.
- Lubricate the drums with a film of white grease or Teflon to reduce the friction and fight against corrosion (this type of grease is clean, non toxic and biodegradable).

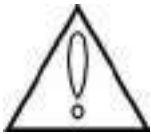

#### WARNING

Refer to the manufacturer's instructions to remove the winches and put them back. Improper refitting may result in accidents (e.g. kick of the crank handle).

---

## IN-MAST ROLLER FURLER



Hatch to set the mainsail

1. Head shackle
2. Tack shackle

## SAIL SETTING



### FURLING MAINSAIL (IN-MAST ROLLER FURLER VERSION)

- Remove the hatch giving access to the furling mechanism.
- Spread out the sail on the deck.
- Fasten the head (strap) to the shackle of the upper swivel. Pay attention to the winding direction.
- Insert the foot adjustment line into the clew block.
- Slowly hoist the sail. Guide the bolt rope (sometimes the groove leading edges may be insufficiently smoothed off).
- When the sail is up, tack it to the lower shackle.
- Gently sweat up the halyard.
- Refit the hatch.
- Furl the sail facing the wind and keeping a very slight tension on the foot. The main sheet must be eased off.

***ADVICE: When the sail is unfurled, adjust the halyard tightness.***

### RECOMMENDATION

Too much tightness may cause furling problems. After sailing, slightly slacken the halyard.

## RUNNING RIGGING FOR THE GENOA

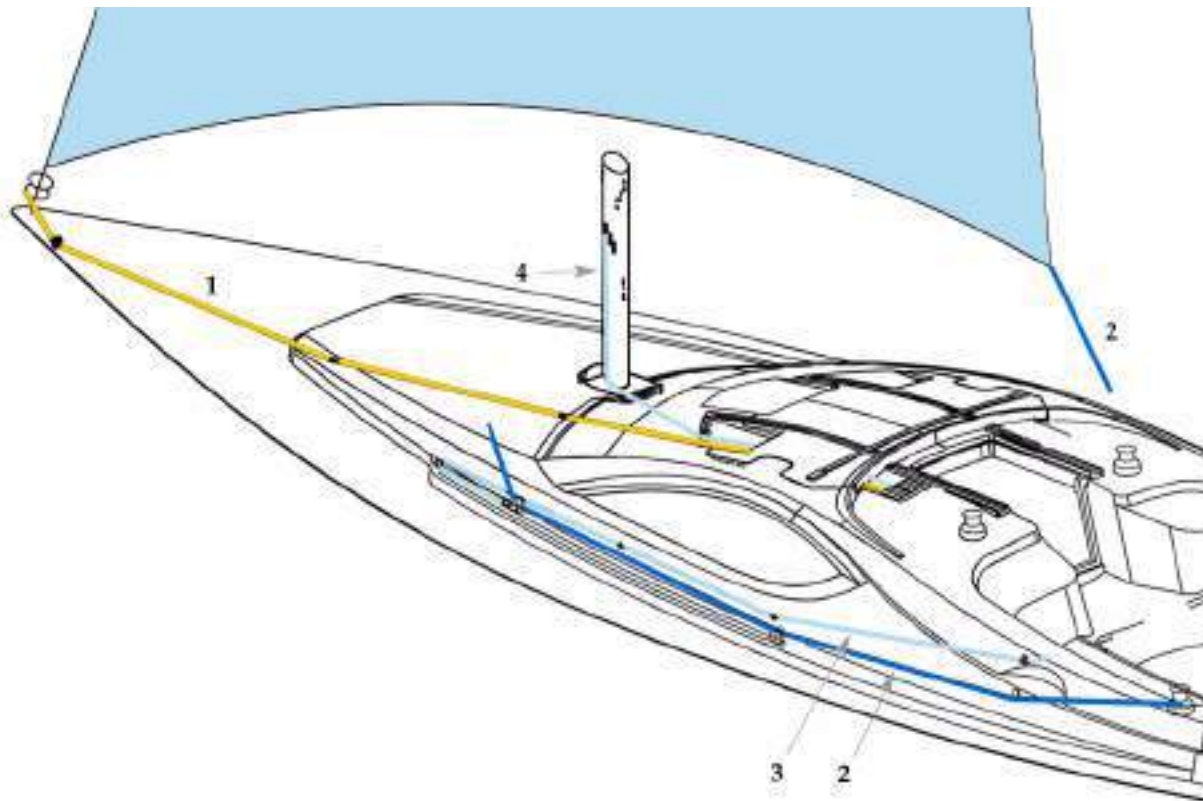

	<b>Rope designation</b>	<b>Number</b>	<b>Type</b>	<b>Colour</b>	<b>Diam. (mm)</b>	<b>Length (m)</b>
1	Genoa furler	1	FO	White/yellow	10	24
2	Genoa sheet	2	FO	Blue	14	17
3	Traveller adjustment	2	FO	White/blue	8	12
4	Genoa halyard	1	FO	White/blue	14	40
	Staysail sheet (optional extra)	2	FO			
	Staysail halyard = spinnaker boom topping lift					

FO: Halyard braid



## FURLING GENOA

Before getting under way take advantage of a windless period of time and hoist the genoa.

Hand pre-roll the drum to set the furling line on it.

Pay attention to the drum winding direction: The sacrificial strip of the genoa shall be wrapped outside.

- Secure the head and halyard to the swivel. Secure the tack to the drum and sheets.
- Insert the bolt rope into the hole and hoist it and take care that you do not tear it.
- Have the halyard taut enough but hoist less taut than a sail on a normal stay. Hoist it until the horizontal creases disappear (Adjust the tension of the luff after a few sea trips).
- Before you furl the genoa, remove the part that is used to guide the bolt rope. Keep this ring in a safe place and put it back before any handling (lowering etc.).
- Pull on the line from the cockpit to furl the genoa.

Never force it in case it seizes when you furl or unfurl the head sails. Make sure a halyard is not jammed in the furler.

***ADVICE: When you are not sailing, slacken the genoa halyard.***

## MAINTENANCE

- Regularly rinse the drum and swivel.
- Lubricate the bearings if recommended by the manufacturer.
- Unrig the sails if your boat is not to be used for long.

## RUNNING RIGGING - SYMMETRIC SPI

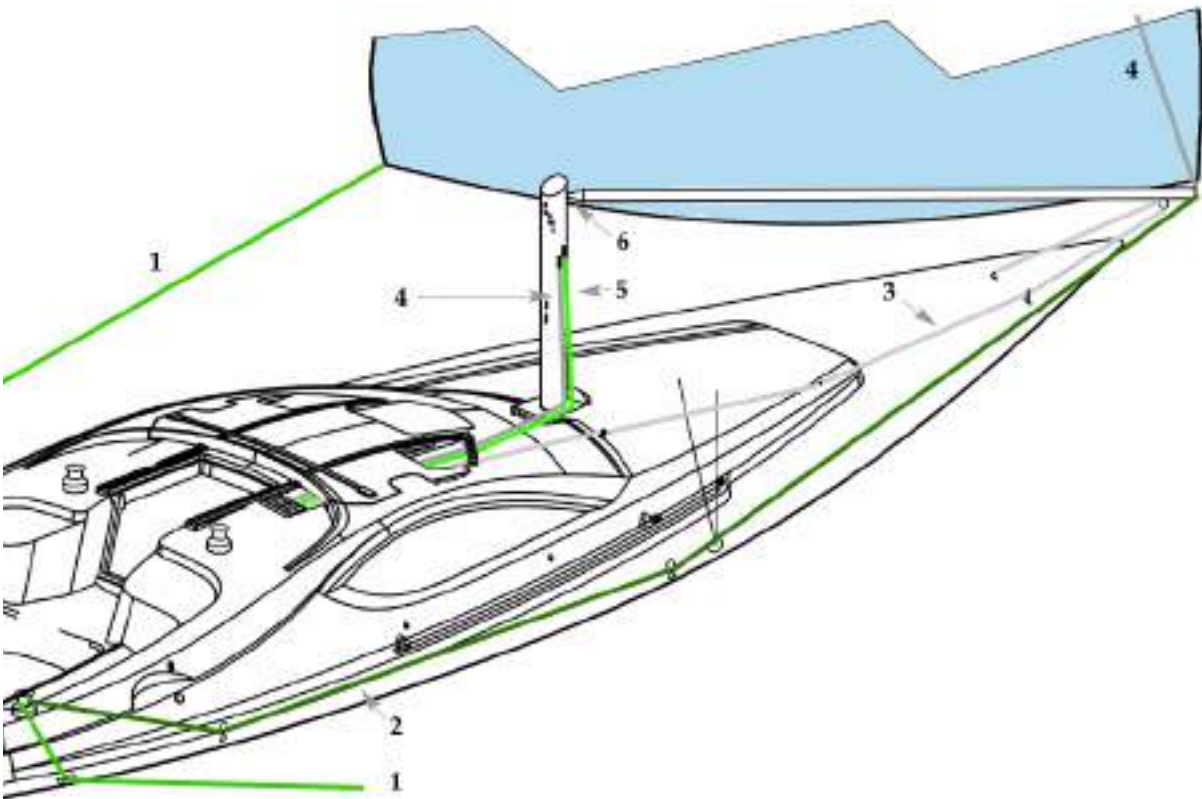

	<b>Rope designation</b>	<b>Number</b>	<b>Type</b>	<b>Colour</b>	<b>Diam. (mm)</b>	<b>Length (m)</b>
1	Spinnaker sheet	2	Dy	White/green	12	27
2	Spinnaker guy	2	Dy	Black/green	12	27
3	Spinnaker boom downhaul	1	FO	White	10	23
4	Spinnaker boom topping lift	1	FO	White/black	10	40
5	Spinnaker halyard	1	FO	White/green	12	43
6	Spinnaker boom traveller adjusting line	1	FO	Blanc	8	12,5

FO: Halyard braid



### **LAZY-BAG (OPTIONAL EXTRA)**

- Spread out the lazy-bag on the deck.
- Slide the battens in and close the batten pockets.
- Hank on the lazy-bag until you have the front part about level with the gooseneck.
- Fasten the lazy-bag to the tack with the strap provided.
- Stretch the lazy-bag from the back before you fasten the lazy-jacks.
- Tighten up the port side.
- Put the mainsail into the lazy-bag.
- Tighten up the starboard side.

***ADVICE: Install the lazy-bag before the mainsail.***

### **CLASSICAL MAINSAIL (OPTIONAL EXTRA)**

With the mainsail being on the deck:

- Screw the pins of the mast sliders for battens into their boxes.
- Slide in the battens through the leech.
- Screw the box cap until you get the required tension (the tightening screw shall not project beyond the sail).
- Do not forget the small locking screw.

Put the mainsail into the lazy-bag.

- Set the boom ring in velcro about level with the clew.
- Fit the mainsail onto its slides, begin with the headboard and finish with the tack.

***ADVICE: Weather permitting, hoist the mainsail gradually.***

### **STAYSAIL (OPTIONAL EXTRA)**

Install the flying baby stay then proceed as follows:

- Spread the staysail on the deck.
- Fasten the tack pig tail.
- Fasten the luff snap hooks and you will begin by the lower part.
- Fasten the sheets then hoist.

## RUNNING RIGGING - ASYMMETRIC SPI

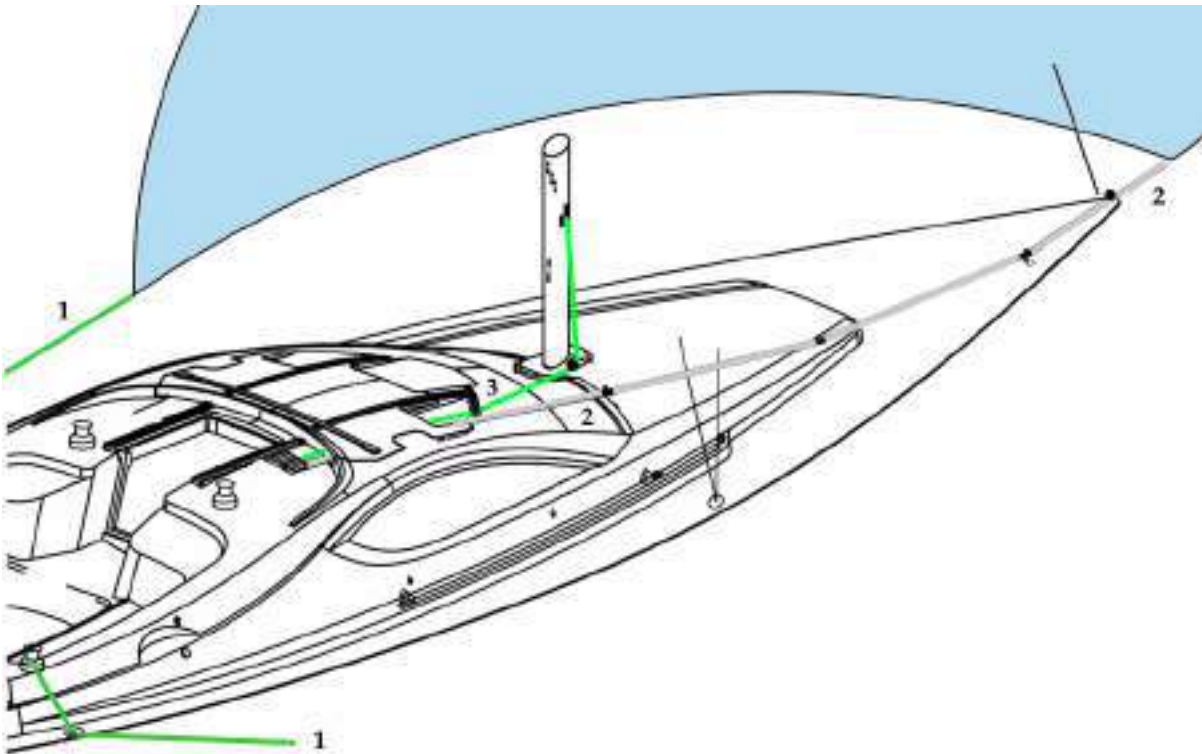

	<b>Rope designation</b>	<b>Number</b>	<b>Type</b>	<b>Colour</b>	<b>Diam. (mm)</b>	<b>Length (m)</b>
1	Spinnaker sheet	2	FO	White/green	12	27
2	Tack	1	Dy	White	12	25
3	Spinnaker halyard	1	FO	White/green	12	43

FO: Halyard braid  
Dy: Dyneema



## SAILS



How long a sail lasts mainly depends on its regular maintenance.

***Piece of advice: At the end of the sailing season, and if possible before winter, leave your sails to a specialist to have efficient maintenance and repairs.***

When sailing, trim the sails properly in accordance with the stresses in order to reduce the harmful strains on the fabric.

Avoid tears and wear: Use protective items against chafing on the the accessories with rough surfaces (protective items for spreaders, stanchions etc.).

Between two sea trips, slacken the halyard (for the sails on furler) and the mainsail foot tuning line.

Have a sail maker's kit and a user's manual so that you may carry out the emergency repairs waiting for the sailmaker's assistance.

### **CLEANING AND MAINTENANCE**

Rinse the sails with fresh water from time to time and dry quickly in order to avoid mildew.

Avoid drying the sails to windward when on the mast (when the sails lift, the seams are worn, the sails may be torn by the rigging).

To remove grease stains: Use trichlorethylene then immediately rinse with water.

### **SAIL STORAGE/FOLDING**

Avoid storing a wet sail to prevent mildew from appearing.

Accordion fold the sail parallel to the foot, then roll it up to the bag dimensions.

### **PROTECTION**

UV rays are harmful to polyester and nylon. If the sails remain on the mast, even for 24 h, protect them with a cover or a protection fabric placed on the leech and foot of the furled sails.

Our agents' network offers you accessories that have been selected by the yard and are consistent with your needs.





# ACCOMMODATIONS

---

*MAINTENANCE*

---

*FABRICS*

**2 CABINS  
2 WASH ROOMS**

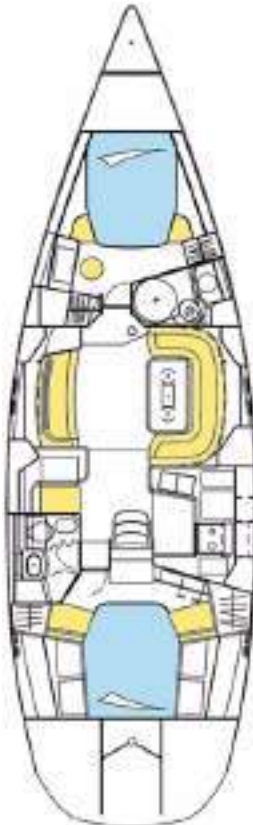

**3 CABINS  
2 WASH ROOMS**

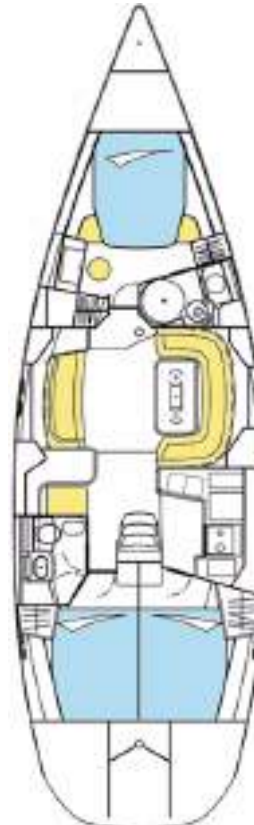

**3 CABINS  
3 WASH ROOMS**

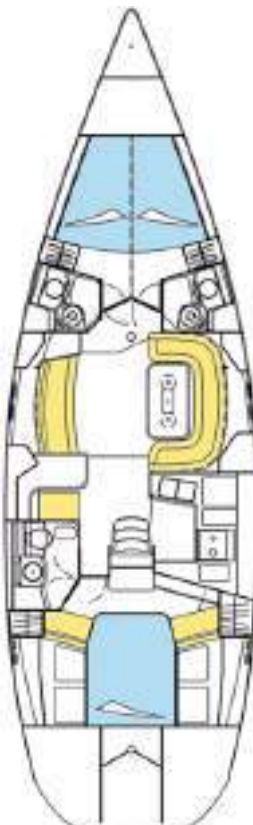

**4 CABINS  
3 WASH ROOMS**

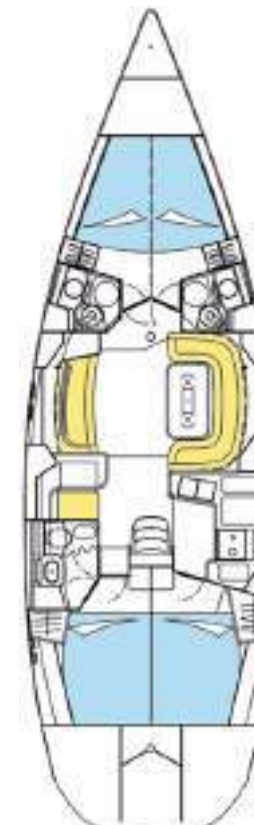

## MAINTENANCE



### INSIDE

- Take advantage of the fine weather to take the settee and berth cushions out.
- Put the cushions vertically if you leave the boat for long.
- Use blinds to protect the inside of the boat against UV rays.
- Carefully remove all crumbs.
- Make sure the bilges are clean and dry.

### INSIDE VARNISH

- Rinse the inside varnish with fresh water mixed with spot remover and shampoo.
- Polish the inside varnish with shammy leather.

### RECOMMENDATION

Preferably wash your boat on shore.  
Use as few cleaning agents as possible.  
Don't discharge your cleaning product into the water.

---

## CONVERSION OF THE FORE CABIN



1. Unbolt and take off the upper part of the central bulkhead.
2. Lift the lower part of the central bulkhead.
- 3., 4., 5., 6. Take off the other sections by sliding them out.

## STORAGE OF THE REMOVABLE BULKHEADS



7. Unscrew the vertical panel of the locker under the berth.
8. Store the bulkhead sections.

## FABRICS



***ADVICE: Mark up each cover and foam when dismantling.***

### STAIN REMOVAL

- Remove as much stain as you can with a knife blade (from the edge towards the centre).
- Dab with a clean rag.
- Remove the stain with solvent on a clean rag. Never pour the solvent directly over the stain.
- Rub with a clean and dry rag.
- Brush the fabric against the grain.
- Use the vacuum cleaner when the fabric is dry.

### PVC OR COATED FABRICS

- Use a sponge and water and soap (household soap type).
- Dab away resistant stains with a rag soaked with white spirit, do not rub them.

### PRECAUTION

For the PVC fabrics, don't use any solvent or solvent based product (pure alcohol, acetone, trichloroethylene).

---

## CONVERSION OF THE AFT CABIN



1. Remove the port engine hatch.



1. Unbolt.
2. Take off the central bulkhead pulling on the handle.



3. Take off the first section of the bulkhead.
4. , 5. Take off the other sections sliding them.

***NOTE: All the bulkhead and face sections are stored below the aft berth.***



## FABRICS



### **100% POLYESTER/DRALON JACQUARD**

If you cannot remove the fabric:

- Clean with the vacuum cleaner.
- Clean with synthetic foam (please refer to the product instructions).

If you can remove the fabric:

- Hand wash with an ordinary washing powder at 30° C.

In both cases, dry cleaning is possible. Remove the stains as soon as possible with a damp rag.

### **COTTON JACQUARD**

- Dry clean.
- Do not iron.
- Do not use hypochlorite.
- Remove the stains with fractionated petrol.

### **ALCANTARA**

- Wash in warm water with a neutral pH soap.
- Dry it naturally.
- Dry clean with perchloroethylene.

### **LEATHER**

- Use a leather cream for ordinary care.
- Do not use detergent.
- Do not use silicone based products.
- Clean with a sponge and soapy water.
- Remove ball point pen marks with methylated spirit.
- Remove the grease stains with an absorbent powder (e.g. talcum powder).





**MAINTENANCE**

**RECOMMENDATION**

The builder tested and approved a certain number of biodegradable cleaning and restoring products that protect both material and environment.

The related technical data is available at your JEANNEAU dealer.





# PLUMBING

---

***WATER TANK FILLING***

---

***FRESH WATER SYSTEM***

---

***GAS SYSTEM***

---

***DRAINAGE SYSTEM***

---

***SANITARY APPLIANCE OPERATION***

---

## WATER AND GAS DISTRIBUTION

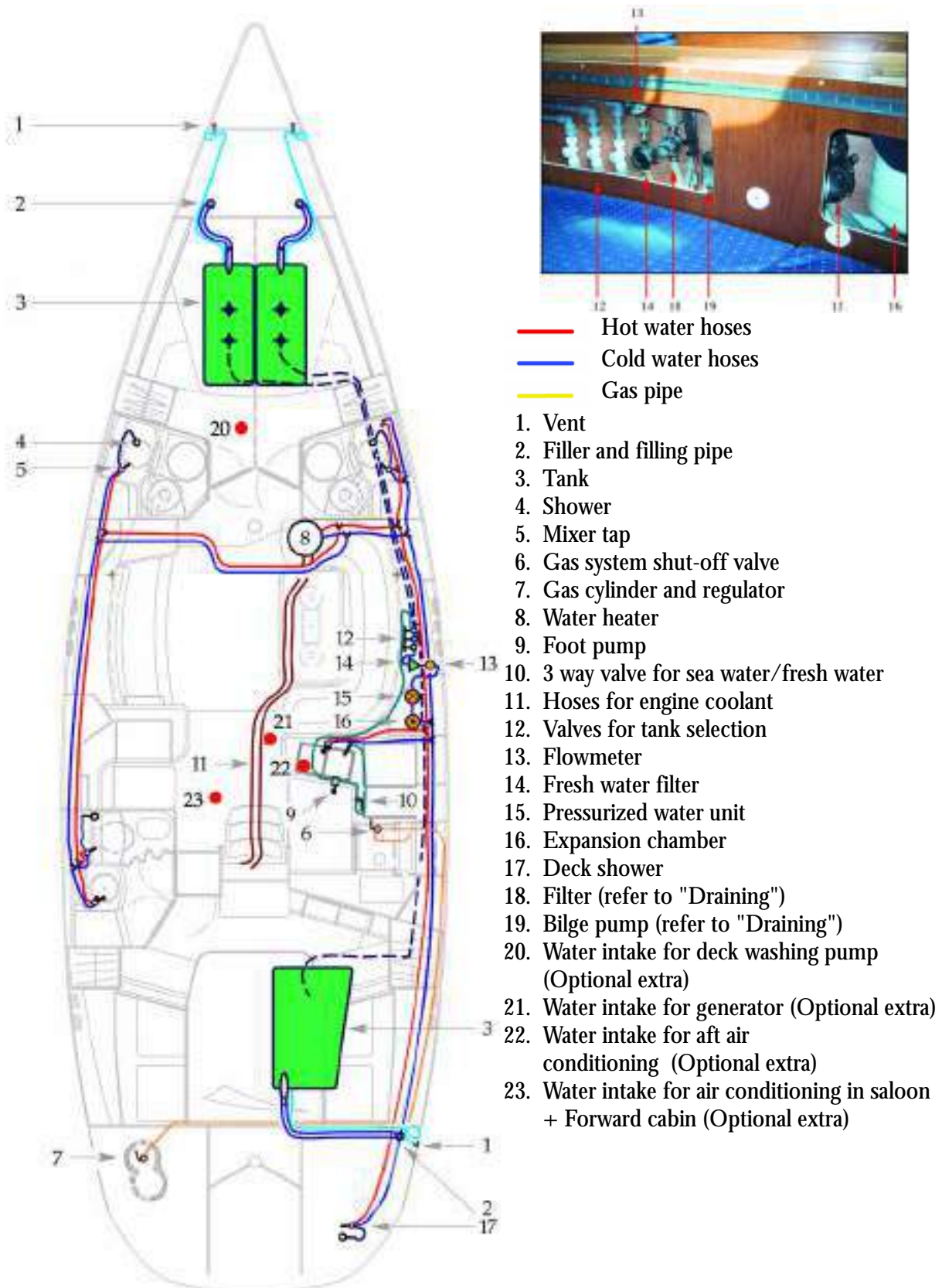

**NOTE:** Same position for the other layouts.

## WATER TANK FILLING



In order to prevent any handling mistakes, never fill the water and fuel tanks at the same time.

During filling, avoid handling contaminants near the fillers.

Open and close the filler caps with the suitable key.

Check the filler cap seals for condition during filling.

The tanks are fitted with overflow outlets and vents.

Never insert the water filling hose deep down into the system in order to prevent any over-pressure in the systems.

### MAINTENANCE

#### RECOMMENDATION

- Pay attention to the quality of the water for the filling up. Check if it is drinking water.
- It is possible to sterilize the tanks with a Clonazione tablet (sold at the Chemist's).
- If the boat is not used for long, purify the tanks and pipes with acetic acid (or white vinegar).
- Inspection ports are provided on tanks and make possible the cleaning of the inside.
- Do not use chlorine-based products (they may spoil the quality of the tank stainless steel).
- For winter storage instructions and precautions, refer to Chapter 11.

***NOTE: It may happen that the capacity of the fresh water tank or tanks indicated on the page "Specifications" cannot be completely used depending on the trim and load of the boat.***

## GALLEY DRAINING



1. Thru-hull fitting with valve, draining of the sink
2. Thru-hull fitting with valve, draining of the draining board

## THRU-HULL FITTING



Thru-hull fitting **closed**



Thru-hull fitting **open**



## FRESH WATER SYSTEM



### PRECAUTION

- Never operate the water system equipment when the valve is closed or the tank is empty (the electrical equipment may be damaged).
- Check the water filter for condition (refer to manufacturer's instructions).
- Close the taps of empty tanks.

## GAS SYSTEM

Refer to chapter 2, "Safety".

Refer to "Fresh water and gas" diagram.





When changing the cylinder, refit the cap in place on the regulator threaded section (to avoid corrosion).

### RECOMMENDATION

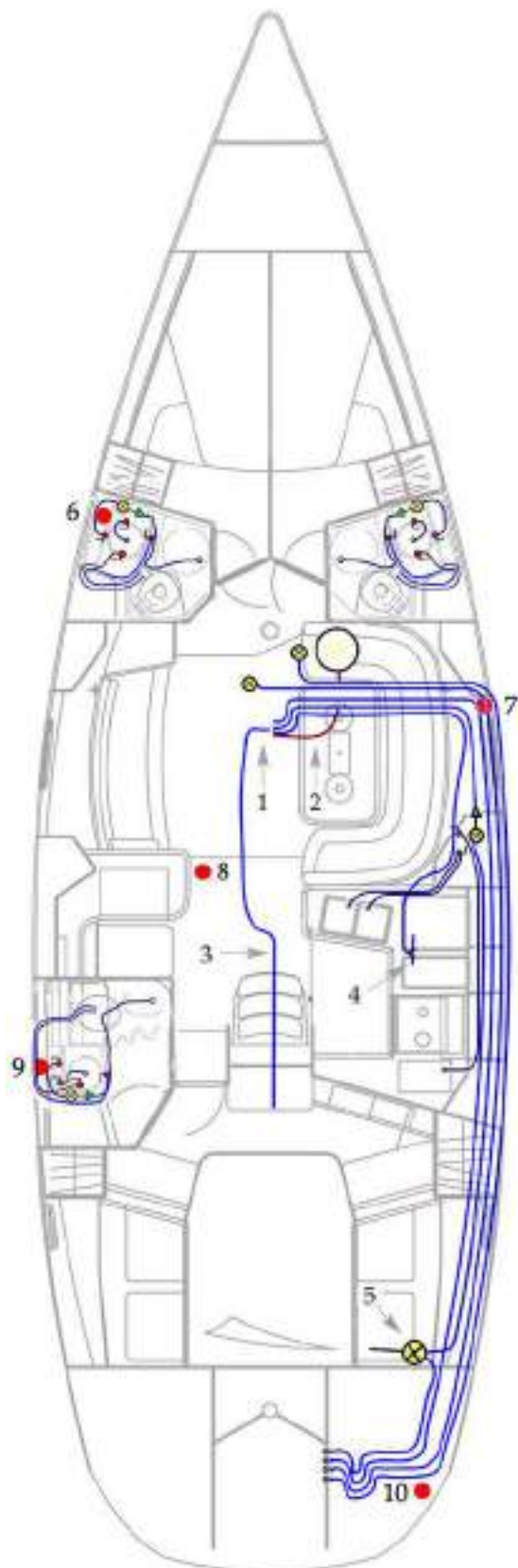
Shut off the gas safety valve and the regulator tap when the stove is not in use.

## DRAINAGE AND BILGE PUMP SYSTEM



-  Thru-hull fitting with valve
-  Electric pump
-  Water intake hose
-  Draining hose
-  Filter

1. Sump
2. Boiler draining
3. Gland drain
4. Ice box draining
5. Manual bilge pump in cockpit
6. Discharge of water from air conditioning in forward cabin (Optional extra)
7. Discharge of water from air conditioning in saloon (Optional extra)
8. Discharge of water from generating set (Optional extra)
9. Discharge of water from washing machine (Optional extra)
10. Discharge of water from aft air conditioning (Optional extra)

**NOTE:** Same position for the other layouts.

## DRAINAGE SYSTEM



Waste water from the sink, washbasins and heads is drained off by thru-hull fittings with ball valves (the valve is closed when the valve handle is perpendicular to the hose, the valve is open when the valve handle is in line with the hose).

All the floors have holes (limber holes) for the water flow.

A watertight bilge tray under the engine receives the possible oil leaks.

A main sump above the ballast collects the water coming from the boarded floor.

The main sump is partially drained by an electric or a manual pump. Regularly dry the sump with a sponge.

### MAINTENANCE

#### RECOMMENDATION

- Regularly check the valves and thru-hull fittings for proper operation and watertightness.
- Turn off the valves when the water system is not in use.
- Visually check the water pump flow.
- Check the clamps and flexible hose connections for tightness.
- Pay attention to the seals for condition.
- Regularly make sure that the strum box and bilge are perfectly clean.
- Immediately switch off the electric system in case a pump is running while all the water supplies are turned off.
- In case of a leak check the system.

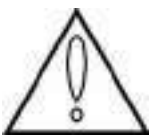

#### WARNING

The bilge pump system is not designed to provide buoyancy to the boat in case of damage. The bilge pump system is designed to drive out the water being either sea spray or leaks but absolutely not the water coming through a hole in the hull, this hole being the result of a damage.

### FORE WASHROOM

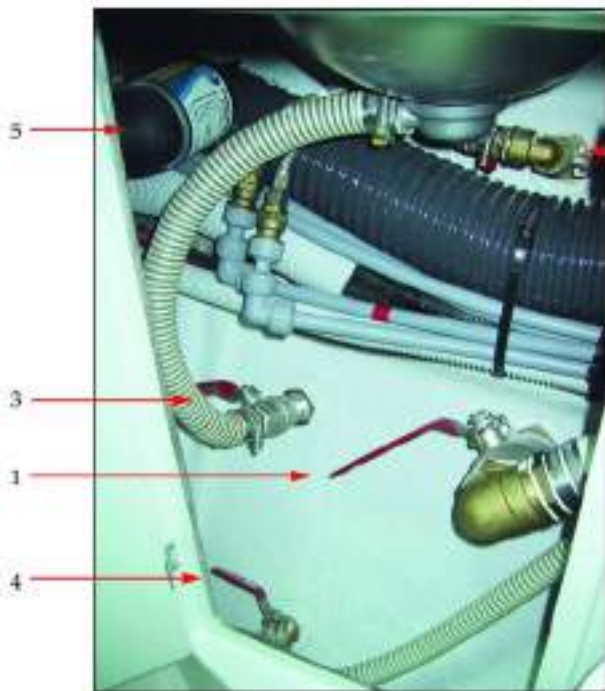

1. Thru-hull fitting with valve for heads draining
2. Thru-hull fitting with valve for shower tray draining
3. Thru-hull fitting with valve for washbasin draining
4. Thru-hull fitting with valve for heads water intake
5. Holding pump for shower tray
6. Pump filter

### AFT WASHROOM



## SANITARY APPLIANCE OPERATION



### USE OF THE MARINE HEADS

Before you use the heads, check that the water intake valve and draining valve are open.

To empty the bowl:

- Set the control lever of the pump slantwise (FLUSH).
- Operate the pump.

To dry the bowl:

- Set the lever back vertical (DRY).
- Operate the pump.

In order to avoid clogging the heads, use absorbent paper exclusively.

Schedule a regular rinsing through of the heads with fresh water.

Close the valves after each use (in particular when the boat is unattended).

### USE OF THE WASHBASINS AND SHOWERS

- Close the valves and turn off the taps after use.
- Operate the pump switch to drive the water out of the shower.

### RECOMMENDATION

When you are in a marina, use the club-house sanitary facilities (if there are).  
Since it is prohibited to discharge the waste waters in some marinas or countries, you shall use a waste holding tank (WHT).

---

## SIMPLE TANK

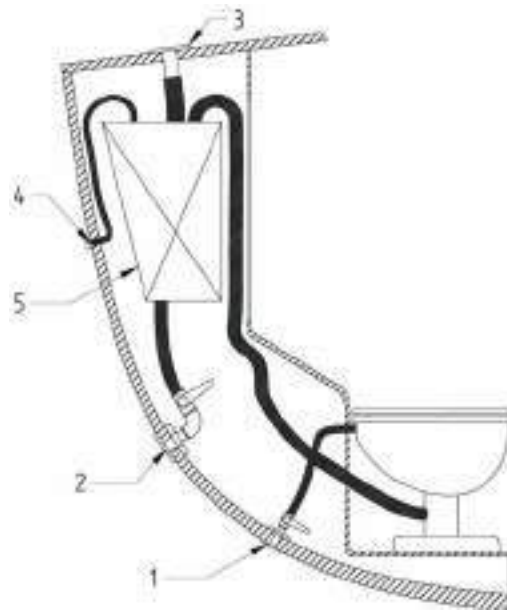

Fig. 1

## TANK EQUIPPED WITH A 3 WAY VALVE

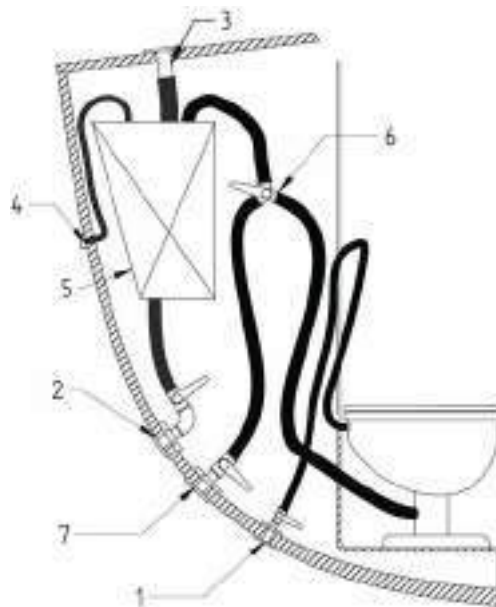
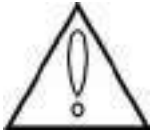

Fig. 2

1. Heads water intake hose with a thru-hull fitting and a valve
2. Tank draining hose with a thru-hull fitting and a valve
3. Heads filler
4. Tank vent hole
5. Waste holding tank (WHT) (about 45 l)
6. 3 way valve
7. Heads draining hose with thru-hull fitting and valve



## USE OF MARINE HEADS EQUIPPED WITH A WASTE HOLDING TANK (WHT) - OPTIONAL EXTRA



### WARNING

Ask for information about the laws in force in your country or your marina about discharging your waste waters into the sea.

There are two different types of WHT: The simple tanks (Fig. 1) and the tanks equipped with 3 way valves (Fig. 2).

Open the water intake valve (ref. 1) (valve handle parallel to the pipe).

In the case of a direct discharge into the sea:

- Fig. 1: Open the draining valve (ref. 2).
- Fig. 2: Close the access to the tank with the 3 way valve (ref. 6). Open the draining valve (ref. 7).

In case you store the waste waters in the tank:

- Fig. 1: Make sure the draining valve is closed (ref. 2) (valve handle perpendicular to the pipe).
- Fig. 2: Make sure the draining valves are closed (ref. 2, 7) (valve handle perpendicular to the pipe). Open the access to the tank with the 3 way valve (ref. 6).

To drain the bowl, set the control lever of the pump slantwise (FLUSH) then operate the pump.

To dry the bowl, set the lever vertical (DRY) then operate the pump.

In order to avoid clogging the heads:

- Use absorbent paper exclusively.
- Schedule a regular rinsing through of the system with fresh water.

### PRECAUTION

Close the valves after each use and above all when the boat is unattended.







To empty the tank:

- In an authorized area, open the draining valve (ref. 2).
- In a marina equipped with a system to suck the waste waters, put the sucking hose into the tank through the deck filler (ref. 3). Start the pump of the sucking system. The filler caps are opened and closed with an appropriate key. When the tank is empty, check the cap seal for condition then close the filler.

### **PRECAUTION**

Regularly check how full the tank is. High pressure due to too high a level may cause leaks or more unpleasant troubles.





# **ELECTRIC SYSTEMS**

***BATTERY SWITCH***

---

***BATTERIES***

---

***OPERATION***

---

***230 V SYSTEM***

---

***SHORE POWER***

---

***MAST HARNESS CONNECTION***

---

***ELECTRONICS***

---

***DRAWINGS AND DIAGRAMS (AT THE END OF THE CHAPTER)***

---

## BATTERY SWITCH

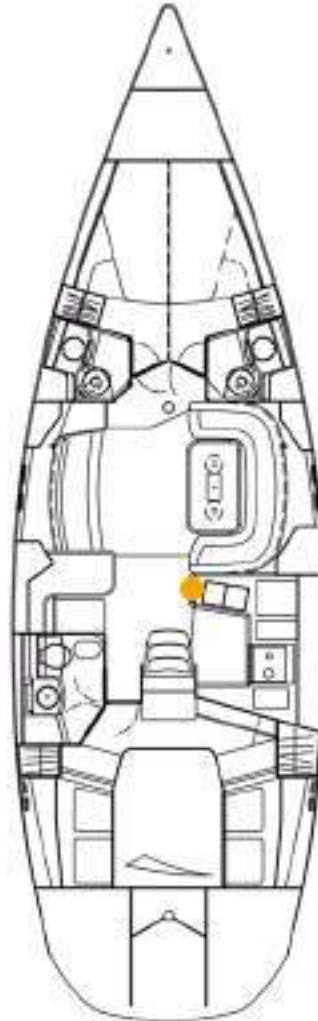

1. Optional extra
2. Battery switch + Engine
3. Battery switch -
4. Battery switch + House
5. Windlass circuit breaker

***NOTE: Same position for the other layouts.***



## BATTERY SWITCH

The electricity onboard is 12 V DC.

The electrical system consists of service batteries. The batteries supply power to all the functions on board. The engine has its own battery.

Switch on by turning the battery switches (12 V).

### PRECAUTION

Switch off all the battery switches when the boat is unattended.

## BATTERIES

The a.c. generator connected to the engine is used to charge the battery.

### PRECAUTION

Never run the engine when the circuit to charge the batteries is disconnected (it may destroy the a.c. generator).

Keep the batteries charged enough (essential to ensure them a correct service life).

The discharge of the batteries must not exceed 70 % of the rating.

Use the battery charger when in a marina in order to start sailing with properly charged batteries (optional extra).

Always check the battery and charge system condition before you put out to sea.





## MAINTENANCE

### RECOMMENDATION

- Keep the batteries clean and dry in order to avoid premature wear.
- Periodically check the electrolyte level. Add some distilled water if need be.
- Have the acidity level of the battery checked if unused for long.
- Tighten and maintain the terminal connectors lubricating them regularly with vaseline.
- Disconnect the batteries and remove them if winter stored or unused for long.

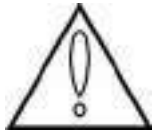

### WARNING

- Handle the batteries with care (Please refer to the manufacturer's instructions).
- In case of electrolyte splashing, thoroughly rinse the part of the body that has been in contact with it.
- Obtain medical advice.







## OPERATION

The electrical switchboard does not require any routine maintenance

### PRECAUTION

Never leave the boat unattended when the electric fitting is on (except the safety equipments directly connected to the battery and protected by a circuit breaker).

Disconnect the 230 V before you open the electric panel or cupboard.

In case an electric appliance is not energized, check:

- The main power supply (batteries, battery switches).
- The switches and circuit breakers on the line.
- the relevant electrical unit.

You can use the automatic reset switch to read the fuel gauge (to avoid electrolytic problems).



### WARNING

Never work on a live electric fitting.

### PRECAUTION

- Never modify an electric fitting and relevant diagrams yourself.
- Call in a technician skilled in marine electricity to carry out any electric modification.
- Never change the breaking capacity (amperage) of the overcurrent safety devices.
- Never install or replace the electric appliances (or any electric equipment) by components exceeding the capacity (amperage) of the circuit (Watt for bulbs).

## SHORE POWER

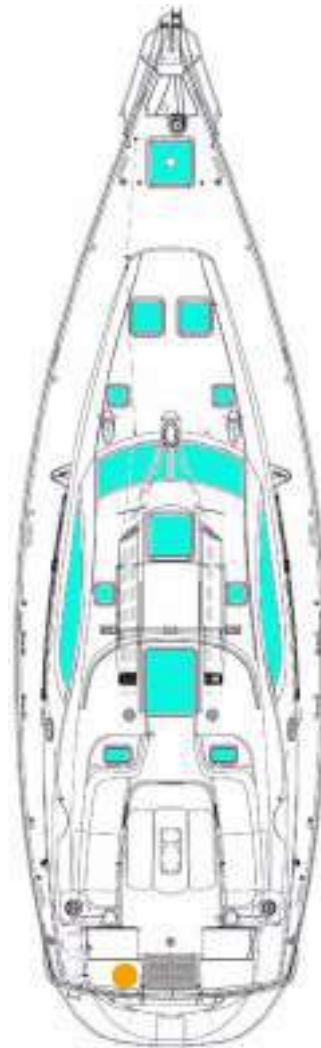



## 230 V SYSTEM

(As far as possible) use electric appliances with double insulation or with three conductors (Neutral-Live wire-Ground).

Connect the metallic covers or boxes of the electric appliances that are installed to the protective conductor of the boat (green conductor with yellow stripes).

## SHORE POWER



### DANGER

Never let the end of the boat/shore supply cable hang in the water:  
The result may be an electric field liable to hurt or kill the swimmers nearby.

### RECOMMENDATION

In order to reduce the risks of electric shock and fire:

- Before you plug in or unplug the boat/shore supply cable, switch off the shut off device connected to the shore supply.
- Plug in the boat/shore supply cable in the boat before you plug it into the shore supply socket.
- Unplug the boat/shore supply cable on shore first. Close the shore socket cover.
- Do not modify the connections of the boat/shore supply cable.

## MAST HARNESS CONNECTION

Connect the mast harness after stepping the mast.

You have access to the harness at the level of the mast, between the deck and inner moulding.

## ELECTRONICS

Wire runs are available to complete the boat equipment.

Do not install electronic instruments or repeaters less than 1,50 m away from the radio loudspeakers.





# DIESEL ENGINE

---

***FUEL TANKS***

---

***FUEL FILTER***

---

***CLOSING VALVE OF THE FUEL SYSTEM***

---

***ENGINE***

---

***VISIBILITY FROM THE STEERING STATION***

---

***INSTRUMENT PANEL / CONTROL LEVER***

---

***STUFFING BOX***

---

***PROPELLER***

---

***ANODE***

## ENGINE INSTALLATION

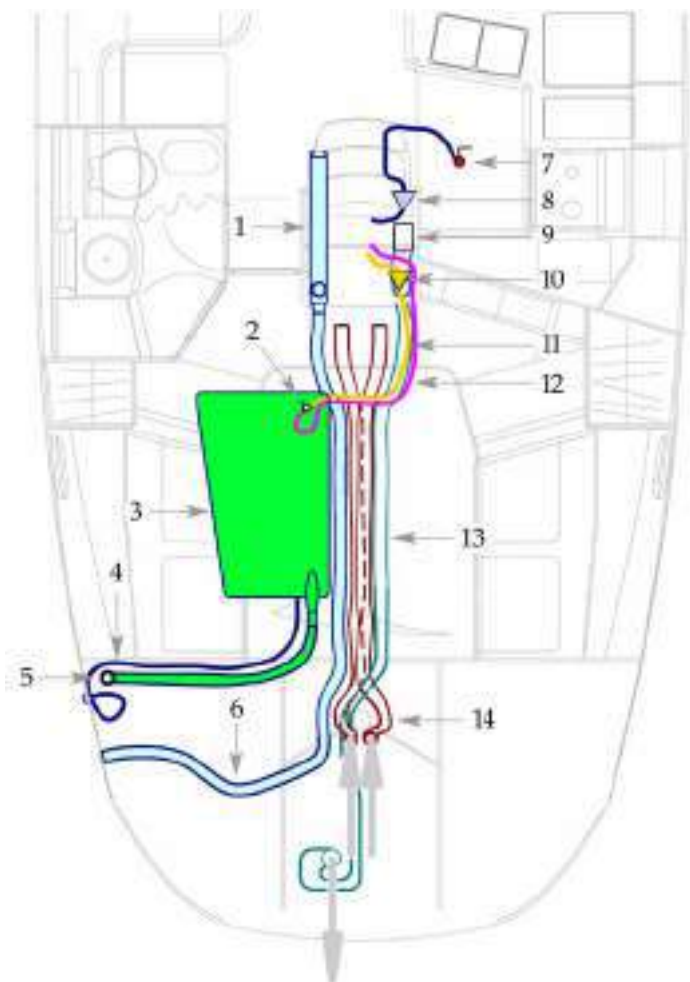

1. Silencer
2. Closing valve of the fuel system
3. Fuel tank
4. Tank vent hole
5. Fuel filler
6. Exhaust pipe
7. Sea water inlet valve for engine
8. Sea water filter
9. Extractor
10. Decanter prefilter
11. Fuel pipe
12. Fuel oil return pipe
13. Engine compartment bilge ventilation outlet
14. Engine compartment bilge ventilation inlet

**NOTE:** Same position for the other layouts.

## FUEL TANKS



### FILLING

Take the general precautions stated in chapter 7 about the water tank filling.

Fill the fuel tank using the filler. In order to protect the deck from possible fuel splash, wet the area around the filler with sea water before you remove the filler cap. In case of splashes, rinse the deck thoroughly (after fitting back the filler cap).



### DANGER

Stop the engine and refrain from smoking during fuel tank filling.

The level of fuel is transmitted to the indicator on the engine panel thanks to the dipstick.

### MAINTENANCE

#### RECOMMENDATION

- Regularly check the O ring of the filler for good condition (in order to prevent water entries).
- Do not turn off the fuel tap after each use (except in case the boat is unattended for long).
- Keep the fuel tank as full as possible (to avoid condensation).
- Every 5 years clean the tank to remove possible sludge deposition.
- Do not use chlorine-based products (they may spoil the quality of the tank stainless steel).
- Every year check the fuel system for condition (hose, valves, etc.).
- Have a professional to carry out the works on the damaged parts of the fuel system.

**NOTE:** *The capacity of the fuel tank or tanks indicated in the page "Specifications" cannot be completely used according to the trim and load of the boat. Always keep 20 % fuel as a reserve.*

## FUEL VALVE



1. Fuel oil valve for generating set
2. Fuel oil valve for engine

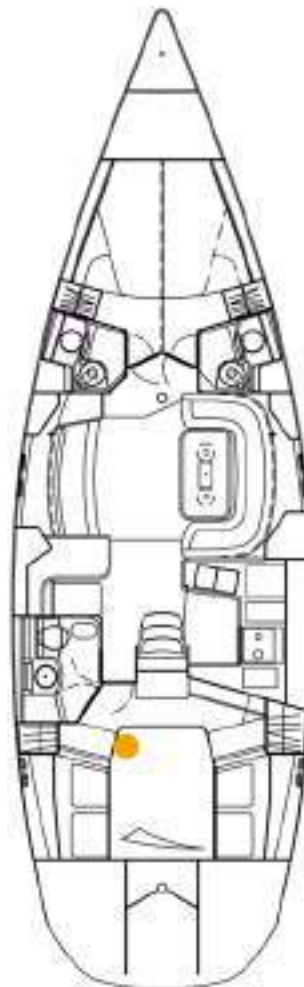

***NOTE: Same position for the other layouts.***





## FUEL FILTER

The engine running problems may have different origins, among which dirty fuel. The injection pump may wear out if there is water in the system.

The water results either from the condensation resulting from an insufficiently filled tank, or from a filler cap either not closed properly or with a damaged seal.

In order to prevent any water infiltration, the fuel runs through two filters:

- One filter is an integral part of the engine, its role is to filter fuel very finely. To know when you have to intervene and how frequently you have to change it, please refer to the engine's manual.
- The second filter is on the pipe that links the tank to the engine, it plays the role of a water decanter and prefilter.

Drain by undoing the knurled screw at the base of the decantation bowl (but not removing it).

Allow to flow into a box till the fuel looks clean.

Do it several times a year.

Change the pre-filter at least once a year (access to it when you remove the bowl).

## CLOSING VALVE OF THE FUEL SYSTEM

As for the procedures in case of fire, refer to Chapter 2.



### **DANGER**

Never obstruct the fuel valve.

## IN BOARD ENGINE



1. Filter for engine cooling water
2. Anti-siphonage bend

## ENGINE



### RECOMMENDATION

Carefully read the instructions given with your boat.

These instructions give detailed explanations on proper operation of the engine.

### PRECAUTION

Never run the engine when the boat is hauled out.

### ACCESS TO THE ENGINE

You have access to the engine via the companionway hatch.

You can check the main parts thanks to side hatches.

### PRECAUTION

Stop the engine before you open the companionway hatch and side hatches.

In case of an intervention when the engine is running:

- Stay away from belts and mobile parts.
- Be careful with full clothes, long hair, rings etc. (you may be caught).
- Wear appropriate clothes (gloves, caps etc.).

## IN BOARD ENGINE

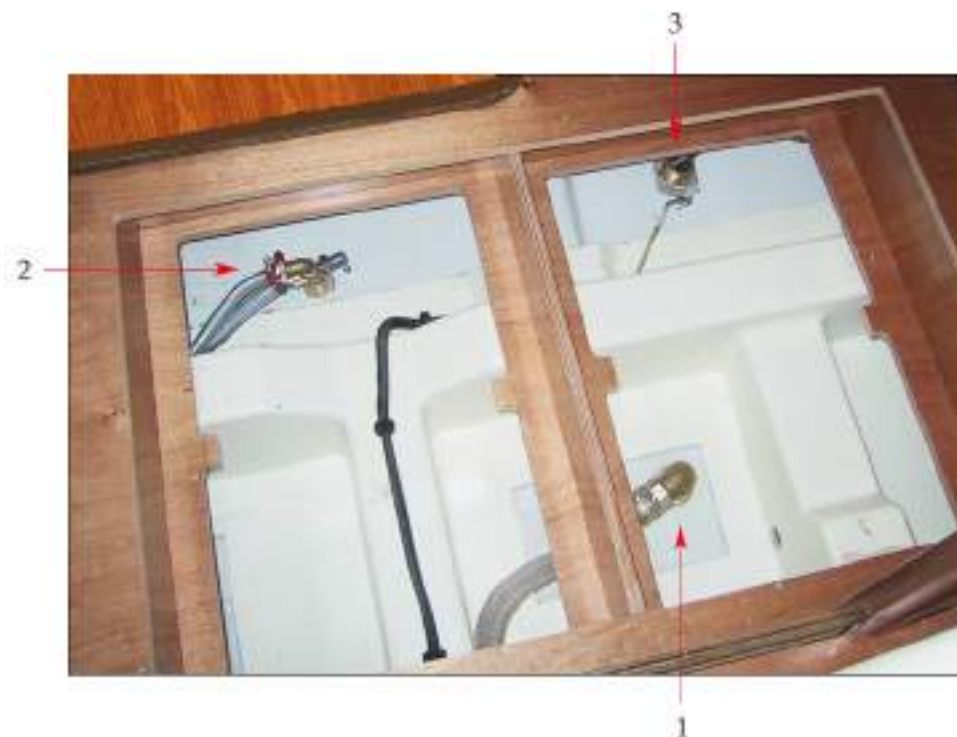

1. Thru-hull fitting with engine water inlet valve
2. 3 way valve for sea water/fresh water
3. Thru-hull fitting for fridge cooling (Optional extra)



## ENGINE WATER VALVE

The water inlet valve of the engine is essential in the engine operation.

- Keep the strainer under the hull as clean as possible.
- Brush the strainer when the boat is careened.
- Do not cover the strainer with antifouling paint.

This valve must be open before starting the engine (risk of quick damage of the exhaust muffler and of great damage of the engine).

***ADVICE: Get used to checking immediately after starting the engine if water is expelled with the exhaust gases.***

If water does not flow out:

- Stop the engine immediately.
- Check that the valve is open.

Close the water inlet valve if the boat is unattended for long.

Inspect and clean the water filter regularly.





## ENGINE OPERATION

Before starting the engine:

- Turn on the fuel valve.
- Open the valve of the engine cooling system and the valve of the stuffing box.
- Operate the battery switches and energize the electric system.
- Disengage the reverse gear (it will make the acceleration possible when in neutral).



### WARNING

Never switch off or de-energize the electric system when the engine is running. Imperatively operate the stop pull handle (or button) before using the ignition key to switch off and smother a diesel engine.

## DIESEL

- Refill before the fuel tanks have almost run dry (the fuel system may be stopped for lack of fuel).
- Make sure you have enough fuel before sailing.

## MAINTENANCE

### PRECAUTION

Refer to the manufacturer's manual given with your boat.  
Be careful with any possible risk of oil and fuel spillage.  
Check the exhaust gas colour.







## VISIBILITY FROM THE STEERING STATION

The international regulations to prevent collision at sea (COLREG) and the course regulations make mandatory a permanent and proper surveillance and the respect of priority.

Make sure there is no other boat on your way.

The visibility from the steering station may be obstructed in the following conditions:

- Load and load distribution.
- Sea conditions, rain, spray, fog or darkness.
- Lights on inside the boat.
- Persons and removable equipments in the helmsman's field of visibility.

## CONTROL PANEL/CONTROL LEVER

The instrument panel has all the testing functions of the engine and it does not require any special precaution (refer to engine leaflet).

Check the clutch and accelerator cables (lubricate the end fittings and forks).

## NAVIGATION

### RECOMMENDATION

- When the engine is running, avoid making noise and chops near the other users.
- Respect speed limits.
- When sailing, set the lever on reverse gear to lock the propeller.
- To start the engine again, reduce the speed of the boat when sailing (in order to be able to disengage the clutch before starting it again).

### STUFFING BOX



Stuffing box valve

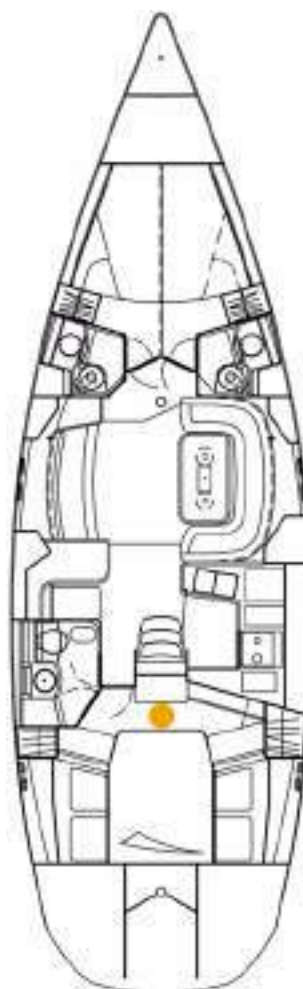

**NOTE: Same position for the other layouts.**

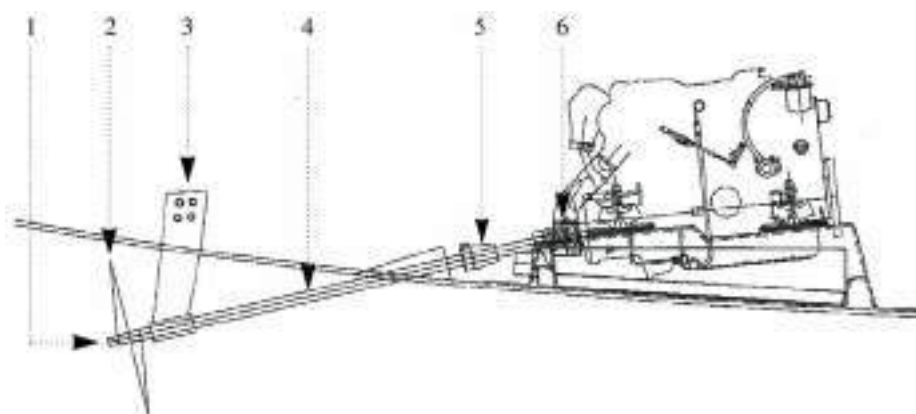

- 5. Anode
- 6. Propeller
- 7. P bracket
- 8. Propeller shaft
- 9. Stuffing box
- 10. Connecting device



## STUFFING BOX

You have access to the stuffing box through the central technical compartment behind the engine.

Lubricate the seal every 200 running hours (or at least once a year). Use 1 cm<sup>3</sup> at each lubrication.

**ADVICE: Apply the grease the manufacturer recommends in his instructions.**

After launching the boat, drive the air out from the sleeve pinching it with your fingers.

## PROPELLER

The propeller supplied as a standard with your boat is the result of tests carried out jointly with the engine manufacturer.

### PRECAUTION

Do not change the propeller without specialist's advice.

## ANODE

### RECOMMENDATION

- Check the whole propeller shaft several times a year.
- Regularly check the anode (on the driving shaft) for corrosion.
- Change the anode if necessary.
- Check and change the cutlass bearing if necessary.

## MAINTENANCE

### RECOMMENDATION

Have the whole driving and steering systems checked and maintained by a professional.  
Refer to the manufacturers' instructions supplied with your boat.





# LAUNCHING

*LAUNCHING RECOMMENDATIONS*

---

*STEPPING THE MAST*

---



## LAUNCHING RECOMMENDATIONS



A lot of skill and care is required to commission your JEANNEAU boat. The proper working of all your boat equipments in the future results from the quality of the commissioning operations.

The initial launching and the first tests of the different equipments shall be carried out by your JEANNEAU dealer or agent so you can expect to enjoy the warranty in case of some equipment failure.

If later you have to launch your boat yourself, you should take the following precautions:

### BEFORE LAUNCHING

- If your boat is to be fitted with sounder and speedometer, allow for the relevant fittings and their installation.
- Check the water intake strain box for cleanliness.
- Check the engine and reduction gear oil levels (refer to engine manual).
- Turn off the engine cooling water drain valves.
- All the optional accessories shall be sealed with paste.
- Retract the speedometer into its housing (it may be damaged by the handling belts).
- For the on-line engines, check the anode at the end of the shaft is in place. Check the nut tightening (the lock washer shall be turned over onto the nut). The anode shall not be painted.
- Turn off all the water inlet and drain valves (sink, washbasin, heads, engine).







## HOISTING

- Install a fore rope, a rear rope and fenders.
- When craning, check that no device is crushed by the belts (sounder, speedometer, shaft, etc.).
- Mark the belt position with adhesive tape on the toe rail (most of the boats are already fitted with these stickers). The belt position will be useful during the craning for a future launching.
- The crane hook will be fitted with a gantry or a spacer with two belts. The belts shall not be hooked directly on the hook, since it would result in unusual compressive stresses on the hull.
- Hoist slowly. Control the movement of the boat with ropes.



### WARNING

Do not stay on board or under the boat during hoisting.

## AFTER LAUNCHING

- Check the sounder and speedometer fittings for tightness if need be.
- Open the valves and make sure that they are tight with the hull and relevant hose.
- Check the stuffing box for watertightness (Refer to chapter 9 "Stuffing box").
- Before starting the engine, refer to chapter 9 "Engine".

## STEPPING THE MAST

Refer to chapter 5 "Rigging and Sails".





# WINTER STORAGE

*LAYING UP*

---

*PROTECTION AND MAINTENANCE*

---





## LAYING UP

- Take ashore all the ship's log, the ropes that are not used for mooring, the galley equipment, supplies, clothes, the safety equipment, batteries, the gas cylinder.
- Mark again the safety equipment, check the expiration dates, have the liferaft overhauled.
- Take advantage of this laying up to draw up a complete inventory of the equipment.

## PROTECTION AND MAINTENANCE

### INSIDE

- Drain all the fresh water pipes and rinse them with water and vinegar (do not use a chlorine based product).
- Lubricate and close all the water inlet valves and thru-hull fittings. Rinse and completely drain the heads bowls and pumps.
- Retract the sounder and speedometer sensors.
- Seal air inlets as much as you can.
- Install an atmosphere dehumidifier in the saloon and leave the cabin and storage unit doors open (lockers, ice boxes).
- Leave the cushions outside for long before putting them back into the boat in the upright and side position in order to have minimum contact surfaces.

### OUTSIDE

- Thoroughly rinse the hull and deck.
- Lubricate all the mechanical and mobile parts with vaseline (bolts, hinges, locks etc.).
- Protect all ropes and mooring lines against chafing.
- Protect the boat to the highest degree with fenders.
- Make sure the boat is properly moored.

All these recommendations do not make up an exhaustive list. Your dealer will give you the advice you need and will carry out the technical maintenance of your boat.





## ENGINE

The engine winterization shall be carried out by a professional. Depending on the boat location, afloat or ashore, winterization is different.

Here are a few major tasks to carry out:

### Afloat

- Drain the cooling system and fill it with antifreeze.
- Switch off the battery switches, lubricate the terminals with vaseline and check the battery voltage.
- Change the anode.
- Fill the fuel tanks to a maximum in order to avoid condensation.
- Please refer to the engine manual for anything relating to the engine.

### Ashore

- Take the batteries ashore and keep them on maintenance charge.
- Drain all the cooling, exhaust, oil and fuel systems.
- Carry out the winterization operations specified by the manufacturer, keeping in mind that the freeze hazard is more significant when the boat is ashore.
- Remove and lubricate the thru-hull fittings with valves of the cooling systems, leave them open and check the hoses.
- Slacken the a.c. generator and pump belts.





## Personal notes

---

---

---

---

---

---

---

---

---

---

---

---

---

---

---

---

---

---

---

---

---

---

---

---

---

---

The present document is not contractual and since we constantly desire to improve our models, we reserve the right to modify them without notice.  
Design and production: F. LUCAS - NANTES.



CHANTIERS JEANNEAU - BP 529 - 85505 LES HERBIERS cedex - FRANCE  
Tel. (33) 02 51 64 20 20 - Fax (33) 02 51 67 37 65  
Internet : [http://www.jeanneau.com\(fr\)](http://www.jeanneau.com(fr)).



JEANNEAU recommends  
**IGOL**

