

---

### 12.5.2 Cockpit shower

- The cockpit shower allows the use of fresh water for rinsing off.
- The shower is fitted with a mixer tap.

#### Operation:

- To use the shower, turn on the water by tipping the tap on its axis.
- Then press the button on the top of the shower to allow the flow of water.
- Choose the required temperature by turning the tap clockwise or anti-clockwise.
- After using the shower, it is important to turn off the water by tipping the tap on its axis.

Location: Cockpit  
hot water / cold water



Location: Foredeck  
cold water



### 12.5.3 Deck wash pump (Sea water)

- The deck wash pump is supplied by direct current.
- The deck wash pump allows the deck or the boat's tender to be washed.
- The deck washer pump control switch is situated inside the wheelhouse.

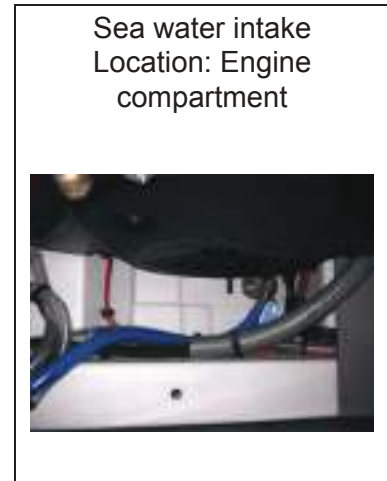
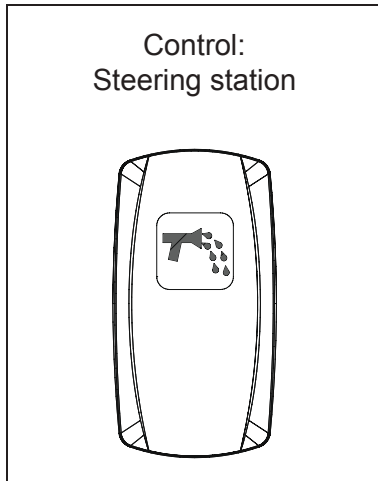



#### Operation

- Open the sea water intake valve.
- Attach a hose to the connector provided in the cockpit.
- Start the pump.

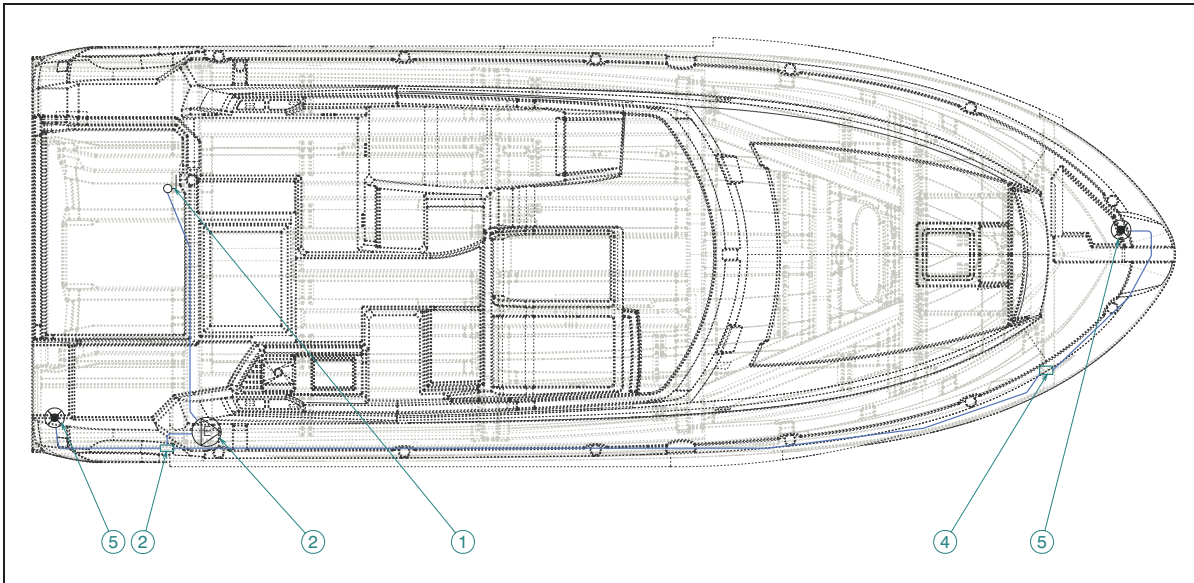

## Diagram of the layout - Deck wash pump



	Pipe - Sea water (20 mm diameter)
---	-----------------------------------

Reference	Designation
1	Sea water intake
2	Deck wash pump + Filter
3	Connector
4	Wire passage
5	Connection

### 12.5.4 Shore freshwater supply

- The shore fresh water supply arrives directly into the fresh water plumbing system via the water unit, without passing through the tanks.
- A non-return valve in the distribution circuit allows the shore supply water to be used without opening the valve.
- **Disconnect shore water supply before leaving the boat.**



### 12.5.5 Water heater

- The water heater allows the use of hot water on board the boat.
- The water heater operates by recovering heat from the starboard engine cooling circuit or by means of the boat's AC electrical circuit.
- The water heater thermostat regulates the water temperature only when it is operating with electrical resistance. The thermostat is pre-set in the factory.
- The mixer tap allows the temperature leaving the water heater to be adjusted.
- Never switch on the water heater if it is not filled with water.
- A valve allows the water heater to be connected to the heat exchanger. This valve allows you to isolate a faulty circuit.

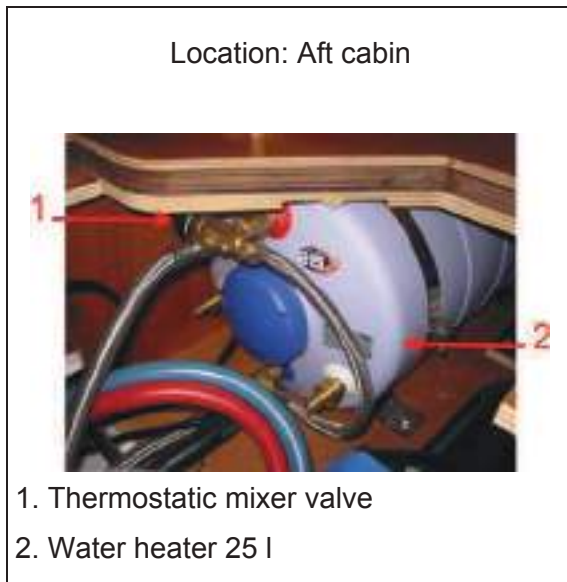

---

## 12.5.6 Ice maker (Ice maker)

### General points

- The ice maker provides a supply of ice from the onboard water system.
- The ice maker runs on the AC power supply.
- A circuit-breaker protects the circuit.

### Operation

- The ice maker is supplied with water from the tanks via a supply valve.
- Turn on the water unit to supply the ice maker.
- Open the supply valve onboard water / ice maker.
- Turn on the AC power (shore or generator) and actuate the ice maker circuit-breaker.
- Start the ice maker using the control on the appliance.

### Maintenance

- A carbon filter is installed in the ice maker water system. Change the filter regularly.
- Clean the evaporator with a damp cloth at least once a year. Never use cleaners which are abrasive, acid or which contain solvents for cleaning the evaporator.
- Clean the hinge of the ice maker door regularly with a damp cloth.
- Clean and defrost the ice maker regularly.
- During overwintering, leave the ice maker door open to avoid mould and odour formation.
- During prolonged absences, drain the ice maker system to avoid damage caused by freezing.



- Refer to the manufacturer's instructions for use and maintenance.
- Never heat or use tools to defrost the inside of the fridge more quickly.
- Never obstruct the heat exchanger of the fridge.



## 12.6 BLACK WATER SYSTEM (WC)

### General points

- Black water is human waste including the flushing water from the toilets.
- Close the valves after each use and above all when the boat is unattended.
- Regularly check the valves and thru-hull seacocks for proper operation and watertightness.
- Regularly check the tightness of the flexible pipe clamps and connections.



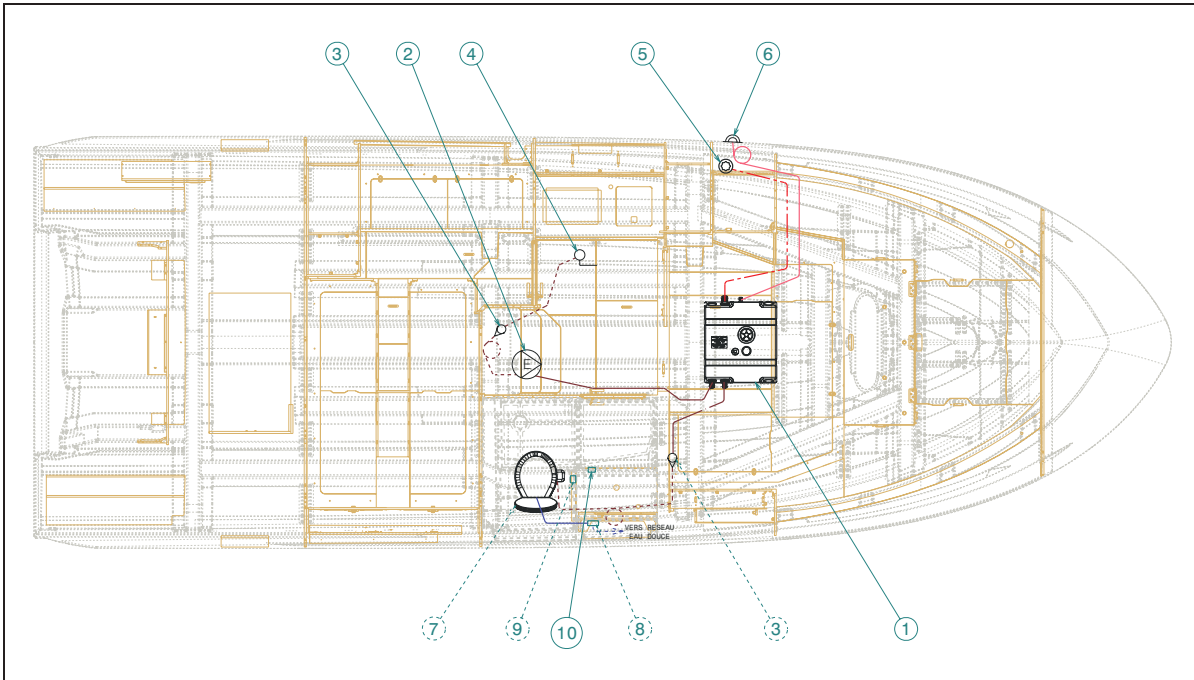



### 12.6.1 Location diagram of black water system

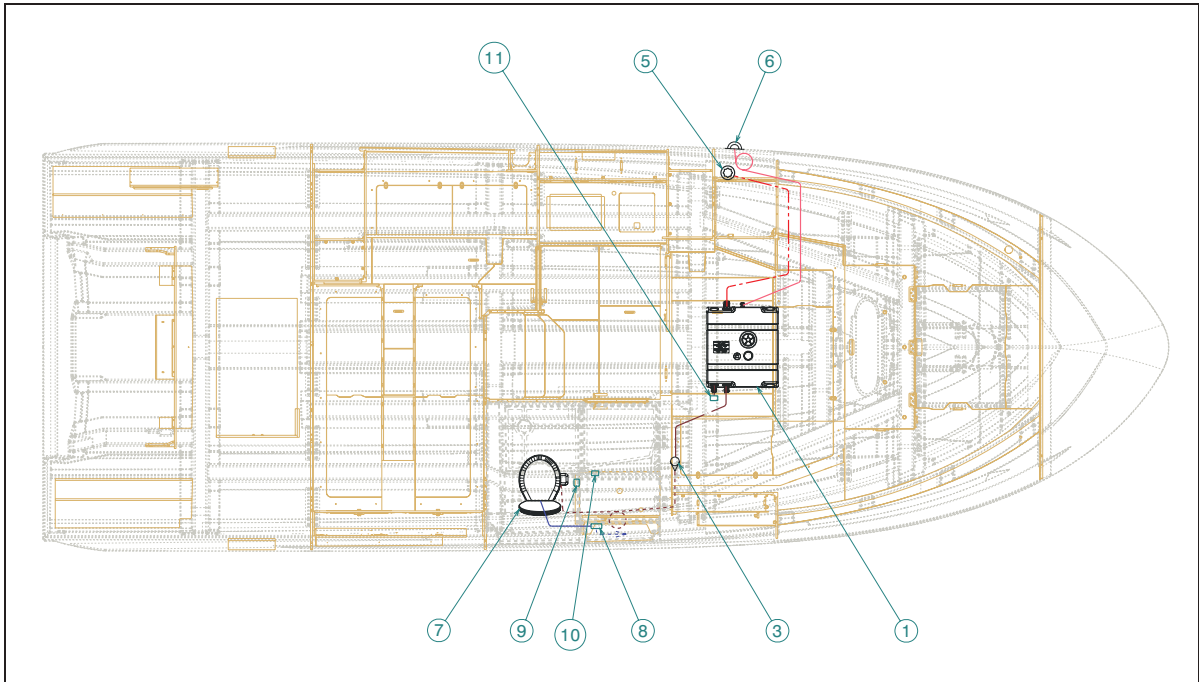

	Supply pipe - Fresh water (12 mm diameter)
	Supply pipe - Fresh water (19 mm diameter)
	Pipe - Vent hole (25 mm diameter)
	Draining hose (25 mm diameter)
	Draining hose (38 mm diameter)
	Pipe - Intake (38 mm diameter)
	Pipe - Intake (50 mm diameter)

Reference	Designation
1	Black water tank
2	Masher (Pump - WC evacuation to sea)
3	Non-return valve
4	WC evacuation to sea
5	'WASTE' pump out drain plug (WC evacuation - Deck)
6	Black water tank
7	Electric toilet
8	Electromagnetic valve
9	Control - WC
10	Black water tank gauge



	Supply pipe - Fresh water (12 mm diameter)
	Supply pipe - Fresh water (19 mm diameter)
	Pipe - Vent hole (25 mm diameter)
	Draining hose (25 mm diameter)
	Draining hose (38 mm diameter)
	Pipe - Intake (38 mm diameter)
	Pipe - Intake (50 mm diameter)

Reference	Designation
1	Black water tank
3	Non-return valve
5	'WASTE' pump out drain plug (WC evacuation - Deck)
6	Black water tank
7	Electric toilet
8	Electromagnetic valve
9	Control - WC
10	Black water tank gauge
11	Cap



---

## YOUR BOAT IS FITTED WITH A BLACK WATER TANK

To minimise the smells coming from this tank, we advise the following use and maintenance:

### 1) Holding tank

- A black water tank is used solely for the temporary collection of water coming from the toilets.
- The tank can be emptied in 2 ways:
  - By connection to a pumping system that empties the tank by suction. This system uses the 'WASTE' deck connection.
  - Via the thru-hull fitting emptying directly into the sea (on condition that this is allowed by law in the country where the boat is sailing).
- Only use water soluble toilet paper to avoid any blockage.

*Note: Sanitary towels and other items (paper handkerchiefs, dressings etc) in the toilets and black water tank will inevitably lead to blockages.*

- Faecal matter causes formation of unpleasant odours in the black water tanks, to which the use of salt water for flushing the toilets also contributes. Algae present in salt water also give off unpleasant odours.
- Completely empty the black water system before leaving the vessel unattended in temperatures below freezing.
- Ask for information about the laws in force in your country or your marina about discharging your waste waters into the sea.

### 2) Use of toilets

- Every time the toilets are used, flush afterwards with copious amounts of water in the bowl using the toilet pump (manual or electric).
- When you are leaving the boat for several days, flush with fresh water, using for example the head's shower. Sea water that stagnates in the bowl gives off bad smells.

3) Maintenance of black water tank



- The risk of unpleasant odours forming increases when the waste water remains in the tank for a long time.
- Whenever possible empty the tank regularly even before it is full.
- Every time the tank is emptied put in about 5 litres of fresh water and add an appropriate detergent additive (available from chandleries). A very simple method is soda salts, which clean and disinfect at the same time.
- Before winterising, flush the tank with copious amounts of fresh water filling it through the 'WASTE' deck connection. Leave at least 5 litres of fresh water mixed with a detergent additive.
- Disinfecting: Disinfect the tank once a year by filling it with a solution of Javel water (1 to 1000).



- Never use automobile anti-freeze in the black water system: risk of poisoning.

**ADVICE-RECOMMENDATION**

- Respect local regulations regarding the emptying of black water tanks.

<p>Location: Forward cabin</p> <p>Black water tank Capacity: 80 litre</p> 	<p>Masher Location: Aft cabin</p> 	<p>WC evacuation to sea (Thru-hull fitting) Location: Saloon</p> 
---	--	--



1. Black water tank gauge

2. Control - WC evacuation to sea

*Note: The valve must be opened before starting the pump.*

**Drainage by electric pump DC (Masher)**

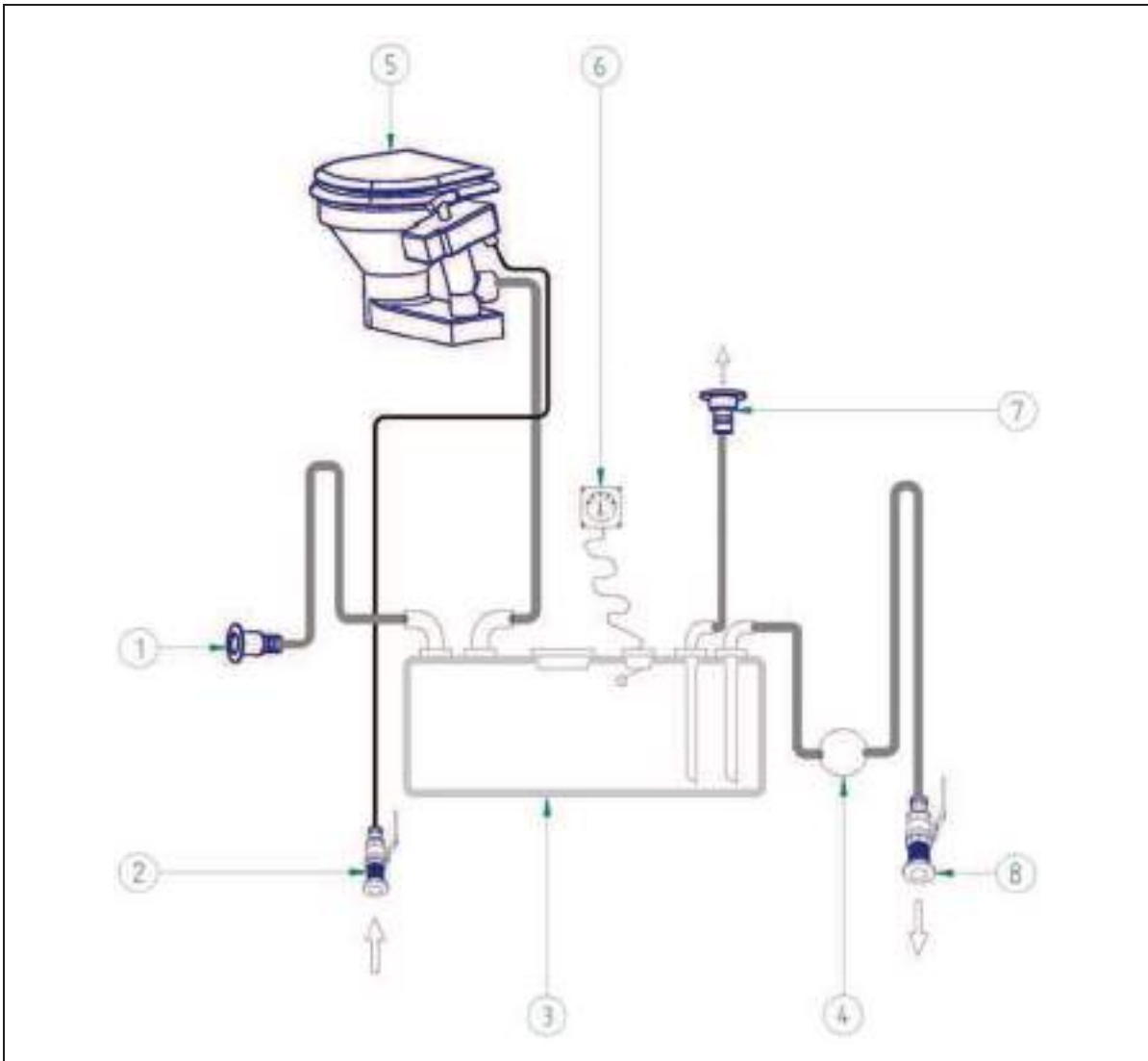

Reference	Designation
1	Vent hole
2	Seawater intake valve
3	Black water tank
4	Masher (WC drainage pump)
5	WC
6	Gauge
7	'WASTE' deck connection
8	Sea discharge valve

**Using a marine toilet with a tank drain by macerator**

- I. Open the sea water intake valve (Ref 2).
- II. Fill the bowl by using the manual toilet pump.
- III. Using the toilet (Ref 5).
- IV.a. To empty the organic waste in the tank:
  - Make sure the thru-hull seacock (Ref 8) is closed.
  - Empty the bowl using the manual toilet pump.
- IV.b. In the case of a direct discharge into the sea:
  - Open the thru-hull seacock (Ref 8).
  - Empty the bowl using the manual toilet pump.
  - Empty the tank by switching the electric pump (Ref 4).
- IV.c. To discharge through the deck:
  - Open the deck connection marked 'WASTE' (Ref 7).
  - Use the pump-out system where fitted at a port.

Electromagnetic valve  
Location: Head



---

### **Use of a DC electric toilet has a tank-discharge macerator**

- I. Open the sea water intake valve (Ref 2).
- II. Fill the bowl by pressing the fill button.
- III. Using the toilet (Ref 5).
- IV.a. To empty the organic waste in the tank:
  - Make sure the thru-hull seacock (Ref 8) is closed.
  - Empty the bowl by pressing the empty button.
- IV.b. In the case of a direct discharge into the sea:
  - Open the thru-hull seacock (Ref 8).
  - Empty the bowl by pressing the empty button.
  - Empty the tank by switching the electric pump (Ref 4).
- IV.c. To discharge through the deck:
  - Open the deck connection marked 'WASTE' (Ref 7).
  - Use the pump-out system where fitted at a port.



Refer to the manufacturer's instructions for use and maintenance.



## 12.7 WASTE WATER SYSTEM

### General points



- The waste water system is the water coming from the sink, showers, air conditioning drains and washbasins.
- Close the valves after each use and above all when the boat is unattended.
- Regularly check the valves and thru-hull seacocks for proper operation and watertightness.
- Regularly check the tightness of the flexible pipe clamps and connections.

### **ADVICE-RECOMMENDATION**

- Observe local regulations regarding the emptying of grey water tanks.

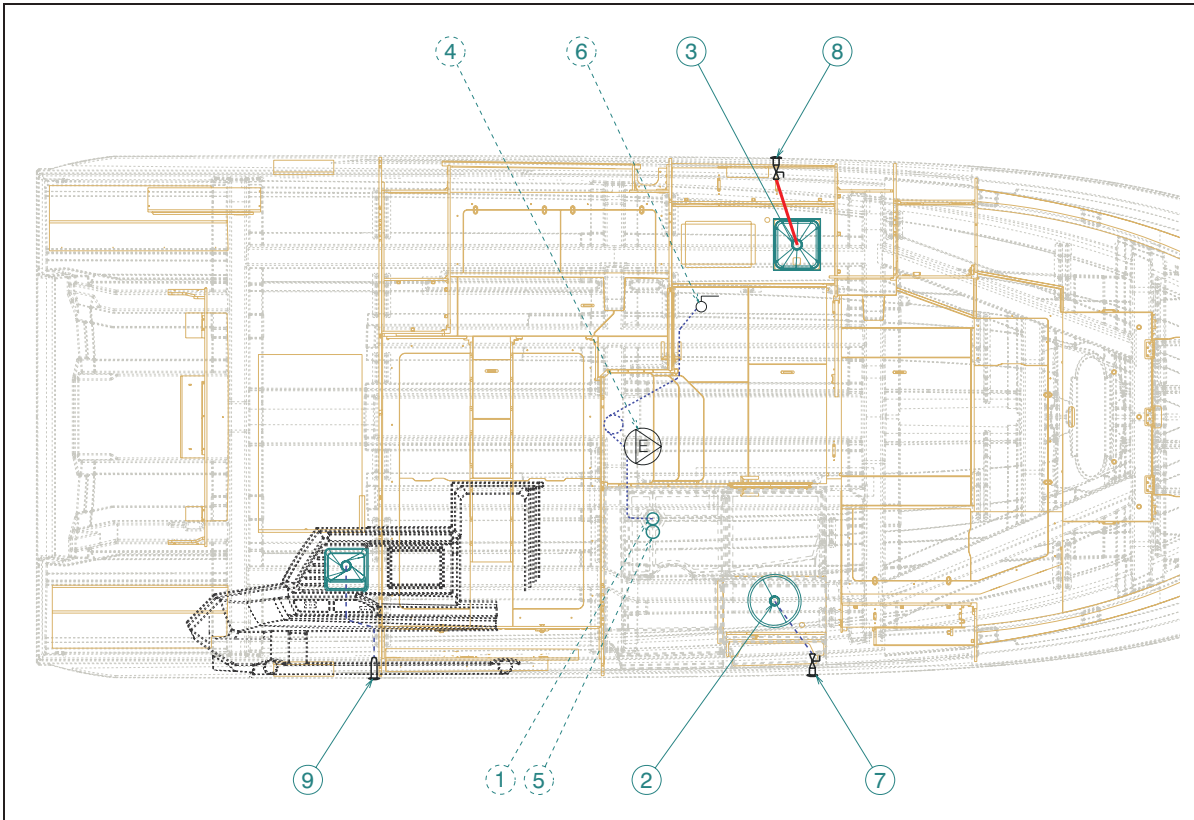
## Layout diagram waste water



	Pipe - Waste water (20 mm diameter)
	Pipe - Waste water (25 mm diameter)
	Pipe - Waste water (40 mm diameter)



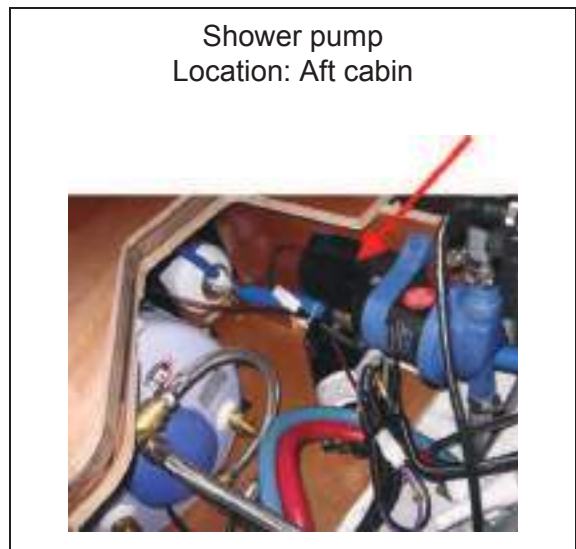
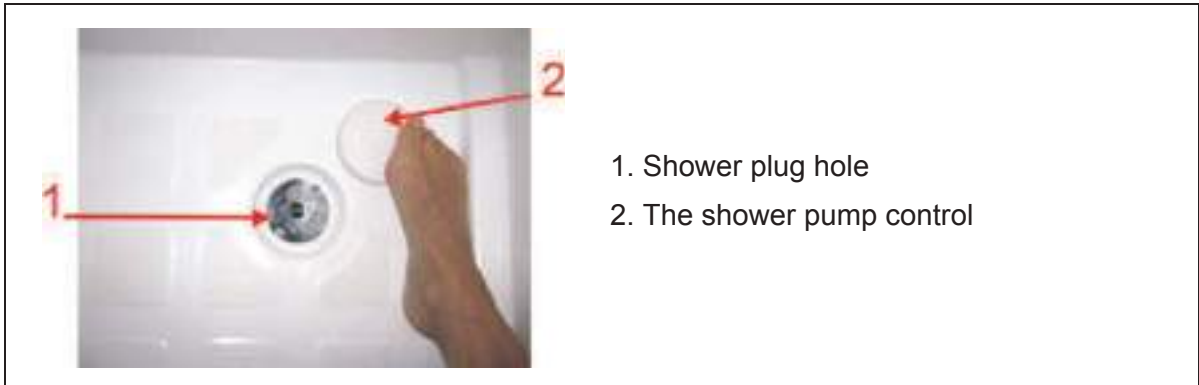

Reference	Designation
1	Shower plug hole
2	Washbasin drain plug
3	Sink plug hole
4	Draining pump for shower
5	Control - Shower pump
6	Shower draining
7	Washbasin draining
8	Sink draining
9	Sink draining - Cockpit



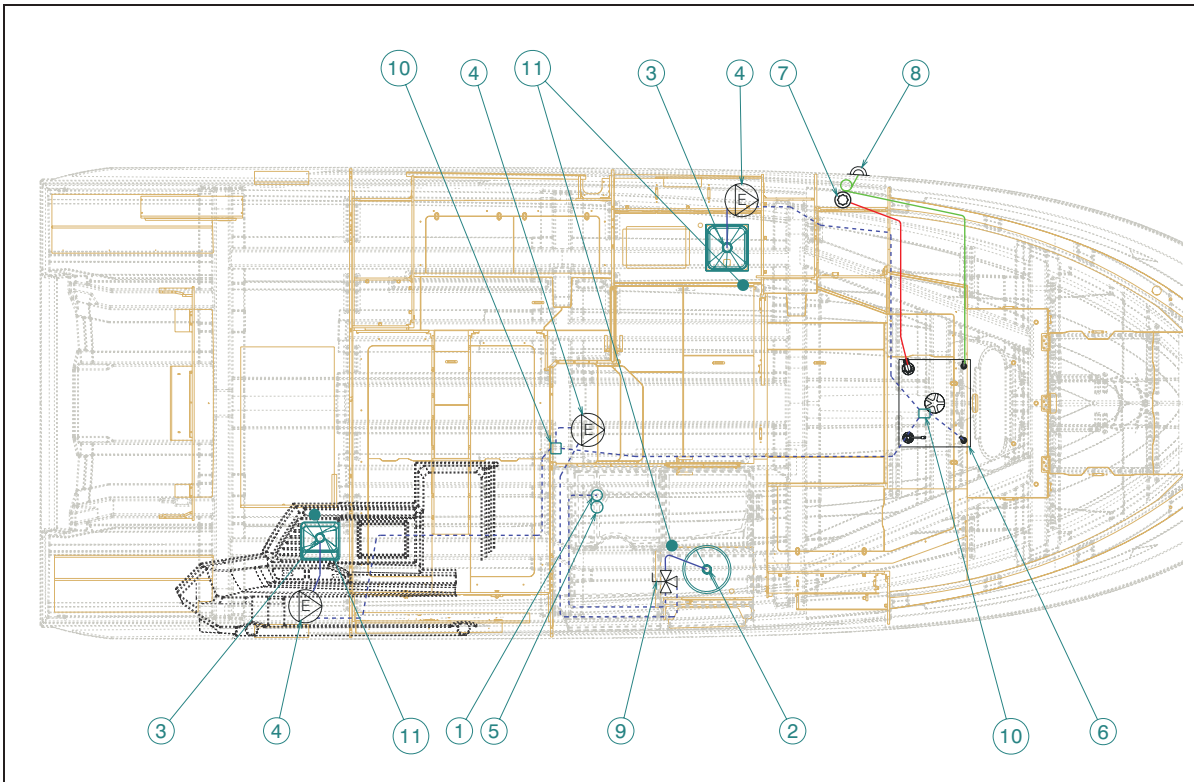

specification for SWITZERLAND



	Pipe - Vent hole (20 mm diameter)
	Pipe - Waste water (20 mm diameter)
	Pipe - Waste water (25 mm diameter)
	Pipe - Intake (40 mm diameter)

Reference	Designation
1	Shower plug hole
2	Washbasin drain plug
3	Sink plug hole
4	Draining pump for shower
5	Control - Shower pump
6	Waste water tank
7	'WASTE' pump out drain plug
8	Waste water tank vent
9	Selection valve
10	Join at Y
11	Switch - Pump

## 13 ENGINE

### 13.1 INFORMATION ABOUT THE RISKS OF FIRE AND OF EXPLOSION OF ENGINES

- Make sure that the coolant is circulating properly.
- Ensure that the engine compartment ventilation air inlets are kept clear.
- Stop the engine and refrain from smoking during fuel tank filling.
- Get your fuel circuit checked regularly by a professional engineer.
- Avoid any contact between inflammable materials and the hot sections of the engine.
- Never switch off or de-energise the electric system when the engine is running.
- Never block the access of the fuel supply valve.
- Do not obstruct or modify the ventilation system.
- Never turn the engine over when the boat is on land.
- Fuel stored outside the fuel tanks (jerrycans, spare cans) must be kept in a well-ventilated place.
- Regularly check that the engine compartment is clean and dry.

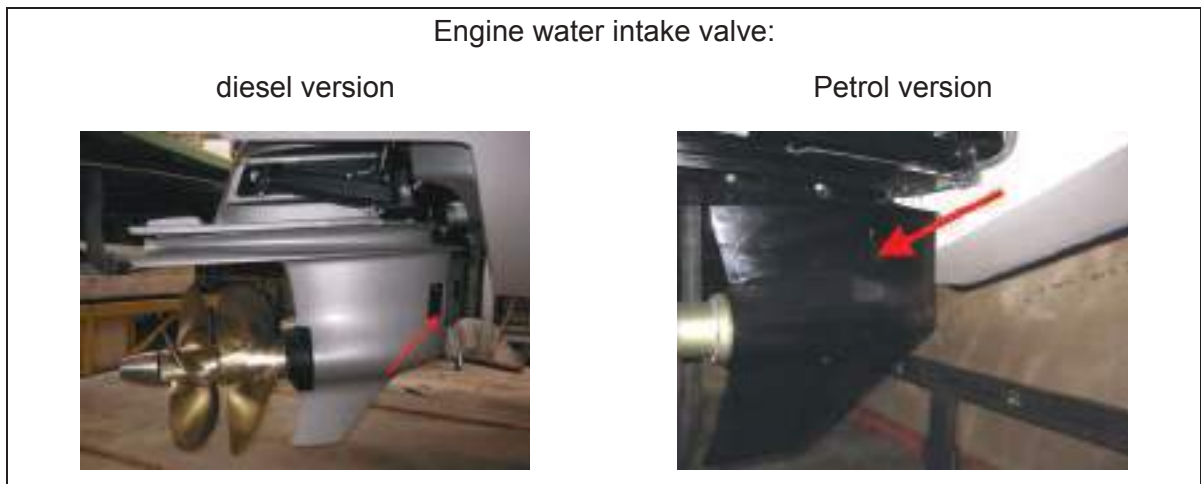

---

Fuel supply valve



Remote shut-off pull handle  
Location: Aft cabin



### **Petrol engine specialities**

Operate (symbol 1) the fan for 4 min (symbol 2) before starting the engine (symbol 3).





### 13.2 DANGER FROM MOVING MECHANICAL PARTS

- Keep away from the moving parts of the engine (belts and moving parts or hot components) and the drive shafts etc..
- Be careful if you have long hair, bulky clothing, rings etc (at risk of being caught).

### 13.3 GENERAL POINTS

- Don't install an engine more powerful or heavier than recommended on this boat, this risks compromising the boat's stability.
- Make sure you have enough fuel before sailing.
- Stop the engine before opening the engine compartment.
- Don't close the fuel supply valve between each use of the engine (unless for a lengthy absence).
- Get the whole propulsion system checked at least once a year by a professional engineer. see the chapter on "Manoeuvrability".

#### Type of motorisation

Your boat is fitted with two in-board diesel engines (Diesel version).

Your boat is fitted with two in-board petrol engines (Petrol version).

Transmission type is: Z-drive.

#### Filling up with fuel

- Fill the fuel tank using the 'PETROL/DIESEL' deck filler provided for this.
- Reservoir location: Engine compartment
- Regularly check that the O ring on the filler cap is in good condition, to prevent any water ingress.
- Each fuel supply valve supplies one engine.
- The generator has its own fuel supply valve.

---

## Gauge

- The level of fuel is transmitted to the indicator on the wheelhouse thanks to the dipstick.
- Some of the gauges must be calibrated when you first fill the tanks: please consult your dealer.

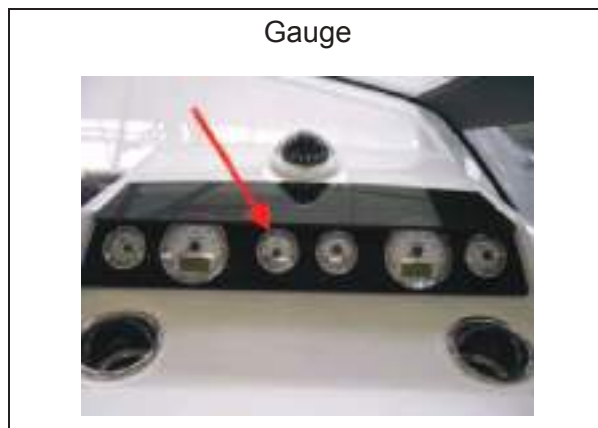

- The tanks' nominal capacity cannot be fully used due to the load and the need to maintain the correct trim. A 20% reserve should be kept.

### **ADVICE-RECOMMENDATION**

- Regularly check that the O ring on the filler cap is in good condition, to prevent any water ingress.
- Keep the fuel tank as full as possible to prevent condensation.
- Be careful with any possible risk of oil and fuel spillage.
- Follow the engine manufacturer's instructions exactly.
- **Never switch off the battery breakers when the boat's engine is running (risk of serious damage to the charging circuit).**

EPA version (United States Environmental Protection Agency)

- The maintenance of the complete petrol circuit system must be done professionally every year. It is advisable to clean the circuit only with soapy water. All the fuel circuit connections must be checked once a year.
- When cleaning the boat, be careful not to damage the valves, vent or fuel circuit filler.

**INSTALLATION CONFIGURATION FOR EACH FUEL TANK (STANDARDS EPA)**

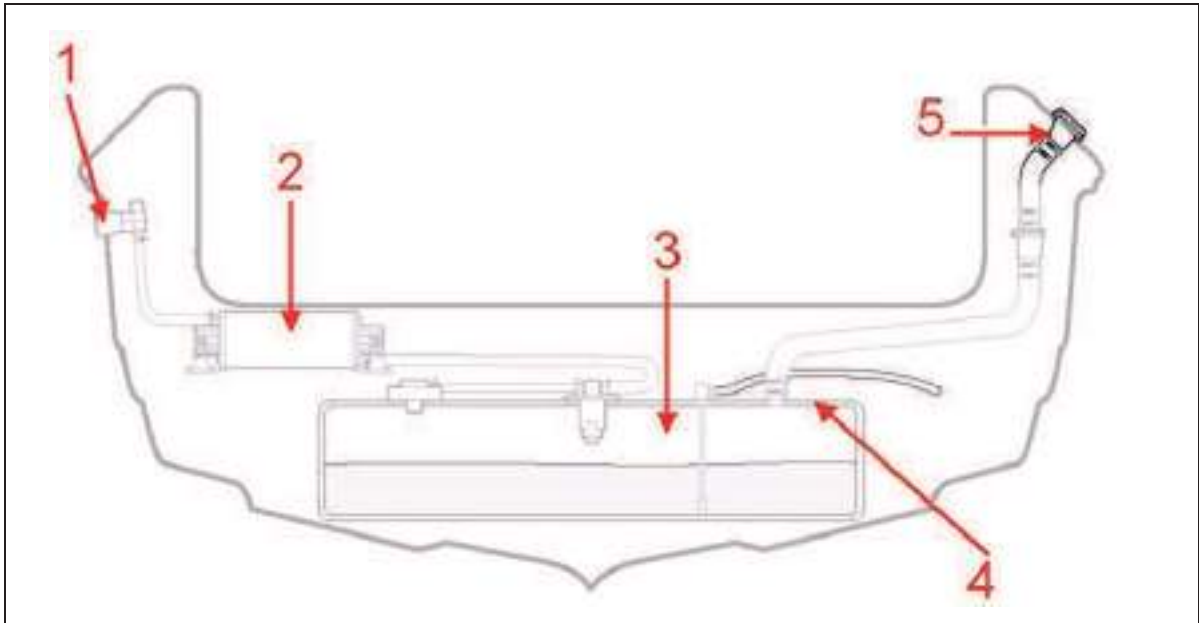

Reference	Designation
1	Vent hole
2	Canister
3	Petrol tank
4	Fuel supply valve
5	Deck filler

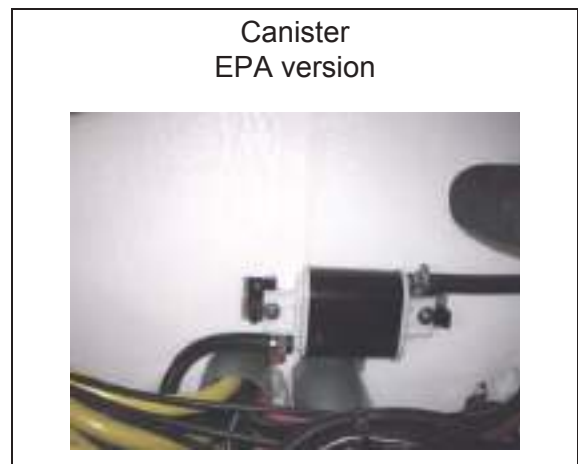

---

## 13.4 STARTING THE ENGINE

Before starting the engine, it is imperative:

- to open the fuel supply valve;
- to switch on the battery supply by using the battery isolator switches;
- to put the control lever in neutral;

Make a habit of looking to see if sea water is pumped out with the exhaust gases as soon as you start the engine. If no water runs out, stop the engine immediately. Check the coolant flow.

As soon as the engine starts, the engine compartment bilge fan operates (diesel version).



- Before using the engine, make sure you carefully read the handbook provided by the engine manufacturer.



- Always start the engine with the control lever in neutral.
- Learn how to judge the necessary distance of deceleration for the vessel to come to a complete stop (The reverse gear is not a brake).

### 13.5 ENGINE WATER INTAKE VALVE

- Keep the strainer under the hull as clean as possible;
- Brush the strainer whenever the boat is lifted out;
- Don't cover the strainer in antifoul.

A sea water filter filters the water before it goes through the heat exchanger (diesel version - only).

Regularly inspect the sea water filter and clean it if necessary. Screw/unscrew the cover of the filter by hand (never use tools for this).

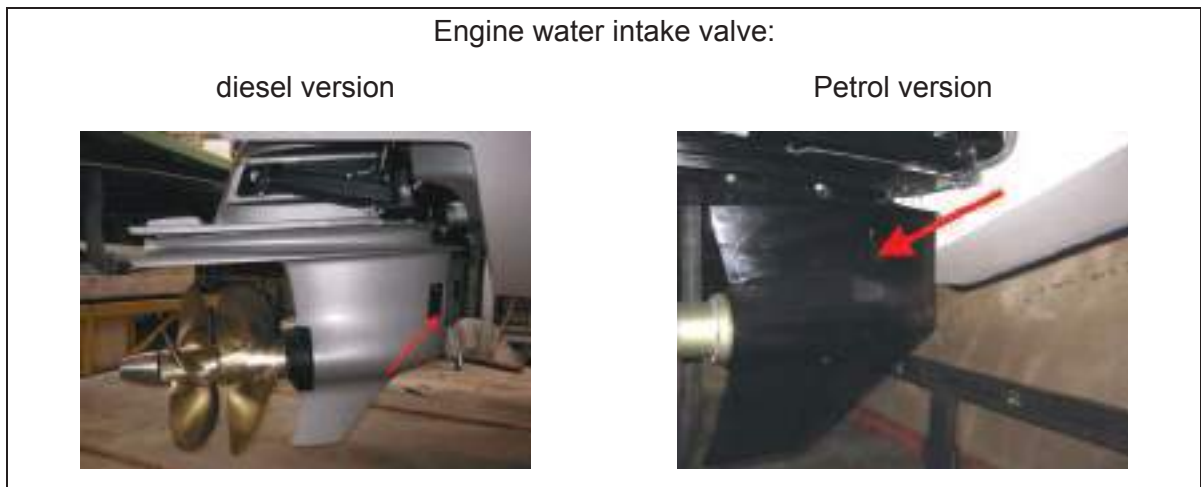



---

### 13.6 FUEL FILTER (DIESEL VERSION - ONLY)

Engine running problems may have different origins, including dirty fuel. The injection pump may wear out if there is water in the system. The water results either from the condensation resulting from an insufficiently filled tank, or from a filler cap either not closed properly or with a damaged seal.

In order to prevent any water infiltration, the fuel runs through two filters:

- One filter is an integral part of the engine, its role is to filter fuel very finely. Please refer to the engine manufacturer's notes for any maintenance and for the frequency of filter changes.
- The second filter is on the pipe that links the tank to the engine, it plays the role of a water decanter and prefilter.

#### Maintenance

- Purge the impurities by unscrewing the screw located at the base of the decanting bowl (without removing it). Let the liquid run into a receptacle until the fuel runs clear. Do this several times a year.
- Change the pre-filter at least once a year.

