

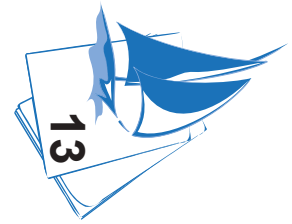





- 161 -



WATER SYSTEMS

	Connectors
	Coldwater system - 19 mm diameter
	Hot water system - 19 mm diameter
	Coldwater system - 12 mm diameter
	Hot water system - 12 mm diameter

Reference	Designation
1	Water heater
2	Water unit
3	Galley sink
4	Washbasin - Head version
5	Shower
6	Spout (Foot pump)
7	Foot pump
8	Electromagnetic valve - WC
9	Valve to select tank
10	Cockpit shower
11	Fresh water shore supply
12	Non-return valve

13.5 MAIN PLUMBING EQUIPMENT

13.5.1 Water unit

- The water unit is supplied by direct current.
- It serves to feed all the boat's plumbing equipment with fresh water. It is fitted with a pressure switch that activates the flow when the pressure in the water system falls.
- The water unit must only be used with the fresh water supply. All other use (with sea water or bilge water, with oil products) is prohibited.
- Make sure that the water unit is never run dry.
- The pressure and capacity of the water unit depend on the temperature of the stored fresh water supply.

Control: Electrical panel.

Location: Engine compartment



13.5.2 Cockpit shower

- The cockpit shower allows the use of fresh water for rinsing off.
- The shower is fitted with a mixer tap.

The tap has a dual function:

- It allows the water to be turned on/off ;
- It allows a choice of water temperature (hot water / Cold water).

Operation:

To use the shower, turn on the water by tipping the tap on its axis.

Then press the button on the top of the shower to allow the flow of water.

Choose the required temperature by turning the tap clockwise or anti-clockwise.

After using the shower, it is important to turn off the water by tipping the tap on its axis.

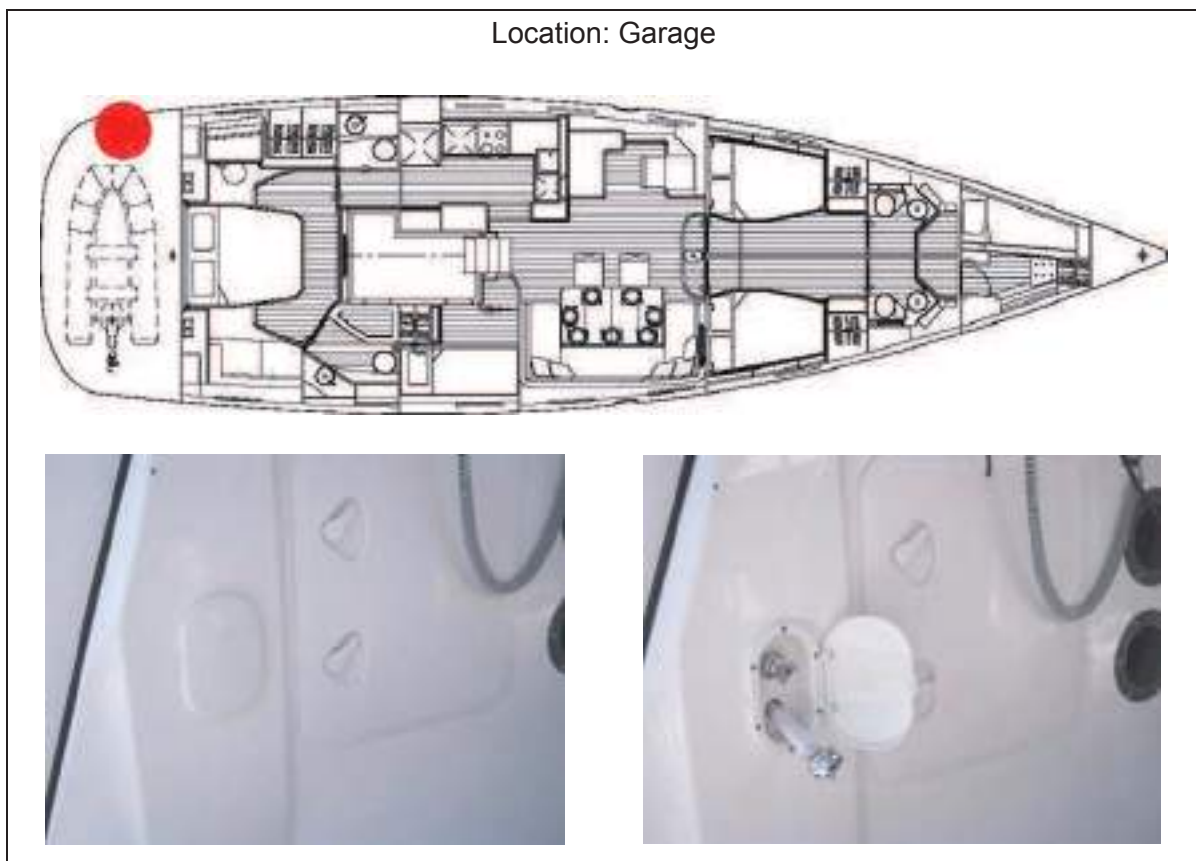

13.5.3 Deck wash pump (sea water/fresh water)

- The deck wash pump is supplied by direct current.
- The deck wash pump allows the deck or the boat's tender to be washed.
- The deck wash pump is switched on at the electric panel.
- Siting of the sea water/fresh water selector valve: Skipper's cabin.

Operation

- Open the sea water intake valve.
- Select sea water/fresh water supply.
- Attach a hose to the connector provided in the cockpit.
- Start the pump.



Sea water intake
Location: Skipper's cabin



Deck wash pump
Location: Skipper's cabin

1. Deck wash pump
2. Sea water filter



13.5.4 Shore freshwater supply

- The shore fresh water supply arrives directly into the fresh water plumbing system via the water unit, without passing through the tanks.
- A non-return valve in the distribution circuit allows the shore supply water to be used without opening the valve.
- The shore water supply connection is located in the cockpit.
- **Disconnect shore water supply before leaving the boat.**

Location: Cockpit



13.5.5 Seawater foot pump

- The foot pump allows fresh water to be used without the need for power..
- Water from the foot pump comes out at the spout located at the sink.

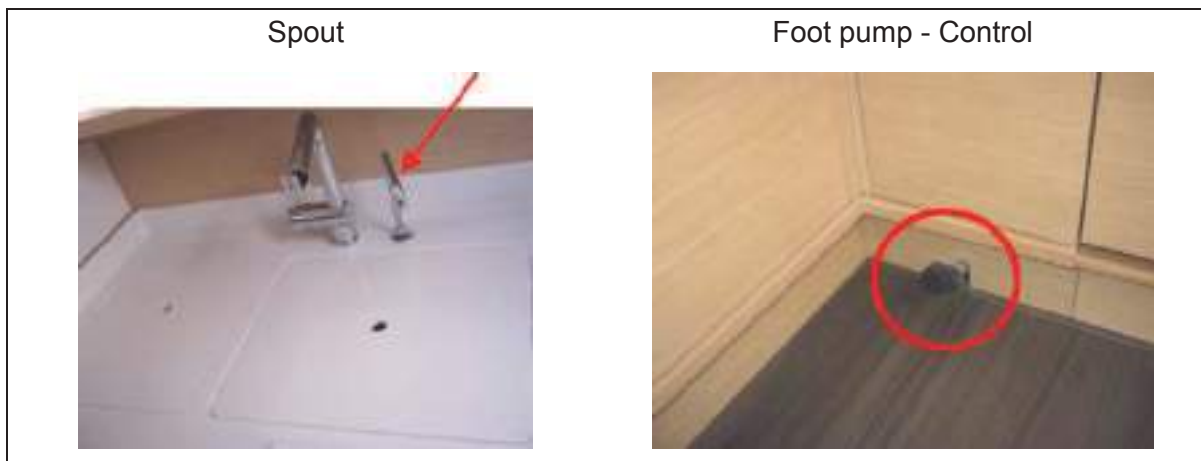

13.5.6 Water heater

- The water heater allows the use of hot water on board the boat.
- The water heater operates by heat recovery from the engine cooling circuit or the on board AC electrical supply.
- The water heater thermostat regulates the water temperature only when it is operating with electrical resistance. The thermostat is pre-set in the factory.
- The mixer tap allows the temperature leaving the water heater to be adjusted.
- Never switch on the water heater if it is not filled with water.

Location: Floor - Saloon



1. Water heater - 80 l
2. Mixer tap

Supply valve - Water heater / Cooling system - Engine



This valve blocks off the hot water system between the engine and the water heater

13.5.7 Water maker

Water any dessalinisateur am arriving directly at the reservoir of water. There is no gate of slection.

Location: Saloon seating



Sea water intake
Access: Passageway - Galley



- Refer to manufacturer's instructions for use and maintenance.

Control

Location: Electrical panel



13.6 BLACK WATER SYSTEM (WC)

General points

- Black water is human waste including the flushing water from the toilets.
- Close the valves after each use and above all when the boat is unattended.
- Regularly check the valves and thru-hull seacocks for proper operation and watertightness.
- Regularly check the tightness of the flexible pipe clamps and connections.

13.6.1 Location diagram of black water system



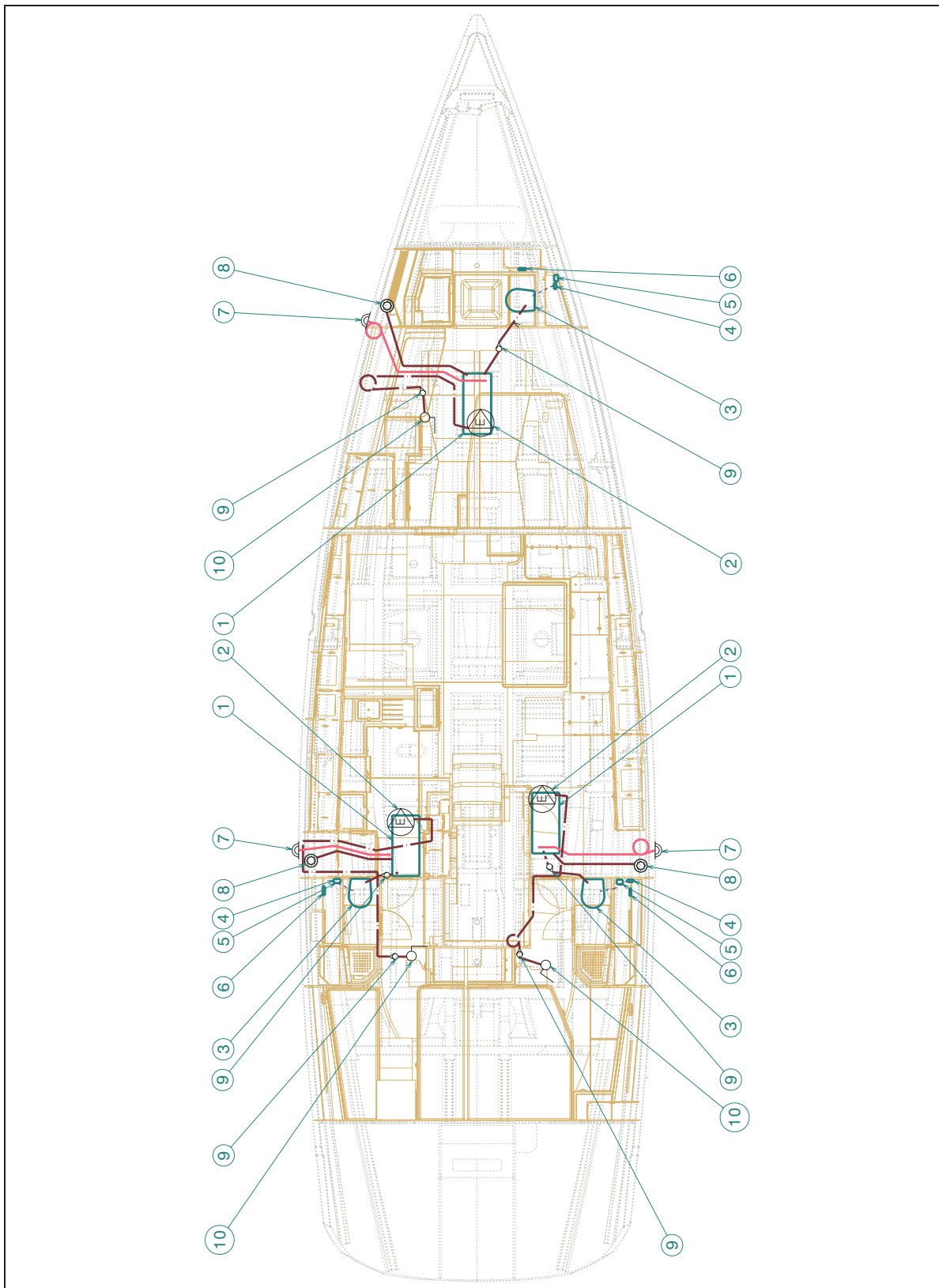

Version 3 cabins / Owner cabin - forward

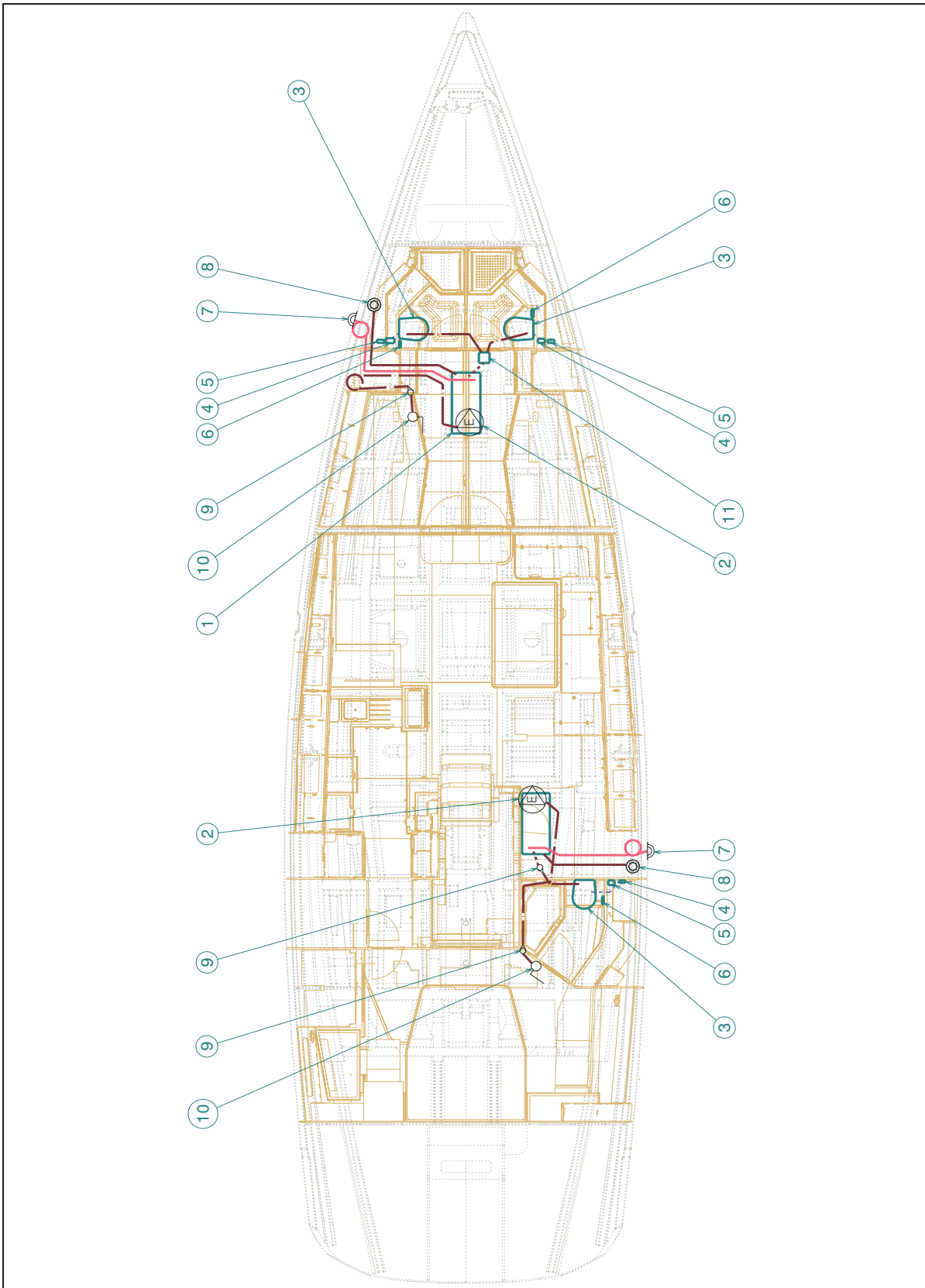

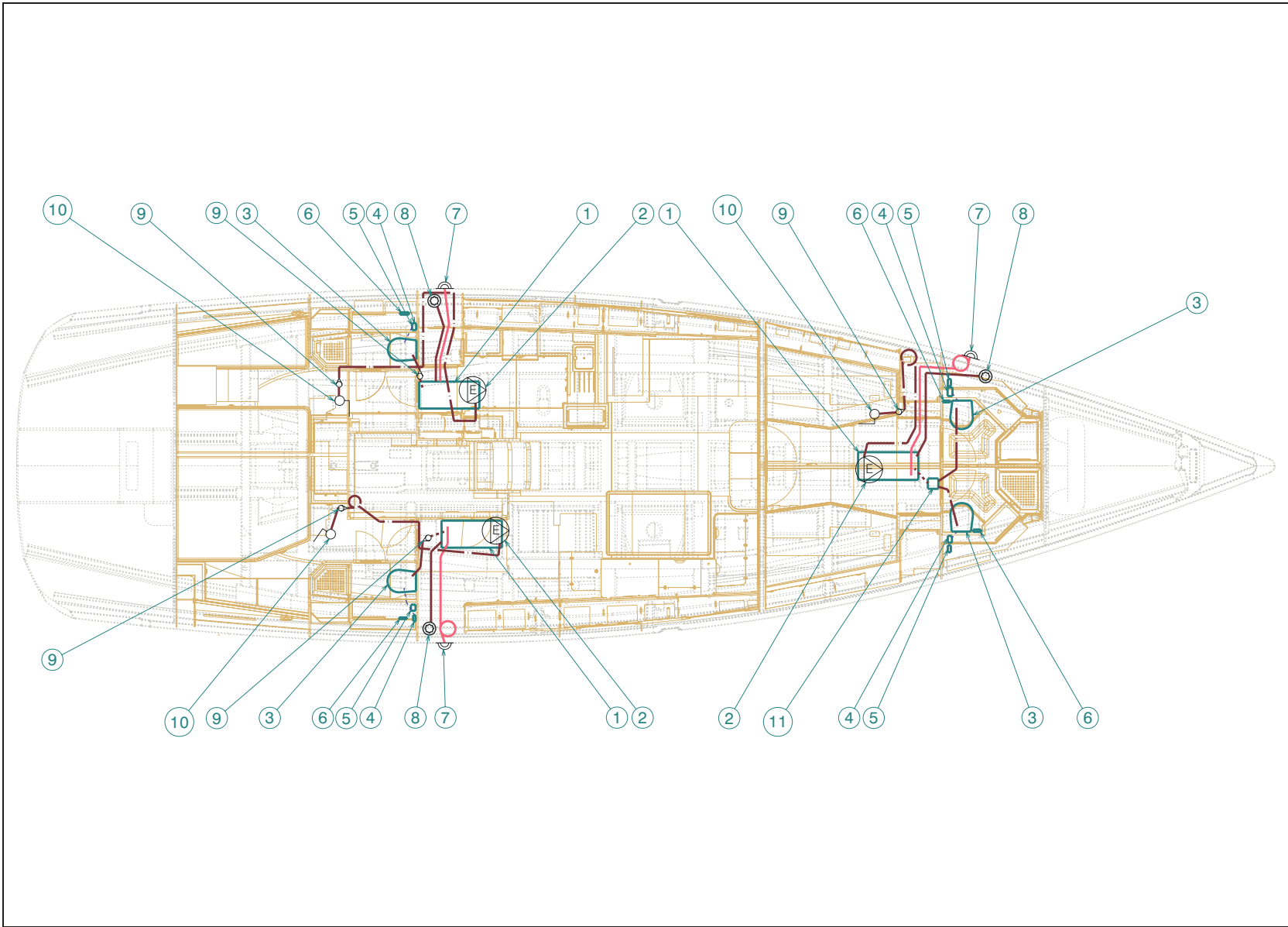
Version 3 cabins / Owner cabin - aft





	Supply pipe - Fresh water - 20 mm diameter
	Pipe - Vent hole - 25 mm diameter
	Draining hose - 38 mm diameter
	Pipe - Intake - 38 mm diameter
	Pipe - Sewage - 25 mm diameter

Reference	Designation
1	Black water tank
2	Masher (Pump - WC evacuation to sea)
3	Electric toilet
4	Electromagnetic valve
5	Electronics box
6	Switch - WC
7	Black water tank
8	'WASTE' pump out drain plug
9	Non-return valve
10	Thru-hull fitting - WC evacuation to sea
11	Connector



1. Sewage drainage - to sea

2. Sea water intake - WC

Electromagnetic valve
Location: WC - Port forward



Black water tank gauge
Location: Touch screen





YOUR BOAT IS FITTED WITH A BLACK WATER TANK

To minimise the smells coming from this tank, we advise the following use and maintenance:

1) Holding tank

- A black water tank is used solely for the temporary collection of water coming from the toilets.
- The tank can be emptied in 2 ways:
 - By connection to a pumping system that empties the tank by suction. This system uses the 'WASTE' deck connection.
 - Via the thru-hull fitting emptying directly into the sea (on condition that this is allowed by law in the country where the boat is sailing).
- Only use water soluble toilet paper to avoid any blockage.

Note: Sanitary towels and other items (paper handkerchiefs, dressings etc) in the toilets and black water tank will inevitably lead to blockages.

- Faecal matter causes formation of unpleasant odours in the black water tanks, to which the use of salt water for flushing the toilets also contributes. Algae present in salt water also give off unpleasant odours.
- Completely empty the black water system before leaving the vessel unattended in temperatures below freezing.
- Ask for information about the laws in force in your country or your marina about discharging your waste waters into the sea.

2) Use of toilets

- Every time the toilets are used, flush afterwards with copious amounts of water in the bowl using the toilet pump (manual or electric).
- When you are leaving the boat for several days, flush with fresh water, using for example the head's shower. Sea water that stagnates in the bowl gives off bad smells.

Black water tank
Capacity: 88 litre

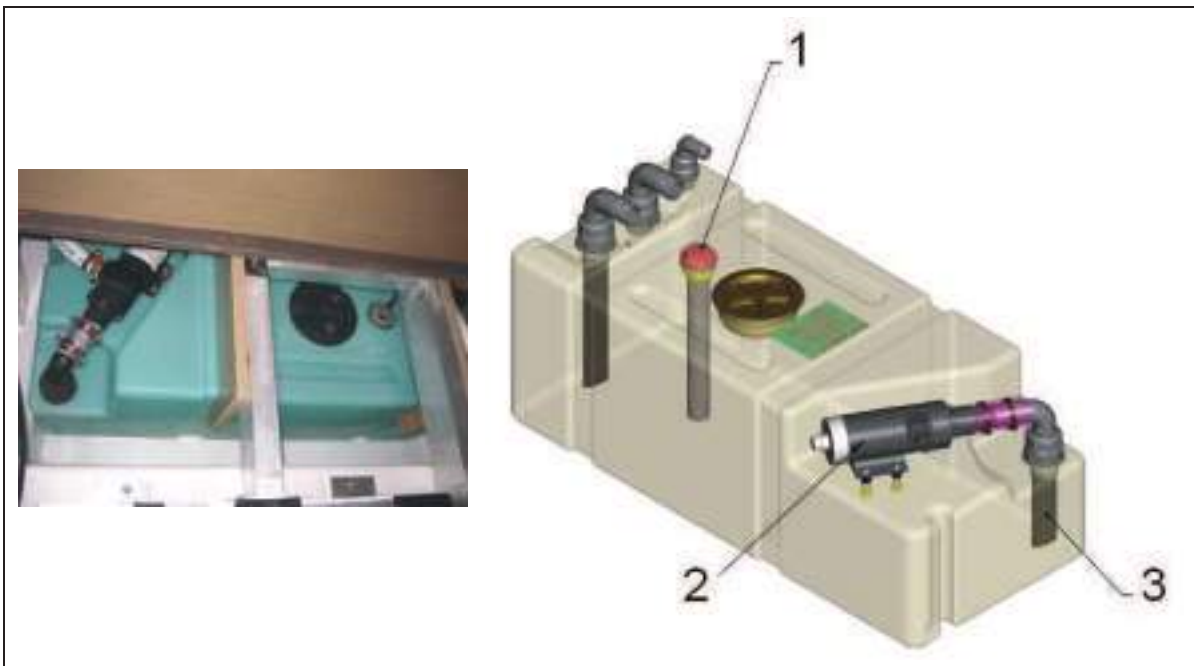

Reference	Designation
1	Gauge transmitter
2	Masher (Pump - WC evacuation to sea)
3	Plunger



3) Maintenance of black water tank

- The risk of unpleasant odours forming increases when the waste water remains in the tank for a long time.
- Whenever possible empty the tank regularly even before it is full.
- Every time the tank is emptied put in about 5 litres of fresh water and add an appropriate detergent additive (available from chandleries). A very simple method is soda salts, which clean and disinfect at the same time.
- Before winterising, flush the tank with copious amounts of fresh water filling it through the 'WASTE' deck connection. Leave at least 5 litres of fresh water mixed with a detergent additive.
- Disinfecting: Disinfect the tank once a year by filling it with a solution of Javel water (1 to 1000).



- Never use automobile anti-freeze in the black water system: risk of poisoning.

ADVICE-RECOMMENDATION

- Respect local regulations regarding the emptying of black water tanks.

**Layout diagram of black water system
Drainage by electric pump DC (Masher)**

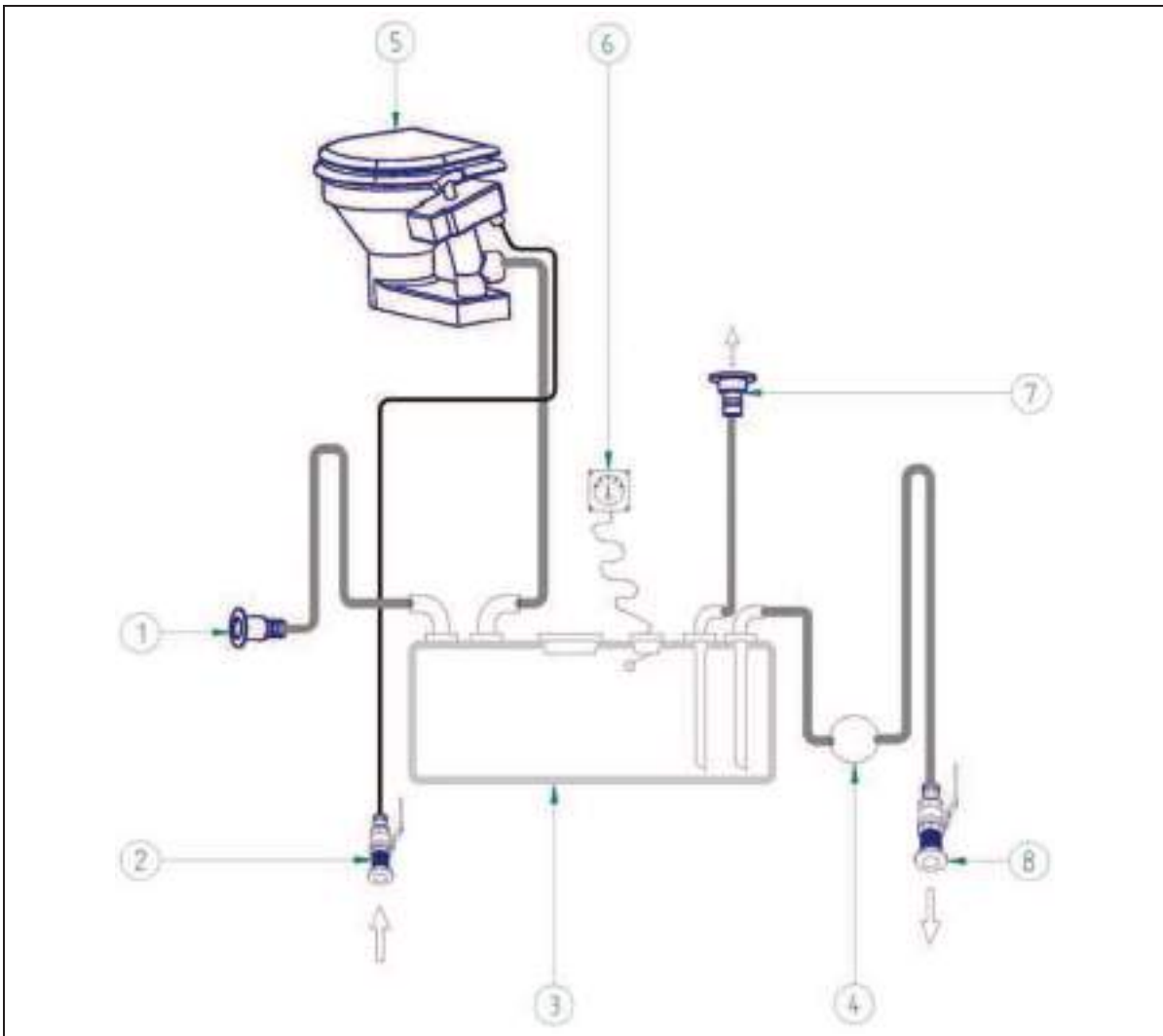

Reference	Designation
1	Vent hole
2	Seawater intake valve
3	Black water tank
4	Masher (WC drainage pump)
5	WC
6	Gauge
7	'WASTE' deck connection
8	Sea discharge valve

Using a marine toilet with a tank drain by macerator

- I. Open the sea water intake valve (Ref 2).
- II. Fill the bowl by using the manual toilet pump.
- III. Using the toilet (Ref 5).
- IV.a. To empty the organic waste in the tank:
 - Make sure the thru-hull seacock (Ref 8) is closed.
 - Empty the bowl using the manual toilet pump.
- IV.b. In the case of a direct discharge into the sea:
 - Open the thru-hull seacock (Ref 8).
 - Empty the bowl using the manual toilet pump.
 - Empty the tank by switching the electric pump (Ref 4).
- IV.c. To discharge through the deck:
 - Open the deck connection marked 'WASTE' (Ref 7).
 - Use the pump-out system where fitted at a port.

Use of a DC electric toilet has a tank-discharge macerator

- I. Open the sea water intake valve (Ref 2).
- II. Fill the bowl by pressing the fill button.
- III. Using the toilet (Ref 5).
- V.a. To empty the organic waste in the tank:
 - Make sure the thru-hull seacock (Ref 8) is closed.
 - Empty the bowl by pressing the empty button.
- IV.b. In the case of a direct discharge into the sea:
 - Open the thru-hull seacock (Ref 8).
 - Empty the bowl by pressing the empty button.
 - Empty the tank by switching the electric pump (Ref 4).
- IV.c. To discharge through the deck:
 - Open the deck connection marked 'WASTE' (Ref 7).
 - Use the pump-out system where fitted at a port.



Refer to manufacturer's instructions for use and maintenance.

13.7 WASTE WATER SYSTEM

General points

- The waste water system is the water coming from the sink, showers, air conditioning drains and washbasins.
- Close the valves after each use and above all when the boat is unattended.
- Regularly check the valves and thru-hull seacocks for proper operation and watertightness.
- Regularly check the tightness of the flexible pipe clamps and connections.

ADVICE-RECOMMENDATION



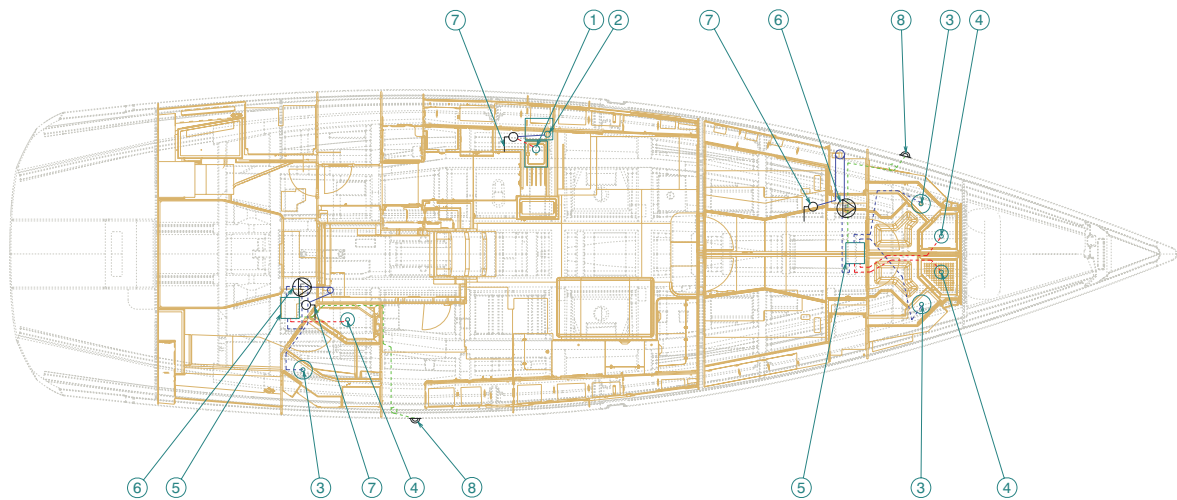

- Observe local regulations regarding the emptying of grey water tanks.

Diagram of the layout - Waste water system

Version 3 cabins - Owner cabin - aft







WATER SYSTEMS

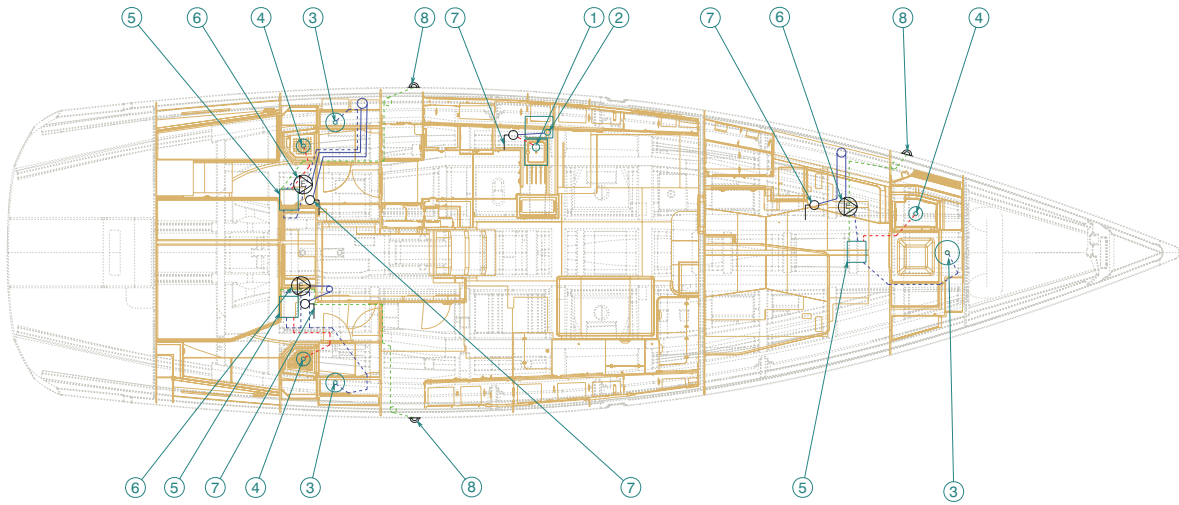



	Pipe - Vent hole - 20 mm diameter
	Pipe - Waste water - 20 mm diameter
	Pipe - Waste water - 25 mm diameter
	Pipe - Waste water - 40 mm diameter

Version 3 cabins - Owner cabin - forward

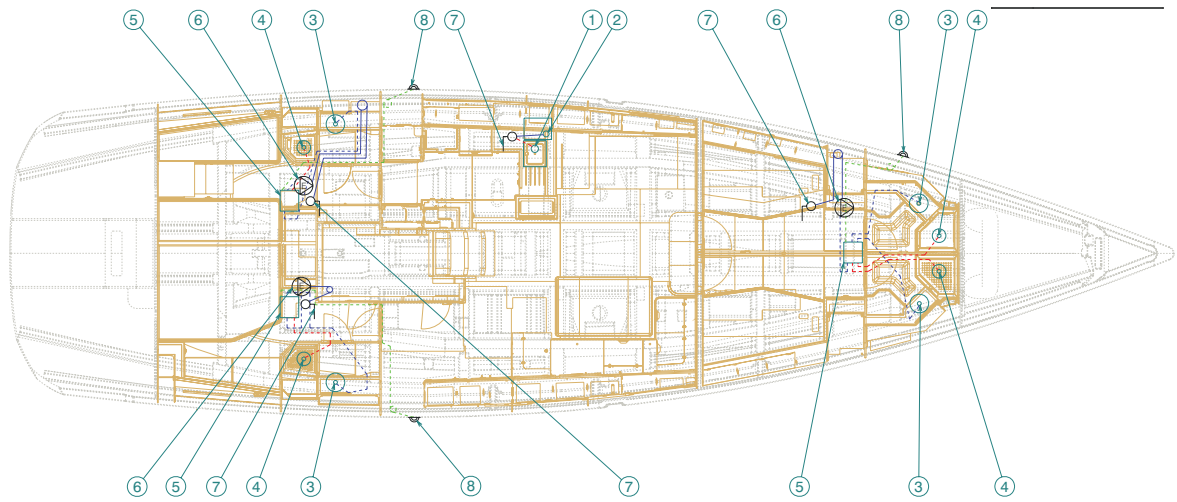





	Pipe - Vent hole - 20 mm diameter
	Pipe - Waste water - 20 mm diameter
	Pipe - Waste water - 25 mm diameter
	Pipe - Waste water - 40 mm diameter

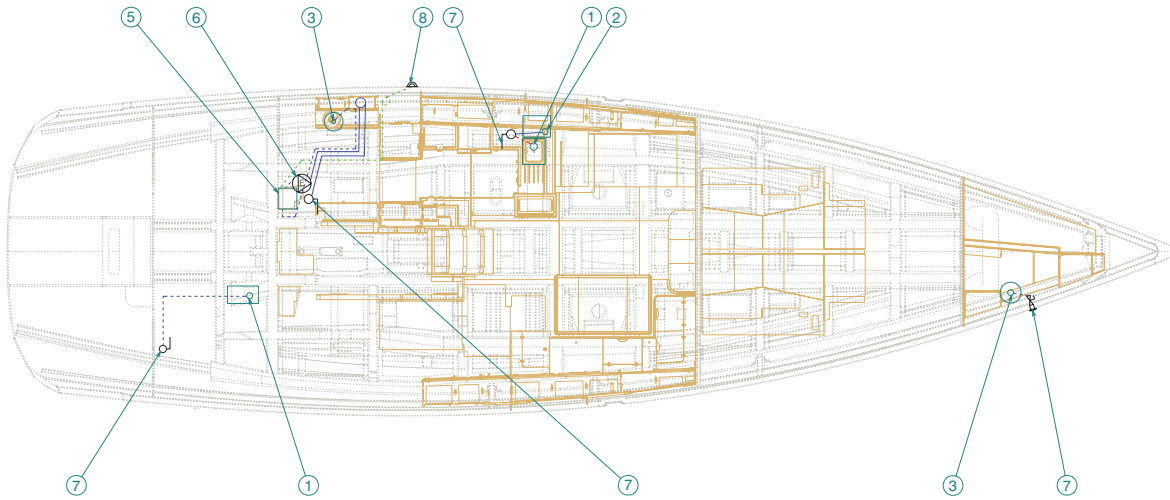

	Pipe - Vent hole - 20 mm diameter
	Pipe - Waste water - 20 mm diameter
	Pipe - Waste water - 25 mm diameter
	Pipe - Waste water - 40 mm diameter

Options



	Pipe - Vent hole - 20 mm diameter
	Pipe - Waste water - 20 mm diameter
	Pipe - Waste water - 25 mm diameter
	Pipe - Waste water - 40 mm diameter

Reference	Designation
1	Galley sink
2	Draining rack
3	Washbasin - Head version
4	Shower
5	Collector - Waste water
6	Pump - Drainage of the waste waters - to sea
7	Waste water drain thru-hull - to sea
8	Vent hole - Collector

Shower plug hole



Collector - Waste water



Shower pump



Shower screen



NOTE: MUST BE SECURED WHILE SAILING.

14 ENGINE

14.1 INFORMATION ABOUT THE RISKS OF FIRE AND OF EXPLOSION OF ENGINES

- Make sure that the coolant is circulating properly.
- Ensure that the engine compartment ventilation air inlets are kept clear.
- Stop the engine and refrain from smoking during fuel tank filling.
- Get your fuel circuit checked regularly by a professional engineer.
- Avoid any contact between inflammable materials and the hot sections of the engine.
- Never switch off or de-energise the electric system when the engine is running.
- Never block the access of the fuel supply valve.
- Do not obstruct or modify the ventilation system.
- Never turn the engine over when the boat is on land.
- Fuel stored outside the fuel tanks (jerrycans, spare cans) must be kept in a well-ventilated place.
- Regularly check that the engine compartment is clean and dry.



14.2 DANGER FROM MOVING MECHANICAL PARTS

- Keep away from the moving parts of the engine (belts and moving parts or hot components) and the drive shafts etc..
- Be careful if you have long hair, bulky clothing, rings etc (at risk of being caught).

14.3 GENERAL POINTS

- Don't install an engine more powerful or heavier than recommended on this boat, this risks compromising the boat's stability.
- Make sure you have enough fuel before sailing.
- Stop the engine before opening the engine compartment.
- Don't close the fuel supply valve between each use of the engine (unless for a lengthy absence).
- Get the whole propulsion system checked at least once a year by a professional engineer. see the chapter on "Manoeuvrability".

Always start the engine with the control lever in neutral.

ADVICE-RECOMMENDATION

- Regularly check that the O ring on the filler cap is in good condition, to prevent any water ingress.
- Keep the fuel tank as full as possible to prevent condensation.
- Be careful with any possible risk of oil and fuel spillage.
- Follow the engine manufacturer's instructions exactly.
- **Never switch off the battery breakers when the boat's engine is running (risk of serious damage to the charging circuit).**

14.4 STARTING THE ENGINE

Before starting the engine, it is imperative:

- to open the fuel supply valve ;
- to open the sea water intake valve of the engine ;
- to open the sea water intake seacock for the stern gland ;
- to switch on the battery supply by using the battery isolator switches ;
- to put the control lever in neutral.

Make a habit of looking to see if sea water is pumped out with the exhaust gases as soon as you start the engine. If no water runs out, stop the engine immediately. Check the coolant flow.

As soon as the engine starts, the engine compartment bilge fan operates.



- Before using the engine, make sure you carefully read the handbook provided by the engine manufacturer.



- Always start the engine with the control lever in neutral.
- Learn how to judge the necessary distance of deceleration for the vessel to come to a complete stop (The reverse gear is not a brake).

Electronic key
Starting - Engine



Type of motorisation

Your vessel is fitted with an in-board diesel engine.

The transmission is of a shaftline type.

Filling up with fuel

- Fill the fuel tank by opening the cap marked "DIESEL", provided for this.
- Fuel capacity: 500 l (Main tank) + 325 l (Reserve tank).
- Regularly check that the O ring on the filler cap is in good condition, to prevent any water ingress.
- The generator has its own fuel supply valve.

Each tank has its own filling plug.

There is no interconnection valve between the tanks. If the engine stops when the propeller is not folded properly in reverse, the drive shaft brake cannot stop the propeller (see section "diesel transfer pump").

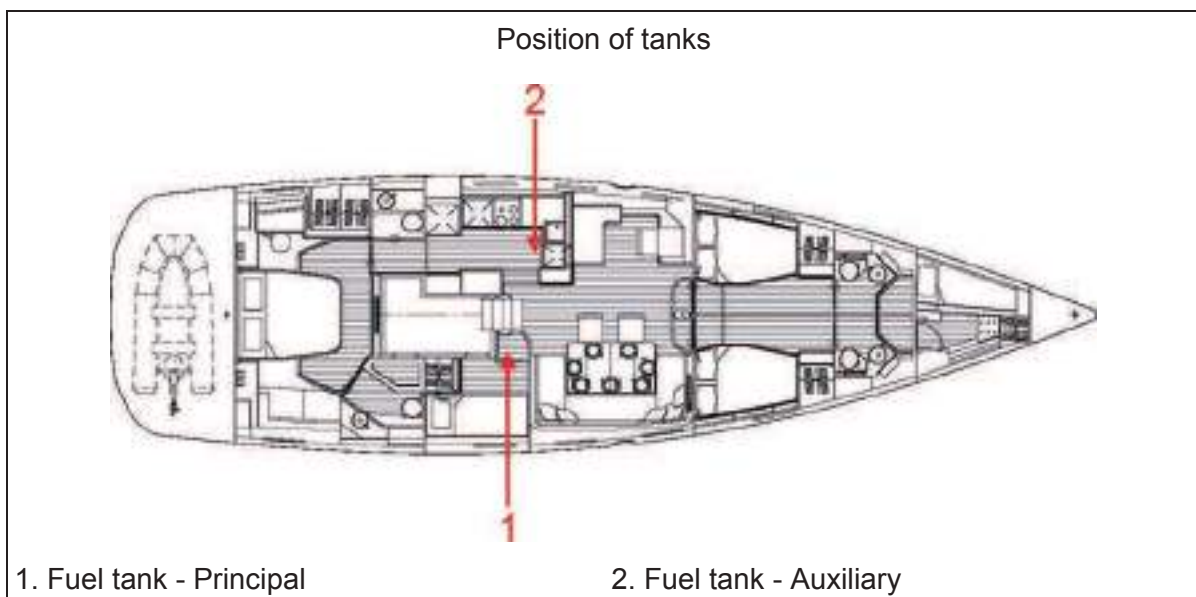

Gauge

- The fuel level is transmitted from the dipstick to the indicator located on the electrical panel.
- Some of the gauges must be calibrated when you first fill the tanks: please consult your dealer.

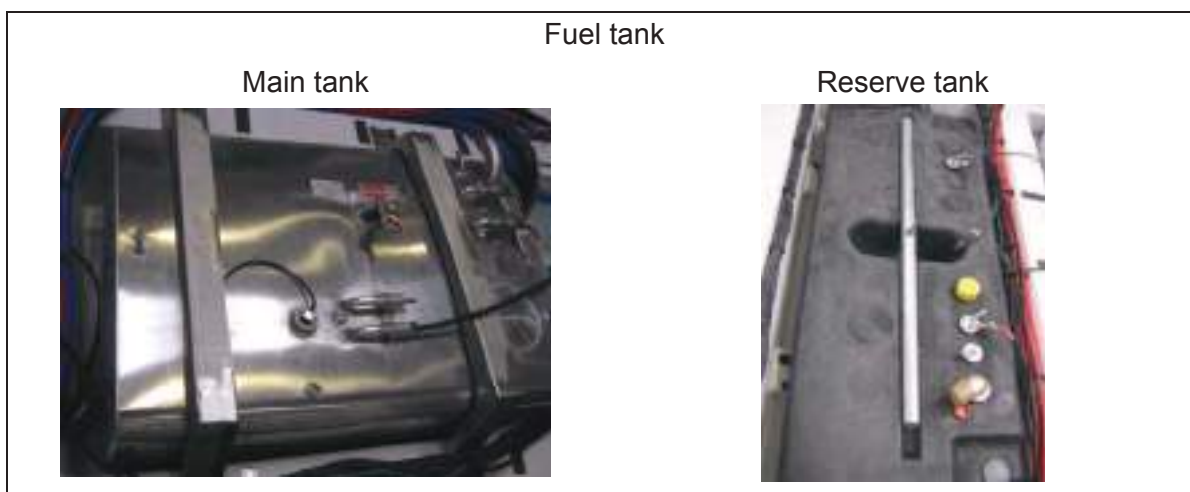
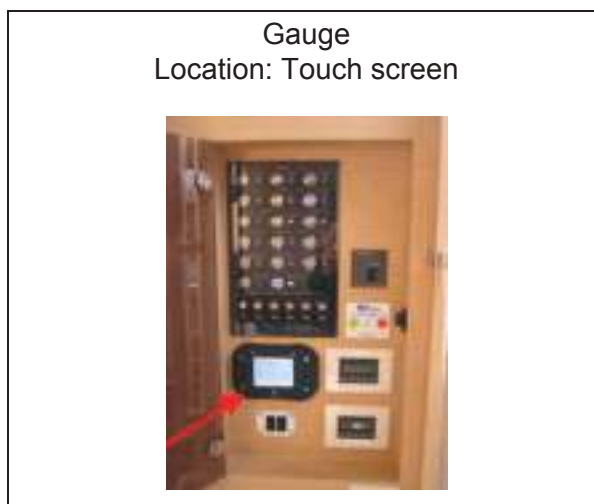

- The tanks' nominal capacity cannot be fully used due to the load and the need to maintain the correct trim. A 20% reserve should be kept.

14.5 ENGINE WATER INTAKE VALVE

The sea water intake valve plays a crucial role in ensuring that the engine runs well.

- Keep the strainer under the hull as clean as possible ;
- Brush the strainer whenever the boat is lifted out ;
- Don't cover the strainer in antifoul.

This valve must absolutely always be opened before starting the engine.

A sea water filter filters the water before it goes through the heat exchanger.

Regularly inspect the sea water filter and clean it if necessary. Screw/unscrew the cover of the filter by hand (never use tools for this).

For lengthy absences, close the engine's sea water intake valve.

Access: Engine compartment

Sea water intake



Sea water filter



14.6 ANTI-SIPHON VALVE

- The function of the anti-siphon valve is to inhibit the siphoning action when the engine stops thus preventing a return of water.
- It is possible that on starting the engine or at certain engine speeds some drops of water may be seen escaping from the anti-siphon valve.
If so you need to clean the anti-siphon valve: dismantle the water collector at the top of the anti-siphon valve, then clean the valve with fresh water to remove any impurities.
- Then do the reverse procedure to refit the cleaned component, taking care not to refit the valve the wrong way round.
- This simple preventative maintenance procedure of the anti-siphon valve is recommended to be carried out once a year.



14.7 FUEL FILTER

Engine running problems may have different origins, including dirty fuel. The injection pump may wear out if there is water in the system. The water results either from the condensation resulting from an insufficiently filled tank, or from a filler cap either not closed properly or with a damaged seal.

In order to prevent any water infiltration, the fuel runs through two filters:

- One filter is an integral part of the engine, its role is to filter fuel very finely. Please refer to the engine manufacturer's notes for any maintenance and for the frequency of filter changes.
- The second filter is on the pipe that links the tank to the engine, it plays the role of a water decanter and prefilter.

Maintenance

- Purge the impurities by unscrewing the screw located at the base of the decanting bowl (without removing it). Let the liquid run into a receptacle until the fuel runs clear. Do this several times a year.
- Change the pre-filter at least once a year.

Access: Engine compartment



14.8 ENGINE INSTALLATION



INSTALLATION OF SHAFT ENGINE WITH BRACKET

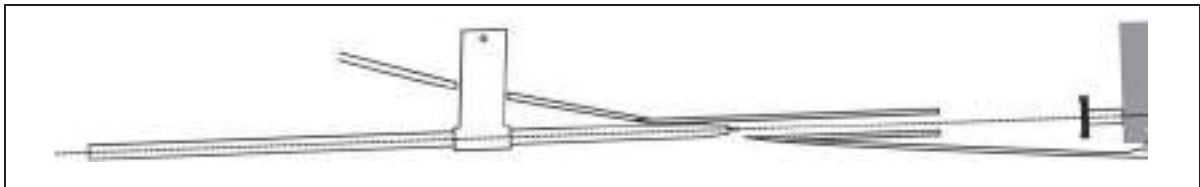
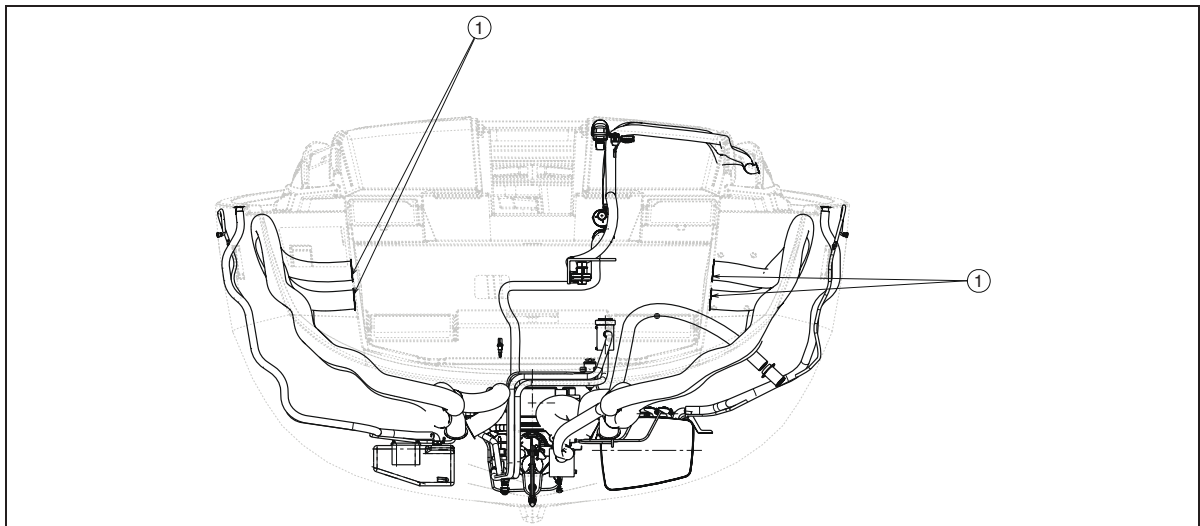
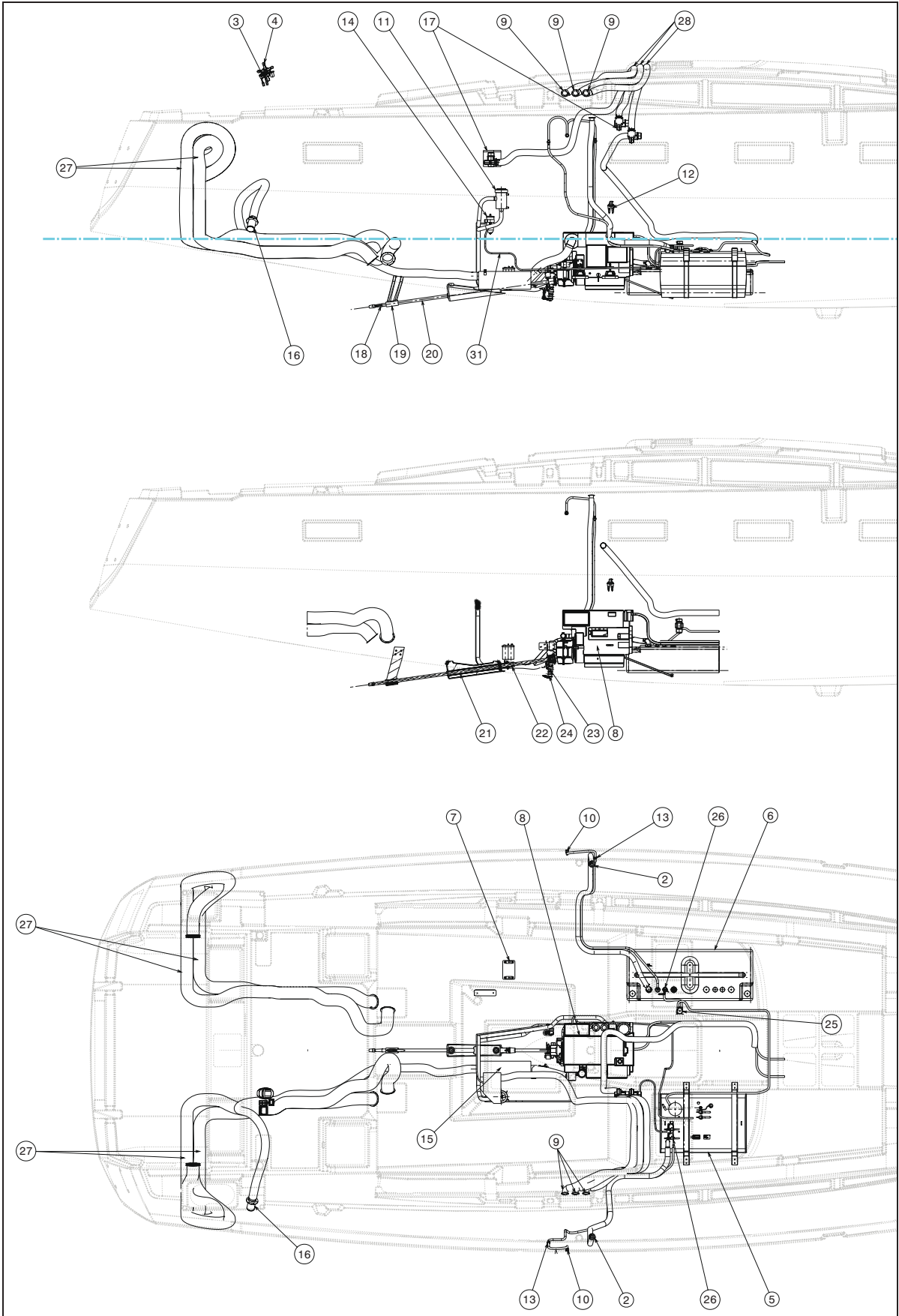

Diagram of the in-board engine layout







Reference	Designation
1	Sleeve
2	Oil filler cap
3	Instrument panel - Engine
4	Engine control lever
5	Main tank (aluminium)
6	Reserve tank (rotation moulded)
7	Engine battery
8	Engine & Reverser (2.43 / 1 ratio)
9	Windsock
10	Vent hole - Fuel tank
11	Sea water filter
12	Anti-siphon valve
13	Anti-flooding valve
14	Fuel filter
15	Water trap
16	Engine exhaust
17	Ventilator - Engine compartment
18	Propeller
19	Bearing
20	Propeller shaft + Coupling flange
21	Stern frame
22	Stuffing box
23	Seawater intake valve
24	Thru-hull fitting
25	Diesel transfer pump
26	Remote shut-off pull handle - Fuel
27	Fresh air inlet
28	Hot air extraction

14.9 ENGINE CONTROL

- The engine manufacturer's notes provide detailed explanations on how to operate the engine and keep it running well.
- Read the manufacturer's notes on use and maintenance of the engine.



Stopping the engine

Before switching off the engine, put it into reverse for a few seconds to allow the propeller to fold correctly. This operation will allow the drive shaft brake to stop the propeller when it is folded in this way.

NOTE: if the engine stops when the propeller is not correctly folded while moving in reverse, the drive shaft brake cannot stop the propeller. when the boat is under sail, a propeller that is not folded properly will drag on the drive shaft. this can cause serious and irreversible damage to the whole transmission system.

14.10 ACCESS TO THE ENGINE

The access to the engine is via:

- Side hatches,
- the companionway.

All access hatches to the engine absolutely must be kept shut when at sea.

14.11 DIESEL TRANSFER PUMP

- The transfer pump allows fuel to pass from one tank to the other.
- The boat's engine is supplied with fuel from the main tank. When it is empty, a pump allows fuel to be transferred from the reserve tank to the main tank.

The switch located on the pump must be permanently in the ON position: The pump control is shifted onto the touch screen.

NOTE: there is no system for transferring fuel from the reserve tank to the main tank manually.

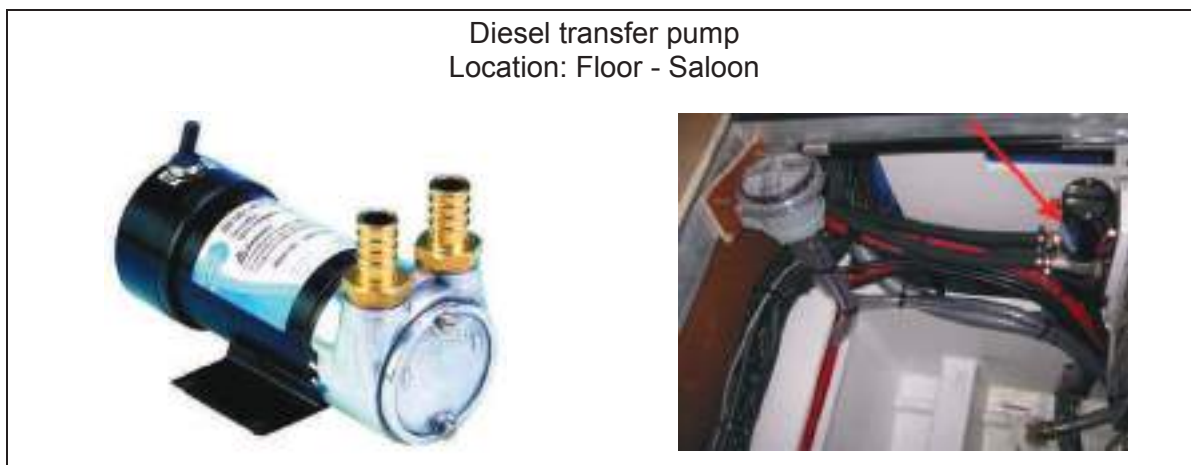
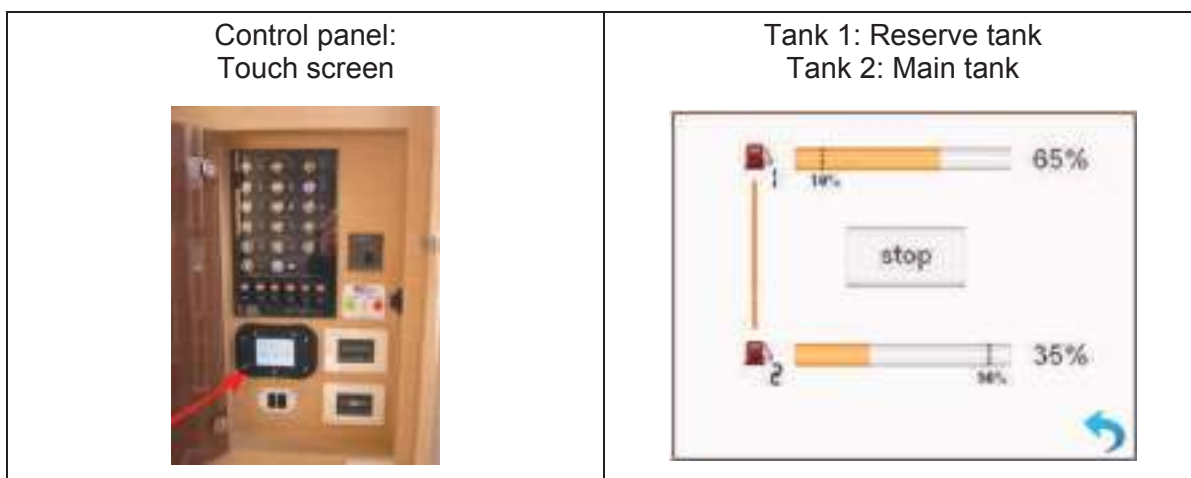

14.12 PROPELLER SHAFT

- The shaft is stainless steel.
- The shaft is aligned in the factory. When the boat is launched, its re-adjustment must be carried out by a professional.
- A hydrolube bush holds the shaft in the bracket.

This is a wearing ring. Check the hydrolube bush every time the boat is slipped. Change the hydrolube bush if necessary.

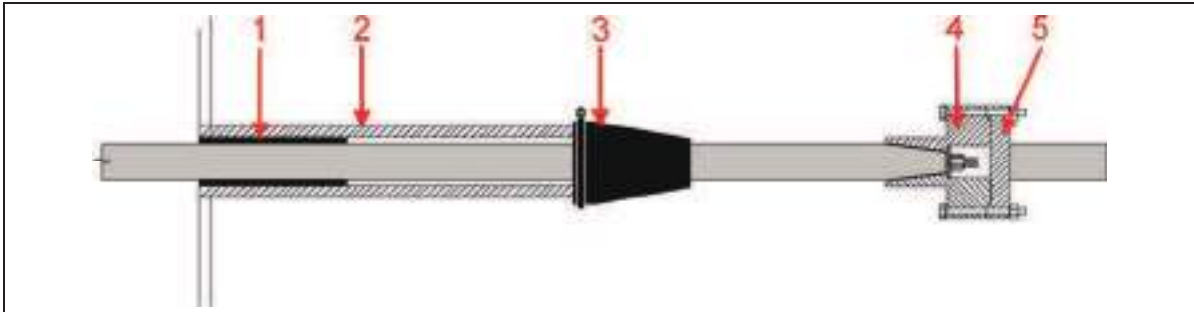

Reference	Designation
1	Hydrolube bush
2	Stern frame
3	Stuffing box
4	Connecting plate
5	Flange