

## FORE CABIN CONVERSION

6



7- Unlock the bolt on the upper berth.



8- Unlock the bolt at the foot of the bulkhead.



9- Dislodge the lateral bulkhead. This bulkhead is hinge mounted and can be folded up. Put it aside.



10- Fold the upper berth.  
11- Open the starboard fore locker.  
12- Remove the lower mattress.  
13- Prepare the supporting straps.  
14- Put first the bulkhead nbr 5.  
15- Put back the lower mattress in place.  
16- Put the bulkhead nbr 6 and then 9.  
17- Stap up the bulkheads.



18- Unlock the upper berth support strap snap hook.  
19- Turn the berth into seat back.



20- Put the door 1 in the hanging locker: Wedge it between the pieces of wood and fasten it with the shockcord.

indice 0



21- Take the door 4 off its hinges to position the door frame.  
22- Brooch the door frame and screw the covers (see 2).  
23- Hinge the door.

accommodations

36  
58



# PLUMBING



WATER TANK FILLING

FRESH WATER SYSTEM

GAS SYSTEM

WATER DISCHARGE

SANITARY APPLIANCES OPERATION

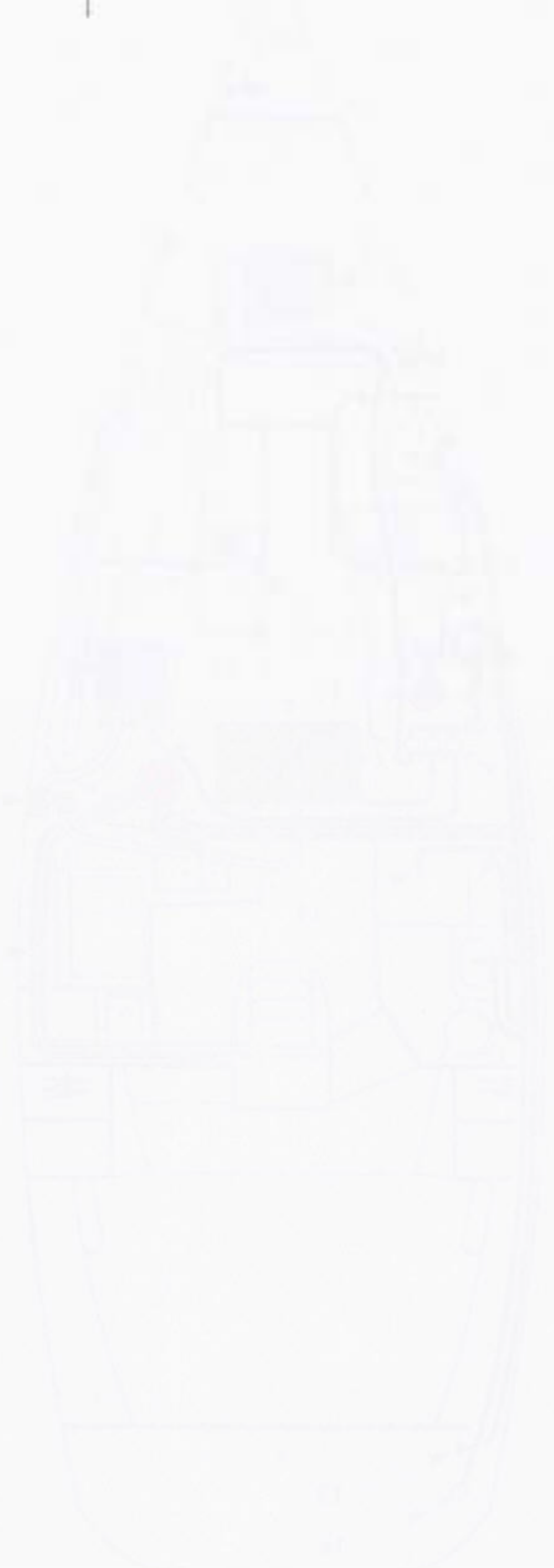

**FRESH WATER**

- 1- Tank breather
- 2- Water tank
- 3- Deck filler
- 4- Mixer tap
- 5- Hot water hoses
- 6- Cold water hoses
- 7- Water pressure unit
- 8- Water meter
- 9- Fresh water filter
- 10- Water tank select valves
- 11- Accumulator tank
- 12- Water heater
- 13- Engine cooling fluid hoses
- 14- Shower
- 15- Hot water inlet available
- 16- Deck transom shower
- 17- Bilge pump (Refer to Drainage)
- 18- Bilge pump filter (Refer to Drainage)

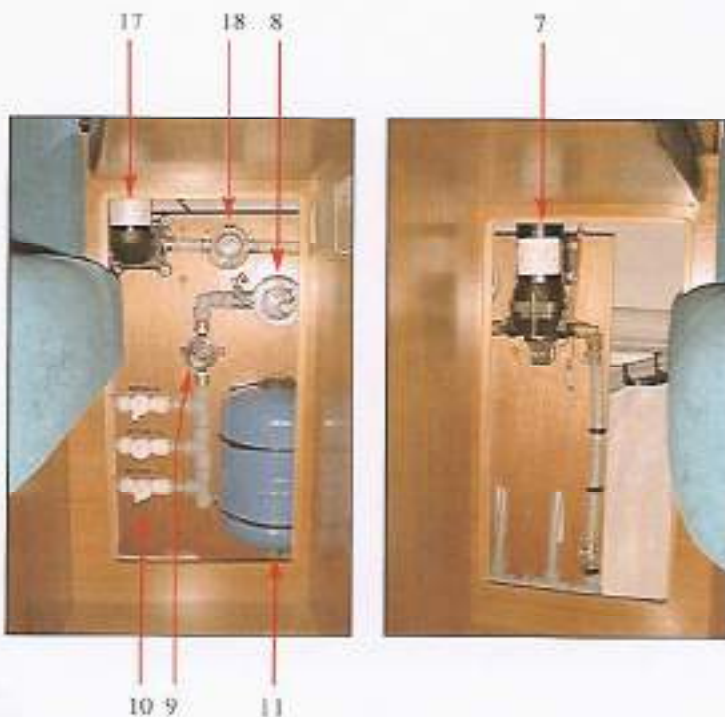
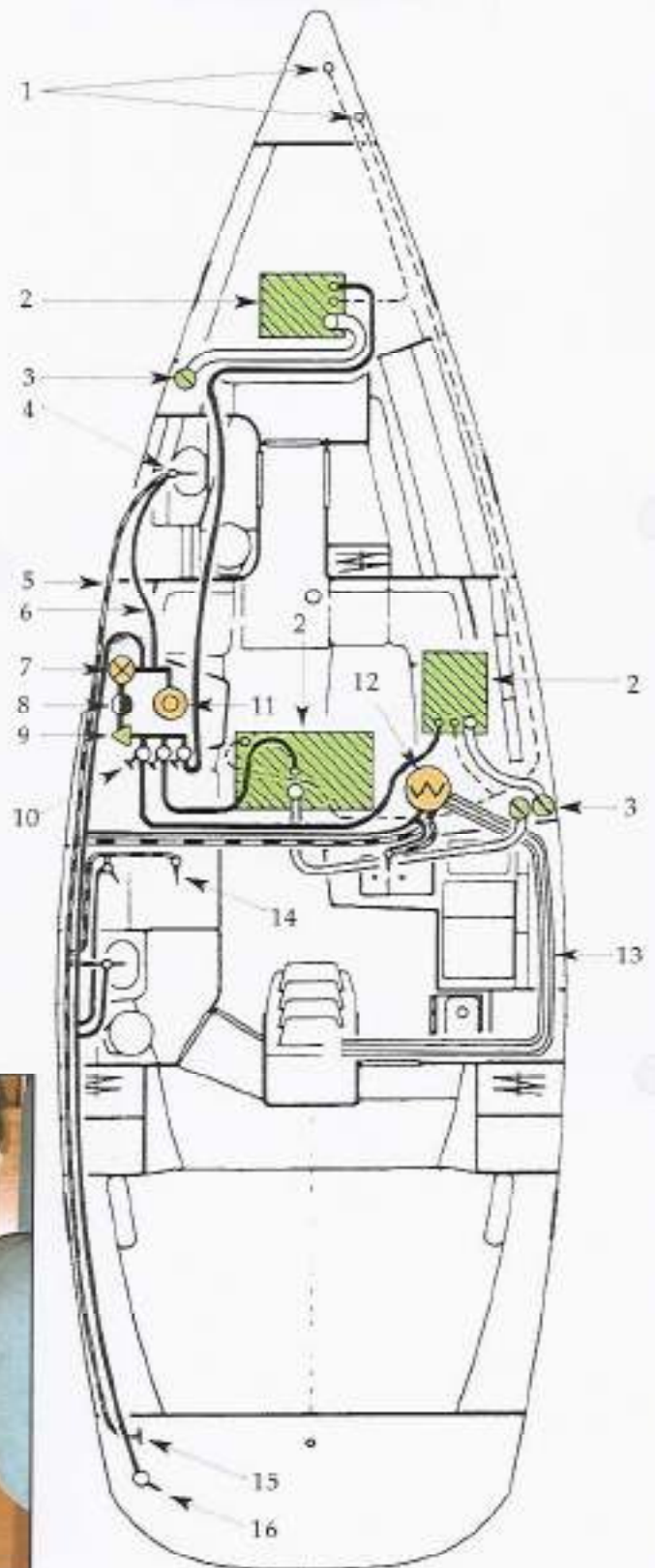

Same places for other accomodation versions



## WATER TANK FILLING

In order to obviate any handling mistake, never fill the water and fuel tanks at the same times.

During filling, avoid handling contaminants near the filling plugs.

Open and close the filling plugs with the special spanner.

Check the filler plug seals for condition during filling.

The tanks are fitted with overflow outlets and vents.

To prevent a pressure build-up in the system, never press the water filling hose deep into the system.

### RECOMMENDATIONS / MAINTENANCE

The tanks can be sterilized by adding a "clonazone" tablet (available from chemists).

Purify the tanks and pipes with acetic acid or white vinegar if the boat is to stay unmanned for a long period.

Inspection ports are provided on tanks through which internal cleaning can be performed.

Refer to chapter 11 for winter precautions.

## GALLEY SINK DRAINAGE



- 1 - Sink drainage
- 2 - Seacock with valve

## SEACOCK



**Closed seacock**



**Open seacock**



## FRESH WATER SYSTEM

### PRECAUTION

Never run the water system if the valve is closed or the tank is empty to avoid damaging the electrical equipment. Check the water filter for condition as instructed in the manufacturer's manual.

## GAS SYSTEM





(Refer to Chapter 2 « Safety »)

Refit the cap in place on the pressure reduction valve screwed section to avoid corrosion, when changing the cylinder.  
Change the hose on schedule.

### RECOMMENDATIONS

Don't forget to shut off the gas safety valve and pressure reducing valve when the heater is not in use.

## DRAINAGE & GAS SYSTEM

-  1- Seacock with valve
-  2- Electric pump
-  3- Filter
-  4- Sea water intake hose
-  5- Drainage hose

- 6- Sump electric pump
- 7- Manual bilge pump in cockpit
- 8- Water heater
- 9- Water heater drainage valve
- 10- Iceboxe drainage
- 11- Gas circuit valve
- 12- Gas hoses
- 13- Gas bottle

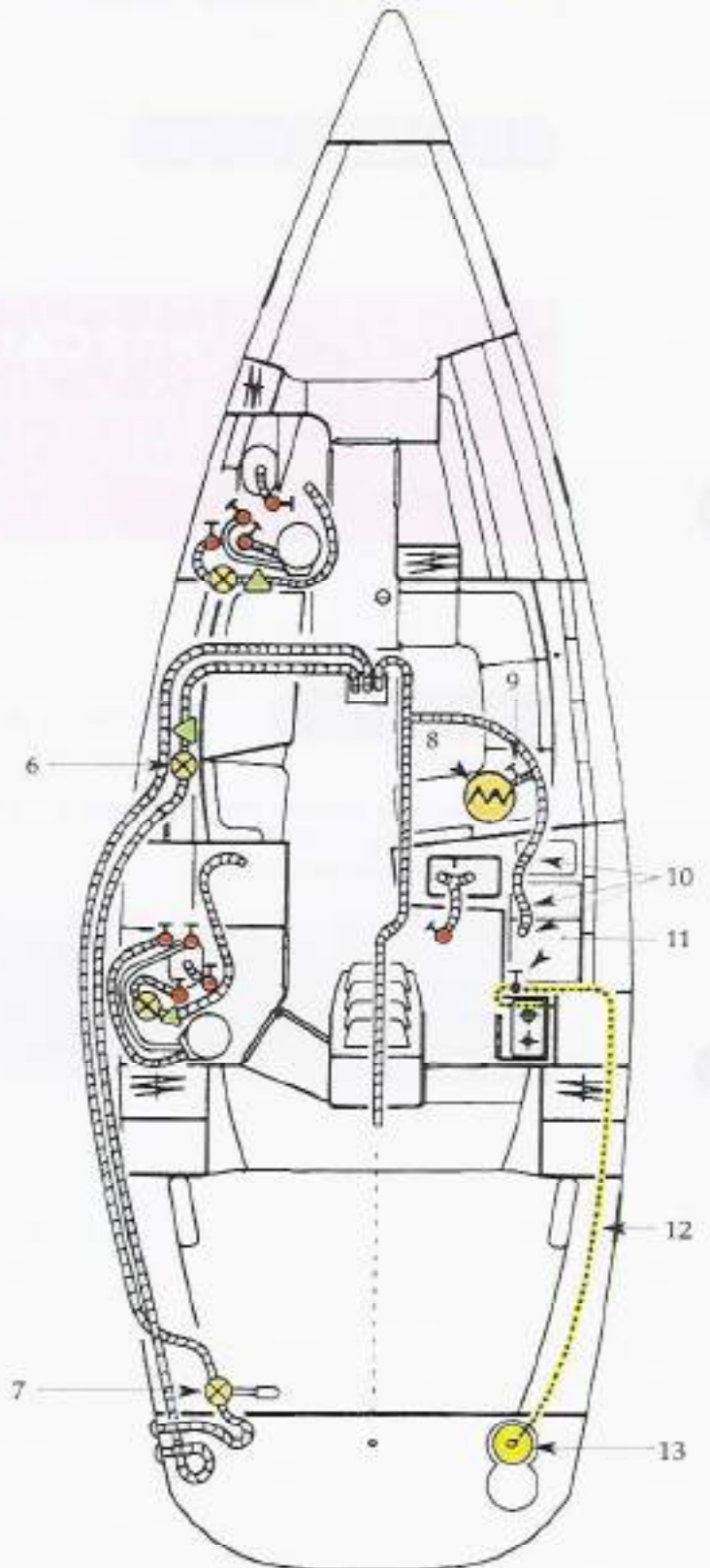

Same places for other accomodation versions





## WATER DISCHARGE

Waste water from the sink, wash basins and the closets is discharged by sea chests, fitted with quarter turn valves (when the valve handle is perpendicular with the pipe, the valve is closed, and open when along the pipe centreline).

All floors include water courses (limber holes). ( A waterproof carter under the engine receive the possible oil leaks).

A main sump located above the ballast collects the water from the floor and is drained by means of an electric pump or the manual pump in the cockpit.

### RECOMMENDATIONS / MAINTENANCE

Check the valves and sea cocks for water tightness and operation regularly.

Shut the valves when the system is not in use.

Check the clamps and hose pipe couplings and seals for condition.

Ensure regularly that the bilge and strum-boxes are perfectly clean.

If one pump should be running while all water supplies are shut, switch the power off immediately.

Check the water system and eliminate the breakdown.

## BATHROOM DRAINAGE PRINCIPLE



FORE BATHROOM



AFT BATHROOM

- 1- Shower tub drainage
- 2- Filter
- 3- Seacock with valve, shower outlet pipe
- 4- Seacock with valve, sink outlet pipe
- 5- Seacock with valve, sea water intake for closets



## SANITARY APPLIANCES OPERATION

### MARINE CLOSETS OPERATION :

Ensure that the water supply and discharge valves are open before using the appliance. To drain the bowl, set the pump lever to "FLUSH" and actuate the pump. To strip the bowl, set the pump lever back to "DRY" and actuate the pump.

Use exclusively absorbing paper to avoid clogging the closets and rinse the system regularly with fresh water. Shut the valves after every use and especially when the boat is unattended.

### WASH BASINS AND SHOWERS OPERATION :

The valves and cocks should be closed after use. To drain the shower tub, actuate the pump switch.

### RECOMMENDATIONS

During shore stay, use if possible the club-house sanitary appliances.  
Waste water rejection is restricted in some country or marina ;  
Waste tank is necessary.



# WIRING



**BATTERY MASTER SWITCHES**

**BATTERIES**

**OPERATION**

**220V CIRCUIT**

**SHORE POWER CABLE**

**MAST HARNESS CONNECTION**

**ELECTRONICS**

**DRAWINGS & DIAGRAMS (end of chapter)**

## BATTERY MASTER SWITCHES

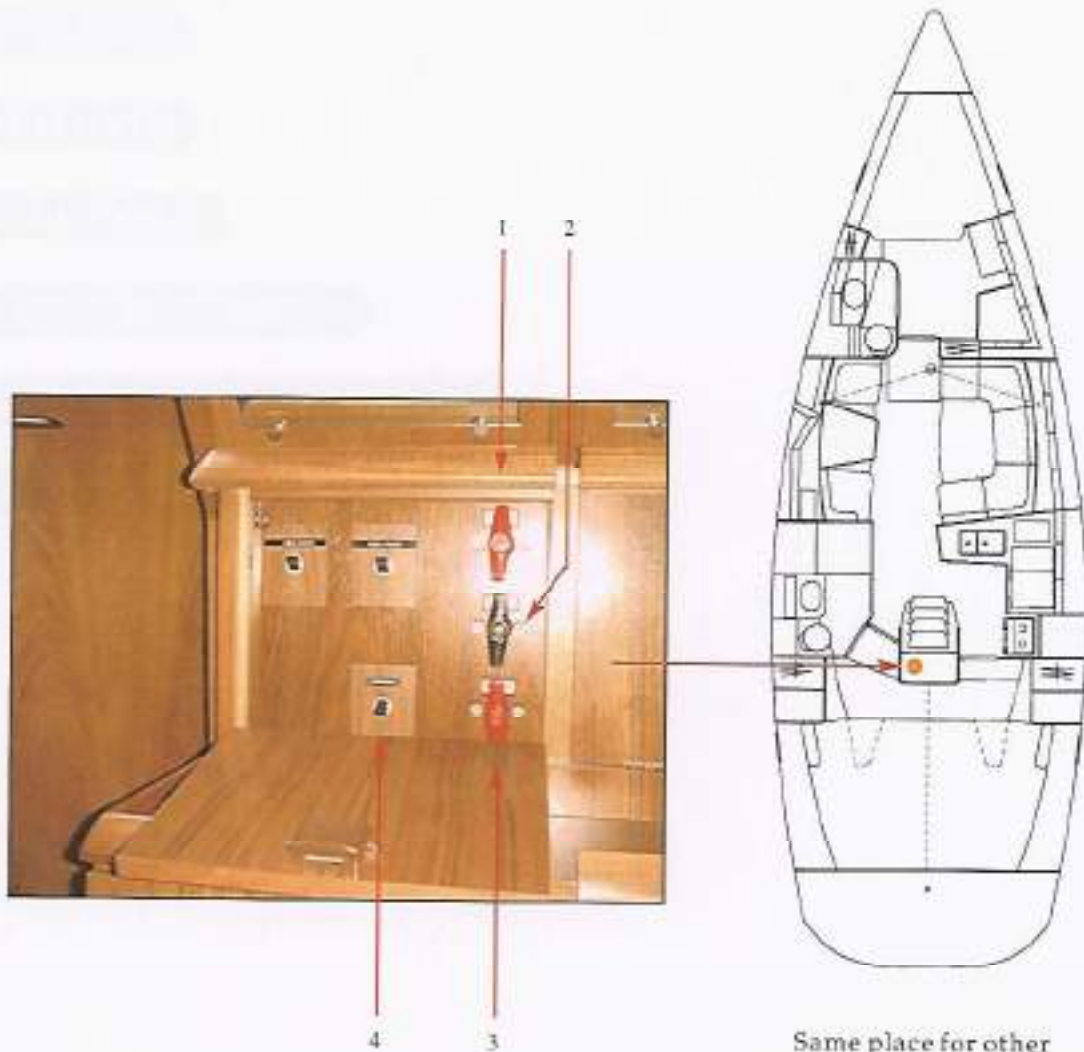

Same place for other accomodation versions

- 1- Battery master switch : + Domestic
- 2- Battery master switch : -
- 3- Battery master switch : + Engine
- 4- Windlass circuit breaker



## BATTERY MASTER SWITCHES

Electric installation : 12V DC.

The circuits can be used simultaneously or separately should the need arise.

Turn the master switches on to energize the system.

The master switches energize the engine and house electrical systems.

## PRECAUTION

Shut all master switches if the boat is unattended.

## BATTERIES

The engine driven generator is used to charge the batteries.

Use your battery charger (optional extra) during shore stay in order to sail off with properly charged batteries.

Never drained beyond 70% of the rating, to ensure a satisfactory service life.

Always check the condition of both the batteries and the loading system before you set sail.

## RECOMMENDATION / MAINTENANCE

- Keep the batteries clean and dry to obviate premature wear.
- Check regularly the electrolyte and top up with distilled water if required.
- Check the acid degree in the battery after extended idle time.
- Secure and smear regularly the terminals with petroleum jelly.
- Disconnect the batteries and remove them for the winter storage or when they are not used for a long time.



## OPERATION

The electrical switchboard does not require any routine maintenance.

### PRECAUTION

Never leave the boat unattended when the electrical system is energized, except for automatic switch bilge pump and protection circuits against fire or robbery.

Disconnect the 220V before opening the electrical switchboard

In case an electrical unit should not be energized, check :

- The main power supply (batteries, master switches),
- The switches and fuses along the line,
- The relevant electrical unit.

### WARNING

Never work on a live electrical fitting.

Use the automatic reset switch to read the fuel gauge, to obviate electrolytic problems.

### PRECAUTION

Only a technician, skilled in marine electricity, is entitled to alter a fitting and the relevant diagrams.

Never change or alter the amperage of the overcurrent safety devices.

Never install or replace the electrical appliances or equipments by components exceeding the circuit amperage (Watt for bulbs).

## 220V CIRCUIT

As far as possible, use electrical appliances with a double insulation or three conductors. Connect the casings or metallic cases of the fitted electrical appliances to the earth of the boat : this conductor is green with yellow stripes.

wiring





SHORE POWER PLUG

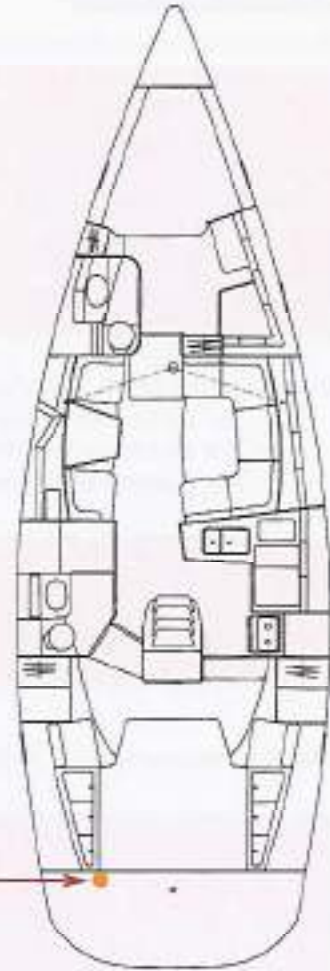



## SHORE POWER CABLE

### DANGER

Never let the end of the shore power cable hang in the water. It may entail an electric field liable to hurt or kill people swimming close by.



### PRECAUTION

- In order to reduce the risks of electric shock and fire :
- Switch off the electric panel connected to the shore power plug on shore before you connect or disconnect the shore power cable.
  - Connect the shore power cable in the boat before you plug it in the power point on shore.
  - Disconnect the shore power cable first on shore side then close tightly the power point on shore.
  - Do not change the connections of the shore power cable.

## MAST HARNESS CONNECTION

Connect the harness after installation of the mast.  
Access to the harness can be gained through the pillar boxing in the forward cabin, after inserting them in the cables outlets in front of the mast step.

## ELECTRONICS

Special sleeves are available to complement the boat's equipment (refer to drawing).  
Never install electronic instruments or repeaters less than 1.50m away from the radio loudspeakers.





# SUN ODYSSEY 43DS

## SCHEMATIC ELECTRICAL SYSTEM

### WATER ELECTRICITY

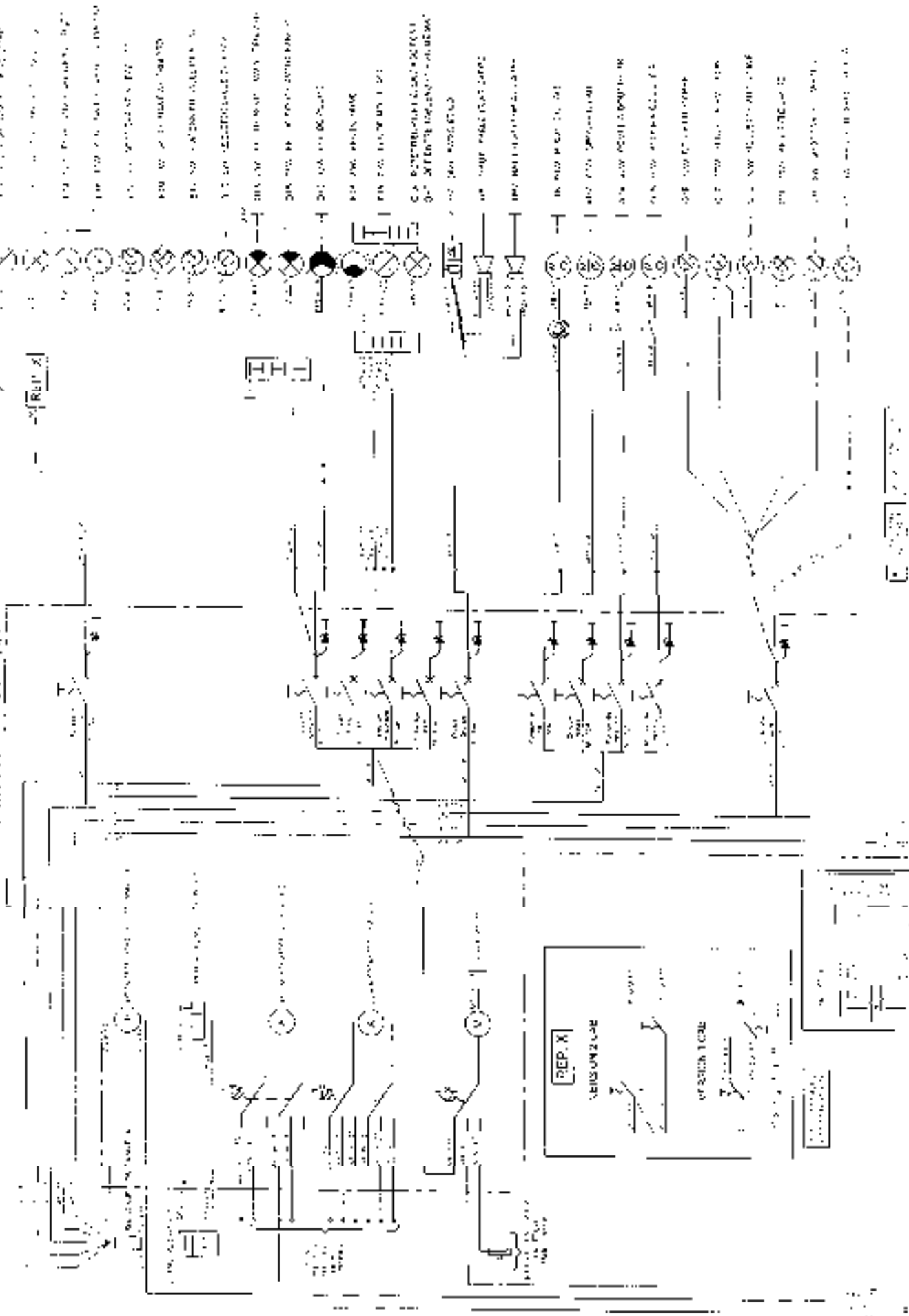

- 1. 12V DC - 10A - 12V DC
- 2. 12V DC - 10A - 12V DC
- 3. 12V DC - 10A - 12V DC
- 4. 12V DC - 10A - 12V DC
- 5. 12V DC - 10A - 12V DC
- 6. 12V DC - 10A - 12V DC
- 7. 12V DC - 10A - 12V DC
- 8. 12V DC - 10A - 12V DC
- 9. 12V DC - 10A - 12V DC
- 10. 12V DC - 10A - 12V DC
- 11. 12V DC - 10A - 12V DC
- 12. 12V DC - 10A - 12V DC
- 13. 12V DC - 10A - 12V DC
- 14. 12V DC - 10A - 12V DC
- 15. 12V DC - 10A - 12V DC
- 16. 12V DC - 10A - 12V DC
- 17. 12V DC - 10A - 12V DC
- 18. 12V DC - 10A - 12V DC
- 19. 12V DC - 10A - 12V DC
- 20. 12V DC - 10A - 12V DC
- 21. 12V DC - 10A - 12V DC
- 22. 12V DC - 10A - 12V DC
- 23. 12V DC - 10A - 12V DC
- 24. 12V DC - 10A - 12V DC
- 25. 12V DC - 10A - 12V DC
- 26. 12V DC - 10A - 12V DC
- 27. 12V DC - 10A - 12V DC
- 28. 12V DC - 10A - 12V DC
- 29. 12V DC - 10A - 12V DC
- 30. 12V DC - 10A - 12V DC
- 31. 12V DC - 10A - 12V DC
- 32. 12V DC - 10A - 12V DC
- 33. 12V DC - 10A - 12V DC
- 34. 12V DC - 10A - 12V DC
- 35. 12V DC - 10A - 12V DC
- 36. 12V DC - 10A - 12V DC
- 37. 12V DC - 10A - 12V DC
- 38. 12V DC - 10A - 12V DC
- 39. 12V DC - 10A - 12V DC
- 40. 12V DC - 10A - 12V DC
- 41. 12V DC - 10A - 12V DC
- 42. 12V DC - 10A - 12V DC
- 43. 12V DC - 10A - 12V DC
- 44. 12V DC - 10A - 12V DC
- 45. 12V DC - 10A - 12V DC
- 46. 12V DC - 10A - 12V DC
- 47. 12V DC - 10A - 12V DC
- 48. 12V DC - 10A - 12V DC
- 49. 12V DC - 10A - 12V DC
- 50. 12V DC - 10A - 12V DC
- 51. 12V DC - 10A - 12V DC
- 52. 12V DC - 10A - 12V DC
- 53. 12V DC - 10A - 12V DC
- 54. 12V DC - 10A - 12V DC
- 55. 12V DC - 10A - 12V DC
- 56. 12V DC - 10A - 12V DC
- 57. 12V DC - 10A - 12V DC
- 58. 12V DC - 10A - 12V DC
- 59. 12V DC - 10A - 12V DC
- 60. 12V DC - 10A - 12V DC
- 61. 12V DC - 10A - 12V DC
- 62. 12V DC - 10A - 12V DC
- 63. 12V DC - 10A - 12V DC
- 64. 12V DC - 10A - 12V DC
- 65. 12V DC - 10A - 12V DC
- 66. 12V DC - 10A - 12V DC
- 67. 12V DC - 10A - 12V DC
- 68. 12V DC - 10A - 12V DC
- 69. 12V DC - 10A - 12V DC
- 70. 12V DC - 10A - 12V DC
- 71. 12V DC - 10A - 12V DC
- 72. 12V DC - 10A - 12V DC
- 73. 12V DC - 10A - 12V DC
- 74. 12V DC - 10A - 12V DC
- 75. 12V DC - 10A - 12V DC
- 76. 12V DC - 10A - 12V DC
- 77. 12V DC - 10A - 12V DC
- 78. 12V DC - 10A - 12V DC
- 79. 12V DC - 10A - 12V DC
- 80. 12V DC - 10A - 12V DC
- 81. 12V DC - 10A - 12V DC
- 82. 12V DC - 10A - 12V DC
- 83. 12V DC - 10A - 12V DC
- 84. 12V DC - 10A - 12V DC
- 85. 12V DC - 10A - 12V DC
- 86. 12V DC - 10A - 12V DC
- 87. 12V DC - 10A - 12V DC
- 88. 12V DC - 10A - 12V DC
- 89. 12V DC - 10A - 12V DC
- 90. 12V DC - 10A - 12V DC
- 91. 12V DC - 10A - 12V DC
- 92. 12V DC - 10A - 12V DC
- 93. 12V DC - 10A - 12V DC
- 94. 12V DC - 10A - 12V DC
- 95. 12V DC - 10A - 12V DC
- 96. 12V DC - 10A - 12V DC
- 97. 12V DC - 10A - 12V DC
- 98. 12V DC - 10A - 12V DC
- 99. 12V DC - 10A - 12V DC
- 100. 12V DC - 10A - 12V DC

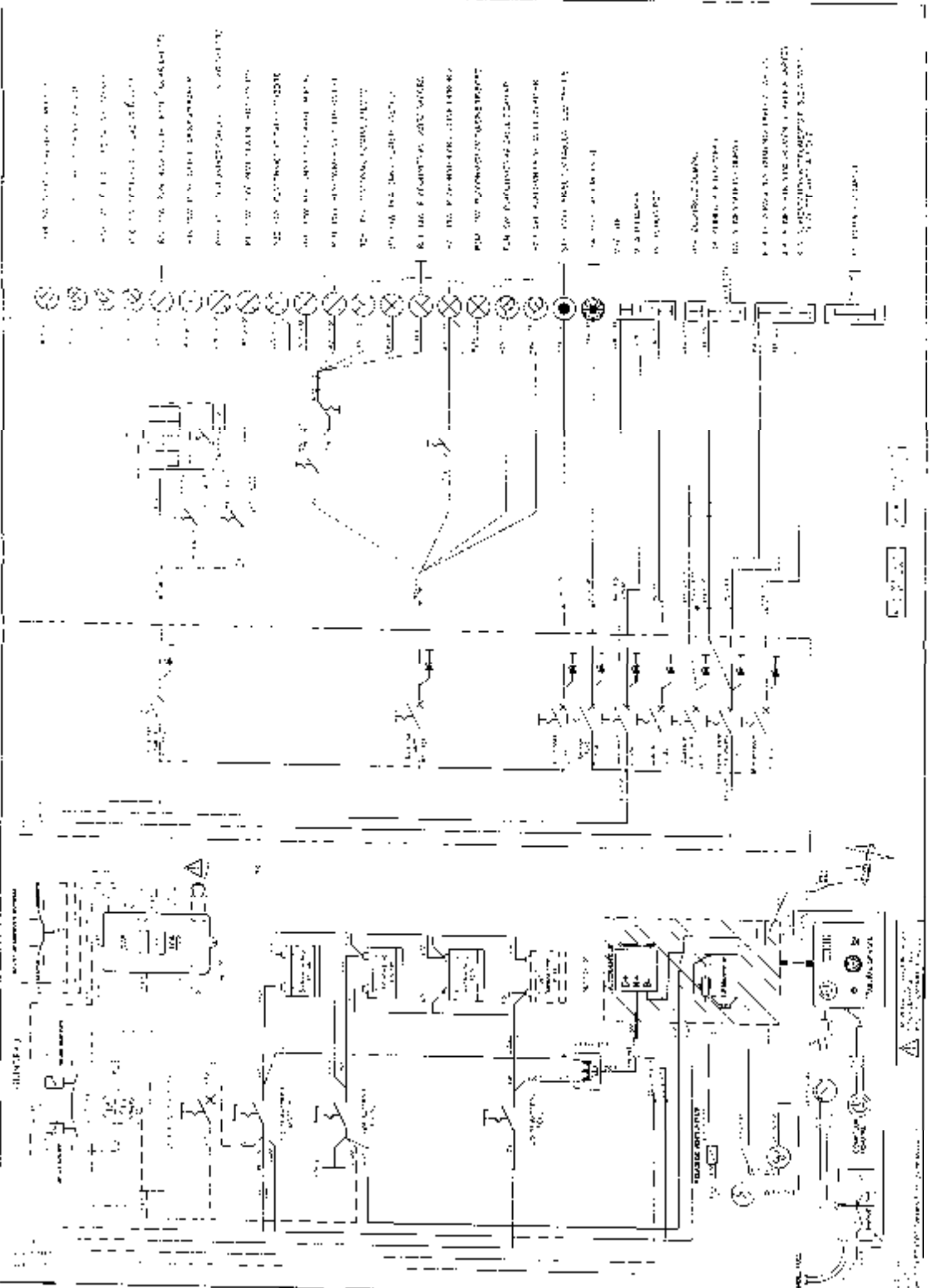

- 1. ENGINE ELECTRICAL SYSTEM
- 2. BATTERY ELECTRICAL SYSTEM
- 3. LIGHTS AND SIGNALS
- 4. WIRING DIAGRAM
- 5. ENGINE ELECTRICAL SYSTEM
- 6. BATTERY ELECTRICAL SYSTEM
- 7. LIGHTS AND SIGNALS
- 8. WIRING DIAGRAM
- 9. ENGINE ELECTRICAL SYSTEM
- 10. BATTERY ELECTRICAL SYSTEM
- 11. LIGHTS AND SIGNALS
- 12. WIRING DIAGRAM
- 13. ENGINE ELECTRICAL SYSTEM
- 14. BATTERY ELECTRICAL SYSTEM
- 15. LIGHTS AND SIGNALS
- 16. WIRING DIAGRAM
- 17. ENGINE ELECTRICAL SYSTEM
- 18. BATTERY ELECTRICAL SYSTEM
- 19. LIGHTS AND SIGNALS
- 20. WIRING DIAGRAM
- 21. ENGINE ELECTRICAL SYSTEM
- 22. BATTERY ELECTRICAL SYSTEM
- 23. LIGHTS AND SIGNALS
- 24. WIRING DIAGRAM
- 25. ENGINE ELECTRICAL SYSTEM
- 26. BATTERY ELECTRICAL SYSTEM
- 27. LIGHTS AND SIGNALS
- 28. WIRING DIAGRAM
- 29. ENGINE ELECTRICAL SYSTEM
- 30. BATTERY ELECTRICAL SYSTEM
- 31. LIGHTS AND SIGNALS
- 32. WIRING DIAGRAM
- 33. ENGINE ELECTRICAL SYSTEM
- 34. BATTERY ELECTRICAL SYSTEM
- 35. LIGHTS AND SIGNALS
- 36. WIRING DIAGRAM
- 37. ENGINE ELECTRICAL SYSTEM
- 38. BATTERY ELECTRICAL SYSTEM
- 39. LIGHTS AND SIGNALS
- 40. WIRING DIAGRAM
- 41. ENGINE ELECTRICAL SYSTEM
- 42. BATTERY ELECTRICAL SYSTEM
- 43. LIGHTS AND SIGNALS
- 44. WIRING DIAGRAM
- 45. ENGINE ELECTRICAL SYSTEM
- 46. BATTERY ELECTRICAL SYSTEM
- 47. LIGHTS AND SIGNALS
- 48. WIRING DIAGRAM
- 49. ENGINE ELECTRICAL SYSTEM
- 50. BATTERY ELECTRICAL SYSTEM
- 51. LIGHTS AND SIGNALS
- 52. WIRING DIAGRAM
- 53. ENGINE ELECTRICAL SYSTEM
- 54. BATTERY ELECTRICAL SYSTEM
- 55. LIGHTS AND SIGNALS
- 56. WIRING DIAGRAM
- 57. ENGINE ELECTRICAL SYSTEM
- 58. BATTERY ELECTRICAL SYSTEM
- 59. LIGHTS AND SIGNALS
- 60. WIRING DIAGRAM
- 61. ENGINE ELECTRICAL SYSTEM
- 62. BATTERY ELECTRICAL SYSTEM
- 63. LIGHTS AND SIGNALS
- 64. WIRING DIAGRAM
- 65. ENGINE ELECTRICAL SYSTEM
- 66. BATTERY ELECTRICAL SYSTEM
- 67. LIGHTS AND SIGNALS
- 68. WIRING DIAGRAM
- 69. ENGINE ELECTRICAL SYSTEM
- 70. BATTERY ELECTRICAL SYSTEM
- 71. LIGHTS AND SIGNALS
- 72. WIRING DIAGRAM
- 73. ENGINE ELECTRICAL SYSTEM
- 74. BATTERY ELECTRICAL SYSTEM
- 75. LIGHTS AND SIGNALS
- 76. WIRING DIAGRAM
- 77. ENGINE ELECTRICAL SYSTEM
- 78. BATTERY ELECTRICAL SYSTEM
- 79. LIGHTS AND SIGNALS
- 80. WIRING DIAGRAM
- 81. ENGINE ELECTRICAL SYSTEM
- 82. BATTERY ELECTRICAL SYSTEM
- 83. LIGHTS AND SIGNALS
- 84. WIRING DIAGRAM
- 85. ENGINE ELECTRICAL SYSTEM
- 86. BATTERY ELECTRICAL SYSTEM
- 87. LIGHTS AND SIGNALS
- 88. WIRING DIAGRAM
- 89. ENGINE ELECTRICAL SYSTEM
- 90. BATTERY ELECTRICAL SYSTEM
- 91. LIGHTS AND SIGNALS
- 92. WIRING DIAGRAM
- 93. ENGINE ELECTRICAL SYSTEM
- 94. BATTERY ELECTRICAL SYSTEM
- 95. LIGHTS AND SIGNALS
- 96. WIRING DIAGRAM
- 97. ENGINE ELECTRICAL SYSTEM
- 98. BATTERY ELECTRICAL SYSTEM
- 99. LIGHTS AND SIGNALS
- 100. WIRING DIAGRAM

# SUN ODYSSEY 43DS

INSTALLATION DE LA TV 1000 - 1008

N°	PIÉCE	DESCRIPTION	REMARQUE	ESTIMATION	REMARQUE
1	1000	TV 1000	TV 1000	1000	TV 1000
2	1001	1001	1001	1001	1001
3	1002	1002	1002	1002	1002
4	1003	1003	1003	1003	1003
5	1004	1004	1004	1004	1004
6	1005	1005	1005	1005	1005
7	1006	1006	1006	1006	1006
8	1007	1007	1007	1007	1007
9	1008	1008	1008	1008	1008
10	1009	1009	1009	1009	1009
11	1010	1010	1010	1010	1010
12	1011	1011	1011	1011	1011
13	1012	1012	1012	1012	1012
14	1013	1013	1013	1013	1013
15	1014	1014	1014	1014	1014
16	1015	1015	1015	1015	1015
17	1016	1016	1016	1016	1016
18	1017	1017	1017	1017	1017
19	1018	1018	1018	1018	1018
20	1019	1019	1019	1019	1019
21	1020	1020	1020	1020	1020
22	1021	1021	1021	1021	1021
23	1022	1022	1022	1022	1022
24	1023	1023	1023	1023	1023
25	1024	1024	1024	1024	1024
26	1025	1025	1025	1025	1025
27	1026	1026	1026	1026	1026
28	1027	1027	1027	1027	1027
29	1028	1028	1028	1028	1028
30	1029	1029	1029	1029	1029
31	1030	1030	1030	1030	1030
32	1031	1031	1031	1031	1031
33	1032	1032	1032	1032	1032
34	1033	1033	1033	1033	1033
35	1034	1034	1034	1034	1034
36	1035	1035	1035	1035	1035
37	1036	1036	1036	1036	1036
38	1037	1037	1037	1037	1037
39	1038	1038	1038	1038	1038
40	1039	1039	1039	1039	1039
41	1040	1040	1040	1040	1040
42	1041	1041	1041	1041	1041
43	1042	1042	1042	1042	1042
44	1043	1043	1043	1043	1043
45	1044	1044	1044	1044	1044
46	1045	1045	1045	1045	1045
47	1046	1046	1046	1046	1046
48	1047	1047	1047	1047	1047
49	1048	1048	1048	1048	1048
50	1049	1049	1049	1049	1049
51	1050	1050	1050	1050	1050
52	1051	1051	1051	1051	1051
53	1052	1052	1052	1052	1052
54	1053	1053	1053	1053	1053
55	1054	1054	1054	1054	1054
56	1055	1055	1055	1055	1055
57	1056	1056	1056	1056	1056
58	1057	1057	1057	1057	1057
59	1058	1058	1058	1058	1058
60	1059	1059	1059	1059	1059
61	1060	1060	1060	1060	1060
62	1061	1061	1061	1061	1061
63	1062	1062	1062	1062	1062
64	1063	1063	1063	1063	1063
65	1064	1064	1064	1064	1064
66	1065	1065	1065	1065	1065
67	1066	1066	1066	1066	1066
68	1067	1067	1067	1067	1067
69	1068	1068	1068	1068	1068
70	1069	1069	1069	1069	1069
71	1070	1070	1070	1070	1070
72	1071	1071	1071	1071	1071
73	1072	1072	1072	1072	1072
74	1073	1073	1073	1073	1073
75	1074	1074	1074	1074	1074
76	1075	1075	1075	1075	1075
77	1076	1076	1076	1076	1076
78	1077	1077	1077	1077	1077
79	1078	1078	1078	1078	1078
80	1079	1079	1079	1079	1079
81	1080	1080	1080	1080	1080
82	1081	1081	1081	1081	1081
83	1082	1082	1082	1082	1082
84	1083	1083	1083	1083	1083
85	1084	1084	1084	1084	1084
86	1085	1085	1085	1085	1085
87	1086	1086	1086	1086	1086
88	1087	1087	1087	1087	1087
89	1088	1088	1088	1088	1088
90	1089	1089	1089	1089	1089
91	1090	1090	1090	1090	1090
92	1091	1091	1091	1091	1091
93	1092	1092	1092	1092	1092
94	1093	1093	1093	1093	1093
95	1094	1094	1094	1094	1094
96	1095	1095	1095	1095	1095
97	1096	1096	1096	1096	1096
98	1097	1097	1097	1097	1097
99	1098	1098	1098	1098	1098
100	1099	1099	1099	1099	1099
101	1100	1100	1100	1100	1100
102	1101	1101	1101	1101	1101
103	1102	1102	1102	1102	1102
104	1103	1103	1103	1103	1103
105	1104	1104	1104	1104	1104
106	1105	1105	1105	1105	1105
107	1106	1106	1106	1106	1106
108	1107	1107	1107	1107	1107
109	1108	1108	1108	1108	1108
110	1109	1109	1109	1109	1109
111	1110	1110	1110	1110	1110
112	1111	1111	1111	1111	1111
113	1112	1112	1112	1112	1112
114	1113	1113	1113	1113	1113
115	1114	1114	1114	1114	1114
116	1115	1115	1115	1115	1115
117	1116	1116	1116	1116	1116
118	1117	1117	1117	1117	1117
119	1118	1118	1118	1118	1118
120	1119	1119	1119	1119	1119
121	1120	1120	1120	1120	1120
122	1121	1121	1121	1121	1121
123	1122	1122	1122	1122	1122
124	1123	1123	1123	1123	1123
125	1124	1124	1124	1124	1124
126	1125	1125	1125	1125	1125
127	1126	1126	1126	1126	1126
128	1127	1127	1127	1127	1127
129	1128	1128	1128	1128	1128
130	1129	1129	1129	1129	1129
131	1130	1130	1130	1130	1130
132	1131	1131	1131	1131	1131
133	1132	1132	1132	1132	1132
134	1133	1133	1133	1133	1133
135	1134	1134	1134	1134	1134
136	1135	1135	1135	1135	1135
137	1136	1136	1136	1136	1136
138	1137	1137	1137	1137	1137
139	1138	1138	1138	1138	1138
140	1139	1139	1139	1139	1139
141	1140	1140	1140	1140	1140
142	1141	1141	1141	1141	1141
143	1142	1142	1142	1142	1142
144	1143	1143	1143	1143	1143
145	1144	1144	1144	1144	1144
146	1145	1145	1145	1145	1145
147	1146	1146	1146	1146	1146
148	1147	1147	1147	1147	1147
149	1148	1148	1148	1148	1148
150	1149	1149	1149	1149	1149
151	1150	1150	1150	1150	1150
152	1151	1151	1151	1151	1151
153	1152	1152	1152	1152	1152
154	1153	1153	1153	1153	1153
155	1154	1154	1154	1154	1154
156	1155	1155	1155	1155	1155
157	1156	1156	1156	1156	1156
158	1157	1157	1157	1157	1157
159	1158	1158	1158	1158	1158
160	1159	1159	1159	1159	1159
161	1160	1160	1160	1160	1160
162	1161	1161	1161	1161	1161
163	1162	1162	1162	1162	1162
164	1163	1163	1163	1163	1163
165	1164	1164	1164	1164	1164
166	1165	1165	1165	1165	1165
167	1166	1166	1166	1166	1166
168	1167	1167	1167	1167	1167
169	1168	1168	1168	1168	1168
170	1169	1169	1169	1169	1169
171	1170	1170	1170	1170	1170
172	1171	1171	1171	1171	1171
173	1172	1172	1172	1172	1172
174	1173	1173	1173	1173	1173
175	1174	1174	1174	1174	1174
176	1175	1175	1175	1175	1175
177	1176	1176	1176	1176	1176
178	1177	1177	1177	1177	1177
179	1178	1178	1178	1178	1178
180	1179	1179	1179	1179	1179
181	1180	1180	1180	1180	1180
182	1181	1181	1181	1181	1181
183	1182	1182	1182	1182	1182
184	1183	1183	1183	1183	1183
185	1184	1184	1184	1184	1184
186	1185	1185	1185	1185	1185
187	1186	1186	1186	1186	1186
188	1187	1187	1187	1187	1187
189	1188	1188	1188	1188	1188
190	1189	1189	1189	1189	1189
191	1190	1190	1190	1190	1190
192	1191	1191	1191	1191	1191
193	1192	1192	1192	1192	1192
194	1193	1193	1193	1193	1193
195	1194	1194	1194	1194	1194
196	1195	1195	1195	1195	1195
197	1196	1196	1196	1196	1196
198	1197	1197	1197	1197	1197
199	1198	1198	1198	1198	1198
200	1199	1199	1199	1199	1199

## LEGENDE TV 1000

SYMBOLE	DESCRIPTION	REMARQUE	REMARQUE
1	VENTILATEUR	1	1
2	ANTENNE ELECTRONIQUE FM	2	2
3	MICROPROCESSEUR TV	3	3
4	PLAS	4	4
5	RECHARGEUR A CHARGE	5	5
6	EMBT	6	6
7	BOUCLE	7	7
8	CONSEILS DE RESS	8	8
9	SERIE DE DISPOSITIF	9	9
10	RECHARGEUR	10	10
11	RECHARGEUR	11	11
12	RECHARGEUR	12	12
13	RECHARGEUR	13	13
14	RECHARGEUR	14	14
15	RECHARGEUR	15	15
16	RECHARGEUR	16	16









SLAN COYNSSEY 43DM  
 TOURS VERSIONS  
 2010-2011-2012-2013-2014

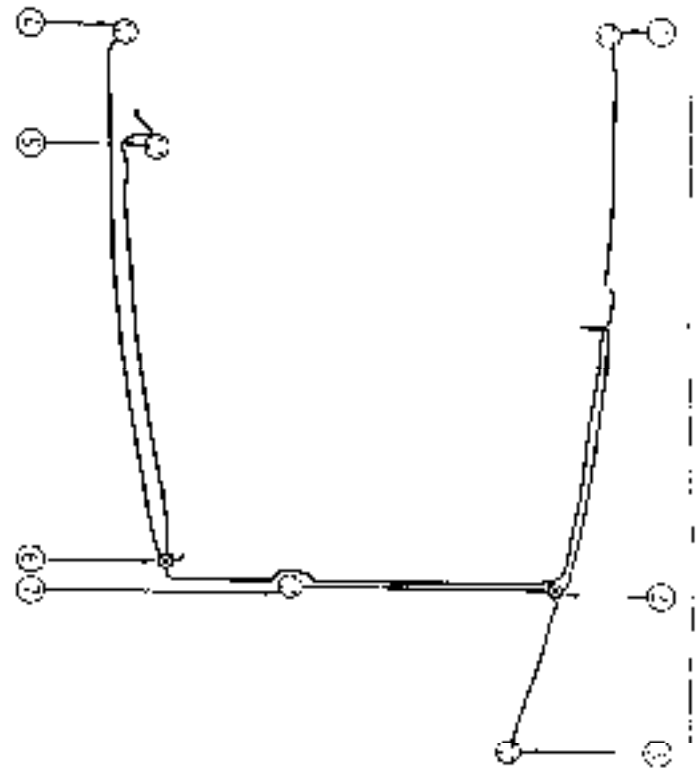

REMARQUEZ  
 LES LIEUX  
 MARQUÉS

REMARQUEZ  
 LES LIEUX  
 MARQUÉS

REF.	DESCRIPTION	QUANTITE	REMARQUES
1	SIÈGE DE HELM	1	
2	TABLE DE HELM	1	
3	RETOUR DE SIÈGE DE HELM	1	
4	COUSSIN DE SIÈGE DE HELM	1	
5	BASE DE SIÈGE DE HELM	1	
6	BASE DE RETOUR DE SIÈGE DE HELM	1	
7	TÔTE DE RETOUR DE SIÈGE DE HELM	1	
8	SOUS-TÔTE DE RETOUR DE SIÈGE DE HELM	1	
9	CÔTÉ DE RETOUR DE SIÈGE DE HELM	1	
10	FRONT DE RETOUR DE SIÈGE DE HELM	1	
11	ARRIÈRE DE RETOUR DE SIÈGE DE HELM	1	
12	GAUCHE DE RETOUR DE SIÈGE DE HELM	1	
13	DROITE DE RETOUR DE SIÈGE DE HELM	1	
14	FRONT-GAUCHE DE RETOUR DE SIÈGE DE HELM	1	
15	FRONT-DROITE DE RETOUR DE SIÈGE DE HELM	1	
16	ARRIÈRE-GAUCHE DE RETOUR DE SIÈGE DE HELM	1	
17	ARRIÈRE-DROITE DE RETOUR DE SIÈGE DE HELM	1	





# SUN ODYSSEY 43DS

## INSTALLATION ELECTRIQUE 115V AC

N°	REPERE	DESIGNATION
1	D2B	PRISE BABORD CABINE AR
2	D2A	PRISE DIFFERENTIELLE SALLE D'EAU AR
3	D3A	PRISE DIFFERENTIELLE SALLE D'EAU AV
4	D3B	PRISE CABINE AV
5	D1C	PRISE TRIBORD CABINE AR
6	D1B	PRISE CUISINE
7	D3C	PRISE CABINE LATRALE
8	A	PRISE DE CUA
9	A	DISJONCTEUR DIFFERENTIEL
10	C	CHARGEUR BATTERIE 25A (Option)
11		BORNIER AR TABLEAU
12		TABLEAU ELECTRIQUE
13	D2C	PRISE TABLE A CARTES
14	B	CHAUFFE - EAU
15	D1D	PRISE DIFFERENTIELLE CARRÉ TRIBORD

### LEGENDE 115V AC USA

	PRISE DIFFERENTIEL 10mA (USA)
	PRISE ET PRISE DE CUA
	BOITE DE DERIVATION
	CHARGEUR DE BATTERIE - OPTION
	DISJONCTEUR DIFFERENTIEL 30mA
	TABLEAU ELECTRIQUE
	CHAUFFE - EAU

### REPERAGE DES FILS

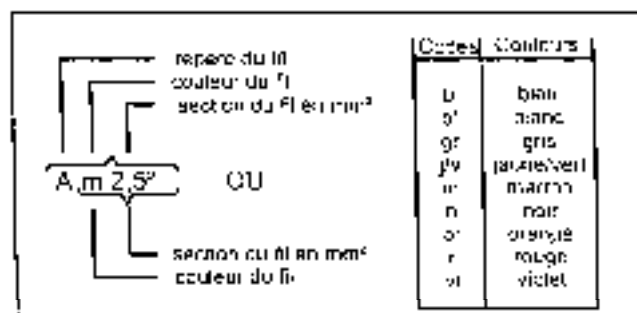

OLD-21/12-08  
S-43DS-F-18-A

Fichier: F-16-SO43DS\_Legende\_dfil

SI-MOTORSYSTEME  
 700001100000  
 700001100000  
 700001100000

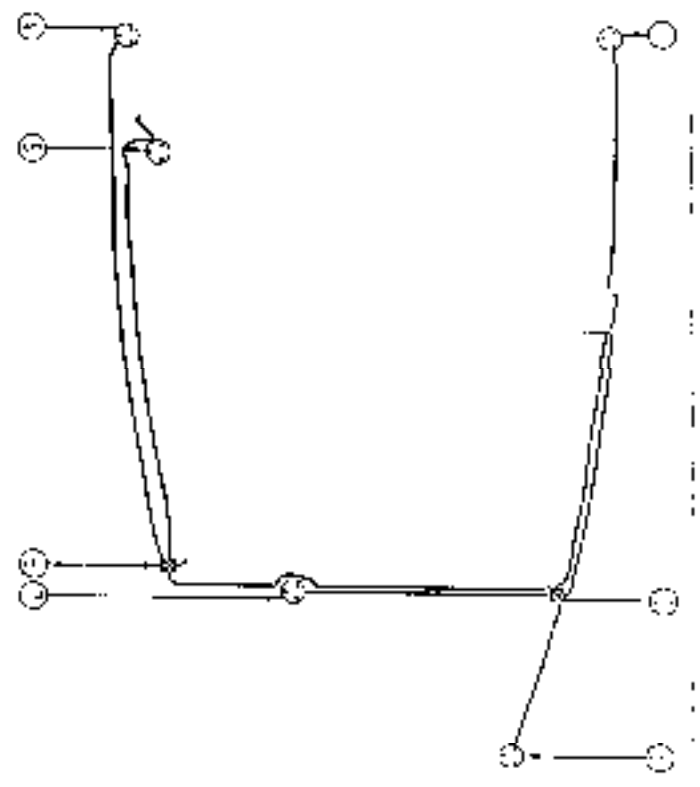

SI-MOTORSYSTEME  
 700001100000



SI-MOTORSYSTEME  
 700001100000

Part No.	Description	QTY	Unit
700001100000	SI-MOTORSYSTEME	1	PCB
700001100000	SI-MOTORSYSTEME	1	PCB
700001100000	SI-MOTORSYSTEME	1	PCB







SI-MOTORSYSTEME  
 700001100000  
 700001100000

# SUN ODYSSEY 43DS

## INSTALLATION ELECTRIQUE 230V AC

N°	REPERE	DESIGNATION
1	D3B	PRISE BABORD CARINE AR
2	D3A	DERIVATION SALLE D'EAU AV
3	D3B	PRISE CARINE AV
4	D1C	PRISE TRIBORD CABINE AR
5	D1D	PRISE CUISINE
6	D1A	DERIVATION CARRÉ TRIBORD
7	D3C	PRISE CABINE LATÉRALE
8	A	PRISE DE QUAI
9		CHARGEUR BATTERIE 35A (Option)
10	D2A	DERIVATION SALLE D'EAU AR
11	A	DISJONCTEUR DIFFÉRENTIEL
12		CORNIER AR TABLEAU
13		TABLEAU ÉLECTRIQUE
14	D2C	PRISE TABLE À CARTES
15	D1B	PRISE MICRO-ONDE (Option)
16	B	CHAUFFE-EAU
17	D1D	PRISE CARRÉ TRIBORD

## LEGENDE 230V AC

	PRISE DIFFÉRENTIEL 10mA (ISA)
	PRISE ET PRÉSE DE QUAI
	BOÎTE DE DERIVATION
	CHARGEUR DE BATTERIE - OPTION
	DISJONCTEUR DIFFÉRENTIEL 30mA
	TABLEAU ÉLECTRIQUE
	CHAUFFE-EAU

## REPERAGE DES FILS

Code	Couleur
L	bleu
N	blanc
Ø	gris
Ø	jaune-vert
M	noir
N	rouge
Ø	orange
Ø	rouge
Ø	noir

	<p>noyau du fil section du fil en mm²</p> <p>OU</p> <p>section du fil en mm² couleur du fil</p>
---	---

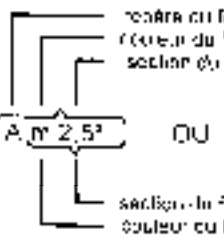
01/07/12/99  
S04303-F-10-A

Fichier: F-15-S043DS Legende dit





# SUN ODYSSEY 43DS

SYSTEME ELECTRIQUE 230V AC

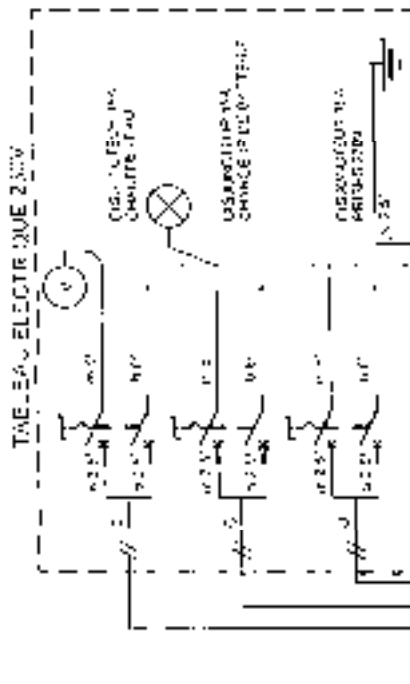

BOITE DE DERIVATION  
A B C D E F G H I J K L M N O P Q R S T U V W X Y Z

DISJONCTEUR 10A  
DIFFERENTIEL 30mA

- A 4x40W/230V-230V-TERRE
- B 1200W/230V-230V
- C SYSTEME CHARGES/BATTERIE

BOITE DE JERONISATION  
A B C D E F G H I J K L M N O P Q R S T U V W X Y Z

BOITE 230V 230V

BOITE 100V 100V

BOITE 230V 230V

BOITE 230V 230V

BOITE 230V 230V

BOITE 230V 230V

BOITE 230V 230V

BOITE 230V 230V

BOITE 230V 230V

BOITE 230V 230V

BOITE 230V 230V

BOITE 230V 230V

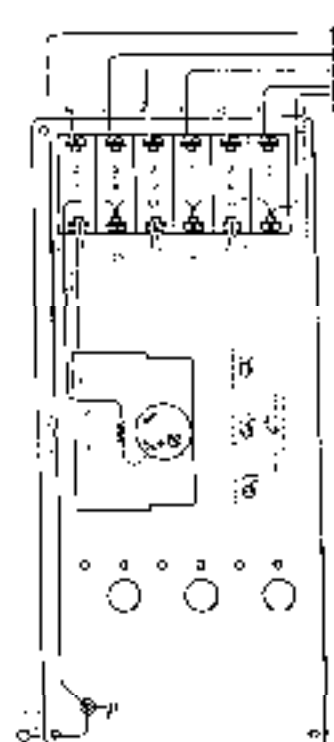

BOITE DE DERIVATION

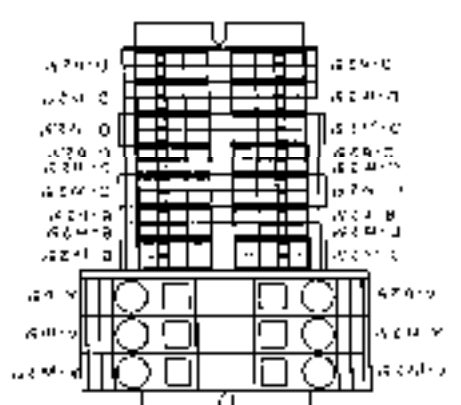
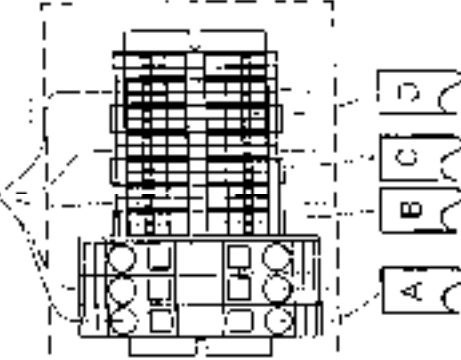





SUN ODYSSEY 43DS  
Toutes Versions

INSTALLATION OF THE T-SPIN™  
TSA 10.9.11.1.01.0001.0001

INSTALLATION POINT  
TSA 10.9.11.1.01.0001.0001

INSTALLATION POINT  
TSA 10.9.11.1.01.0001.0001

TYPE	INSTALLATION POINT
VERSION	TSA 10.9.11.1.01.0001.0001
DATE	2011.09.11

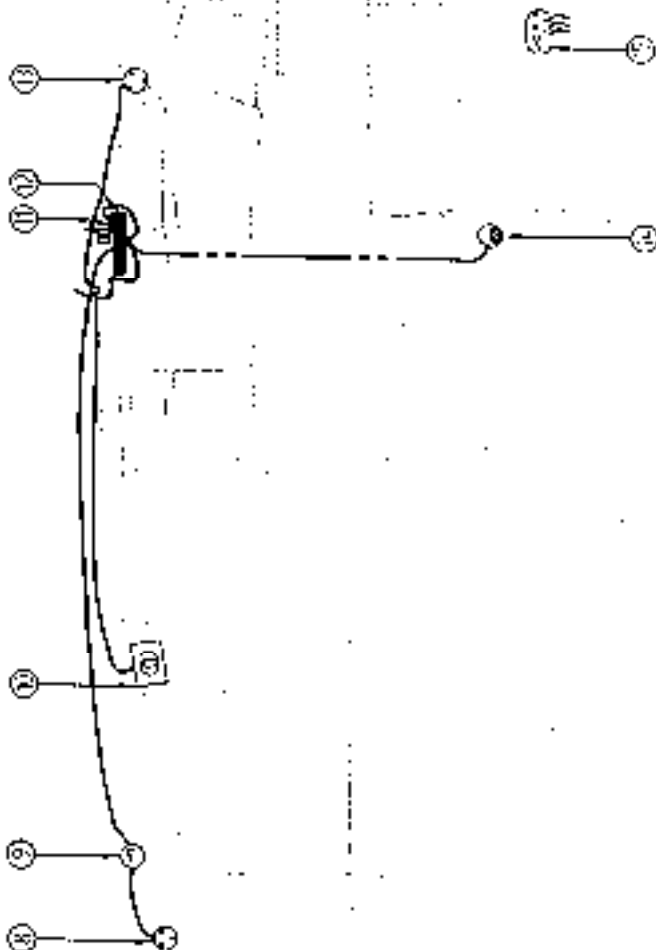
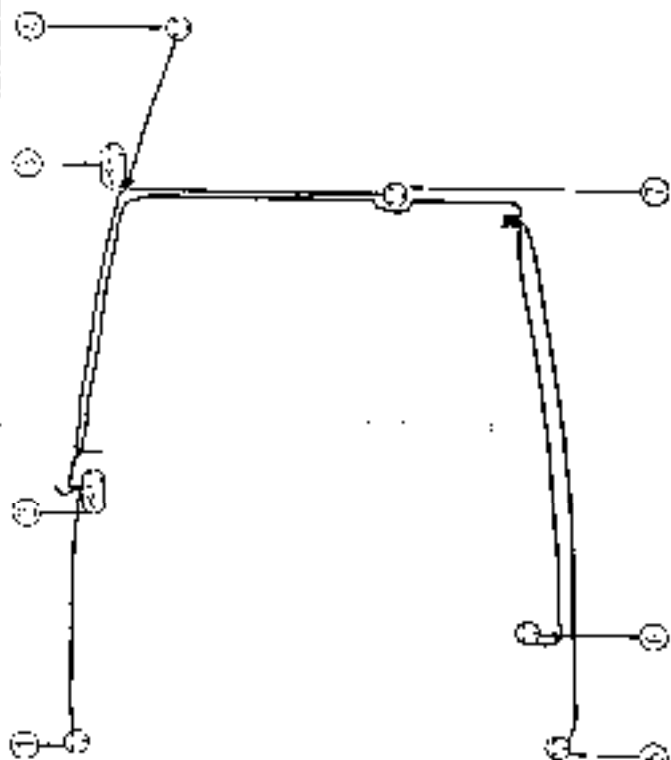

MAN O'WAR SYSTEMS

FORUMS: VERNIER.COM

MAN O'WAR SYSTEMS

MAN O'WAR SYSTEMS

MAN O'WAR SYSTEMS

1	2	3	4	5	6	7	8	9	10	11	12	13	14	15	16	17	18	19	20	21	22	23	24	25	26	27	28	29	30	31	32	33	34	35	36	37	38	39	40	41	42	43	44	45	46	47	48	49	50	51	52	53	54	55	56	57	58	59	60	61	62	63	64	65	66	67	68	69	70	71	72	73	74	75	76	77	78	79	80	81	82	83	84	85	86	87	88	89	90	91	92	93	94	95	96	97	98	99	100
---	---	---	---	---	---	---	---	---	----	----	----	----	----	----	----	----	----	----	----	----	----	----	----	----	----	----	----	----	----	----	----	----	----	----	----	----	----	----	----	----	----	----	----	----	----	----	----	----	----	----	----	----	----	----	----	----	----	----	----	----	----	----	----	----	----	----	----	----	----	----	----	----	----	----	----	----	----	----	----	----	----	----	----	----	----	----	----	----	----	----	----	----	----	----	----	----	----	----	-----

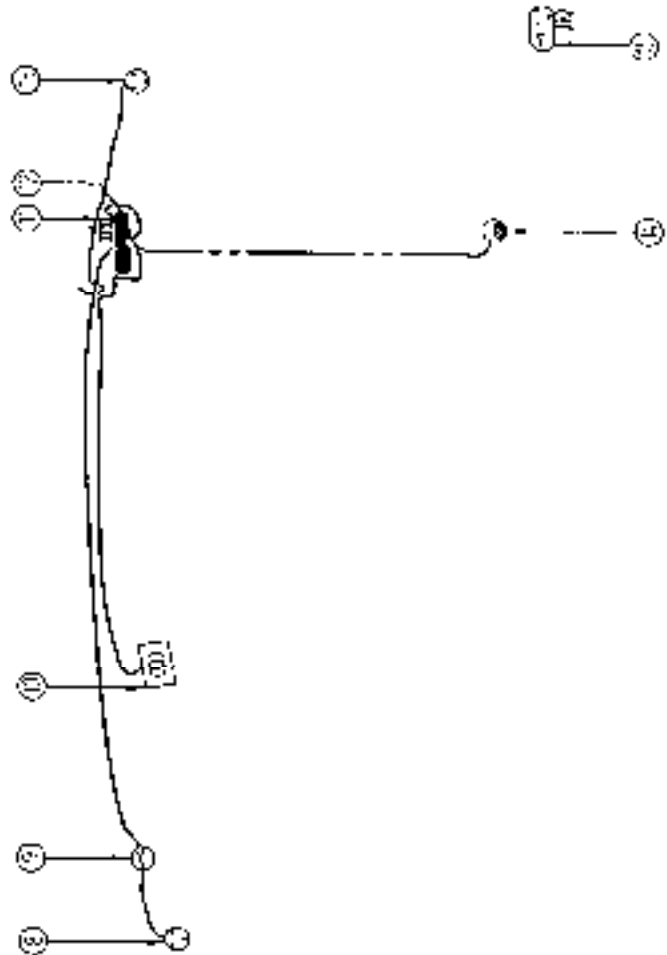
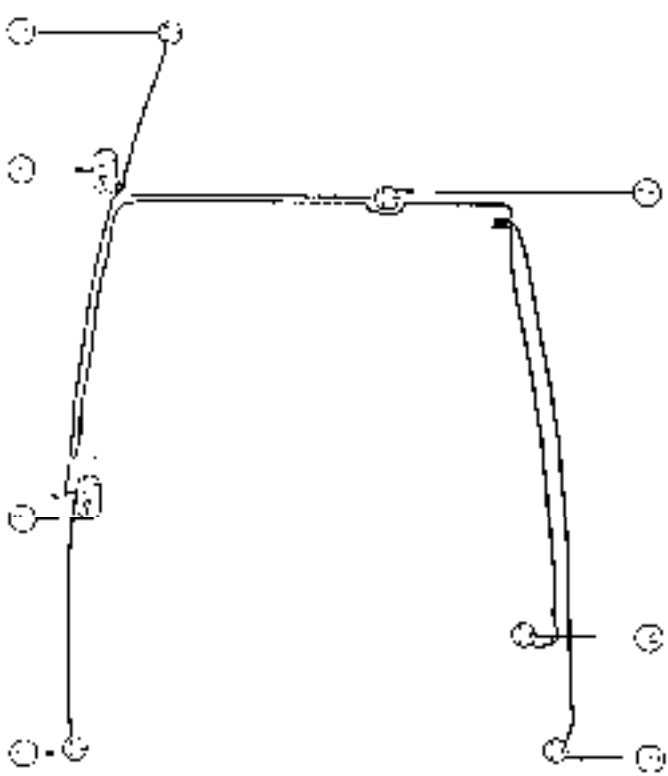

# DIESEL ENGINE



FUEL TANK

FUEL FILTER

FUEL CIRCUIT VALVE

ENGINE

DASH BOARD / CONTROL LEVER

STUFFING BOX

PROPELLER

ANODE

## ENGINE INSTALLATION

- 1- Fuel circuit valve
- 2- Tank
- 3- Deck filler
- 4- First-stage filter
- 5- Engine seacock
- 6- Sea water filter
- 7- Exhaust muffler
- 8- Blower
- 9- Exhaust pipe
- 10- Vent
- 11- Engine compartment air exhaust
- 12- Engine compartment air intake
- 13- Fuel return hose

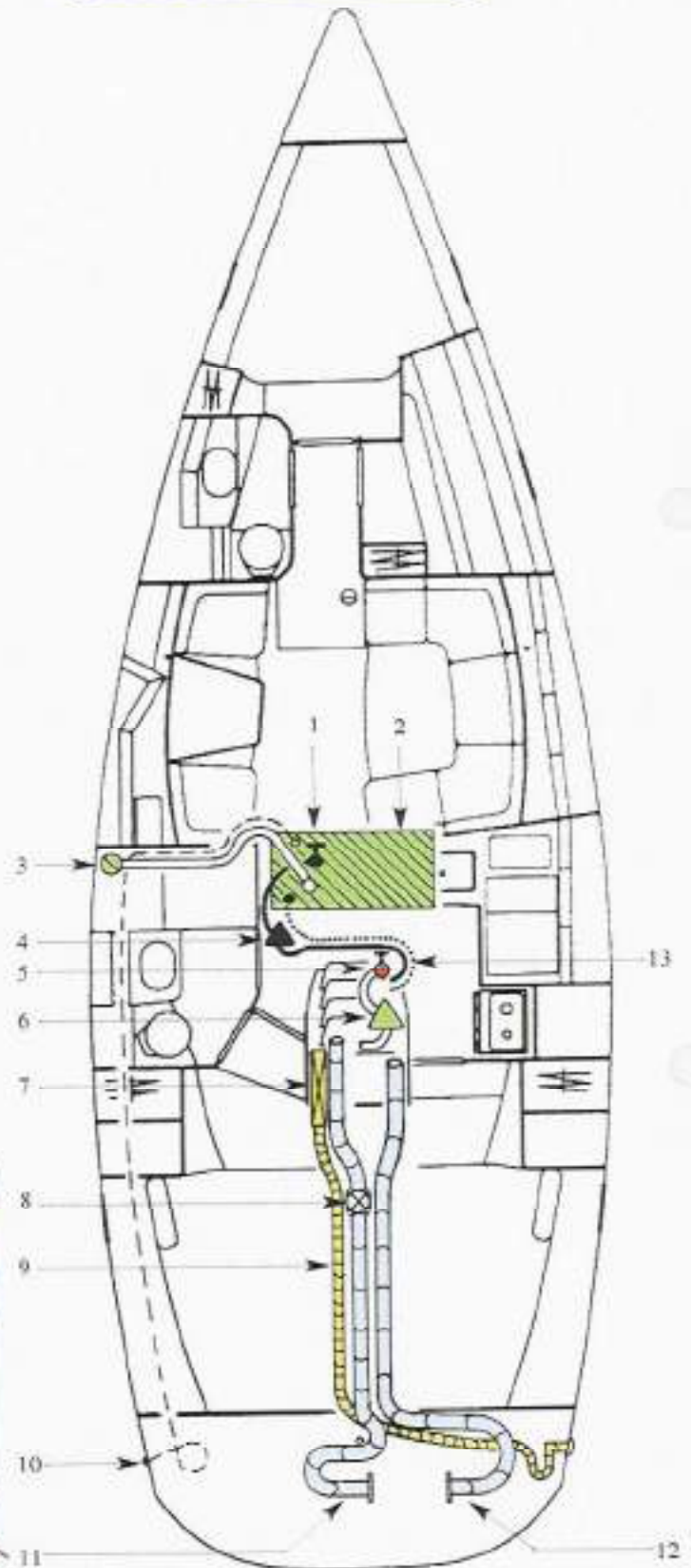
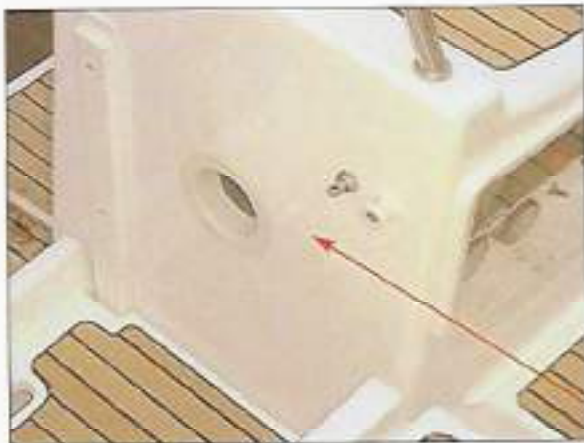

Same place for other accomodation versions





## FUEL TANK

### TANK FILLING :

Comply with the general precautions indicated in chapter 7 for tank filling.  
To protect the deck from possible fuel splashes, wet up the area around the deck filler with sea water before taking the plug off. In case of splashes, rinse the deck liberally (after fitting the filler plug back in place).

## DANGER

During fuel tank filling, the engine must be stopped and smoking must be prohibited.



diesel engine

### RECOMMENDATIONS / MAINTENANCE

- Check regularly the filler plug O-ring for conditions to prevent water ingress,
- Don't shut the fuel valve after every utilization, except before an extended unattended period,
- Ensure that the tank is full up to maximum, to avoid condensation,
- Clean the tank every five years to remove sludge deposits.



Same place for other  
accomodation versions



## FUEL FILTER

Engine running problems may have several causes, amongst which dirty fuel is a major one, and the injection pump will be soon destroyed by water in the fuel.

Water results either from the condensation in an insufficiently filled tank, or seeps in through the mislocked filler plug or through a damaged seal.

The fuel is run via two filters to control the foregoing risks :

- One filter is integral with the engine to ensure fine fuel filtration (refer to the engine brochure to find out the filter renewal frequency and maintenance work),
- The other one is a first-stage filter located in the pipe system between the engine and the fuel tank.

Undo (but do not remove) the knurled screw at the base of the settling bowl, allow to flow into a tray until clean, water free fuel appears. Purge the system several times a year. Remove the bowl for access to the first-stage filter, which should be replaced at least once a year.

## FUEL CIRCUIT VALVE

See chapter 2 for Fight against Fire

### DANGER

Never obstruct the ways to the fuel valve.

diesel engine



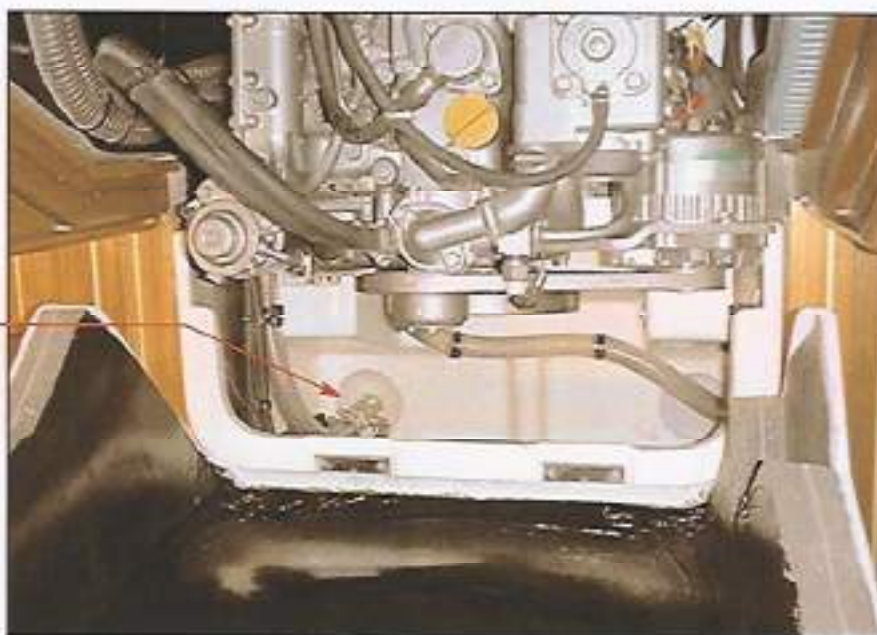

- 1 - Cooling water filter
- 2 - Seacock with valve, engine sea water intake



## ENGINE

Refer to the brochure supplied with the boat.

You must read carefully the brochure which includes detailed hints about the engine operation and how to run it properly.

### PRECAUTION

Never run the engine if the boat is dry-docked.

#### ACCESS TO THE ENGINE :

Access to the engine via the companionway panel.  
Lateral trap doors give access to the principal instruments.

#### ENGINE SEA VALVE :

The engine sea valve ensures a critical duty in the engine operation and, therefore, the strainer must be brushed whenever the ship is docked and kept clean and free from clogging or anti-fouling paint.

The sea valve must be open before starting the engine, otherwise the exhaust and the engine may incur severe damages.

#### RECOMMENDATIONS

Good practice requires to check if water is expelled together with the exhaust gases, immediately after starting the engine; otherwise, stop the engine immediately and check the valve for cleanliness.

It's not necessary to shut the valve after each use of the engine; on the other hand, this is mandatory if the boat remains unmanned for a long period of time.



## ENGINE OPERATION :

Before starting the engine :

- Open the fuel valve,
- Open the engine cooling valve,
- Actuate the battery master switch to energize the electrical system,
- Before starting the engine, disengage the reversing gear to accelerate from dead stop,
- Refer to the engine manufacturer's brochure before starting up the engine.

### PRECAUTION

Don't turn off or de-energize the electrical system while the engine is running.  
If your boat's diesel engine is fitted with a stop pull,  
this must be actuated before using the ignition key to switch off.

## DIESEL :

- Refill before the fuel tanks are depleted to prevent the fuel system from running dry,
- Before sailing be sure to have enough fuel.

### RECOMMENDATIONS / MAINTENANCE

Refer to the manufacturer's brochure supplied with the boat.  
Look after all eventual risk of oil or fuel leaks. Check the exhaust gaz colors.

### DASH BOARD / CONTROL LEVER

All engine controls are located on the dash board, which does not require any special precautions (refer to engine brochure).

Check the accelerator and clutch cables (lubricate the spacers and fork ends).

### RECOMMENDATIONS / SAILING

Avoid making noise and waves near other users when the boat is engine-powered;  
Respect speed-limits.  
Set the lever Astern to lock the propeller when sailing.

diesel engine



**Access for owner's aft cabin version:**  
Open the engine trap door and lift the floor trap.

**Access for 2 aft cabins version:**  
Dismantle the central bulkhead before lifting the floor trap (see procedure page 35-back).



Same place for other accommodation versions



## STUFFING BOX

Lubricate the seal every 200 running hours, or at least once a year with 1cm<sup>3</sup> of lubricant. After launching, discharge the air from the sleeve by pinching with fingers.

## PROPELLER

The propeller supplied with your boat embodies the results of tests carried out jointly with the engine manufacturer.

## PRECAUTION

Don't change the propeller without specialist's advise.

## ANODE

### RECOMMENDATIONS

Check regularly the anode on the propeller for corrosion and renew as required. Check and replace the "hydrolube" oil ring if necessary.

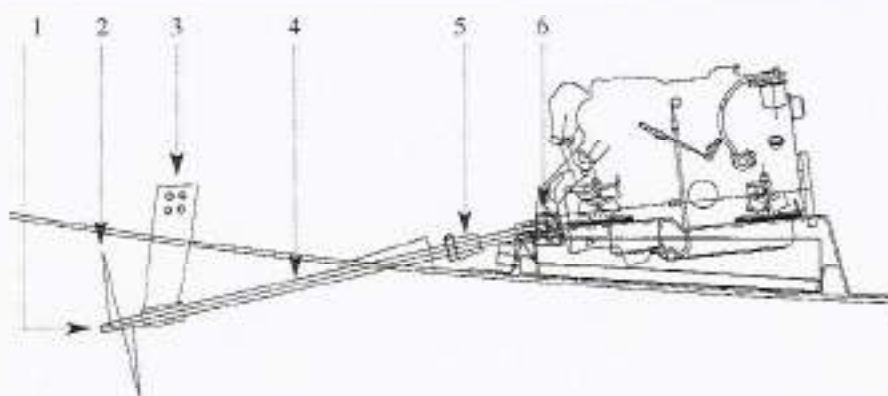

- |               |                 |
|---------------|-----------------|
| 1- Anode      | 4- Shaft tube   |
| 2- Propeller  | 5- Stuffing box |
| 3- Shaft seat | 6- Connecting   |



5.2, 5.3, 5.4, Iso 10240

# LAUNCHING



LAUNCHING HINTS

MAST INSTALLATION



## LAUNCHING HINTS

A lot of skill and care is required to launch your Jeanneau boat for the first time, since the satisfactory operation of all equipment will depend on the quality of many launching steps.

Therefore, the initial launching and tests of various equipment shall be performed by your Jeanneau agent or distributor, so you can claim the warranty in case of equipment failure.

The following precautions are required in case you should launch your ship yourself :

### BEFORE LAUNCHING :

- If the boat is fitted with a lock and speedometer, install the relevant fittings,
- Check the suction strainer for cleanliness,
- Check the reduction gear and engine oil level (refer to the engine maintenance manual). The engine cooling water drain corks must be shut,
- All optional accessories must be sealed off with paste,
- Retract the speedometer in its housing (this can be damaged by the handling belt),
- On-line engines: ensure that the node is in place and the nut is properly locked (the lock-washer must be folded back on the nut). The anode should not be painted,
- All sea suction and discharge valves must be shut (sink, wash basin, closets, engine).

### HOISTING :

- Install a rope forward and a rope aft and fenders as necessary,
- Before hoisting, ensure that the belts will not crush the locks, speedometers, shafts, etc...

To that effect, mark the belt position (adhesive tape on the moulding) for hoisting after launching (most boats are already fitted with the stickers).

The crane hook shall be fitted with a gantry or spreader with two belts. Under no circumstances shall the belts be hooked directly on the hook as this would result in excessive compressive stresses on the hull.

- Hoist up gently and control the boat moves with the ropes.

## WARNING

Don't stay on-board or under the boat during hoisting.





#### AFTER LAUNCHING :

- Check the speedometer and lock fittings for tightness, as the case may be,
- Open and check the valves for sealing with the hull and relevant pipe,
- Check the stuffing box for sealing (refer to section 8 "Stuffing box"),
- Before starting the engine, refer to chapter 8 "Engine".

#### MAST INSTALLATION

Refer to chapter 5 «Rig and Sails».



5.3, 5.4, 5.5, no 10240

# LAYING UP AND WINTER PRECAUTIONS



LAYING UP

PROTECTION & MAINTENANCE

Index 0

55  
58



There are two winter precautions procedures :

### 1- LAYING UP

Take ashore all ship's documents, loose ropes not used for mooring, galley equipment, stores, clothes, safety equipment, battery.

Mark up the safety equipment and check the expire dates; obtain immediate overhaul of the raft (Easter is the deadline after which it will be too late !).

Draw up a complete inventory of the ship's equipment.

### 2- PROTECTION AND MAINTENANCE

#### INSIDE :

- Drain all fresh water pipes and rinse with a solution of vinegar and water (don't use chlorine-based products) or protect the pipes with food-grade anti-freeze,
- Lubricate and shut all sea water valves and sea-cocks, rinse and drain the closets in full,
- Retract the loch and speedometer heads, seal-off air inlets and install a dehydrator in the saloon and leave all doors open (cabins, lockers, wardrobes, iceboxes),
- Leave the cushions in the outside for a long time and re-install in the boat in upright position to limitate contact surfaces.

#### OUTSIDE :

- Rinse liberally the hull, deck, lubricate all mobile and mechanical components with petroleum jelly (locks, hinges, bolts, etc.),
- Protect all surfaces from chafing ropes, mooring lines ,
- Protect the boat with fenders and ensure that the lines are taut.

The above hints are not a comprehensive check-list; your Jeanneau agent will be able to advise you and take care of the boat maintenance.



---

## ENGINE:

Engine winter lay-up shall be performed by a professional organization, and will not be the same if the boat remains afloat or ashore.

The following are a few major tasks :

### Afloat :

- Drain the cooling system and fill up with anti-freeze,
- Switch off the master switch, lubricate the terminals with petroleum jelly and test the battery voltage,
- Change the anode,
- Fill the fuel tank to maximum to avoid condensation,
- Refer to the engine manual for everything concerning the engine.

### Ashore :

- Take the battery ashore and keep it under maintenance charging,
- Drain all cooling, lub oil, fuel oil and exhaust systems and perform winter precautions specified by the manufacturer, bearing in mind the fact that the freezing hazard is more significant if the boat is ashore,
- Remove and lubricate the sea-cocks included in the cooling systems, leave the sea-cocks open, check the hoses,
- Slack off the pumps and A.C. generators belts.

## PERSONAL NOTES



CHANTIERS JEANNEAU - BP 529 - 85505 LES HERBIERS cedex - FRANCE  
Tel. (33) 02 51 64 20 20 - Fax : (33) 02 51 67 37 65  
3615 JEANNEAU ( 2,23F / mn) - Internet: <http://www.jeanneau.com/fr>.

ISO 9002  
certified  
AFAQ n°1994/2076

The present document is not contractual and constantly desiring to improve our models, we reserve the right to modify them without advance notice.  
Conception et réalisation: ELLCAS - NANTES - Impression Numérique : Goubault Imprimerie Nantes.

jeanneau recommande **IGOL**.

