



EdgeWater
POWER BOATS

Owner's Manual

135ST



EdgeWater

P O W E R B O A T S



135 ST



EdgeWater

POWER BOATS

Dear EdgeWater 135ST Owner:

Congratulations on purchasing one of the finest small boats ever built. It has been constructed with care from the finest available materials. At EdgeWater we take great pride in the quality and craftsmanship that goes into each boat, large or small. We believe you'll have many years of enjoyment from your new EdgeWater and thank you for entrusting your leisure time to one of our fine products.

This manual has been assembled to help you learn more about your new boat and increase your enjoyment of it. Your EdgeWater has been built for a "Lifetime on the Water".

Boat safe and boat smart, we wish you many years of boating pleasure.

Sincerely,

A handwritten signature in black ink, appearing to read "Peter Truslow". The signature is stylized and somewhat cursive.

Peter Truslow
President
EdgeWater Powerboats



EdgeWater

POWER BOATS

Service Information

Please fill out the information below completely. It will help us in assisting you in the event your EdgeWater needs service.

Customer Name _____

Address _____

City _____ State _____ Zip _____

Phone _____ Home _____ Office _____

Dealer Name _____

Address _____

City _____ State _____ Zip _____

Phone _____ Fax _____

Purchase Date _____ Engine Make/Model _____

Delivery Date _____ Engine Serial # _____

Hull Number DMA _____ Ignition Key # _____

Dougherty Marine Partnership, d.b.a. EdgeWater Powerboats reserves the right to make alterations in the standard and optional equipment without incurring obligation to those boats already having been built. Every effort has been made to ensure that the information in this manual accurately describes vessels being built at the date of printing.

Table of Contents

Chapter 1	General Information	13
1.1	General	13
1.2	Owner / Operator Responsibilities	13
Chapter 2	Helm Control Systems.....	15
2.1	General	15
2.2	Steering System	15
2.3	Engine Throttle and Shift Controls	15
Chapter 3	Propulsion System	17
3.1	General	17
3.2	Engine Cooling System	17
3.3	Propellers	18
3.4	Engine Power Tilt and Trim	18
3.5	Engine Instrumentation	19
Chapter 4	Fuel System	21
4.1	General	21
4.2	Fueling	21
4.3	Fuel System Maintenance	21
Chapter 5	Electrical System	23
5.1	General	23
5.2	Accessory Panel Switches	23
5.3	Electrical System Maintenance	23
Chapter 6	Drainage System	25
6.1	General	25
6.2	Drain System Maintenance	25
6.3	Cockpit Drains	25
6.4	Forward Storage Locker	25
Chapter 7	Safety Equipment	27
7.1	Required Safety Equipment	27
7.2	Suggested Safety Equipment - Inshore	28
Chapter 8	Safe Operation	29
8.1	Pre-Cruise Check List	29
8.2	Basic Rules of the Road	30
8.3	Safe Operation	31
8.4	Towing or Being Towed	32
8.5	Stopping the Boat	32
8.6	Docking	33

8.7 After Operation	33
8.8 Trailering Your Boat	33
8.9 Launching Your Boat	34
8.10 Retrieving Your Boat	35
Chapter 9 Routine Maintenance	37
9.1 Exterior Hull and Deck	37
9.2 Engine	38
Chapter 10 Exterior Equipment	39
10.1 Anchor Locker	39
Chapter 11 Seasonal Maintenance	41
12.1 Engine	41
12.2 Hull	41
12.3 Trailer	41
Appendix	43

1

General Information

1.1 General

The EdgeWater 135ST has been designed to be powered by a single outboard engine. If the outboard you chose is two-cycle, make sure to monitor oil level in the oil tank, located in the aft starboard locker.

Each outboard manufacturer provides manuals to carefully detail operation and maintenance of their products. Please read and observe the instructions set forth in your outboard manual.

1.2 Owner / Operator Responsibilities

Registration

Registering your boat is important to you. Federal Law requires that all powered, undocumented vessels be registered in their state of principal use. Contact the appropriate agency in your local state to obtain specific registration information.

Reporting Boating Accidents

All boating accidents must be reported to the proper authorities in the state which the accident occurred. If someone dies or disappears as a result of the recreational boating accident, it must be reported immediately, with a formal report being made within 48 hours. If there is damage of more than \$500, or if the boat is completely lost, a formal report must be made within 10 days.

A “Boating Accident Report” form is located in the back of this manual, and if you need additional information you may obtain it by calling the Boating Safety Hotline, 800-368-5647.

Education

Whether or not you are an experienced boater, attending a Boating Education Course can be beneficial. If you are inexperienced, it is the best, safest way to begin your life on the water. If you are an experienced boater, it's always good to sharpen your skills.

Required Equipment

The U.S. Coast Guard requires certain equipment on each boat. In addition, they also set minimum equipment and safety standards. For more detailed requirement information, obtain “Federal Requirements And Safety Tips For Recreational Boats”, by contacting the Boating Safety Hotline, 800-368-5647.



Some states and local agencies require equipment that is not required by the U.S. Coast Guard. Your local agency or dealer can provide specific information regarding these non-standard requirements.

2

Helm Control Systems

2.1 General

The helm station is the control center for the boat. The main control systems are the engine throttle and shift controls, the steering system, and the trim tab controls. These provide the operator the ability to control speed, direction, boat trim, and attitude. Each manufacturer provides manuals on the operation and use of their systems.



2.2 Steering System

General

The manual which comes with your steering system will provide specific information on your steering system.

The steering system for your EdgeWater 135ST is a state of the art “no-feedback” push-pull cable system. Turning the helm unit controls the movement of a large push-pull cable which moves the engine left or right controlling boat direction.

While running at slow speeds, most boats tend to wander slightly back and forth. Keeping the wheel in the center without overcompensating for the slight wandering will prevent over steering and reduce the tendency to wander.



To reduce the corrosion on the cable end, the engine should be turned to port when the boat will not be used for a long period of time. This protects the cable end, as it remains in the cable tube and is not exposed to the elements.

Steering System Maintenance

Routine system inspection should occur regularly. Cables, linkage and helm assemblies should be inspected for wear, corrosion, cracking, or deterioration. Cleaning and light grease should be applied to all exposed metal parts and other damaged or deteriorated parts should be replaced as soon as possible.

2.3 Engine Throttle and Shift Controls

Refer to the engine manual supplied with your engine for specific information on your controls. The ones depicted are those supplied by Yamaha.

Your EdgeWater 135ST comes only with a single engine. There are three major components of the engine throttle and shift controls: handles, throttle cable, shift cable. Throttle and shift cables are push-pull and are connected to the fuel system (carburetor or fuel injection) and the other to the shift rod linkage. By moving the handles forward and back, the operator engages the cables thus controlling the amount of fuel being used and the gear selector for forward, neutral and reverse. Careful use of the controls provides smooth, responsive and safe operation.

Chapter 2 Helm Control Systems



Do not bring the throttle back abruptly to stop the boat unless it is an emergency. Allow time for the engine rpm to come down to idle before shifting to reverse or severe gearbox damage could occur.

The control is generally in neutral when the lever is 90° to the control box. Moving the lever 15° forward will engage forward gear. Moving the lever 15° aft from center will engage reverse gear. There is usually a slight detent at the point where a gear is engaged.



When shifting from neutral to forward or reverse, the operator should always perform a brief pause to allow time for the gear box to engage in the proper gear at a minimum rpm. This pause will reduce gear clash and provide for longer gear life.

The levers should never be moved forward for back without the engine running, with the following exception. With the Yamaha control, pushing the center of the rubber plate on the left side of the control box disengages the gear shift and provides throttle only operation with the gear-box remaining in neutral. This provides additional throttle for cold starts or other warm-up operation.



Do not attempt to control adjustments unless you are very familiar with their function, operation and adjustment. Failure to properly adjust the system components can adversely affect your boat's performance and safety. Misadjustment can also cause severe control, engine or lower unit damage.

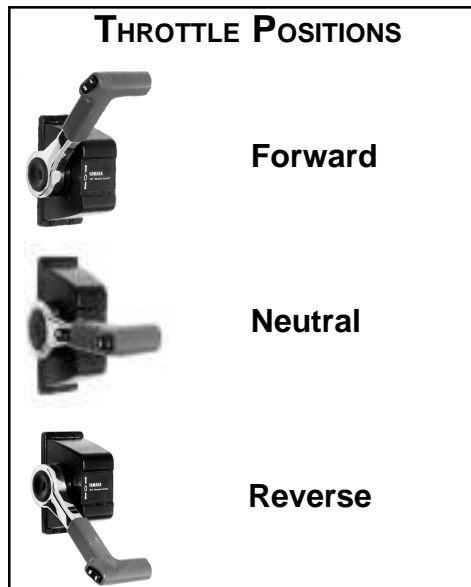

Each manufacturer's engine controls contain a neutral safety switch to prevent accidental starting with a gear engaged. The adjustment of this device should be done only by a certified technician. If the engine will not start in neutral, a slight movement of the control may be necessary to locate the actual "neutral" position of the neutral safety switch.



Engine Stop Switch

This device is designed to prevent the operator falling overboard while the engine remains running. The engine stop switch lanyard should always be worn by the operator, while the boat is in motion. Pulling the lanyard from the control will stop the engine. If the engine will not crank properly, the lanyard may not be properly attached to the engine stop switch.



Do not use the engine stop switch to stop the boat unless it is an emergency as it may impair your ability to quickly re-start the engine.

3

Propulsion System

3.1 General

Your new EdgeWater 135ST is designed to be powered by a single outboard motor. Most 2-cycle outboards currently use an automatic system to mix the oil with the gasoline before it is used by the engine. If equipped with a 2-cycle engine, there will be an oil tank in the aft, starboard locker. Make sure this tank always has a sufficient amount of the recommended 2-cycle oil for your cruise, plus some reserve. 4-cycle engines require oil be maintained in the crankcase. Always check the crankcase oil level before each day's run.



Always follow the manufacturer's recommendations and use only the recommended oil types.



Don't attempt to service your outboard or any of its components unless you are thoroughly familiar with its operation and dangers. Many of the moving part components are exposed and can pose an extreme danger to anyone unfamiliar with their operation. Always leave the servicing to a qualified technician.

Each manufacturer provides manuals designed to assist you in the proper operation and maintenance of your new engine. Follow their guidance and schedules for proper operation of your new engine. With a modern outboard there is little to do as long as proper maintenance is performed, in accordance with the manufacturer's recommendations. If the boat is to be kept in saltwater for an extended period, electrolysis and marine growth can become a problem. When leaving your boat in salt water overnight or for an extended period, tilt the engine as high out of the water as possible. This will decrease the possibility of marine growth on the outside of the engine, as well as reduce the potential of marine growth compromising the cooling water inlets in the lower unit, which can cause overheating.



Do not paint your outboard's lower unit with paints designed for boat hulls. Some can cause severe damage to your engine. Check with your engine manufacturer to get their recommendation.

Do not attempt to control adjustments unless you are very familiar with their function, operation and adjustment. Failure to properly adjust the system components can adversely affect your boat's performance and safety. Misadjustment can also cause severe control, engine or lower unit damage.



Please return all warranty cards for boat, engine and other related items. This will assist you in the event you have a warranty problem.

3.2 Engine Cooling System

Most outboard engines are cooled by water taken in through ports in the lower part of the drive section. Make sure these ports are free of debris or other items that might cause the flow to be restricted. Maintain a routine vigilance to see that the visual inspection streams have a steady flow of water. If they do not, shut down the engine to see if they are clogged or if there is a more serious problem. Be especially watchful if you have gone through an area of vegetation or shallow water as the intake ports can become

Chapter 3 Propulsion System



clogged with weeds, dirt or other debris.

Do not run your outboard without water coming into the lower unit. The water pump impeller can be damaged in only seconds of this type of operation.



3.3 Propellers

A turning propeller moves the boat through the water, forward or backward. They should always be clean and free from nicks or dings, which can adversely affect performance. Your dealer can assist you in the proper selection of a propeller for your boat. This selection is based on the horsepower of the engine and its relationship to the size and weight of the boat.

Propeller sizes are determined by two numbers, which appear on different propellers at various locations. They are listed in sequence, for example 13 x 17. The first number is the diameter of the propeller and the second is the pitch. Pitch is the theoretical distance the propeller moves through the water with each complete revolution. The larger the number the greater the theoretical movement. It also follows that the larger the number the greater horsepower is required to turn it. With a load which is “normal”, or usual for your boating activities, the engine should be able to reach its maximum operating RPM range at wide open throttle (WOT). With a light load on smooth water, the engine should reach its manufacturer’s rated maximum operating RPM at wide open throttle (WOT) and maximum trim. If it does not, you may have a propeller which has too much pitch. If it goes beyond the maximum recommended RPM range, you may have too little pitch. Neither condition is good for the engine. You will get shorter engine life and poorer performance than your boat and motor were designed to provide.



If your boat came from the factory with a propeller selected by EdgeWater, it should already be optimized for the performance of your boat. Before changing the pitch or diameter of your propeller always check with your dealer to determine how the changes will affect your boat and engine performance.

3.4 Engine Power Tilt and Trim

The power tilt and trim system on your outboard provides the ability to optimize the running angle of your EdgeWater 135ST to allow for load and sea conditions. Moving the outboard lower unit toward the transom is generally referred to as trimming “in”, while moving the outboard lower unit away from the transom is referred to as trimming “out”. It is generally best to have the engine trimmed in for acceleration from displacement to planning mode. This brings the bow down and requires less fuel and effort on the engine’s part to plane off the hull.

The first 20° of movement aft of the transom is referred to as trim and is the area generally used to operate the boat while on plane. The area beyond the first 20° is referred to as tilt and is usually reserved for operating in shallow water or pulling up on a beach. While running under normal conditions, the bow should be in a 3°



Engine Tilt



Max Trim



Tilt Under

EdgeWater 135ST

to 5° up angle to maximize the hull's ride and performance. When sea conditions are rougher than normal, bringing the bow slightly down may improve the ride and will also allow the boat to remain on plane at a lower speed.



Watch the hoses and cable on your engine as it is tilted to its full tilt position. They may become caught and damaged if the engine is in the wrong position.

3.5 Engine Instrumentation

The following is presented to familiarize you with the instruments, which may be on your boat. Every boat is not equipped with full instrumentation.



All factory installed Yamaha engines include Yamaha's digital multifunction tachometer and speedometer. Refer to your engine operators manual for use details.

Tachometer

The tachometer displays the number of revolutions per minute (RPM) the engine is turning. There is a designed operation RPM range for the engine. Become familiar with the operating range of your engine and its operating characteristics. The tachometer is designed to aid the boater to assure the engine performs within that designed range. The tachometer can be used to better understand the performance of your engine and your EdgeWater 135ST. By monitoring your tachometer as you operate your EdgeWater, you will find RPM ranges that work better in certain sea and load conditions. Be alert the tachometer operation may provide an early indication of difficulty, before it becomes irreversible.

Speedometer

The speedometer indicates the boat speed in miles per hour. Some types work using a spinning wheel to determine the boat speed. Their accuracy can vary from the actual over the bottom speed due to many factors. Other boat speedometers calculate the speed by amount of pressure the moving water forces into a "pitot" tube. These gauges should only be used as indicators of approximate speed and not used as absolute speed indicators.

Fuel Gauge

This gauge indicates the amount of fuel in the fuel tank. It is always prudent to follow the "rule of thirds", one-third of the tank to get the destination, one-third to return, and one-third in reserve.

This gauge is a measure of relative fuel supply and is not a calibrated instrument!

Engine Alarms

Most outboards are equipped with several audible engine alarms. Your engine owner's manual will familiarize you with these and their sometimes-distinctive sounds.

Warning: If an engine alarm sounds, shut down the engine until the source of the problem is determined.

Chapter 3 Propulsion System



Compass

The compass assists in determining your location by indicating your position relative to magnetic north. For accuracy, your compass may need to be adjusted to take into account specifics of your boat and geographic location. Please refer to the material provided with your compass for “compensation”.



Instrument Maintenance

Your instrument faces should be periodically cleaned to keep them free of salt and atmospheric debris. The ignition switches should be periodically sprayed with a contact cleaner/lubricant to keep them free of corrosion and dirt.

4

Fuel System

4.1 General



Your EdgeWater 135ST is designed to use a portable fuel tank.

If any odor of gasoline is detected, immediately shut off all engines and electrical devices until the source and condition of the odor has been determined and eliminated. Have a fire extinguisher at the ready until the condition has been resolved.

4.2 Fueling

Your EdgeWater 135ST is equipped with a portable fuel tank. Before fueling, you should follow these procedures.

- Make sure the boat is securely moored.
- Make sure all switches are off and all cigarettes are extinguished.
- Know the location of the fire extinguisher in case of an emergency.
- Remove the fuel tank from the boat.
- Remove the fuel fill cap.
- Place the nozzle firm against the side of the opening.
- Begin fueling.
- When the tank is full, stop fueling.
- Remove the fuel nozzle.
- Install the fuel cap.



- Place the fuel tank back in the boat.
- Check the area for fuel odors.

Warning: If fuel odors are detected, do not start the engine! Check to make certain there are no leaks or system problems before starting the engine.



Warning: Do not fill the fuel tank while the engine is running. Do not allow smoking or open flames within 50 ft. of the fueling area. Fuel is very flammable. To prevent damage to the engine, use only fuels without harsh additives or alcohol. Refer to your engine owner's manual for specific fuel requirements.

4.3 Fuel System Maintenance

Regularly inspect the fuel system components. All lines, fittings, and bulbs should be flexible and not corroded. If fittings or other components are found to be cracked, they should be replaced at once. If you use your boat infrequently or do not use it for an extended period of time, a fuel conditioner should be added to a full tank of fuel to prevent fuel deterioration and damage to the fuel system.

5

Electrical System

5.1 General

Your EdgeWater 135ST operates on a 12 volt DC system, similar to your automobile. The battery or batteries are typically lead acid type and require similar maintenance to your car's battery. An electrical schematic is included in the appendix for specific location of electrical components.



5.2 Accessory Panel Switches

Your EdgeWater 135ST is equipped with a panel breaker for the navigation lights.

5.3 Electrical System Maintenance

At the beginning and end of each season, the exposed electrical components of the switch panel should be sprayed with a non-conductive rust/corrosion inhibiting spray. Light bulb connections and running light connections should be covered with a non-water soluble lubricant. Care must be taken not to get grease on the glass portion of the lights as it will cause them to overheat and burn out. Inspect all wiring for breaks, loose terminals and sound insulation. Replace worn or deteriorated components. Check the electrolyte level in the batteries regularly and fill with distilled water, as necessary. **DO NOT OVERFILL.**

6

Drainage System

6.1 General

All water drains from your EdgeWater 135ST by gravity. Your boat is self-bailing at rest. It is important to check drains frequently to make sure they are clear and free flowing. Review the schematic in the Appendix and become familiar with the location of each thru-hull drain.

6.2 Drain System Maintenance

Essential tasks must be done periodically to maintain your boat's ability to drain in adverse conditions.

- Clean cockpit drains to remove debris or other foreign objects which could prevent boat from draining properly.
- Check bilge area for debris and foreign material, which can cause automatic switches to malfunction.
- Flush drains to keep free flowing and clean.

6.3 Cockpit Drains

Your EdgeWater 135ST drains aft thru two cockpit drains located in the aft corners of the cockpit. These exit the boat through the transom, using hoses to pass through the aft storage areas. The deck is designed to take water from other draining parts of the boat such as the forward lockers and cup-holders and drain it overboard. These should be checked periodically to make sure they are clear running and free from debris. When washing the boat down, after use, use a hose nozzle with a high pressure stream to make sure they are free running.

When the boat is out of the water it may be drained by a thru hull drain located at the bottom of the transom. This drain has a brass plug that may be removed with a ½" wrench. This plug should be periodically checked for tightness.

6.4 Forward Storage Locker

This locker is designed to drain to the cockpit sole.

7.1 Required Safety Equipment

Contact the U.S. Coast Guard Boating Safety Hotline at 1-800-368-5647, or 1-202-267-1070 to obtain a

7

Safety Equipment

pamphlet on the latest required and suggested safety equipment. The Coast Guard Auxiliary also offers “Courtesy Examinations” to help ensure your boat is properly equipped.

The following is a list of required safety equipment to be aboard your boat. This may be modified from time to time and it is suggested that you contact the U.S. Coast Guard Boating Safety Hotline at 800-368-5647 or pick up a copy of the latest “Federal Requirements and Safety Tips of Recreational Boats” pamphlet.

- **Personal Floatation Devices (PFD’s)**

These must bear a tag that they have been approved by the U.S. Coast Guard and must be in serviceable condition. They must also be of the appropriate size for the wearer, i.e. for children there must be children’s life vests on board. Many states now require children to wear PFD’s at all times. You should check with your state to determine the proper requirements. You should maintain at least one Type I, II, or III PFD for each person on board, plus one throwable device, a ring or boat cushion, Type IV.

- **Visual Distress Signals**

These are now required in virtually all waters of the United States. If in doubt, please check with the U.S. Coast Guard Boating Safety Hotline at 1-800-368-5647 for a specific answer.

- **Pyrotechnic Visual Distress Signals**

These must be U.S. Coast Guard approved, be in a serviceable condition, and be readily accessible. They each have a service life date and are not counted beyond this date. These types include both hand held flares and aerial flares.

- **Sound Signaling Device**

You must have an efficient means of making a proper sound signal in the event of distress or poor visibility. This may be a horn, whistle, or bell.

- **Navigation Lights**

These come with your EdgeWater and meet U.S. Coast Guard requirements. It is important that you periodically check to make sure they are in working order. It is very important these be checked prior to any cruise which will keep you on the water after dark.

- **Fire Extinguisher**

A fire extinguisher is standard on all EdgeWater boats. These require regular inspection to make certain they are ready for use. Questions may be directed to the U.S. Coast Guard Boating Safety Hotline at 1-800-368-5647, or 1-202-267-1070. You should, as part of routine boat maintenance, check to make sure your extinguisher is still operable.

Never discharge your fire extinguisher to see if it still works. This will cause it to lose pressure. If it is accidentally discharged or if it is used on a fire, replace it immediately.

7.2 Suggested Safety Equipment - Inshore



Suggested safety equipment, over and above the required equipment is:

Chapter 7 Safety Equipment

- First aid kit and manual
- Boat hook
- Tool kit
- Adequate number and size of line. Bow lines should be at least 1/3 longer than the boat's length and stern lines at least as long as the boat. When operating in areas with unusually high tidal range, this should be lengthened. The minimum size line for a small boat is 3/8" diameter 3 strand nylon. Refer to one of the listed references in the Appendix for a complete discussion on line size relative to boat length.
- Waterproof flashlight, with good batteries
- Spare batteries
- Spare boat keys
- Binoculars
- Tow line. This should be a minimum of 50' long with at least one size increase over the boat's mooring lines.
- Day/Night visual distress signals
- Local charts and compass
- Properly sized anchor and line
- Fenders of the proper size

Always carry water, even for a 10 minute cruise.

8.1 Pre-Cruise Check List



- Check provisions. Make sure you have plenty of water in the event you have a problem and are delayed.
- Check the weather forecast. Avoid sea conditions that are beyond the experience of yourself and your crew.

8

Safe Operation

- Do you have the correct safety gear aboard and is it in good working order?
- Make sure all fire extinguishers are in good working order.
- It is advisable to carry jackets or foul weather gear in the event of adverse weather conditions.

Your EdgeWater 135ST is equipped with a maximum capacity rating plate permanently affixed to the helm area of your boat. It will provide information regarding the maximum number of people you can safely have aboard, the maximum amount of weight the boat can safely carry, and the maximum horsepower your boat was designed to handle.

Note: Do Not Overload your boat.

Before Starting the Engine



- Determine if the trip can be safely made by checking the weather.
- Are all the proper boat and personal documents on board?
- Check operational equipment, such as running lights and horns to make sure they are on board, and operable.
- Make sure there are enough provisions for the cruise.
- Leave a float plan with someone who can notify authorities in the event you do not return in the allotted time.
- Double check the fuel and engine oil levels.
- Check the emergency stop lanyard to see if it is properly attached, and that the shift lever is in the neutral position.
- Check fuel and oil to make sure you have more than enough for the planned trip.

Remember the rule of thirds: 1/3 out, 1/3 back, and 1/3 in reserve.



After Starting the Engine

- Upon initial start-up, make sure to follow the manufacturer's recommendations for engine break-in
- Check to be sure there is a tell-tale water stream exiting the engine.
- Check the gauges to determine if everything is nominal.
- Check to make sure everything is secure and properly stowed away; remember the boat's movement is dynamic and anything loose will become a hazard at the worst possible time.
- Have a great time on the water



Remember that the captain is responsible for the safety of the crew and passengers and for his/her boat's wake damage.

Chapter 8 Safe Operation

Never operate the boat while under the influence of alcohol!

- Make sure someone else on-board knows how to operate the boat in the event you are injured and unable to operate the boat.



If you are operating the boat for the first time, make sure you follow the engine manufacturer's break-in recommendations. This will assure proper break-in and reduce the possibility of engine problems.



8.2 Basic Rules of the Road

The following is not intended to be a comprehensive course in seamanship and rules of the road, but instead an introduction. It is strongly recommended that a boating safety course be taken from your local Coast Guard Auxiliary or local Department of Natural Resources. There are also many good reference books in your local library as well as numerous sites on the internet.



Remember, paddle boats, sailboats and other vessels (such as barges) which are unable to maneuver, always have the right of way over powerboats. Sail boats, when under power, are considered motor boats. However, always boat defensively.

Aids to Navigation

Along the coast lines and in navigable inland waters, aids to navigation have been placed by the U.S. Coast Guard. These have been placed for the boating public's safety. Please become familiar with them and learn to use them to make your boating safer and more fun.

Federal Waterways Marking System Aids

Lateral Aids as seen from Seaward (port side green)



8.3 Safe Operation

Getting Underway

After clearing the dock, make sure the power trim (if so equipped) is trimmed down. (This will bring the boat up on plane more quickly and easily.) Give the engine sufficient throttle to bring it to plane briskly, then back down to the cruising speed of your choice, based on the sea conditions and your planned activity.

Chapter 8 Safe Operation

- After coming on plane, raise the trim to a point where the engine is level with or slightly above the plane of the water. This is usually with the bow at about 3° to 5° above level. This will provide the smoothest, most economical operation.

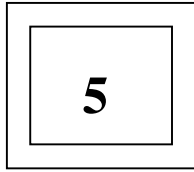

Daymark

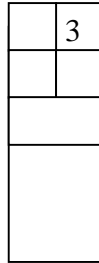

Can Buoy

Lateral Aids as seen from Seaward (starboard side)

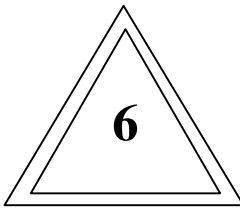

Daymark

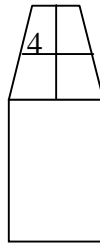

Nun Buoy

- Keep a constant vigil for other boats and watercraft and be prepared to give way, or slow down, if necessary. (We suggest you enroll in a boating safety course offered by the U.S. Power Squadron or the Coast Guard Auxiliary.)
- When coming off plane, allow the engine to come back to an idle speed until the boat slows down.
- Shift to the neutral position.

Never allow anyone to sit on the gunwale while the boat is moving!

While underway keep a constant vigil for other craft that may be approaching, the gauges on your boat, location of passengers and the general sound and feel of your craft. Often, a change in the way the engine sounds or the boat feels will presage a problem. Your early attention may prevent a more serious problem.

If you should strike an underwater object, bring the throttle to neutral and stop the engine. Inspect the lower unit for damage. If none is apparent, proceed as before but heighten your awareness of the engine and its operation to make sure a problem has not gone undetected.

Chapter 8 Safe Operation



8.4 Towing or Being Towed

Sooner or later you will have the misfortune of having to be towed in or needing to tow someone back to a safe landing. It is important that this be done properly so that a difficult situation does not become worse. This comes under a longstanding, unwritten law of the sea that one boater will aid another in time of distress. The 1971 Boating Safety Act grants protection to those assisting others at sea as "Good Samaritans" and absolves them of civil liability rising from the aid being provided.



When being towed, it is best to have a line passed from the tow boat to the one being towed, assuming the towing boat has a line of adequate size and length. The tow boat should also tow the disabled vessel from as close to amidships as possible. This reduces the tendency to yaw. If possible, the towing boat should use a bridle attached to the two stern ski tow eyes. The vessel being towed should attach the tow line to the bow eye that holds the boat onto the trailer. This provides an optimal tow position and a strong tow point. Have the occupants of the boat being towed sit aft of amidships, but not all in the stern. Attention should be given so the boat remains balanced and on an even keel. Some boats tow better with the engine tilted out of the water, others need the engine to act as a rudder to be able to maintain a straight line. Start with the engine tilted. If that does not work well lower the engine until it is about perpendicular.

You should never attempt to plane off the boat being towed.

8.5 Stopping the Boat

Gradually bring the controls back to the low forward position and allow the boat to gradually slow down. After the boat has dropped into the displacement mode, shift to the neutral position. If you have been running the boat hard for some time, allow the engine to idle for several minutes to gradually cool down. After docking and securing the boat, turn off the ignition.

8.6 Docking

Safe docking keeps your boat from being damaged and is an indicator of a capable and knowledgeable captain. There are many docking maneuvers, which will be done while boating; only the basics will be discussed here. Several constants to always use as guides while docking:



Perform docking at idle or no wake speeds. Always try to come into wind or current, whichever is stronger. This allows you to use the natural forces which affect on your boat to act as a natural brake. The skipper is free to use the boat's power to control speed and direction.

The approach to the dock should be at roughly a 45° angle, when possible. This approach angle allows the captain to bring the bow close to the dock, and then to use reverse, while turning the wheel toward the dock, to bring the boat to a safe, controlled stop.

Never approach a dock on plane. Even after reducing engine speed, the wake will push the boat uncontrollably into the dock.

8.7 After Operation

- Refill the fuel tank and engine oil, if yours is a two-cycle engine. A full fuel tank is less subject to condensation and therefore, less fuel problems. If you will be leaving the boat for an extended period, use a good fuel stabilizer. Each engine manufacturer makes their own and proper use will avoid many fuel related and lay-up problems. Remember, always follow the manufacturer's recommendation.
- If the boat is to be left in the water, make sure it is secure and free to properly accommodate any tide.

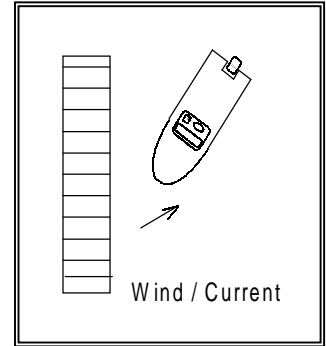

8.8 Trailering Your Boat

Note: If you have doubts or questions about your tow vehicle or towing, contact your dealer.

Before going on the highway, make sure your tow vehicle and trailer meet the local regulations for trailers and towing in your state.

Before leaving the driveway make sure the lights on the trailer are operating properly. If necessary, get a second person to make sure of the operation.

At least once a season, check and repair/replace the trailer wheel bearings.

The trailer should be adequately sized for your boat. Allow about 10% above the maximum boat weight for trailer capacity.

Make sure your vehicle is properly equipped to handle the load. This includes engine, hitch, frame, brakes, transmission cooler, and vehicle capacity.

Securely attached the boat trailer to the vehicle hitch, hook the safety chains and and cross them under the hitch and check the lights to ensure they are hooked up and working.

If you are new to trailering your boat, it is best to practice before actually getting in a situation where you are not sure of your ability. If possible use a trailer without a boat to practice with as you can see the trailer's movement without the boat. Also, your vision will not be impaired by the boat's presence.



When going forward, remember that your trailer turns inside the tow vehicle, therefore the tow vehicle must start the turn slightly later than without the trailer. This allow the trailer to turn inside the tow vehicle radius without leaving the roadway.

When backing, remember, the bottom of the steering wheel will move in the direction the trailer will ultimately go. Backing consists of two parts, breaking the trailer by turning the vehicle's backward motion in the opposite direction from the ultimate trailer direction, then following the trailer toward the correct direction with the tow vehicle. It is prudent to go to a large paved area with little traffic to practice these maneuvers before attempting them on the boat ramp.

Remember to check to see if the tow ball is the same size as the trailer coupler. Never use a different size.

Chapter 8 Safe Operation

8.9 Launching Your Boat

When you arrive at the ramp, prepare your boat before getting in the ramp line.

- Make sure the hull plug is in place.
- Place a line on the bow and stern cleats to be at the dock ready.
- Have fenders out and on the proper side.
- Raise the engine so it will not be damaged during launching.
- Remove any tie-down straps.
- If someone is with you, hand them the free end of the bow line and have them follow the trailer as you enter the ramp.
- Back the boat into the water until it barely floats. Remove the winch line. The boat should now come free with a gentle tug on the bow line.
- Lower the engine, pump the fuel bulb until firm and crank the engine.
- Let it idle for a few minutes to warm up before getting under way.

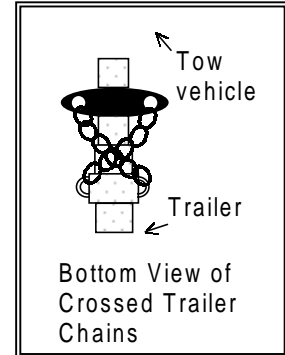

8.10 Retrieving Your Boat

There are several ways to retrieve your boat. The method described herein requires two persons.



- Drop someone off to back the trailer into the water, or do it yourself. If doing it yourself, make sure you make it easy and safe to exit the boat after it is loaded onto the trailer.
- Back the trailer into the water until the bunks are completely submerged, or until the middle roller is just touching the water. (This depth should provide enough to float the boat until the last minute and yet provide enough resistance from the trailer to stop the boat short of the winch stand.)
- Drive the boat onto the middle of the trailer. This is assuming it is a trailer designed for drive on. Speed should not be over one or two knots. Fast enough to maintain steerage but slow enough to be easily controlled.
- Once the boat has touched the trailer, a little forward throttle should secure the boat on the trailer and allow you to put the engine in neutral and have the winch line attached to the bow eye. The boat should now be easily winched onto the last several feet of the trailer.

When properly done, this method is easy, safe and will not harm boat ramps by powering away the soil from the base of the ramp.

9

Routine Maintenance

9.1 Exterior Hull and Deck

Fiberglass

When you remove the boat from the water, clean it as soon as possible. Dirt, debris and grime will come off easier while it is still wet. Use a brush and biodegradable boat cleanser. Stubborn areas may be cleaned with a non-abrasive cleaner. Harsh abrasives and chemical cleaners are not recommended as they can damage the gelcoat, shorten its life, and make it more susceptible to stains. When used in saltwater, the boat should be washed after each use.

The hull should be waxed periodically, at least once a year, with a high quality wax. This will keep it shiny looking and help prevent chalking and aging. The wax will also make it easier to keep clean by closing the pores that trap the grime.



If the boat is to be kept in freshwater or saltwater for an extended period, a proper barrier coat and bottom paint must be applied.

Do not wax non-skid areas. It could make them slippery and increase the possibility of injury.

Sump Area

Your EdgeWater utilizes a sump area containing a bilge pump and float switch assembly. This area can be maintained well by periodically using a boat bilge cleaner. Follow the directions carefully so as not to damage the bilge pump and float switch.

Stainless Steel Hardware

The stainless steel hardware of your boat should be cleaned and washed after each boat use, especially in salt or polluted water. While it is “stainless” it is not “stain-proof”. If it is not cleaned, it can develop surface rust stains. It can be protected with a high quality automotive or boat wax. It can also be protected with a commercial metal cleaner and protectant.

Anodized Aluminum



The aluminum can be maintained with a regular washing with soap and water. Otherwise it can develop a surface corrosion, which can penetrate the anodizing and attack the aluminum underneath. If badly scratched, it can be repaired with an aluminum or silver paint.

Chrome Hardware

Use a good metal polish and protect with wax. This should be done every couple of months or as soon as you notice any finish deterioration.

Upholstery

Soap and water should be periodically used to clean the vinyl. Vinyl protector products can make the seats slippery, which may not be desirable. When cleaning the vinyl, be gentle. Do not use cleaners that contain ammonia, acetone, strong solvents, or powdered abrasive cleaners. They can damage and shorten the vinyl's life.

9.2 Engine

If you have a new engine with a built-in flushing device, the engine may be flushed without cranking. If the engine does not have a built-in flush device one may be purchased to fit.

To flush the engine, after connecting a water hose to the proper connection, turn on the water. Put the engine control in the idle position and crank the engine. Only let it run a couple of minutes. The gear case is water-cooled and is not designed to run out of the water for extended periods.



Do not crank the engine without water running. Water acts as a coolant and also a lubricant for the water pump.



Do not rev the engine when flushing; idle speed is sufficient!

The exterior of the engine will respond well to a good quality wax. This should be re-applied every several months as the marine environment is a very harsh one and the constant sun exposure will deteriorate your motor's finish. Consult the engine manufacturer's owner's manual for specific instructions. In areas where there is a conflict between this manual and the engine manufacturer's manual, the engine owner's manual will take precedence.

10

Exterior Equipment

10.1 Anchor Locker

The anchor locker on your new EdgeWater 135ST has been designed as a combination anchor locker and storage locker. Your anchor line should have a shackle attached to the free end which should be attached to the cleat mounted on the foredeck.



Remember, your anchor line should be a minimum of 7 times the depth in which you routinely operate.



Your EdgeWater 135ST should have a minimum of 75 to 100 feet of 3/8" three strand nylon line. This may sound like a lot but remember that it takes 7 times the water depth to safely anchor in anything other than calm conditions.

11

Seasonal Maintenance

11.1 Engine

Refer to your engine manual for any specific information pertaining to your engine. For the fuel system, add a fuel stabilizer to a full fuel tank as per the stabilizer's instructions. Run the engine for a minimum of 10 minutes to allow the fuel stabilizer to reach the engine.

- Wax the engine exterior.
- Remove the engine cowl and spray the engines powerhead with a non-conductive lubricant spray. Do not spray directly on joints that are lubricated with grease as some lubricant sprays may dissolve grease.
- Grease all external zert fittings on the engine and steering system. Use a grease that is consistent with engine manufacturer's recommendations.
- Change the engine lower unit lubricant. This will remove contaminants that may have built up throughout the boating season. This is also a good time to check for lower unit seal problems. If there is a leak, have it repaired by your dealer.
- Remove the propeller and grease the propeller shaft. Inspect the shaft and propeller for unusual wear or signs of deterioration.

11.2 Hull

- Wax the entire boat. The hull will maintain its factory delivered luster much longer if waxed at least once a season. The inside of the boat, which is subject to the sun's direct rays, will also respond well to a good coat of marine wax.



DO NOT WAX the non-skid surfaces.

- Remove the hull plug so the sump area can breathe.

11.3 Trailer

- Check the wheel bearings for water. Clean and repack/replace as necessary.
- Check the tires for proper inflation.
- Try to store the boat and trailer with the bow slightly elevated so it will drain.
- If possible, cover the boat so that the sun will not deteriorate and tree sap and other environmental hazards will not damage the deck or upholstery. If covered, make sure to let air circulate so mildew will not build up. If in a high snow or rain area, make sure to properly support the cover to sustain and shed the load.

Appendix 135ST

Fuel System

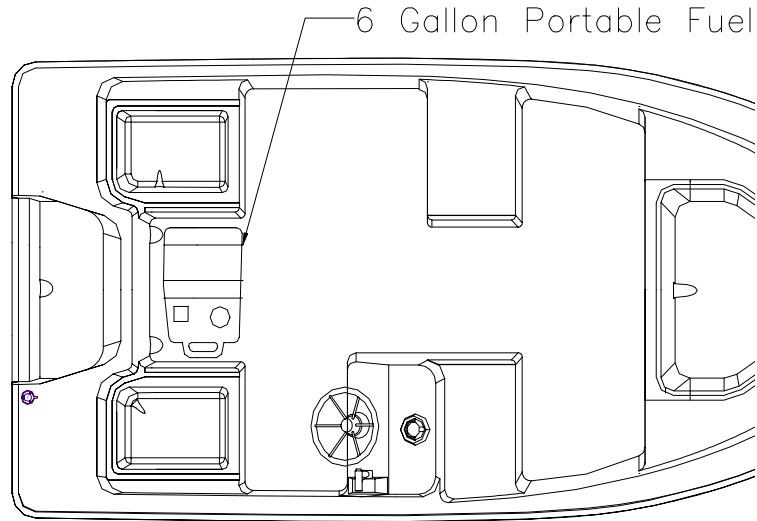

Drain System

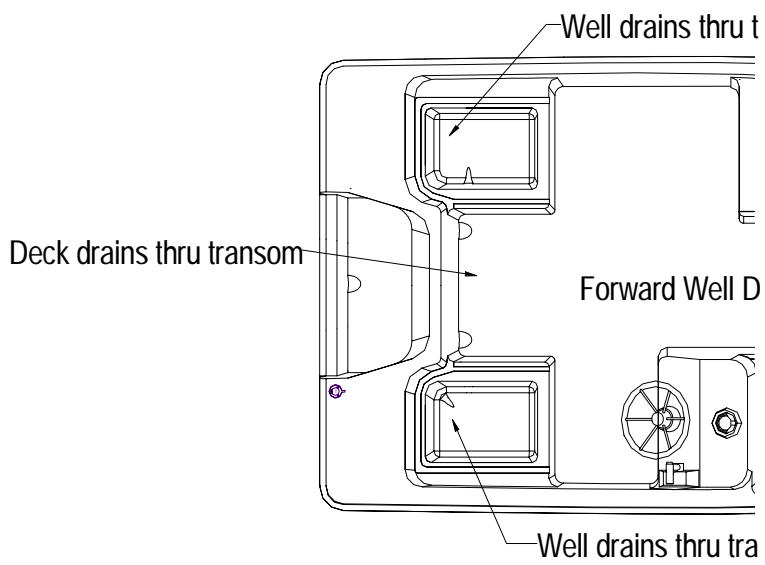

Electrical System

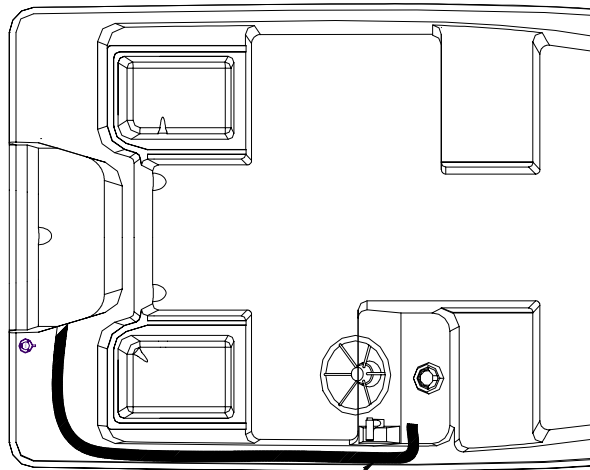

Rigging and Electrical Routing

135ST Switch Panel (rear view)

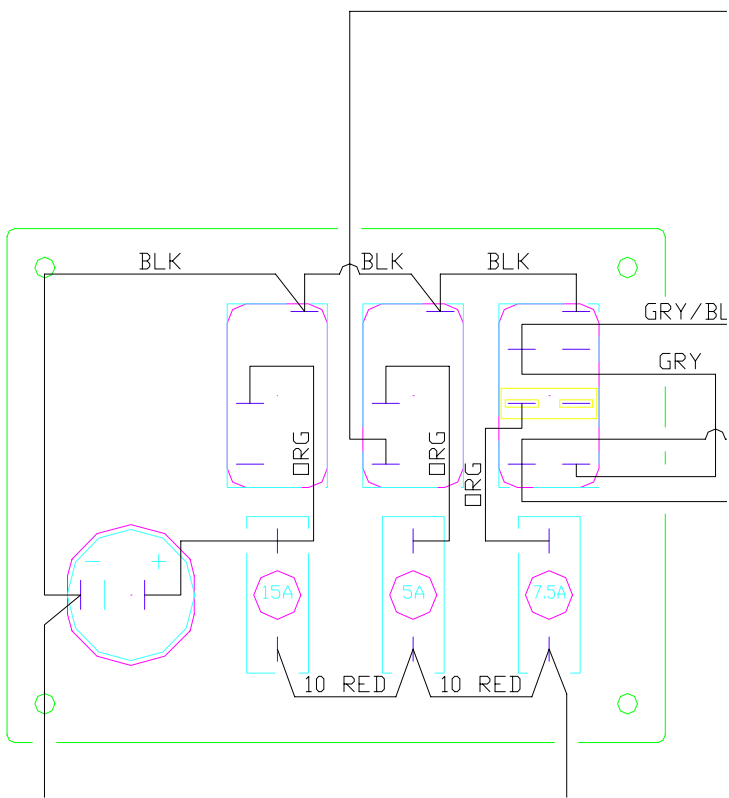

135ST Wiring Harness

