

# OWNER'S MANUAL

# 296 DC

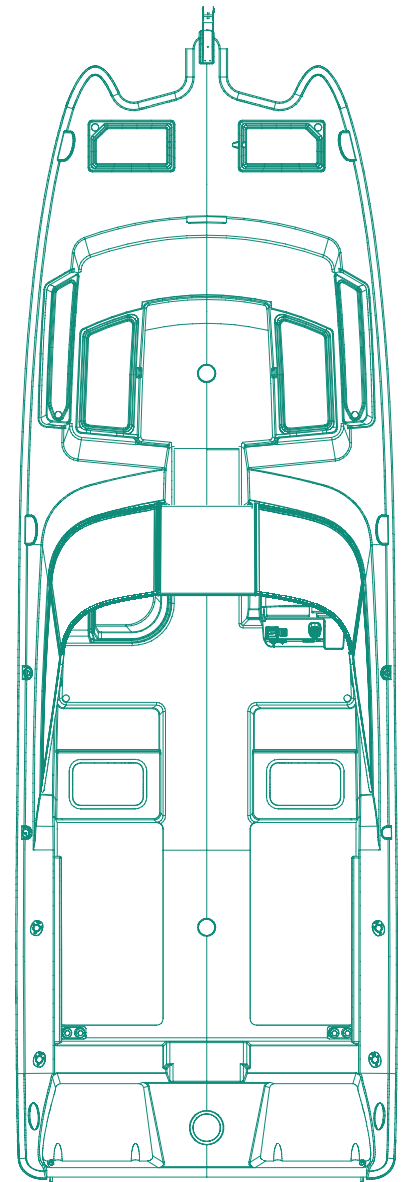

Dear World Cat Owner:

Thank you for being our customer. Welcome aboard!

We wish to take this opportunity to sincerely thank you for putting your trust in our boat building team and becoming the newest member of the World Cat Family.

The following manual is designed to ensure you enjoy your new World Cat for many years to come. We have made every effort to ensure you and your family are safe, enjoy the unique features of a World Cat, and continue to love the World Cat ride that no other boat company can offer.

If you should ever need assistance with the care, maintenance, or operation of your boat, then please visit our website at [WorldCat.com](http://WorldCat.com) to find contact information for your nearest Factory Authorized Dealer.

Once again, thank you for becoming a part of our family.

Best Regards,



ANDREW BROWN  
President

Best Regards,



ANNA BOSLER  
Customer Care Representative



1090 West Saint James St., Tarboro, North Carolina 27886

## TABLE OF CONTENTS

<b>Chapter 1: Customer Information .....</b>	<b>5</b>
1.1 Owner's Portfolio .....	5
1.2 Warranty Information .....	5
1.3 Dealer Responsibilities .....	5
1.4 Owner's Responsibilities .....	6
1.5 Manual Legend .....	6
<b>Chapter 2: Boat Information .....</b>	<b>7</b>
<b>Chapter 3: Boat Specifications .....</b>	<b>8</b>
3.1 296DC Standard Boat Specs.....	8
3.2 296DC Standard and Optional Features.....	9
<b>Chapter 4: Safety and Regulations .....</b>	<b>10</b>
4.1 Operator Responsibilities.....	10
4.2 Registration.....	10
4.3 Coast Guard Required Safety Equipment.....	10
4.4 Recommended Safety Equipment.....	11
4.4.1 Capacity Information .....	11
4.5 Pollution Regulations.....	11
4.6 Boating Safety Guidelines.....	12
4.6.1 Pre-Departure .....	12
4.6.2 Launching .....	12
4.6.3 Underway .....	12
4.6.4 Returning.....	13
4.7 Trailering.....	13
4.8 Anchoring.....	13
4.9 Shallow Water .....	13
4.10 Emergency Situations .....	14
4.10.1 Emergency Stop Switch.....	14
4.10.2 Communication.....	14
4.10.3 Rendering Assistance.....	14
4.10.4 Reporting Accidents.....	14
4.10.5 Weather .....	14
4.10.6 Towing.....	14
4.11 Carbon Monoxide (CO).....	15
<b>Chapter 5: Performance .....</b>	<b>16</b>
5.1 Overview .....	16
5.2 Motor Trim.....	16
5.2.1 Bow Up Condition.....	16
5.2.2 Bow Down Condition .....	16
5.3 Engine Controls.....	16
5.4 Steering Controls .....	17
5.5 Steering Maintenance.....	17
5.6 Power Steering.....	18
5.6.1 Power Steering System - Bleeding Instructions.....	18
5.7 Handling Characteristics .....	20
5.7.1 Turning Characteristics.....	20
5.7.2 Adverse Sea Conditions .....	20
5.7.3 Cross-Clutching.....	20
5.7.4 Get the Boat on Plane .....	20
5.7.5 Keep the Boat Level .....	20
5.7.6 Handling Different Sea Conditions.....	21
5.7.7 Boating Tips .....	21
5.8 Performance Factors.....	21
5.8.1 Engine Efficiency.....	21
5.8.2 Propeller Condition .....	21
5.8.3 Weather Conditions.....	22
5.8.4 Load .....	22

5.8.5	Marine Growth .....	22
5.8.6	Bottom Paint .....	22
<b>Chapter 6:</b>	<b>Systems Information .....</b>	<b>23</b>
6.1	Overview .....	23
6.2	Fueling Guidelines .....	23
6.2.1	Before Fueling .....	23
6.2.2	During Fueling .....	23
6.2.3	After Fueling .....	23
6.3	Fuel System .....	24
6.3.1	Fuel System Benefits .....	24
6.3.2	Fuel Tank .....	24
6.3.3	Fuel Vent .....	24
6.3.4	Fuel Distribution System .....	25
6.3.5	Filling Fuel Tanks .....	25
6.3.6	Pressure Relief Fuel System Diagram .....	26
6.3.7	Trouble Shooting Tips .....	26
6.3.8	Integrated Fuel Demand Valve Components .....	26
6.4	Ethanol-blended Fuel .....	27
6.4.1	Additives .....	27
6.5	Electrical System .....	27
6.5.1	Battery System .....	27
6.5.2	Battery Distribution .....	27
6.5.3	Emergency Parallel .....	28
6.5.4	Voltage Sensor Relay (VSR) .....	28
6.5.5	24 Hour Circuits .....	28
6.5.6	Anchor Windlass .....	28
6.6	Battery Selection .....	28
6.6.1	Battery Care .....	28
6.6.2	Safety .....	29
6.6.3	Exposure .....	29
6.7	Wiring and Circuit Protection .....	29
6.8	Control System .....	29
6.9	Dash Switch Panel .....	30
6.10	Accessories .....	30
6.10.1	Navigational Lights .....	30
6.10.2	Cockpit Lights .....	30
6.10.3	Cabin / Console Lights .....	30
6.10.4	Spreader Lights .....	31
6.10.5	Dome Light .....	31
6.10.6	Bilge Pump / Float Switch .....	31
6.10.7	Seacocks .....	31
6.10.8	Raw Water Pump .....	31
6.10.9	Freshwater Pump .....	32
6.10.10	Macerator Pump .....	32
6.10.11	Livewell and Livewell Pump .....	32
6.10.12	USB Outlets .....	32
6.10.13	Anchor Windlass .....	33
6.10.14	Windshield Wipers .....	33
6.10.15	Horn .....	33
6.10.16	Shower .....	33
6.10.17	Yamaha 300 HP 4-Strokes with Command Link .....	33
6.10.18	Fusion Marine Entertainment System .....	33
6.10.19	Fusion Marine Wired Remote .....	33
6.10.20	LED Underwater Light Package (Optional) .....	33
6.10.21	Additional Accessory Switches (ACCY) .....	33
6.10.22	Optimus Electronic Power Steering Package (Optional) .....	34
6.10.23	Optimus 360 with Electronic Steering, SeaStation, Joystick, and SeaWays Autopilot (Optional) .....	35
6.10.24	Marine Head .....	36

6.10.25	Plumbing System .....	37
6.10.26	ProMariner ProSport Battery Charger .....	37
6.10.27	Windshield .....	37
6.10.28	Outriggers (Optional) .....	37
6.10.29	SureShade Pull-Out Boat Shade (Optional) .....	37
<b>Chapter 7:</b>	<b>Maintenance and Service .....</b>	<b>38</b>
7.1	Overview .....	38
7.2	Gelcoat Maintenance .....	38
7.2.1	Cleaning .....	38
7.2.2	Waxing .....	38
7.2.3	Repair .....	39
7.3	Bottom Paint .....	39
7.4	Upholstery .....	40
7.5	Trim / Plexiglass / Polyethylene .....	40
7.6	Stainless Steel / Aluminum .....	40
7.7	Bilge Compartments .....	40
7.8	Cockpit Drains .....	40
7.9	Winterization .....	41
7.10	Maintenance Schedule .....	42
7.11	Maintenance Log .....	43
<b>Chapter 8:</b>	<b>Hurricane / Moored / Anchored Preparations .....</b>	<b>44</b>
<b>Chapter 9:</b>	<b>Model Year 2019 Warranty Policy .....</b>	<b>47</b>
<b>Chapter 10:</b>	<b>Lewmar Deck Switch and Winch Operation .....</b>	<b>50</b>
<b>Chapter 11:</b>	<b>296DC Diagrams .....</b>	<b>52</b>
11.1	Thru-Hull .....	52
11.2	Freshwater System Diagram .....	53
11.3	Livewell and Raw Water Diagram .....	54
11.4	Marine Head Diagram .....	55
11.5	Port Deck Wiring Diagram .....	56
11.6	Starboard Deck Wiring Diagram .....	57
11.7	Battery Management Panel .....	58
11.8	Switch Panel Fuses .....	59
11.9	Wire Code .....	60
<b>Chapter 12:</b>	<b>Spare Parts List for Non-Warranty Repairs .....</b>	<b>61</b>

## Chapter 1: Customer Information

### 1.1 Owner's Portfolio

To help you enjoy the many features, benefits, and accessories on your new World Cat, we have provided you with the following materials:

- World Cat Owner's Manual (model specific)
- Vendor Supplied Manuals for various accessories
- Delivery Checklist
- Warranty Information

We refer to this package as the Owner's Portfolio, and will reference it often throughout this text. The portfolio contains a wealth of information, including advice on safety, operation, performance, maintenance, and warranty. Reading and maintaining this information is extremely important, and could be the difference between a positive and negative experience on the water.

For your convenience, World Cat also provides the NMMA publication *Sportfish, Cruisers, Yachts Owner's Manual*. It will be referenced occasionally in your owner's manual, and provides supplemental information on safety and basic boating practices.

### 1.2 Warranty Information

Upon purchasing your new World Cat, your dealer is responsible for completing the warranty card and returning a copy to the factory. The dealer should provide you with a copy to keep in a secure place so it can be referenced quickly in the event of a warranty issue. Please read your written warranty.

### 1.3 Dealer Responsibilities

Our dealers are an extension of the factory and we expect them to provide you with great customer service to help prepare you for a positive ownership experience. Therefore, we set forth a list of responsibilities for our dealers as follows:

- Provide courteous service and explanation of the product prior to the sale.
- Provide sea trials for potential owners.
- Provide a detailed orientation of your boat's features and general operation upon delivery, including safety and performance.
- Complete and sign delivery checklist.
- Explain, complete, and submit all warranty information in a timely manner after the purchase.
- Provide the customer with the Owner's Portfolio and explain the information included therein.
- Provide service after the sale, or help the customer locate a qualified service shop at home or away.

### 1.4 Owner's Responsibilities

As an owner you should also take an active part in the delivery and safe operation of your new catamaran. Some of your responsibilities are:

- Study and understand the limited warranty information.
- Read all literature in your Owner's Portfolio and operate the vessel in accordance with those instructions.
- Review the Customer Delivery Inspection Sheet with your dealer prior to the final purchase and closing to ensure that the systems are functioning properly.
- Maintain the boat and perform service according to the instructions in this manual, including the 20 hour inspection for the vessel and engines.

It is your responsibility to return your boat to an Authorized World Cat Dealer for warranty work. In the event there is no World Cat dealer within a 100 mile radius of your boating location, it is your responsibility to present the boat to a marine professional in your area as directed and approved by World Cat.

Once your warranty information is processed, World Cat will maintain a record of your boat using the Hull Identification Number (HIN), which is located on the starboard side of the transom. Information regarding the dealership, owner, and the factory installed accessories will be recorded to help you should a problem arise. Also, you will receive a survey to rate your purchasing experience and the initial impressions of our company. We ask that you join our family of owners and let us know your feelings about the purchase and the quality of our product.

### 1.5 Manual Legend

Throughout this manual you will encounter signals to alert of important information. Text printed in bold letters and the warning system shown below is of particular importance. Please review this information prior to reading the manual.

#### **!!! DANGER**

This symbol alerts you to hazards or unsafe practices which will cause extensive property damage, severe personal injury or death if the warning is ignored.

#### **!!! WARNING**

This symbol alerts you to hazards or unsafe practices which can cause extensive property damage, severe personal injury or death if the warning is ignored.

#### **!!! CAUTION**

This symbol alerts you to hazards or unsafe practices which can cause personal injury or property damage if the warning is ignored.

#### **NOTICE**

This symbol is not hazard related. It contains information on installation, operation, or maintenance which is needed to ensure the proper operation of your boat.

## Chapter 2: Boat Information

Please fill out the following information and leave in this manual for reference. This information will be important for your Authorized Dealer to provide fast and accurate service. To locate an authorized dealer call 866-485-8899 or email [service@worldcat.com](mailto:service@worldcat.com).

<b>BOAT</b>	
Model:	HIN:
Purchase Date:	Delivery Date:
Ignition Key #:	Door Key #:
<b>ENGINES</b>	
Make:	Model:
Serial # Port:	Serial # Stbd:
Propeller Make / Model:	Propeller Diameter / Pitch:
<b>TRAILER</b>	
Make:	Model:
Serial # Port:	Serial # Stbd:
<b>DEALER</b>	
Name:	Salesman:
Dealer Phone:	Service Manager:



# 296DC

GO ANYWHERE, DO ANYTHING



LENGTH	BEAM	FUEL CAPACITY	DRY WEIGHT	DRAFT
29' 1"	9' 6"	233 gal	8,900 lbs	15"

## SPECS

- Length: 29' 1"
- Beam: 9' 6"
- Draft: 15"
- Freeboard Aft: 27"
- Transom Height: 25"
- Dry Weight w/ Power (approx): 8,900 lbs
- Max HP Rating: 600 HP (2 x 300 HP)
- Fuel Capacity: 233 gal (2 x 116.5 gal)
- Livewell Capacity: 25 gal
- Freshwater Capacity: 35 gal
- Wastewater Capacity: 15 gal
- Trailer Height\*: 10' 6"
- Bridge Clearance\*: 8' 10"
- Cockpit Length: 65"
- Typical Cruise: 30.3 mph / 1.7 mpg
- Typical WOT: 53.3 mph / 1.0 mpg
- Passenger Capacity: 12

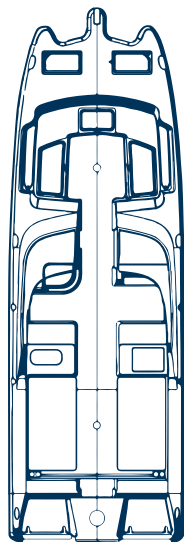

## HIGHLIGHTS

- Most spacious dual console in its class
- High-performing hull
- Swift and stable ride

\*Measured keel to top of fiberglass hardtop with no outriggers or electronics installed (not including trailer)

# 296DC

Experience the Ultimate Sea Trial™ - find your closest dealer at WorldCat.com

## FEATURES

### Bow

- Molded-in bow pulpit with roller and cleats
- Pro Series free-fall windlass with 300' line, 15' chain, 22 lb. anchor, and foot switches
- Bow seating with cushioned backs for 6 adults
- Port and starboard recessed handrails
- (4) stainless steel cup holders and storage compartment
- Lockable dry storage compartment with rod racks for (6) rods accessible from the head (port box)
- Forward insulated 225 qt. fish box with overboard drain (starboard box)
- Bi-fold weather door between the consoles
- (2) 500 gph forward bilge pumps

### Head

- Head / changing room with 23" wide access door and standing headroom
- Marine head with a 15 gal. holding tank and overboard discharge
- Head enclosure vanity, mirror, and Corian® countertop with stainless steel sink. Fiberglass door has handrail and provides access to lockable rod locker

### Helm

- Fiberglass top with surfboard edge and powdercoated frame, overhead lights, and spreader lights
- Safety glass walk-through windshield with walk-through door latch
- Starboard console storage area with removable floor lids for access to (3) batteries and waste tank. Area also provides access to electronics & storage for the optional bow table

- Helm and passenger dual custom seats with nearby recessed stainless steel cup holders
- Helm seat has flip-up bolster
- Ergonomic dash layout capable of (1) 12" screen
- Premium marine entertainment system with (4) JL Audio speakers, remote, and Bluetooth
- Integrated 3-bank battery charging system
- Power assisted hydraulic steering system
- 15" stainless steel wheel with power knob
- Magnetic catches on head entry and walk-through doors
- Starboard seatbox with 150 qt. insulated fishbox / cooler and raw water washdown
- Port seatbox houses 25 gal. insulated livewell with 1,100 gph magnetic drive pump, overboard drain, and a clear lid

### Stern

- Twin aft-facing seats on seatboxes with flip-down footrests for comfort
- Port and starboard sealed fuel-filter compartments for easy maintenance
- (6) pull-up stainless steel cleats
- (6) gunwale-mounted stainless steel rod holders
- Dual aft fold-down seats with backrest cushions
- Walk-through transom with heavy-duty door, bait prep, and tool storage
- Fresh water transom shower with 35 gal. water tank
- User-friendly On-Ramp™ swim ladder and swim platform



## OPTIONS

### Engine Packages

- Yamaha 300 HP 4-strokes with CL7 touchscreen display (Yamaha gray or Yamaha pearlescent white)

### Accessories

- Edson satin-finish steering wheel with power knob and nut
- Pantograph-style, heavy-duty windshield wiper with rinse
- Woven Sea Grass cockpit flooring with rubber backing and stainless steel snaps
- Removable bow / stern table
- (5) rod hardtop-mounted rocket launchers

### Electronics

- Single Garmin GPSMAP® 7612xsv 12" multi-touch widescreen Chartplotter / Sonar Combo, Airmar B175M transducer, dark-tinted acrylic dash, Garmin 110 VHF with 8' antenna
- LED underwater lights (blue)
- Stereo upgrade - JL Audio 800W Amp, (4) speakers upgraded to 6.5" JL Audio M-Series speakers, and (2) additional 8.8" M-Series speakers

### Steering Systems

- Optimus Electronic Steering System
- Optimus 360 System with electronic steering, joystick, SeaStation, & SeaWays auto-pilot

### Outriggers

- Taco Marine® 380 Grand Slam™ XL top-mount outriggers with 16' (carbon fiber) or 18' (standard) telescoping poles

### Top

- Matching hardtop underside to hull side color
- SureShade® manually retractable hardtop shade with Sunbrella® canvas (Cadet Gray)
- Taylor Made Products™ bow shade

### Hull / Hardtop Colors

- Full-hull or two-tone hull color
- Flag Blue, Tanglewood Tan, Platinum Gray, Ice Blue, Petrol Blue

### Bootstripping

- Single color top and bottom: Dark Red, White, Black, Dark Blue, or Stardust
- Multicolor: Stardust (top) and Black or White (bottom)



## Chapter 4: Safety and Regulations

### 4.1 Operator Responsibilities

Prior to enjoying your World Cat, it is important to read and understand all the information detailed in your Owner's Portfolio. Knowing how to operate and maintain the systems on your vessel can make your experiences safe and enjoyable, as well as increase the performance and longevity of your boat. Federal law and most state laws clearly indicate that it is the operator's responsibility to maintain their vessel, and to operate it in a manner which protects the safety of their passengers and others. Reference page 10 of the *Sportfish, Cruisers, Yachts Owner's Manual* for a detailed list of owner responsibilities.

This manual will provide you a basic understanding of boating practices; however, we recommend all owners review federal, state, and local regulations regarding safety and traffic prior to using your World Cat. The U.S. Coast Guard Auxiliary and U.S. Power Squadrons offer excellent educational opportunities on a local level and are open to anyone. If a chapter does not exist in your area, reference page 10 of the *Sportfish, Cruisers, Yachts Owner's Manual* or contact the following numbers for other educational opportunities:

Boating Education Hotline	1-800-336-BOAT (2628)
U.S. Coast Guard Boating Hotline	1-800-368-5647

### 4.2 Registration

Vessels are required by federal and state law to be registered in the state where they are primarily used. Registration numbers and validation stickers must be displayed per regulations, and a certificate of registration must be on board while the vessel is being operated. When traveling away from your home waters, contact authorities at your destination to determine if any additional registration is required. Some areas require permits or temporary registrations to operate in their waters. When completing registration forms you will be asked for the Hull Identification Number (HIN). On your World Cat, the HIN is located on the starboard side of the transom. This number is unique to your boat and will be important for registering your vessel, as well as communicating with your dealer and our service department. Including this information in any correspondence or conversations will help our support network serve you better.

### 4.3 Coast Guard Required Safety Equipment

Once you have reviewed safe boating guidelines and filed for registration, it is time to equip your vessel. The U.S. Coast Guard's (U.S.C.G.) list of required equipment is shown below. To review the guidelines for each item, reference pages 23 of the *Sportfish, Cruisers, Yachts Owner's Manual*.

- Audible Signaling Device (Bell, Horn, or Whistle)
- Fire Extinguisher
- Navigation / Anchor Lights
- Personal Flotation Devices (PFD's)
- Visual Signaling Devices

## NOTICE

Remember to check with state and local agencies to ensure that additional items are not required to operate your boat in their waterways.



#### 4.4 Recommended Safety Equipment

Although not required, there are several additional items which help to ensure safety, and provide convenience for you and your passengers. A list of these items can be found in the *Sportfish, Cruisers, Yachts Owner's Manual* on page 24. Perform an annual inventory to keep tools, spare parts, and safety equipment in good condition. Immediately replace any items that have been removed from the kit.

### !!! CAUTION

Use only marine grade replacement parts. Most automotive and residential parts are not suitable for use in the harsh marine environment. Using them could lead to premature product failure, property damage, or personal injury.

#### 4.4.1 Capacity Information

On all boats under 26' in length, the manufacturer is required to provide capacity information. If you own a model under 26' in length you will find a rectangular metal plate near the helm. This plate will provide information on horsepower ratings and total capacities which include person capacities, motors, and gear. As an owner you should be aware of the weight on board. Exceeding capacity can endanger your passengers and vessel, as well as void any warranty remaining on the boat should a failure occur. Remember that this is a guideline for normal operation, and does not release you from responsibility should an accident occur. You must use rational judgment when adverse conditions are expected, and reduce your loads to create a margin of safety.

This label means your World Cat is certified by the NMMA. With this tag, you are assured your fuel system, electrical system, lighting, ventilation, and steering are not only in compliance with the US Coast Guard regulations, but also meet the more stringent standards of the NMMA. The National Marine Manufacturer's Association is a national trade organization serving all elements of the recreational boating industry including manufacturers of boating equipment. With this tag, you can have confidence in the safety of your boat.



Pursuant to NMMA certification, all World Cats over 26' in length are "Yacht Certified" and carry the placard shown here. Person and gear capacities are not predetermined, they are left to the operator's discretion. Therefore, the amount of load allowed onboard should result from considering all safety precautions.



Horsepower ratings, however, are set by World Cat and *should not be exceeded*. The max horsepower rating for the 296DC is 600 HP. Exceeding the factory recommendation will result in loss of warranty coverage on your vessel.

#### 4.5 Pollution Regulations

The Refuse Act of 1899 prohibits throwing, discharging or depositing any refuse matter of any kind (including trash, garbage, oil and other liquid pollutants) into the waters of the United States. This information is provided in a pamphlet that is normally received when registering your boat. Use the information below as a guideline, but study the pamphlet and understand any local regulations regarding pollution control. As the operator, you are also liable for individuals on your vessel disposing of materials in an improper manner.



## 4.6 Boating Safety Guidelines

As an owner / operator you should be prepared to handle any situation which arises before departure, while underway, or upon return to dock. Careful planning will add safety and pleasure to your experience and give you the confidence to handle emergencies if they develop. Listed below are some general guidelines which you should follow before any trip:

### 4.6.1 Pre-Departure

- Establish a float plan and provide it to a person whom you trust. The plan should give the details of your trip, including where you are going and when you expect to return. If you deviate from the plan, notify that person as soon as possible.
- If you anticipate operating in a new area, understand the local rules and request charts or information on any hazards you may not be aware of.
- If you are towing the boat, inspect the trailer including tires, lights, brakes, winch, and overall mechanical appearance. For trailering information see page 4 of *Sportfish, Cruisers, Yachts Owner's Manual*.
- Verify that you have all necessary safety equipment. This should include all the USCG required equipment as well as spare parts or other items you decided to include.
- Check fuel levels and determine if you require additional fuel for your trip.
- Examine the weight of the gear on your vessel and make sure you are not overloaded. Distribute the weight evenly on your vessel to ensure predictable performance.

### 4.6.2 Launching

- Prepare your boat prior to backing down, (i.e. secure all loose items, install garboard drain), then launch your vessel and move away quickly.
- Move your vessel away from the dock and complete a full system check. Ensure that electronics, pumps, and safety equipment are in working order.
- Instruct a passenger on the operation of the boat, and the location and function of all safety equipment onboard. You should never be the only person capable of safely operating your vessel.

### 4.6.3 Underway (See Chapter 5 on Performance)

- Obey all "Rules of the Road" and any local regulations. Use the information located on page 25 of the *Sportfish, Cruisers, Yachts Owner's Manual* to understand right-of-way and the various navigational and hazard indicators you will see on the water.
- Never operate a boat under the influence of alcohol or drugs.
- Do not allow individuals under the age of 16 to operate the vessel. Maintain direct supervision of inexperienced operators.
- Ensure that all passengers are safely seated while underway, and are using the hand rails World Cat has provided to remain securely in their seats.
- Use your electronics and judgment to remain abreast of changing weather. Storms develop quickly and you should be prepared to protect your passengers and vessel. See page 22 of the *Sportfish, Cruisers, Yachts Owner's Manual* for more tips on weather.
- Maintain a safe speed and respect other boaters as well as those on land. Obey all "No Wake Zones" and be aware of smaller vessels. The wake you produce could endanger other crafts and their passengers.
- Know the limitations of your craft and your experience. Understand the boat's handling characteristics and do not attempt to operate the vessel in conditions that are unsafe or beyond your experience level.

#### 4.6.4 Returning

- Obey navigational markers and be aware of any tidal changes since departure.
- Collect and dispose of refuse properly to maintain our waters for future generations.
- Prepare your boat for loading before moving to the dock. Quickly pull your vessel from the water and move away from the ramp to complete the preparation for trailering.
- Verify that trailer systems are working properly and all items are secured before leaving.
- Wash the boat and perform general maintenance upon returning home. (See instructions in Chapter 5).

As stated above, these are only general guidelines for safe boating. We recommend using these and any other available resources to protect your passengers as well as your vessel. Checklists can be an important tool in accomplishing this; see the example on pages 44 & 45 of the *Sportfish, Cruisers, Yachts Owner's Manual*.

#### 4.7 Trailering

Due to the nature of the hull, catamarans require specialized trailers. Your dealer will be able to provide them, as well as information on safe trailering practices. Tow vehicles should be rated to handle the load and stresses which accompany trailering your boat. A properly matched trailer should carry 5-10% of the total vessel weight on the tongue. Routine inspections should be performed on the vehicle and trailer prior to each trip, and thorough checks scheduled on an annual basis.

#### 4.8 Anchoring

There are several types of anchors available, each designed to operate in specific bottom conditions. Your dealer can provide information on which styles are most effective in your area. See page 56 of the *Sportfish, Cruisers, Yachts Owner's Manual* for more information and tips concerning anchoring.

### !!! CAUTION

Never anchor your boat off the stern. The weight at the transom, combined with adverse sea conditions, could allow water to enter the boat over the transom wall.

#### 4.9 Shallow Water

Although your World Cat draws a small amount of water for its size, shallow water should be a concern of all boaters. To avoid this hazard, pay particular attention to navigational markers and know the area you are operating in. Be aware of tidal changes, including those that have occurred during your trip. Rocks, stumps, or other hazards are more prevalent in shallow water and can cause major damage to your hull bottom. Engines can also suffer damage if they are allowed to run in the sand or mud.

If you do become grounded, tilt the motors up to reduce the draft at the transom. Often this will solve the problem; however, it may be necessary to rock the boat from side to side to break the suction along the keel. If you are grounded on an incoming tide, allowing the water to rise can help. Being grounded on an outgoing tide is a larger issue and you need to act quickly to free your boat to avoid being driven further aground. Use the anchor to secure the boat and await the incoming tide, or use it to pull yourself free.

## 4.10 Emergency Situations

Unfortunately, even the safest boating practices cannot eliminate the potential of emergency situations developing. Therefore you should prepare yourself and your crew to handle any problems that may arise. Establish specific plans for fires, man overboard, collision, etc., and review them with your passengers prior to departing. Planning allows people to remain calm, and gives everyone the confidence to resolve the problem. Below is important information which all owners should be aware.

### 4.10.1 Emergency Stop Switch

Lanyard clips are provided on all World Cats and, when used properly, provide an emergency stop for the engines should the driver fall from the helm position, or need to perform an emergency shutdown to respond to or avoid an accident. The clip attaches the driver to the ignition panel using a cord. A pull on the cord will release the clip from the shut-off switch on the panel and shut down the engines. To restart the engines, turn ignition switch to the off position, return binnacle to neutral position, insert safety lanyard back into clip and then turn ignition switches back on. This should only be used to prevent or react to accidents, and the operator is solely responsible for the decision.



### 4.10.2 Communication

If you witness an emergency or become involved in one, you should request assistance via radio communication or visual signals. Review the information in Section 4 of the *Sportfish, Cruisers, Yachts Owner's Manual* for detailed information on how and when to request assistance.

### 4.10.3 Rendering Assistance

Owners are required by law to render assistance to other boaters involved in an emergency situation such as fire, collision, casualty, etc., as long as it does not endanger your vessel or its passengers.

### 4.10.4 Reporting Accidents

Federal regulations require that operators involved in an accident file a written account of the situation within 48 hours. Reports should be submitted to the State Boating Law Administrator. You can obtain forms through the USCG or local authorities (i.e. harbor patrol, sheriff or police offices). In the event that a casualty or disappearance occurs as the result of an accident, you must notify the authorities immediately by phone or radio and fill out a written statement.

### 4.10.5 Weather

Pay attention to weather patterns. If you find yourself in the path of a storm, seek shelter immediately. If you cannot reach a dock, seek refuge inside the boat while the storm advances. Never get in the water and stay clear of metal components on your boat. If lightning strikes, it would likely pass through metal objects seeking a ground.

### 4.10.6 Towing

Due to an accident or loss of power, it may become necessary to tow another vessel or have your boat towed. If you are providing assistance, never attempt to tow a boat larger than your own. Be certain to use proper lines (ropes) and rational judgment to prevent further damage. Tow lines are under heavy strain, therefore passengers should remain clear of the lines to protect themselves from injury. For more information on towing, reference page 39 of the *Sportfish, Cruisers, Yachts Owner's Manual*.

#### 4.11 Carbon Monoxide (CO)

### **!!! DANGER**

Carbon Monoxide (CO) is a colorless, odorless, and tasteless gas produced by the exhaust system of any combustible engine. CO can cause brain damage or death if inhaled over an extended period of time. To protect yourself and your passengers, never block the ventilation outlets in cabins, consoles, or other enclosed spaces.

One of the most important considerations when dealing with boating safety is carbon monoxide. Commonly referred to as CO, carbon monoxide is a colorless, odorless, and tasteless gas emitted from any engine exhaust. Including inboards and outboards. A CO particle is close in weight to the air we consume; therefore it does not rise or fall in the atmosphere, but accumulates in enclosed spaces. Boat owners with enclosed heads, cabins, or canvas enclosures should pay particular attention to CO. Be aware that fumes produced on your boat can affect other vessels and other boats can affect you. A primary concern is the use of generators when boats are moored adjacent to each other.

Carbon Monoxide is poisonous and potentially fatal if inhaled over an extended period of time. Symptoms of CO poisoning include:

- Dizziness
- Nausea / Vomiting
- Headache / Throbbing in the temples
- Fatigue
- Muscular twitching
- Inability to focus or think clearly

If you or any of passengers experience any of these symptoms, leave the area and find a source of fresh air immediately. If your symptoms persist, seek medical attention.



## Chapter 5: Performance

### 5.1 Overview

This chapter will provide information on the performance characteristics of your catamaran; this is not a substitute for seamanship training or hands-on experience. First time boat owners should use the resources detailed in Chapter 1 to learn proper methods of boat operation. Experienced boaters who have never owned a catamaran should study this chapter completely. Do not assume that previous boating experience will apply to all situations, as there are several subtle differences in the handling characteristics of twin-hulled boats. For existing catamaran owners, this chapter should be a reference.

### 5.2 Motor Trim

The smooth riding characteristics of a catamaran are a result of the twin hull design. Their ability to slice through on-coming waves is far superior to the slamming characteristics seen on conventional vessels. Motor trim plays an integral part in how your catamaran accomplishes this. In a level or bow down attitude, your boat will slice through larger chop, but you may experience sluggish performance, a wetter ride and increased bow steering in a following sea. In a bow up attitude the boat will perform better, but may ride less smoothly. Experiment with the trim settings in various sea conditions to determine what you are most comfortable with. When using the trim to correct a listing condition, imagine an "X" connecting the starboard engine to the port bow, and port engine to the starboard bow (see drawing below).

#### 5.2.1 Bow Up Condition

To correct a bow up condition on the port sponson, adjust the motor trim "down" on the starboard engine. This will help the starboard sponson to rise and level the vessel. If moving to the lowest trim setting on the starboard engine does not correct the list, trim the port engine "up" to assist the change. Reverse the instructions to accommodate for a bow up condition on the starboard sponson.

#### 5.2.2 Bow Down Condition

To correct a bow down condition on the port sponson, adjust the motor trim "up" on the starboard engine. This will help the starboard sponson to fall and level the vessel. If cavitation occurs on the starboard engine, lower it to correct the problem, then trim the port engine "down" to assist the change. Reverse the instructions to accommodate for a bow down condition on the starboard sponson.

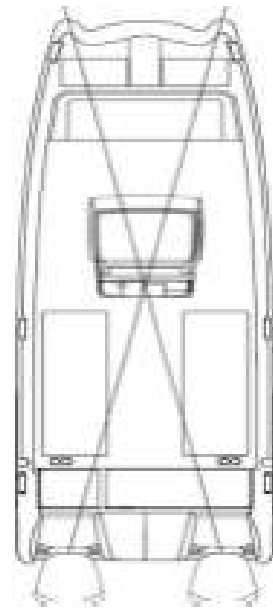

### 5.3 Engine Controls

All factory rigged boats will come equipped with a binnacle control specific to your type of engine. Located at the helm, the binnacle controls the throttle, shift, and trim mechanisms for your engine. For diagrams and general information about this system, review pages 80 - 83 of the *Sportfish, Cruisers, Yachts Owner's Manual*. Also read the owner's manual provided by your engine manufacturer to determine how to operate the features on your binnacle. If any components of this system need to be replaced, be certain to use the same style and length as the original equipment.



## 5.4 Steering Controls

Catamarans offer unsurpassed steering control. The wide spacing of the engines, advanced steering components, and handling characteristics of the World Cat hull give operators exceptional maneuverability in even the tightest spaces.

Because of the superior tracking abilities of the World Cat hull, oversteering can present a problem, especially for owners accustomed to operating conventional boats. Conventional vessels have a tendency to lose tracking abilities in rough and following sea conditions, making constant course corrections necessary. However, catamarans do not exhibit those traits and require operators to take a “hands off” approach. To do so, relax your grip and fight the urge to make constant corrections.

## 5.5 Steering Maintenance - Twin Engines

In order to maintain the excellent steering characteristics of your boat, occasionally you will need to visually inspect all hoses and fittings for leaks and fluid levels. We also recommend checking your steering cylinders to ensure all bolts and nuts are still tight.

In order to maintain the excellent steering characteristics of your boat, occasionally you will need to adjust the steering system to realign the motors (known as motor toe). To do so follow these instructions:

- Using the helm, center the starboard motor.
- Find the steering system valve, located under the inspection port on the center of the transom.
- Open the valve by rotating it 90 degrees (the handle will be parallel to the valve body when open). This will isolate the port engine, so that it can be adjusted manually.
- Center the port motor manually; then close the steering system ball valve and reinstall the inspection port.

Similar to hydraulic braking systems in an automobile, it may become necessary to bleed the steering system occasionally to remove air from the lines. We have provided a diagram of the steering system in this chapter, and the Teleflex™ owner's manual in your Owner's Portfolio. Use these resources, and your dealer, to keep the steering system in excellent working order. Be aware, these are routine maintenance procedures and are not covered under warranty by World Cat.

### **!!! CAUTION**

Routinely check hydraulic fluid levels and all connections for leaks or any sign of mechanical failure. Lubricate all mechanical parts at least annually with high quality marine grease. Failure to do so may result in impaired or unresponsive steering.

## 5.6 Power Steering System Diagram

The power assist unit provides automobile like steering on your catamaran. The unit is installed in the console between the helm and steering rams. The power for the unit is connected to the port and starboard key switch. If you choose to troll with only one engine your power assist will still be operational.

### NOTICE

If possible, have your dealer or trained marine technician perform routine maintenance or repairs on your steering system. Replace faulty parts immediately.

#### 5.6.1 Power Steering System - Bleeding Instructions

Reference the bleeding instructions provided by the SeaStar Solutions® owner's manual, which is included in your Owner's Portfolio. Use them in conjunction with the instructions and diagram below to bleed the steering system. This should be done annually or when air is detected in the system.

##### Step 1

- With the Power Purge turned "OFF", attach helm fitting and leads.
- Attach one of the leads to the bleeder valve on the Power Assist Pump.
- Open the bleeder valve using a 5/8" wrench.
- Turn the Power Purge unit "ON".
- Watch for air bubbles in the clear hydraulic lines. Once no more bubbles can be seen and there is a steady flow of hydraulic fluid through the lines, allow the Power Purge to run for an additional 60 seconds.
- The helm is now full of fluid. Turn Power Purge "OFF". Close bleeder valve and disconnect line from the Power Assist Pump. Place dust cap back on bleeder valve.



##### Step 2

- Attach the four lines to each of the bleeder valves on the steering cylinders.
- Open each of the four bleeder valves.
- Turn Power Purge "ON".
- Turn the steering wheel slowly 20 times clockwise, then slowly 20 times counter-clockwise.

##### Step 3

- With Power Purge turned "ON", move both engines through their full range of motion (This will help remove any air bubbles still trapped inside the cylinders).
- As a final precautionary step, pull on the engines firmly at the ends of their normal range of motion (This will also help to insure all of the air is out of the cylinders).

##### Step 4

- Turn the ignition key for the port engine "ON". This will turn the Power Assist Pump "ON".
- Repeat "Step 2".
- If no more bubbles can be seen then the bleeding is complete. Turn the Power Purge "OFF". Close all four bleeder valves. Disconnect the four lines from the cylinders and both lines from the helm. Remove the helm fitting and replace it with vent cap.
- If bubbles are still present in lines, then bleeding was not successful. Repeat entire process.

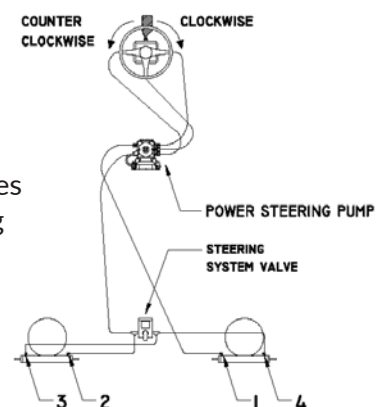

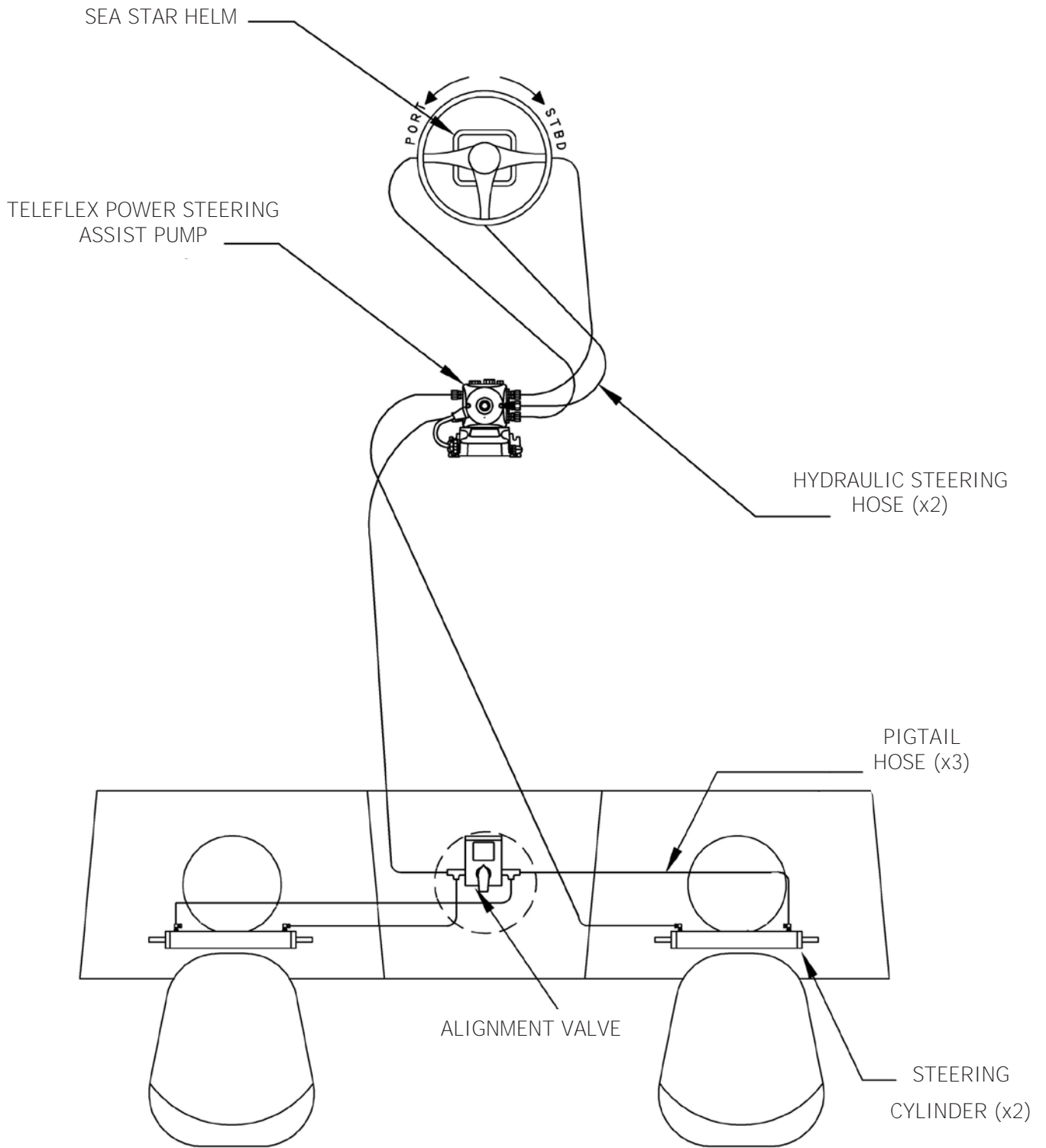

## 5.7 Handling Characteristics

World Cat's patented VectroFlo™ hull is a semi-displacement hull, which exhibits characteristics of both planing and displacement hulls. Planing hulls provide speed and economy of operation since a limited amount of the hull is in contact with the water. However, they feature flat sections along the chine which can negatively affect handling at low speeds and harder impacts at high speed. Displacement hulls provide superior handling characteristics, even at low speed, and an improved ride in rough water. Speed and economy suffer however, since more of the hull is submerged. Our proven design provides a superior ride, excellent handling characteristics in a variety of conditions, and speed with economy of operation. To help you experience "The Ultimate Ride", study the following sections:

### 5.7.1 Turning Characteristics

Turning a catamaran is slightly different than cornering on a conventional vessel. Imagine the difference between an automobile and a motorcycle: Automobiles take turns in a flatter, more stable manner similar to a catamaran hull, while motorcycles pitch hard into a turn similar to a monohull. Do not underestimate a catamaran's cornering ability. Hard adjustments to the steering wheel can make a World Cat bite quickly and execute high-performance turns. Experiment with the handling ability of your cat so you are prepared for any situation on the water.

### 5.7.2 Adverse Sea Conditions

Catamarans are designed to handle some of the roughest waters in the world, but that is no substitute for common sense. As an operator, you are responsible for the safety of your passengers and vessel; therefore, your trips should be limited by your level of experience. Planning and paying constant attention to the weather and sea conditions is paramount. If you are forced to operate in dangerous seas you can be confident that your World Cat, when operated properly, can handle them safely.

Here are a few tips on how to handle your boat in adverse sea conditions:

- When traveling into the wind, changing your direction a few degrees to allow one sponson to settle before the other, can make the ride smoother and allow for increased speed.
- In a rough chop with short wave intervals, increasing your speed may allow the boat to skim across the tops of each wave. This will result in a smoother ride.
- Steer to avoid larger swells and breaking waves.
- In a following sea, position your vessel on the back of a wave and match its speed to remain ahead of the trough. Speed is paramount. Work the throttle to avoid going over the wave or being thrown down the face of a following wave.

### 5.7.3 Cross-Clutching - Twin Engines

World Cat 296DC twin engines are mounted at a specific distance, based on the configuration of the boat, allowing you to cross-clutch (one motor in forward while one in reverse).

To dock, reverse the boat into a slip: put the outside motor in reverse and turn to face aft. Keeping the wheel straight, steer with the inside motor putting it in forward and reverse to guide you into the slip. Keep it simple and slow.

### 5.7.4 Get the Boat on Plane

- Trim both engines down (the motors act as trim tabs forcing the bow down).
- Quickly increase speed to get the boat on plane then slow down to 3500 RPM's.
- Adjust trim up until the motors cavitate, then tap trim down.
- Feel / hear the motors and do not watch the trim gauges.
- A smooth ride is more important than having your engine RPM's synchronized.

### 5.7.5 Keep the Boat Level (if the seas change or people move on the boat)

Trim the **High-Side-High**. When one side of the bow is high compared to the horizon, simply trim the high-side motor up. (If it cavitates then trim the **low-side-low**). Different models have different sensitivity to trim (do not over-correct as this may cause the boat to pitch in flat calm water at high speeds)

### 5.7.6 Handling Different Sea Conditions

- **Head Sea:** trim motors down to keep the bow down.
- **Following Sea:** trim up to keep the bow out of the water.
- **Calm water:** trim engines up to run on the back of the hull.

### 5.7.7 Boating Tips

Experience is the best way to determine the handling characteristics of your catamaran. Operating the boat in multiple sea conditions and under various loads will help you predict how the boat will perform in any situation. World Cat provides the following recommendations regarding the performance of your catamaran:

- Establish an RPM chart which details the speed and fuel consumption at various RPM levels to achieve the most economical operation.
- Monitor fuel gauges to determine the amount of operating time remaining at a given reading.
- Determine minimum speed for effective steering in close quarters.
- Determine the turning radius required at various speeds.
- Determine the rates of acceleration and deceleration with various load conditions. Include the distance required to stop the boat at various speeds.

Use the information provided in section 6 of the *Sportfish, Cruisers, Yachts Owner's Manual* for more information on boat handling.

## 5.8 Performance Factors

Proper setup and maintenance of the systems on your boat is important to ensuring proper performance, but be aware they are not the only factors which affect it. Several things which contribute to the level of performance of your catamaran can change between or during trips.

### 5.8.1 Engine Efficiency

Without proper maintenance, your engine(s) will gradually lose power, resulting in a loss of speed. Use the recommendations in the engine's owners manual to schedule routine maintenance procedures and as a guide for the correct RPM range for your engines. Neglecting to do so may result in loss of performance and an increased risk of failure.

### 5.8.2 Propeller Condition

The size and condition of your propeller also plays a major role in the performance of your catamaran. A damaged propeller can result in lower speeds, sudden drops in RPM, increased fuel consumption, and severe vibration while running. Improperly sized propellers can cause damage to your engine as a result of exceeding the maximum or minimum RPM levels.

### **5.8.3 Weather Conditions**

Barometric pressure and humidity can affect the output of your engines. For example, on an extremely hot and humid day, your engine can experience as much as a 10 percent loss in horsepower. Although you should monitor your engines' performance, be aware that the weather could be a major factor in your boat's performance.

### **5.8.4 Load**

Increased load can affect performance, especially if the load is unbalanced. Passengers, gear, and fuel are all examples of things which can affect your vessel. Fuel levels change throughout the day, and greatly affect the attitude of your boat. When necessary, make adjustments to engine trim and load distribution to compensate for fuel usage.

### **5.8.5 Marine Growth**

If you store your boat in the water or fail to clean it after each trip, the existence of marine growth can contribute to a loss of performance. A decline in speed or increased fuel consumption can occur. Prevent this by applying a marine growth inhibitor or by cleaning your boat thoroughly after each trip.

### **5.8.6 Bottom Paint**

Bottom painting your catamaran will also change the performance. Although not significant, you can expect a drop in speed between 1 and 5 miles per hour.

## Chapter 6: Systems Information

### 6.1 Overview

This chapter will provide you with basic information for all the systems on your boat. Understanding this information is imperative, as it directly contributes to the safety and enjoyment of your trips on the water. Talk with your dealer if you need further information on any of these systems.

### 6.2 Fueling Guidelines

Study the following guidelines thoroughly, and consult your dealer if you have questions. Be sure to read the engine manufacturers recommendations regarding the type and grade of fuel to use for your engines.

#### !!! WARNING

Avoid methanol or other alcohol based fuels or additives which can deteriorate fuel hoses. Alcohol-based fuels also absorb water which can lead to engine damage.

#### !!! DANGER

Follow all safety guidelines while fueling. Leaking or spilled fuel is an explosion hazard. Regular checks of the fuel system are needed to protect you and the vessel.

#### !!! DANGER

Static electricity can ignite gasoline vapors causing serious injury, death and /or destruction of property.

#### 6.2.1 Before Fueling

- Shut down the engines and turn off all electrical devices including the batteries.
- Close all hatches, port lights, and doors to prevent accumulation of fuel vapors.
- Extinguish cigarettes or other lighted materials.
- Keep a properly charged and correctly rated fire extinguisher nearby.

#### 6.2.2 During Fueling

- Use common sense and obey all safety regulations related to fuel handling.
- Avoid static sparks by maintaining contact between the fuel nozzle and fuel fill.

#### 6.2.3 After Fueling

- Secure the fuel cap and inspect for leaks.
- Clean up any spilled fuel and dispose of the cleaning material accordingly. Do not store fuel-soaked material on your boat.
- Open all hatches, port lights, and doors to allow for ventilation.
- Check for fuel vapors using a "sniff test" and do not turn on electrical devices, including batteries, until you are certain the fumes have dissipated.



## 6.3 Fuel System

Due to the nature of the hull design, your World Cat 296DC is equipped with separate port and starboard fuel systems. These systems act independently, providing fuel to the engine on their respective side. Tanks are constructed of polyethylene material to prevent corrosion.

Hoses are NMMA certified, and fittings are clamped securely to reduce the potential for leaks. However, comprehensive checks of hoses and fittings should be completed at least annually, including those normally hidden from view. Tighten all connections, replace deteriorated hoses, clamps or fittings, and, if necessary, replace the fuel / water separators during this check. World Cat has provided inspection plates (in the cockpit floor) to assist you with annual maintenance.

If you experience fuel flow problems, remove the fuel feed hose from your engine and connect it to a portable fuel tank. Doing so will help you determine if your fuel system or the engine is the source of the problem. Fuel system repairs and engine maintenance should be performed by a qualified marine technician.

The fuel / water separators are installed between the tank pickup and the engine. They are located in the aft rigging space. Inspect these filters regularly and replace when needed.

### 6.3.1 Fuel System Benefits

- Automotive-style refueling.
- Automotive Nozzle shut-off for overfill protection – reducing the possibility of accidental fuel spills.
- Fuel nozzle retention.
- Reduces hydrocarbon emission through the use of specially designed fuel fill. The fuel fill has a permanently attached cap incorporating a positive closure mechanism with an audible click, to let you know when the cap is sealed.

### 6.3.2 Fuel Tank

Your boat is equipped with two low permeation crosslink polyethylene fuel tanks each with a net fuel capacity of 116.5 gallons. The usable capacity of each fuel tank is different from the tank capacity marked on the tank from the manufacturer. The difference is the accommodation for the unfillable area that has been incorporated into your tank. It is recommended that you follow all of the instructions regarding the filling of fuel tanks.

### 6.3.3 Fuel Vent

The fuel tank vent is integrated into the fuel fill deck fitting (See fig. 6.3.6) The vent serves as an over pressure / vacuum release with anti-surge and flame / spark arresting protection. The fuel vent system also plays an important role in controlling the "FULL" level of fuel with the use of FLVV (Fill Limit Vent Valve). Grade Valves have been added to the tank which allows proper ventilation of the tank when the boat is stored, or trailered, on a moderate incline, without fuel. Always inspect to insure that the fuel fill deck fitting is free of debris and in proper working condition.

### 6.3.4 Fuel Distribution System

The fuel is delivered from the tank to the engine through the “Integrated Fuel Demand Valve” (IFDV), anti-siphon valve, and the fuel line. The IFDV prevents built up pressure inside the tank from being transferred to the engine, while still allowing fuel to flow to the engine for operation. The anti-siphon valve is a safety feature designed to prevent the fuel from siphoning out of the tank if the fuel line were to be cut or broken below the level of the fuel in the tank. Some fuel would still leak from the line, but the valve will not allow the entire contents of the tank to siphon into the boat.

#### What does the IFDV do?

The integrated fuel demand valve, used in conjunction with integrated fuel systems, is for below-deck use, eliminates pressurized fuel from reaching fuel distribution lines / the engine, and ensures that fuel is provided to the engine on demand rather than as a result of pressure in the tank. Additional features include:

- Compatible with Ethanol-blended fuels
- Eliminates the need for rigid fuel distribution lines in pressure relief systems (per ABYC H-24, 15.9)
- 2-year warranty

### 6.3.5 Filling Fuel Tanks

The fuel system is designed to automatically shut off the fuel nozzle when the tank is full via the “Inlet Control Valve”, (See Fig 6.3.6) similar to an automotive fuel system. The tank is filled when the fuel fill nozzle has shut itself off the second time. Attempting to fill the tank past this point may cause some of the components to not function properly, or malfunction.

#### **!!! WARNING**

The use of a portable fuel tank to fill your fuel tanks can result in overfilling and circumvent the safe features designed into our fuel tank system.

#### **!!! WARNING**

Modification of any of the fuel system components or the replacement of these components with unauthorized parts may result in over-pressurization of the fuel system and circumvent the safety features designed into your fuel system.

### 6.3.6 Pressure Relief Fuel System Diagram



### 6.3.7 Troubleshooting Tips

Possible Failures
<p>Loss of prime on the engine and / or fuel starvation:</p> <ul style="list-style-type: none"> <li>• Engine stalls out</li> <li>• Engine runs lean</li> <li>• Engine does not draw fuel properly</li> </ul> <p>Find possible leakage points and take corrective action:</p> <ul style="list-style-type: none"> <li>• Fuel line leak from tank to engine—replace components as needed</li> <li>• IFDV O-Ring—replace O-Ring</li> <li>• Pick-up Tube O-Ring—replace O-Ring</li> <li>• IFDV—replace IFDV</li> </ul>

### 6.3.8 Integrated Fuel Demand Valve Components

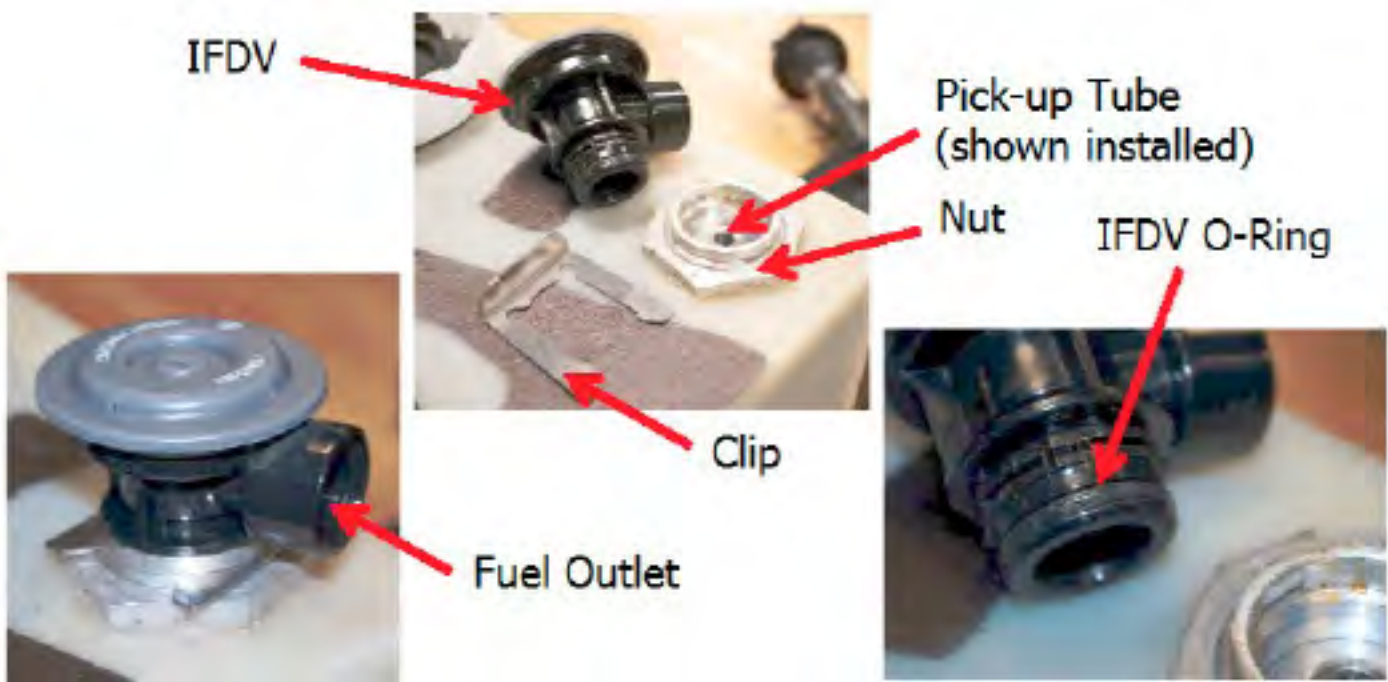

## 6.4 Ethanol-Blended Fuel

Ethanol is an oxygenated hydrocarbon compound that has a high octane rating, therefore it is useful in increasing the octane level of unleaded gasoline.

### NOTICE

The use of improper gasoline or additives can damage your fuel system and is considered mis-use of the system. Damage caused by improper gasoline or additives WILL NOT be covered under warranty.

### 6.4.1 Additives

World Cat exclusively powers every new boat with Yamaha Outboards. Under its *Maintenance Matters* program, Yamaha recommends the following additives be used to maintain your new outboard at top performance: **Yamalube Fuel Stabilizer & Conditioner** to protect against the damaging effects of today's ethanol fuels and **Yamalube Ring Free** to prevent carbon buildup.

See your Yamaha owner's manual and your authorized Yamaha dealer for more detailed maintenance instructions.

## 6.5 Electrical System

The electrical system on your catamaran consists of three major components: the battery system, wiring and circuit protection, and accessories. It is important that you understand the principles of the electrical system so that you can protect the components and troubleshoot any problems you experience.

### 6.5.1 Battery System

Your World Cat is equipped with three batteries. Two of the batteries are dedicated as "cranking batteries" while the third battery, commonly referred to as the "house bank," controls the DC accessories. To help maintain your batteries, a management system is installed on your boat. This system enables you to engage or disconnect the batteries, distribute electrical charge, and parallel batteries in the event of a failure.

### !!! DANGER

Disconnect the battery cables from the batteries prior to removing or working on the battery management panel. Failure to do so could result in electric shock. Reference the NMMA pamphlet in your Owner's Portfolio for more information.

### 6.5.2 Battery Distribution

This photo illustrates the battery management panel. The PORT START, STBD START, and HOUSE switches as well as the DC MAIN breaker are in the "OFF" position and the EMERG PARALLEL is "OFF". In the "ON" (turn clockwise) position, you are supplying power to the engines through the cranking leads and to the DC accessories through the 50 Amp DC MAIN breaker.

**NOTE:** Only turn the EMERG PARALLEL switch on when needed.

**Important:** When you have finished your trip, turn the PORT START, STBD START and HOUSE switches off prior to leaving the boat. The DC MAIN can remain "ON" at all times.



### 6.5.3 Emergency Parallel

In the event of a battery failure, the "EMERG PARALLEL" switch allows you to mechanically link the port "cranking" battery to the starboard engine or vice versa. The switch should remain in the "OFF" position when not in use. To prevent voltage spikes or drops which can damage electrical components, you cannot draw power from the house battery using the "EMERG PARALLEL" switch.

## !!! DANGER

All batteries contain an electrolyte, commonly sulfuric acid, which is a caustic and volatile chemical. Use extreme caution when charging or servicing.

### 6.5.4 Voltage Sensor Relay (VSR)

The twin voltage relay sensors are integrated into the battery switch cluster. They distribute the charging output from the engine alternator to the "cranking" and "house" batteries. After starting an engine, the alternator sends electricity back to the "cranking" battery to recharge it. Once the "cranking battery" is fully charged (13.6 volts), the VSR closes to allow the alternator output to charge the "house" battery. When the VSR is operating, the LED indicator located on the management panel will be lit. It will remain lit until the battery is fully charged, or the "cranking" battery voltage falls below 12.8 volts. It is common for the VSR to cycle "ON" and "OFF" during operation. However, constant cycling could indicate a problem in the system and should be checked by your dealer.

### 6.5.5 24 Hour Circuits

The fuse holders located at the batteries protect the 24 hour essential circuit wiring. Per NMMA and USCG guidelines, these fuses are constantly energized to provide power for bilge pumps and memory functions. This helps to protect your vessel even when you are not available. The battery switch does not need to be "ON" for these fuses to have power. Inspect the fuses regularly. If a fuse blows constantly, have your dealer investigate the problem as soon as possible to prevent damage to your boat.

### 6.5.6 Anchor Windlass

A 50 Amp breaker is installed at the factory for the anchor windlass. For Windlass Deck Switch Maintenance refer to Chapter 10 for details provided by Lewmar.

## 6.6 Battery Selection

World Cat supplies the original batteries onboard your vessel. We use both Group 27 and Group 31 batteries. In the event of a failure, replacements must be of equal size and specifications (see below):

### GROUP 27 (27MG)

CCA: 840

MCA: 1050

RESERVE CAPACITY: 182 Min @ 20A

### GROUP 31 (GDP31DT)

CCA: 700

MCA: 875

RESERVE CAPACITY: 182 Min @ 25A

### 6.6.1 Battery Care

Batteries should be secured in a non-metallic tray and insulated boots should cover the terminals. Depending on the style of battery you choose, inspect the electrolyte and perform routine maintenance as suggested by the manufacturer. Remove corrosion from the terminals quickly to prevent failure. Use a stiff brush and a solution of water and baking soda to remove corrosion, then grease the terminals to prevent further build-up. Be careful to clean up thoroughly to avoid contaminating the electrolyte.

When servicing the batteries, follow the safety procedures shown below and work to avoid electrolyte spills which can harm you and your vessel.

## !!! DANGER

All batteries contain an electrolyte, commonly sulfuric acid, which is a caustic and volatile chemical. Use extreme caution when charging or servicing.

### 6.6.2 Safety

- Use protective clothing and accessories such as aprons, gloves, and eye wear to protect yourself while servicing batteries.
- Avoid cigarettes, open flames, and sparks. Batteries can produce toxic and explosive gases; therefore, store or charge them in a well-ventilated space.
- Keep batteries out of the reach of children and pets.

### 6.6.3 Exposure

If you are exposed to the electrolyte solution, follow these procedures and seek immediate medical attention.

**EXTERNAL** - Flush with large amounts of water for contact with the skin. If severe irritation occurs or it contacts your eyes. Seek medical attention immediately.

**INTERNAL** - Consume large amounts of water or milk, coupled with milk of magnesia, a beaten egg, or vegetable oil. Seek medical attention immediately.

The guidelines above are basic and do not alleviate the owner of responsibility should an accident occur. Use good judgment and common sense to avoid an accident.

## !!! CAUTION

When reconnecting your batteries, always connect the red cable to the positive terminal and the black cable to the negative terminal (in that order). Reversing them can damage your electrical system and create the potential for electric shock.

## !!! CAUTION

Never disconnect a battery while underway. Doing so may result in damage to your boat's electrical system and the engine's alternator.

### 6.7 Wiring and Circuit Protection

Your World Cat is wired using marine grade tin coated copper wire instead of standard copper wire. Tin coated copper is manufactured to withstand the harsh saltwater environment better than standard copper, which is used for residential applications. Environmentally sealed Deutsch™ connectors are installed on all accessories located below the waterline to ensure watertight connections. The remaining devices are installed with high quality splices and terminals, which are heat shrunk to protect the integrity of the connection. Harnesses are routed through PVC rigging tubes to prevent chafing and covered with sheathing when necessary.

### 6.8 Control System

Your World Cat is equipped with a traditional switch operated DC control system. In the traditional setup, circuit protection is located in fuse blocks behind a door located behind the helm in the storage compartment. A label is mounted on each fuse panel to indicate which fuse controls a given appliance. If a fuse trips, replace the fuse with one of identical specifications. When possible, have your dealer replace defective electrical components. If that is impractical, be certain to use identical replacements to ensure the integrity of the system.



Accessories not integrated into the control unit can include lights with integrated switches, marine head controls, stereos, aftermarket electronics and 12V outlets. These devices draw current from the accessory fuse blocks. The fuse blocks are similar to those found in automobiles, and use blade style fuses to protect a circuit. You can obtain replacements for these fuses from your dealer or local auto parts store. Always replace a damaged fuse with one of equal rating.

### !!! CAUTION

When working on your electrical system, disconnect the batteries to prevent shock, or damage to your electrical system. If possible, have an electrician perform repairs.

### !!! CAUTION

Failing to use the correct replacement breaker could result in failure of the device or damage to the electrical system. Contact your dealer for repair information.

Ground blocks are another integral part of your electrical system. These are connected to the common battery ground and individual appliances to provide a path for current flow back to batteries.

For customers unfamiliar with electrical systems, World Cat recommends the following book:

**Boating Magazine's: Powerboater's Guide to Electrical Systems**

**Written by:** Ed Sherman

**Publisher:** International Marine (Division of McGraw Hill Companies)

**Copyright:** 2007 International Marine

## 6.9 Dash Switch Panel

The dash switch panel is a row of switches located across the upper dash panel. It controls the lights, pumps, and other accessories on your 296DC.



## 6.10 Accessories

Electrical accessories include all lights, pumps, and gauges assembled into your World Cat. Certain accessories are standard to each model, while others are optional equipment. Below is a list of accessories and their function.

### 6.10.1 Navigational Lights

Per USCG guidelines, all powered vessels must have navigational and anchor lights. Your World Cat is equipped with navigational lights at the bow or a pole light near the stern. These lights must be used in accordance with USCG regulations when anchored or underway.

### 6.10.2 Cockpit Lights

Cockpit lights are located at floor level to provide light while operating in low light conditions.

### 6.10.3 Cabin / Console Lights

Lights located in the cabin or in consoles have an integrated power switch and are tied directly into the fuse block. Operate them with the switch located at the base of the light.

#### 6.10.4 Spreader Lights

Attached to the hardtop or hardtop frame, spreader lights illuminate the cockpit in low light situations. They are operated using the switch on the dome light or instrument panel and are protected by a fuse block.

#### 6.10.5 Dome Light

Located under the hardtop radio box, this light features both white and red lamps for nighttime operation. It is powered by the fuse block located in the radio box.

#### 6.10.6 Bilge Pump / Float Switch

Your 296DC is equipped with two 1500 GPH bilge pumps and two 500 GPH bilge pumps. Each pump is connected to a float switch which automatically triggers the pump when water comes to rest in the bilge. The float switches are connected to the battery management panel and receive power from the breaker along the top of the panel. These breakers are constantly energized and ensure the safety of your boat even when the battery switches are in the "OFF" position. The pumps can be manually engaged using the switches located on the dash.

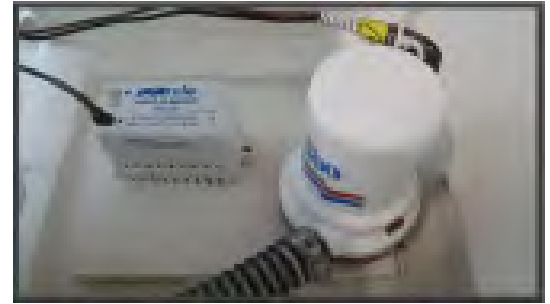

The aft bilge pumps are located behind the aft rigging compartment and can be accessed through the inspection plates in the motorwell, forward of the engines. The wiring for these pumps is secured on the outboard side of the centerline stringer which is visible from the inspection port. The forward pumps are located beneath the cabin liner. They can be reached through the inspection ports installed in the cabin floor on either side of the master berth.

Inspect the operation of your bilge pumps and their connections at least annually. To do so, activate the pump by momentarily lifting the arm on the float switch, then check the operation using the switches at the helm. When testing, do not allow the pumps to run dry for more than two to three seconds. Extended dry operation can result in damage to your pump. Keeping your bilge areas clean can also help extend the life of your pump.

#### 6.10.7 Seacocks

The Ball Valve (seacock) is installed on the water intake for the raw water system. The seacock must be in the open position for the system to work. When open, the handle will be parallel to the valve. In the closed position the handle is perpendicular to the valve (see picture below). World Cat recommends that the seacock remain in the closed position when not in use, or when the boat is left unattended to prevent the vessel from taking on water due to a plumbing failure.



OPEN



CLOSED

#### 6.10.8 Raw Water Pump

This pump supplies pressure to the raw water system. It contains a pressure switch similar to a residential well pump. You can leave this appliance on at all times while underway. The raw water pump and strainer are located in the starboard aft bilge area. They are accessed through the access panel located behind the starboard aft folding seat. The strainer is connected to a high speed pickup through the seacock located on the inboard side of the port sponson. The seacock must be open for the system to work. World Cat recommends that the seacock remain in the closed position when not in use, or when the boat is left unattended to prevent the vessel from taking on water due to a plumbing failure.





### 6.10.9 Freshwater Pump

The freshwater pump and wiring are located in the port aft bilge area. The freshwater pump is connected to the 35 gallon freshwater tank located beneath the port seatbox. The tank is filled through a fitting located on the port side of the deck. Similar to residential well pumps, the freshwater pump pressurizes the system to 45 psi. then shuts down until the pressure drops below that level. Most owners leave the pump "ON" throughout the day, and use the system when necessary. On your 296DC, the freshwater pump feeds the pull out shower located on the aft transom wall, the head faucet, and the marine head.

### 6.10.10 Macerator Pump

Used to evacuate waste and debris from fish boxes or to remove waste from marine head holding tanks. The pump is located behind the aft hatch above the floor drain in the head compartment. This 12V DC pump is self-priming up to 3' in lift. It has a 1.5" inlet barb and a 1" outlet barb for easy and direct installation. For your safety it is thermally protected and ignition protected.



### 6.10.11 Livewell and Livewell Pump

The livewell on your 296DC has a capacity of 30 gallons. It is equipped with a dual purpose livewell pump and adjustable flow regulator. The pump is located in the port bilge compartment, can be activated by a toggle switch on the dash switch panel, and can be reached through the inspection port in the motorwell. The wiring is secured to the pump using a tie-strap and must be disconnected prior to removing the pump.



The livewell pump draws water through the high speed pickup mounted on the inboard side of the port sponson. A seacock is installed between the pickup and the pump to allow you to seal the system between use, or in the event of a plumbing failure. To operate the livewell, first verify that the seacock and flow regulator are open, then install the drain plug in the bottom of the tub. When you have completed these steps, engage the livewell pump using the switch at the dash. The livewell light is also controlled by the switch. Water will fill the tank until it is level with the overboard drain, which evacuates water through the hullside. To clear bait residue from the tank during operation, temporarily remove the drain plug. When you have finished using the livewell, remove the drain plug to allow the water to drain overboard.

## NOTICE

While underway, leaving your livewell seacock open could result in inadvertently filling your livewell. To prevent this, close the seacock when the pump is not in operation.

## NOTICE

Operating the engines in reverse can cause excessive ventilation near the livewell intake, causing the pump to airlock. To prevent this, turn the pumps "OFF" prior to any continuous or high speed reverse operation. If your pump does become air locked, turn the pump "OFF" for 15 to 30 seconds to correct the problem.

### 6.10.12 USB Outlets

Located strategically throughout the boat, these outlets provide power to aftermarket accessories such as cell phones, electric reels, and spotlights. Each outlet is independently wired to the fuse panel.

**6.10.13 Anchor Windlass - Freefall**

Used to deploy and retrieve the anchor. This accessory is controlled by a dedicated switch at the helm and can also be controlled at the bow with up and down foot switches. The fuse is located at the battery management panel.

**6.10.14 Windshield Wipers (Optional)**

The pantograph-style, heavy-duty, waterproof windshield wipers with rinse are operated by a dedicated rocker switch at the helm and function identically to those found on passenger automobiles.

**6.10.15 Horn**

This functions identically to the horn found on a passenger automobile and is operated by the switch labeled "Horn" on the dash switch panel.

**6.10.16 Shower**

The 296DC features a shower head located portside aft. The shower is supplied water from the 35 gallon freshwater tank. For more information, view the diagram on page 56 and contact your dealer.

**6.10.17 Yamaha™ 300 HP 4-strokes with Command Link Plus**

The Yamaha™ F300 4.2L V6 Offshore outboards come preinstalled on your World Cat when purchased with this optional package. Yamaha recommends using regular unleaded (minimum pump octane 89) fuel and Yamalube® 4M engine oil. For additional information and specific operating instructions refer to your Yamaha™ owner's manual.

The Yamaha™ package includes the Command Link Plus. This twin engine combo screen displays data for both engines simultaneously. The customizable screen displays critical systems data, including: shift position, engine RPM, boat speed, engine trim level, available fuel in gallons, fuel level, fuel flow, fuel economy, and up to three vital engine functions of your preference.

**6.10.18 Fusion® Marine Entertainment System MS-UD750**

The FUSION® 750 Marine Entertainment System delivers excellent sound performance and media integration. Featuring 4 JL Audio speakers, remote control, an internal UNI-Dock for charging, environmental protection and playback of the latest compatible Apple iOS, MTP Windows / Android and USB media devices, including Bluetooth A2DP / AVRCP audio streaming capabilities, and support for advanced FUSION-Link™ NMEA 2000 / Ethernet / Wi-Fi / Bluetooth connectivity. For specific operating instructions refer to your FUSION® system owner's manual.

**6.10.19 Fusion® Marine Wired Remote MS-NRX200**

Manage the entertainment experience directly from the individual listening zone of your vessel with the MS-NRX200. Most stereo functions are replicated by the remote, with full control of the volume, balance and subwoofer level at your finger tips. Control every audio zone on your vessel from the unit or assign the remote a specific zone to control. For specific operating instructions refer to the FUSION® remote owner's manual.

**6.10.20 LED Underwater Light Package (Optional)**

Your World Cat offers optional LED surface mounted light utilizing the latest high powered LED's. These lights are installed on the port and starboard transom and can be turned on using the corresponding switch on the master switch panel.

**6.10.21 Accessory Switch (ACCY)**

The additional accessory switch (labeled: ACCY) on the 296DC dash panel that can be used to operate aftermarket products. Be aware of the power requirements for any add-on products, so you do not exceed the capacity of the breaker supplying the switch. Failure to do so could damage the appliance and / or the electrical system.

### 6.10.22 Optimus Electronic Power Steering Package (Optional)

The Optimus Electronic Power Steering package provides increased comfort, lighter steering loads, and car-like steering response when on the water. See the Optimus EPS user's manual for additional information.

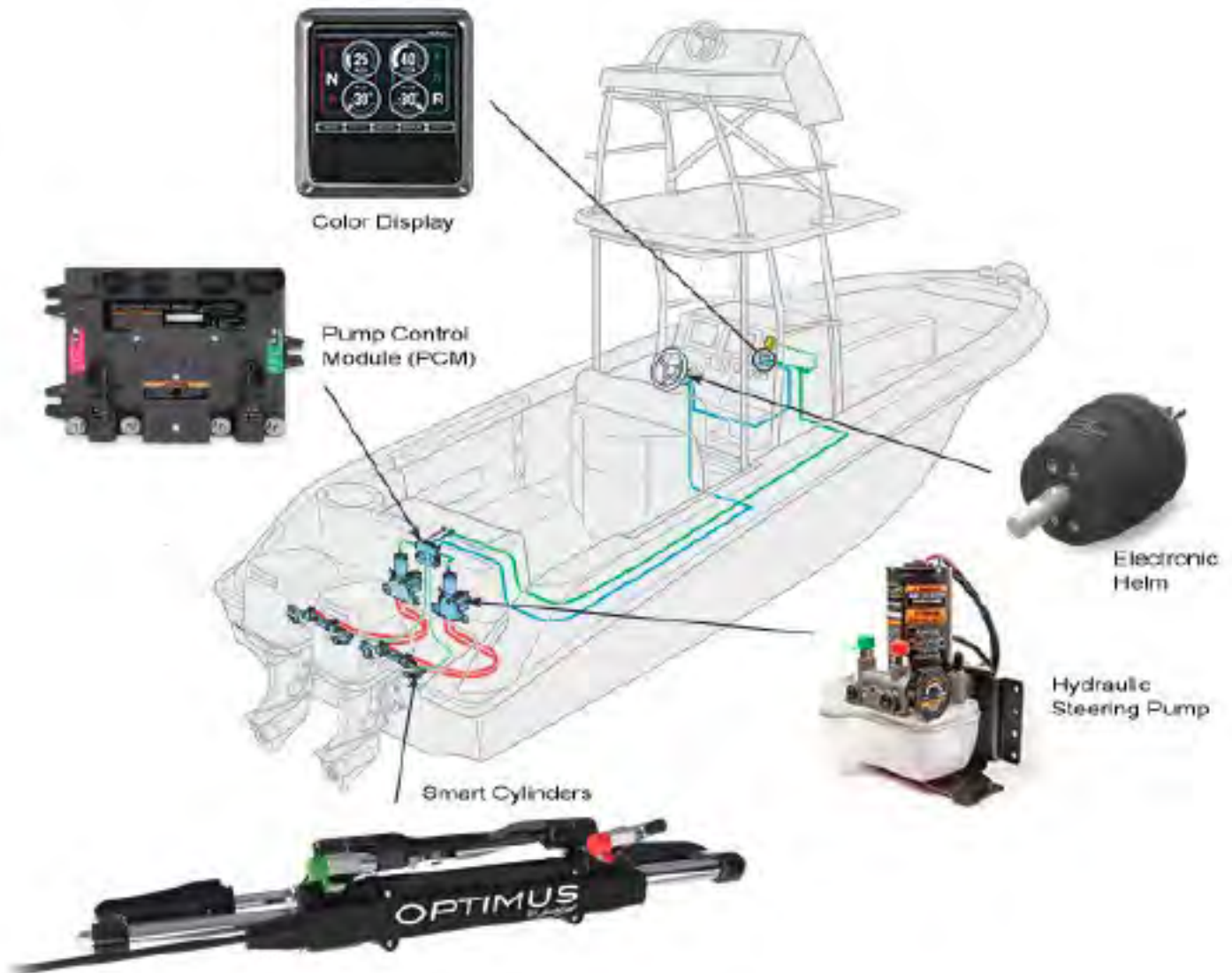

#### Features:

- User adjustable speed sensitive helm turns, wheel effort, and steering response
- Fault tolerant CAN Bus network
- Sealed, locking cable connections
- On-demand hydraulic steering pumps
- Rigged with Kevlar-reinforced hydraulic hoses
- Adjustable stainless steel ORB fittings on the SmartCylinder
- Redundant systems for fail-safe operation

### 6.10.23 Optimus 360 with Electronic Steering, SeaStation, Joystick, and SeaWays Autopilot (Optional)

The Optimus 360 package includes Electronic Power Steering, Electronic Joystick Control System, and Seaways Autopilot. Using state-of-the-art electronics, it provides easy 360 degree maneuvering capabilities when docking, negotiating crowded areas, or loading a vessel onto a trailer. See the Optimus 360 user's manual for additional information.

### Optimus 360 System Schematic

Optimus EPS + Joystick =  
Optimus 360 Joystick Control

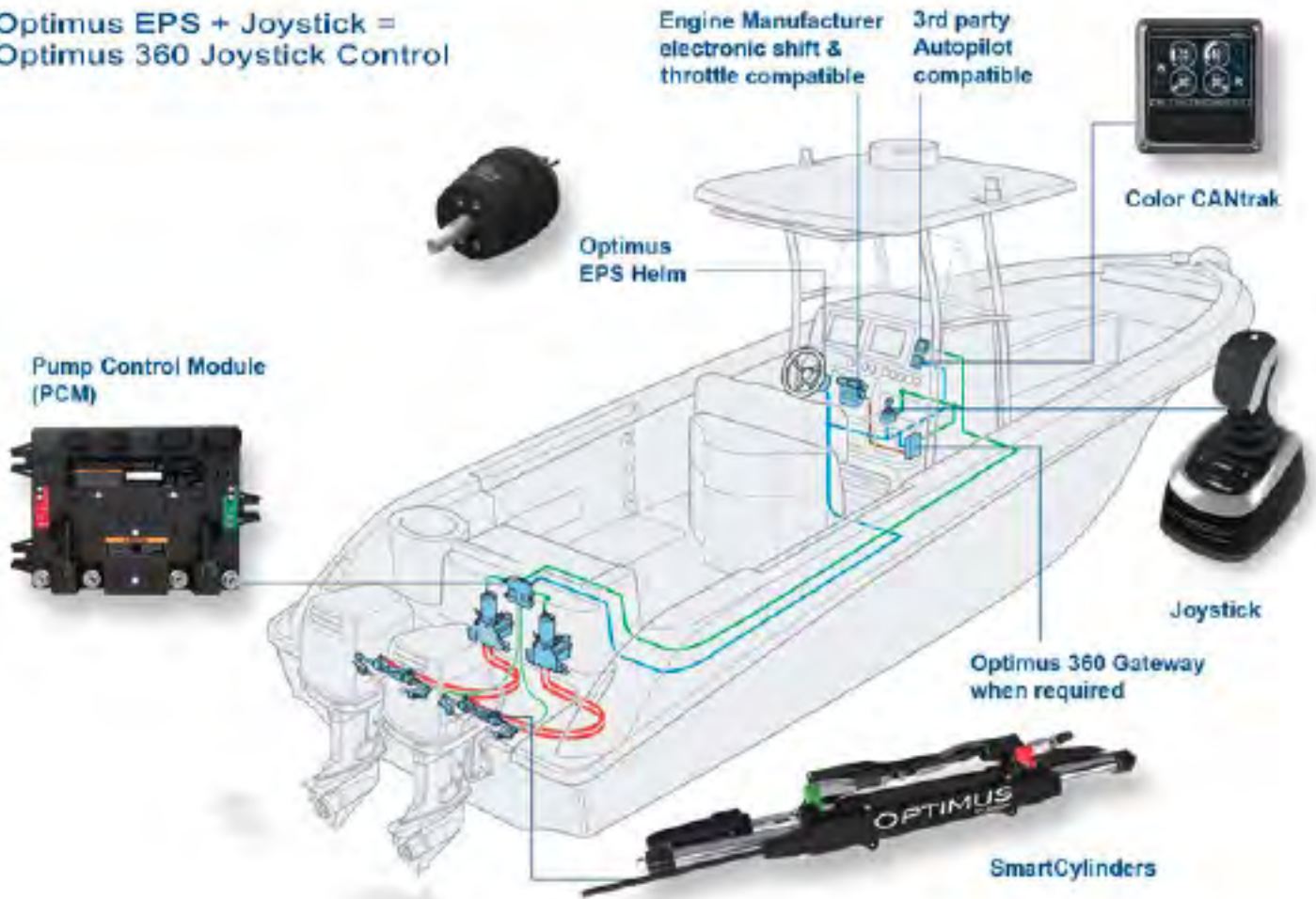

#### Features:

- Three axis joystick with guided feel and boost mode
- Unique joystick design with a focus on user ergonomics and harsh marine environments
- User adjustable speed sensitive helm turns, wheel effort, and steering response
- Fault tolerant CAN Bus network
- Sealed, locking cable connections
- On-demand hydraulic steering pumps
- Rigged with Kevlar-reinforced hydraulic hoses
- Adjustable stainless steel ORB fittings on the SmartCylinder
- Compatible with 3rd party autopilot systems
- Redundant systems for fail-safe operation
- Adjustable stainless steel ORB fittings on the SmartCylinder
- Redundant systems for fail-safe operation



### 6.10.24 Marine Head

The marine head is powered by the fuse panel, and has a separate control panel mounted near the head. Water is supplied to the system from the freshwater tank; therefore, to operate the toilet the freshwater system must be pressurized. A solenoid, installed near the head inlet, prevents water from filling the bowl prior to each use. The macerator pump, located at the rear of the toilet, removes waste from the bowl and pumps it into the 15 gallon holding tank. The control panel activates the solenoid to allow for water intake and discharge.



## !!! WARNING

If the solenoid fails or becomes locked in the open position, shut off the supply system quickly and evacuate the bowl.

### Control Panel Operations

The top rocker switch will flush the toilet and fill it at the same time once the switch has been depressed to the right.

The bottom rocker switch performs two functions:

- If depressed to the left it will fill the toilet to a desired level for user comfort.
- If depressed to the right the toilet will be evacuated.

### Initial Start Up

On each trip, prior to using the head, complete the following steps:

- Turn on the freshwater system.
- Fill 1/3 of the bowl with water using the lower switch on the control panel.
- Hold down the top switch for 5 seconds to evacuate the bowl and refill with water.



### Normal Use

Use the steps below for normal operation:

- Hold the upper switch on the panel down for 5 seconds. This will purge the bowl and refill it with water.
- In the event of inclement weather or rough seas, use the lower switch to remove water from the bowl and prevent sloshing.

### Deck Pump Out

## !!! CAUTION

Large quantities of waste or paper can clog the head and cause odor issues. To prevent this, flush often and if necessary perform an extra flush to purge the discharge line.

## !!! CAUTION

Do not dispose of foreign objects in the head. Doing so may damage the macerator pump or outlet hoses. Clogging or puncturing these lines will lead to odor problems.

Upon returning, use the following instruction to empty the holding tank:

- Remove the cap from the deck pump-out fitting located on deck, outboard of the helm position.
- Use the vacuum hose at the pump-out station to clean the tank, then remove the hose and replace the deck fitting.

### Overboard Discharge

Use the following steps to discharge the contents of the holding tank overboard:

- Open the overboard discharge seacock which is located inside the aft hatch in the head. The seacock must be in the open position before attempting to discharge the waste from the waste tank. Use the key switch located on the head switch panel to evacuate the tank.
- Inspect the tank level and repeat if needed, otherwise close the discharge seacock.

## !!! CAUTION

Discharging waste in inland waters and some coastal areas is illegal. Check with local and state authorities in your region to determine the proper method for waste disposal.

### 6.10.25 Plumbing System

The intake and discharge of water is integral to several of the features and accessories provided on your boat, including sanitation devices and water systems. World Cat installs the plumbing components for these systems using high quality marine hoses and stainless clamps. However, this does not eliminate the need for routine checks of plumbing components or connections. A failure resulting from a deteriorated hose or connection could cause your boat to take on water or become swamped. For additional information about the plumbing system refer to the plumbing system diagram and speak with your dealer.

### 6.10.26 ProMariner ProSport-20 2-Bank Battery Charger (Optional)

ProSport Marine Battery Chargers provide automatic installation feedback with its exclusive "System Check OK" and individual "Battery Bank Trouble" LED indicators. After fully charging and conditioning batteries, ProSport's Energy Saver Mode will monitor and Auto Maintain batteries only when needed to maintain a full state of charge, resulting in maximum reserve power performance and lower AC power consumption and operating costs. The unit is 100% waterproof / shockproof and includes 4 digitally-selectable charge profiles including a once-a-month storage reconditioning mode for extending battery life. For specific operating instructions refer to the ProMariner ProSport owner's manual.



### 6.10.27 Windshield

The center windshield panel should be closed and latched at any time the boat is underway.

### 6.10.28 Outriggers (Optional)

Outriggers enhance the fishability of your catamaran and can be a great asset when hunting a trophy catch. World Cat offers Taco™ outriggers as an option. The units are mounted on the fiberglass hardtop and operated using the handles above and outboard of the walkthrough. Use the information provided in section 7.6 to maintain the aluminum on the outriggers and grease the telescoping joints frequently to prevent damage from salt spray.

### 6.10.29 SureShade Pull-Out Boat Shade (Optional)

The SureShade is mounted underneath the fiberglass hardtop in the aft cockpit of the vessel. To operate the shade, make sure the vessel has come to a complete rest. You will need to rotate the hand crank located in the starboard aft upper corner of the hardtop. This crank extends and retracts the shade to the extended and closed position. The manufacturer recommends that this shade not be extended or retracted while the vessel is in motion. Please make any adjustments only when the vessel has come to a complete rest.

## !!! CAUTION

SureShade pull-out boat shade is not to be operated while boat is underway. Damage to boat, or personal injury, could occur if shade is extended or retracted while underway.

## Chapter 7: Maintenance and Service

### 7.1 Overview

This chapter provides basic information for maintaining the original appearance and dependable performance of your World Cat. Although your vessel is constructed of the finest materials available, the harsh saltwater environment and other factors, including geography and usage rate, will affect its finish and function over time. It is imperative that you understand how to care for your catamaran properly. Some simple steps will help maintain its aesthetics, value, and reliability.

### 7.2 Gelcoat Maintenance

Gelcoat is a thin layer of resin mixed with colored pigments, which provides the exterior finish on your boat. Gelcoat provides a smooth durable surface to protect the fiberglass construction of the hull, but is still flexible enough to absorb the pressure exerted upon it during operation. Mainly used for cosmetics, gelcoat is relatively simple to maintain. However, without routine cleaning, it will discolor due to the microscopic pores in the surface.

#### 7.2.1 Cleaning

After each trip on the water, or after trailering long distances, you should clean the boat immediately. Washing the boat with mild detergents, such as dishwashing soaps, and fresh water will help eliminate build up or discoloration resulting from environmental pollutants. Use a sponge or other soft cleaning device on the smooth exterior surfaces of the hull and deck. A soft brush can be used when cleaning nonskid portions of the deck. Make sure to rinse the boat thoroughly after cleaning.

### !!! CAUTION

Using strong or caustic cleaning agents, such as bleach, citrus based cleaners, or one containing ammonia, will damage the appearance and strength of your gelcoat.

#### 7.2.2 Waxing

Similar to automotive finishes, gelcoat will begin to fade over an extended period of time. Constant exposure to environmental pollutants will result in a loss of shine. However, it is possible to restore the original luster and color using a polishing compound (mild abrasive) or a rubbing compound (harsh abrasive). Each will remove scratches, discoloration, and help restore weathered gelcoat surfaces. You should select which compound to use based on the severity of the problem

#### **Use the following steps to restore the finish of your gelcoat.**

(Note that these procedures assume a moderate level of expertise of the person performing the work. If there is any doubt about ability to successfully accomplish the procedure, for best results it may be best to turn the process over to a professional.)

- Clean the affected area completely using a mild detergent.
- Gently wet sand the affected area using a fine sandpaper (600 grit) to remove any stains. Use plenty of water and always sand in one direction using curved strokes. Sanding in alternating directions could result in damage to the finish.
- Apply polishing compound to a buffing pad and follow the manufacturers instructions. If you apply the compound mechanically, we recommend a lamb wool buffing pad and a electric buffer capable of 1750 to 1800 RPM.
- When you have completely buffed the area, wash away any remaining compound using clean water.
- After thoroughly cleaning the surface, wax the affected area. This will help restore the finish and provide a seal against future discoloration.

**!!! CAUTION**

Using strong or caustic cleaning agents, such as bleach, citrus based cleaners, or one containing ammonia, will damage the appearance and strength of your gelcoat.

**!!! CAUTION**

When using an electric buffer, maintain constant motion. Allowing the pad to rest on an isolated spot can cause heat buildup, which can damage the gelcoat.

**!!! CAUTION**

Routinely clean and wax your catamaran to help prevent the need for excessive use of rubbing and polishing compounds, which over time can deteriorate the gelcoat.

By following the instructions listed above you can guarantee that your catamaran will remain in near showroom condition and remain a source of pride for years to come.

**7.2.3 Repair**

Although gelcoat is a flexible material capable of handling environmental punishment and extended use, it is susceptible to scratches, blistering and cracking over time. Gelcoat distortion or cracking is unappealing, but rarely represents any structural failure. Have your dealer inspect any damage to your gelcoat to determine the nature of the failure. If it is only cosmetic, they can provide color matched kits, instructions, and any chemicals you need for application or cleanup. Structural damage should be repaired by your dealer or a qualified fiberglass repair shop.

**!!! WARNING**

Gelcoat and the chemicals used for its application and cleanup are extremely flammable and toxic. Follow all handling and mixing instructions, provide for proper ventilation, and keep water containers nearby to submerge catalyzed materials.

**7.3 Bottom Paint**

If you intend to leave your boat in wet storage, or routinely dock it for more than a few days, you should coat the hull beneath the water line with anti-fouling paint. This will help prevent marine growth, such as barnacles, which damage the gelcoat and affect performance. World Cat recommends using an epoxy barrier coat prior to painting a new vessel. This will help to prevent, but will not eliminate, gelcoat blistering on the hull, which is not covered by the warranty. Your dealer can provide information on bottom painting to protect against environmental toxins in your area. Anti-fouling paints are made to dissolve over time, so inspect and clean the hull bottom annually and recoat when necessary.



## 7.4 Upholstery

**Basic Stains** - Clean with a mild detergent and a soft to medium brush, or an all-purpose cleaner and rinse well with fresh water after cleaning.

**Mildew** - Use a 4 to 1 mixture of water and ammonia, brushing the stain vigorously to remove the bacteria responsible for the mildew. If the stain remains, briefly apply bleach to the area and rinse with fresh water.

**Tough Stains or Mildew** - Use a mixture of 1 tablespoon of ammonia, 1/4 cup of hydrogen peroxide, and 3/4 cup distilled water. Briefly, apply to the surface, allowing the peroxide to bubble. Rinse with fresh water.

### !!! WARNING

Do not mix ammonia and household bleach. Doing so will result in the formation of deadly chlorine gas. If it is necessary to use bleach, clean up any traces of ammonia and ventilate the work space for a minimum of 15 minutes prior to applying bleach.

## 7.5 Trim / Plexiglass / Polyethylene

World Cat uses vinyl, plexiglass, and polyethylene material (Starboard™) throughout the interior of our catamarans.

### Use the following instructions to care for these items:

- Use mild detergents to clean vinyl trim commonly used in cabins and helm. Routinely use a commercially available surface protector to seal the vinyl.
- Surface or glass cleaners can be used to clean plexiglass. It is commonly used for radio boxes and as a protective material for instrument panels.
- Starboard™ can be cleaned using surface cleaners such as 409™.

## 7.6 Stainless Steel / Aluminum

Stainless steel and aluminum are used throughout your vessel. World Cat uses only 316 marine grade stainless hardware and anodized aluminum to provide you with years of service; however, these metals can deteriorate and fail if improperly cared for. Upon returning, clean all hardware using a mild detergent and rinse thoroughly with fresh water. Avoid using abrasive cleaners or chlorine based products, as they will remove the metal's protective coating and lead to pitting or rust. Throughout the year, coat the metal using a non-abrasive metal protector to help displace moisture, remove contaminants, and shield the metal. World Cat recommends high quality sealants such as Boeshield T-9™ developed by Boeing™ Aviation. If you cannot find it locally call PMS Products Inc. at 800-962-1732.

## 7.7 Bilge Compartments

Routinely check the condition of the bilge compartments in your boat. This will help identify potential problems and eliminate odors associated with stagnant water and the buildup of residue. Clean the compartments using a freshwater rinse. This will also enable you to check the function of your drain system and the operation of the bilge pumps.

## 7.8 Cockpit Drains

All World Cats have four drains located in the cockpit, two on both the starboard and port sides. These drains are designed to quickly evacuate the cockpit should the boat become swamped. Flushing these drains routinely will ensure the safety of your crew and vessel, as well as eliminate the potential for odors associated with fish residue. These drains are evacuated through the scuppers located on the hull side. Each scupper has a rubber flap to prevent water from entering the boat. Check this material occasionally to keep the scuppers free of debris and in good working condition.

## 7.9 Winterization

Routine maintenance checks should be performed prior to each trip in accordance with Chapter 1, but a broader assessment should be done before winterizing your catamaran and prior to the first trip of the season. If your local climate does not require winter storage, complete the following steps at least annually to ensure the safe operation of your boat:

- Do not leave loose items or personal effects onboard during storage. Remove all trash and debris prior to cleaning the boat.
- Before storage, clean the boat thoroughly, including exterior surfaces, fish boxes, livewells, and thru hull fittings. If possible, leave lids open slightly to allow fresh air exchange.
- Remove the garboard drains and store the boat with the bow up to allow drainage.
- Inspect all electrical connections and the operation of pumps or other electrical devices.
- Perform repairs if necessary. Coat electrical panels with an anti-corrosive spray (available from your dealer).
- Inspect the batteries and charge fully to prevent damage during storage.
- Disconnect the cables and apply a coat of grease to the terminals to prohibit corrosion.
- Inspect all plumbing components and connections to prevent leaks.
- Replace any damaged hoses.
- Drain all lines and devices to prevent damage from freezing.
- Lubricate valves to maintain proper operation.
- Use the manufacturer's recommendations for portable and marine heads.
- Inspect fuel system components and replace fuel / water separators. You can keep the system fueled but do not overfill, and use a fuel additive to prevent condensation.
- Lubricate hinges and coat all metal surfaces with a metal protecting compound. Tighten down any hardware if necessary.
- Inspect caulking around hardware, windows, hatches, etc., to prevent water damage. Normal use will break down sealants and can lead to costly repairs if not maintained.
- Remove or cover all electrical devices to prevent damage from UV rays. The rays will cloud electrical displays and make them hard to read.
- Remove cushions and store indoors to prevent damage.
- Winterize the engines and controls per manufacturer's recommendations and inspect all connections, filters, and parts thoroughly. Replace parts as needed.

**7.10 Maintenance Schedule**

<b>Maintenance</b>	<b>Each Use</b>	<b>Weekly</b>	<b>Monthly</b>	<b>Quarterly</b>	<b>Yearly</b>	<b>As Needed</b>
Clean hull below the waterline				X		X
Bottom paint the hull					X	X
Check / replace sacrificial anodes			X			
Wash boat hardware and canvas	X		X			
Wax exterior gelcoat				X		X
Clean & protect hardware						X
Clean exterior upholstery	X					X
Clean cabin & interior upholstery						X
Flush engines with fresh water	X					
Spray metal components in bilges			X			
Clean bilge				X		X
Check bilge for leaks	X		X			
Inspect steering & controls	X					
Inspect fuel systems for leaks	X					
Replace fuel filters					X	X
Lubricate fuel fill o-rings			X			
Inspect fire extinguisher			X			
Test bilge pump auto switches	X		X			
Check battery electrolyte & service			X			
Check proper functioning of pumps	X					
Replace pumps					X	X
Replace gaskets						X
Inspect & operate thru-hull valves			X			



## Chapter 8: Hurricane Preparedness Customer Checklist

### Equipment To Be Kept On Board:

- Chafing gear
- Fenders
- Flashlight with spare batteries
- Two sufficient anchors with 300' or more oversized rode
- Battery-operated radio

### Check Monthly:

- Exterior lights operable
- Auto bilge pump operating (check battery)
- Hatches are watertight
- Power and electric gear operating
- Engine battery charged
- Flashlight battery charged
- Radio batteries charged

### To Do At A New Marina:

- Learn marina approaches and basin.
- Learn the size and type of your mooring.
- Ensure mooring and lines are sufficient for all likely wind direction and velocity.
- Ensure mooring has enough weight and scope and is properly set.
- Learn your moorage lease and rental agreement responsibilities.
- Learn responsibilities for your boat's safety when a hurricane is approaching.
- Develop a plan for securing your vessel outside the marina if you plan to evacuate.
- If evacuating, visit the site by boat and time the trip.
- Learn what possible delays you may encounter when evacuating (drawbridges, boat traffic ,etc.).
- Photograph your boat and surroundings.
- Keep a list of all equipment on board.
- Keep a list of all equipment that will be removed during storm preparations.
- Keep a complete set of records for your boat at home.
- Give the marina operator the name and number of your absentee skipper.
- Give the marina operator a description of your boat, registration number and location.

### Docked Boat Preparations:

- Strip all removable items, including spare rigging.
- Clear self-bailing cockpit drains.
- Close all thru-hull fittings.
- Set chafing gear where lines will rub (chocks, cross lines, deck edge, dock edge etc.).
- Remove portable fuel and oil storage containers.
- Remove ship papers.
- Shut off fuel tanks.
- Leave anchor light on.
- Leave auto bilge pump on.
- Check openings to ensure boat is watertight.
- Set and check storm anchors.
- Consider attaching 3 sets of bow and stern spring lines.
- Consider attaching lines to cleats at a 45 degree angle.
- Consider tying your boat between two piers or along a pier and anchored off one side.

## Moored Boat Preparations

### Make Plans To Have Someone Pick You Up From Your Boat Before The Storm Arrives

- Strip all removable items, including spare rigging.
- Clear self-bailing cockpit drains.
- Close all through hull fittings.
- Remove portable fuel and oil storage containers.
- Remove ship papers.
- Shut off fuel tanks.
- Leave anchor light on.
- Leave auto bilge pump on.
- Check openings to ensure boat is watertight.
- Use storm pennants to increase scope.
- Attach chains directly to pennants instead of swivels.
- Add an emergency catenary weight at the vessel end of the chain.
- Use double or triple chafe protection.
- Use chafing gear over entire length of pennants.
- Use two pennants.
- If no permanent mooring is available, use two storm anchors at 45-degree angles.

### Trailerable Boat Preparations

*Store in a garage:*

- Strip all removable items, including spare rigging.
- Clear self-bailing cockpit drains.
- Close all thru-hull fittings.
- Remove portable fuel and oil storage containers.
- Remove ship papers.
- Shut off fuel tanks.
- Leave auto bilge pump on.
- Check openings to ensure boat is watertight.
- 
- 
- 

*If no garage is available:*

- Secure trailer to a sturdy object.
- Let half the air out of the trailer tires.
- Put wood blocks between the frame and axle.
- Take out the drain plugs.
- Cover with tarp.
- Use tie-downs.
- 
- 
-

## Anchored Boat Preparations

### Make Plans To Have Someone Pick You Up From Your Boat Before The Storm Arrives

- Strip all removable items, including spare rigging.
- Clear self-bailing cockpit drains.
- Close all thru-hull fittings.
- Remove portable fuel and oil storage containers.
- Remove ship papers.
- Shut off fuel tanks.
- Leave auto bilge pump on.
- Check openings to ensure boat is watertight.
- Use 3 or 4 substantial anchors and good tie rope.
- Tie your boat high on the mainland to a substantial tree or similar structure.
- Do not tie parallel to the bank.
- Keep a navigable passage at your stern to allow other boats passage.
- Use enough line to allow for storm surge.
- Leave enough room between your boat and others to allow for swing.
- Take valuables off.
- 
- 
- 
-



## Chapter 9: 2019 Warranty Policy



# 2019 MODEL YEAR LIMITED WARRANTY

Congratulations on the purchase of your World Cat product. We want you to have years of pleasure and fun aboard your new World Cat boat. This document is your Limited Warranty. It describes the terms and conditions of the warranty agreement between us. It applies to all World Cat Products sold under the World Cat or Glacier Bay Edition brands manufactured beginning with the 2019 Model Year. Your Model Year is identified by the Hull Identification Number ("HIN"), which is unique to every boat and is located on the stern.

It is important to understand what a limited warranty does. It is an agreement between you and World Cat that your vessel will be free from substantial defects in material and workmanship for a specified length of time. However, if a defect does occur, you and World Cat agree that you will allow World Cat to repair it or, at our discretion, replace it as set forth herein. All products need repairs and maintenance from time to time, especially boats. Boats have a rough life in that they often go long periods between use, and when they are used, boats must perform in a difficult environment. Because of this, you should understand what your limited warranty does and does not cover and the terms and conditions that apply to it. Please note that there are disclaimers and limitations on page two of this Limited Warranty.

### I. LIMITED WARRANTY

1. **Ten Year Limited Hull Warranty.** World Cat warrants that it will repair, or at its sole and exclusive discretion, replace any substantial defect in material or workmanship in the hull (defined as the one-piece fiberglass molded part that acts as the vessel's running surfaces) for the first ten (10) years following the date of purchase by the original retail owner. In the event that World Cat determines that your hull must be replaced, you agree to give us back the original hull and we will put a new hull on your boat. The replacement hull will be an upgraded model if the original model is no longer offered. Transfer of all accessories, including engines and electronics, will be at owner's expense.
2. **One Year Limited Material And Workmanship Warranty.** World Cat warrants that it will repair or, at its sole and exclusive discretion, replace any substantial defect in material or workmanship in any other parts or components of the boat that do not carry their own, separate written warranty, for a period of one (1) year following the date of purchase by the original retail owner. *Under no circumstances will World Cat warrant the engine, trailer or electronics.*

### II. WARRANTY LIMITATIONS

#### **THIS LIMITED WARRANTY DOES NOT COVER THE FOLLOWING:**

1. Defects and/or damage arising out of engines transmissions, running gear and outdrives, metal plating or finishes, windshield breakage, and leakage due to seal and/or caulk shrinkage and/or normal wear and tear;
2. Defects and/or damage to gel coat or painted surfaces including, but not limited to, discoloration, fading, chalking, and/or osmotic blistering;
3. Defects and/or damages related to accessories, alterations, modifications or installations which were not part of the boat when shipped from the World Cat factory, and/or not authorized in writing by World Cat;
4. Damage and/or defects related to misuse, such as groundings and impacts with docks, pilings, navigation buoys, etc.; accidents; reckless, unsafe or improper use relative to existing sea conditions; lack of recommended maintenance, or improper trailering, blocking or lifting; and/or repairs by the owner or other persons without prior, written authorization from World Cat;
5. Use of the boat for competition, racing, or used for rental, business or commercial purposes without the prior written authorization of World Cat. Rental, racing, business or commercial use without prior, written authorization voids this warranty;
6. Defects and/or damage related to operation of the boat in violation of any Coast Guard regulations or other governmental laws, rules, or regulations;
7. Mildew, water damage, dry rot, staining or water absorption on interior materials and/or surfaces including but not limited to upholstery, cushions, cabinets or floor coverings, as a result of sustained exposure to humid conditions.
8. Galvanization and/or electrolysis or and other damage caused or contributed to by stray electrical current.
9. Defects, injury, costs or damages arising out the use of engines with a rated horsepower exceeding the maximum rated horsepower for each model as defined by World Cat Boats or as reflected on the capacity label.

### III. CUSTOMER OBLIGATIONS:

1. You must sign and submit to World Cat the "LIMITED WARRANTY REGISTRATION FORM" within thirty (30) days of the date of delivery. Your dealer can do this for you, but it is up to you to request them to do so. **THE REGISTRATION FORM IS NOT A WARRANTY AND MAY NOT BE USED TO MODIFY OR CONFLICT WITH ANY TERMS OF THIS LIMITED WARRANTY;**
2. In the event you discover a defect, you must first notify the dealer from whom the boat was purchased within a reasonable period of time (not to exceed thirty (30) days) after you know or should know the defect exists;



## 2019 MODEL YEAR LIMITED WARRANTY

3. World Cat will not be responsible for damage or to continue to repair or replace your boat or any part of it if your continued use prior to repair causes additional damage;
4. If you believe a claim has been denied in error or the dealer has performed the warranty repairs in an unsatisfactory manner, the owner must notify the World Cat Customer Service Department in writing within thirty (30) days of the repair attempt at the address listed below under "Notice." World Cat will then review your claim and take appropriate follow-up action.
5. You should keep records of all maintenance services. This record of proper maintenance may be required to determine warranty coverage on certain repairs and should be transferred to each subsequent owner. Please refer to the Owner's Manual that came with your boat for the proper maintenance procedures.
6. In the event a repair must be made at a factory authorized repair center or at the World Cat factory, transportation to and from the repair center shall be made at the Customer's expense and not at the expense of World Cat or its authorized dealer.

### IV. TRANSFERABILITY

You can transfer the unexpired term of this limited warranty once to a new owner, provided that the transfer occurs during the first (5) five years after the date of purchase. A copy of the bill of sale from the original owner is required, as well as completion of the transfer form. The new owner must register the transfer of limited warranty within 30 days of purchase, by sending a written request to the address listed in the **Notice** section below along with a registration fee of \$395. World Cat reserves the right to reject any warranty transfer request for a boat that has been damaged, neglected or otherwise previously excluded from warranty coverage.

### V. DISPUTE RESOLUTION

#### MANDATORY MEDIATION BEFORE SUIT

IN THE UNLIKELY EVENT WE CANNOT AGREE ON A RESOLUTION OF ANY ISSUE REGARDING YOUR BOAT AND/OR THE TERMS OF THIS AGREEMENT, OR IN FACT OF ANY ISSUE ARISING BETWEEN YOU AND WORLD CAT AND/OR A WORLD CAT DEALER, YOU AND WORLD CAT AGREE TO SUBMIT THE DISPUTE TO MEDIATION. MEDIATION IS A SETTLEMENT CONFERENCE BEFORE A TRAINED MEDIATOR THAT YOU AND A WORLD CAT REPRESENTATIVE WITH AUTHORITY TO RESOLVE OUR DIFFERENCES ARE REQUIRED TO ATTEND. WE WILL PAY THE COSTS OF MEDIATION, BUT WORLD CAT WILL NOT BE RESPONSIBLE FOR TRAVEL EXPENSES, OTHER COSTS OR ATTORNEY FEES. YOU AND WORLD CAT WILL SELECT A MUTUALLY AGREEABLE MEDIATOR TOGETHER. IF WE CANNOT AGREE, THEN ANY JUDGE WITH POTENTIAL JURISDICTION OVER THE CASE WILL SELECT THE MEDIATOR. THE MEDIATION WILL BE AT A MUTUALLY AGREEABLE LOCATION BUT IT WILL ALSO BE WITHIN 100 MILES OF THE PLACE OF PURCHASE UNLESS OTHERWISE AGREED. YOU AGREE THAT NO LAWSUIT OR ARBITRATION OR ADMINISTRATIVE ACTION OF ANY KIND FOR ANY TYPE OF DAMAGE OR REMEDY MAY BE REQUESTED OR FILED UNTIL THIS MEDIATION IS COMPLETED. THE MEDIATION SHALL BE COMPLETED WITHIN SIX MONTHS OF THE FIRST DEMAND BY YOU OR WORLD CAT TO MEDIATE UNLESS OTHERWISE AGREED.

### VI. DISCLAIMER OF IMPLIED WARRANTIES

THIS IS A LIMITED WARRANTY. WORLD CAT MAKES NO WARRANTY, OTHER THAN AS CONTAINED HEREIN AND NO DECALS, PROMOTIONAL LITERATURE, BROCHURES, WEBSITE MATERIALS AND/OR PRE-DELIVERY SERVICE INSPECTION RECORDS/FORMS OR BROCHURES SHALL BE CONSTRUED AS ANY ADDITIONAL OR SEPARATE WARRANTY. TO THE EXTENT ALLOWED BY LAW, ALL WARRANTIES OF MERCHANTABILITY, WORKMANSHIP, SEAWORTHINESS OR FITNESS FOR A PARTICULAR PURPOSE ARE DISCLAIMED AND EXCLUDED.

### VII. LIMITATION OF REMEDY AND EXCLUSION OF CERTAIN DAMAGES

ALL INCIDENTAL AND/OR CONSEQUENTIAL DAMAGES ARE EXCLUDED FROM THIS LIMITED WARRANTY. YOU AND WORLD CAT AGREE THAT YOUR SOLE AND EXCLUSIVE REMEDY UNDER THIS LIMITED WARRANTY (AND ANY IMPLIED OR STATUTORY WARRANTY) IS THE REPAIR OR REPLACEMENT OF THE VESSEL OR DEFECTIVE COMPONENT AS SET FORTH ABOVE. NO OTHER LEGAL OR EQUITABLE REMEDIES SHALL BE AVAILABLE TO YOU IN RETURN FOR THE BENEFITS OF THIS LIMITED WARRANTY.

### VIII. PERFECT TENDER

A "PERFECT TENDER" MEANS THAT WE HAVE A RIGHT TO REPLACE YOUR BOAT IF, IN OUR DISCRETION, THE CLAIMED DEFECT REQUIRES REPLACEMENT AND WE AGREE TO DO SO IMMEDIATELY. FOR THESE PURPOSES, "IMMEDIATELY" MEANS WITHIN NINETY (90) DAYS FROM THE DATE YOU FIRST NOTIFY US THAT YOU BELIEVE THAT WE HAVE FAILED TO HONOR THIS LIMITED (OR ANY OTHER) WARRANTY AND/OR OTHERWISE FAILED TO PROPERLY REMEDY A SUBSTANTIAL DEFECT. IN THE EVENT YOU NOTIFY US IN WRITING, PER THIS AGREEMENT, OF A FAILURE ON OUR PART AND WE AGREE TO REPLACE YOUR BOAT WITH A NEW BOAT AS DESCRIBED IN YOUR ORIGINAL PURCHASE AGREEMENT, THEN IN THE EVENT YOU REJECT THE OFFER OF A NEW BOAT AND FILE A LAWSUIT OR OTHER LEGAL CLAIM, YOU AGREE THAT IN RETURN, WORLD CAT WILL BE NOT RESPONSIBLE FOR YOUR ATTORNEY FEES AND COURT COSTS. IF YOU HAVE FINANCED THE BOAT, YOU MUST EITHER



## 2019 MODEL YEAR LIMITED WARRANTY

PAY OFF THE AMOUNT YOU OWE BEFORE WE DELIVER THE NEW BOAT OR WE WILL ASSIST YOU TO SUBSTITUTE THE NEW BOAT AS COLLATERAL. WE ARE NOT RESPONSIBLE FOR PAYING OFF YOUR PRESENT BOAT

### IX. OTHER TERMS AND CONDITIONS

This limited warranty gives you specific legal rights, and you may also have other rights, which may vary from state to state. Some states and/or federal laws do not allow limitations to implied warranties or as to remedies or certain damages, so the above disclaimers and/or limitations may not apply to you.

World Cat will discharge its obligations under this warranty as quickly as possible, but we *cannot guarantee any specific completion date*. This is due to the potential complexity of the repair or the availability of parts from sources over which World Cat has limited control. You agree that the time for repairs does not include time spent waiting for parts or the time your boat may end up stored at our factory or at a dealer for your convenience or due to scheduling.

World Cat reserves the right to change or improve the design of its boats, without obligation to modify any boat previously manufactured. World Cat shall in no way be responsible for any repairs not PRE-AUTHORIZED by a World Cat Customer Service Manager or repairs performed by a repair shop not PRE-AUTHORIZED by a World Cat Customer Service Manager. "PRE-AUTHORIZED" means that we have prior approval in how the repairs are performed *before* they are performed.

### X. NO WAIVER OF THESE TERMS

The terms, conditions, limitations and disclaimers contained herein cannot be waived except by a management level employee of World Cat. Any waiver we give shall be in writing. Neither the dealer, nor any service, sales and/or warranty representative of World Cat are authorized to waive and/or modify these conditions, limitations and/or disclaimers.

### XI. NOTICE:

All communications and notices from you and/or a new owner requesting a transfer of this limited warranty should be sent to: World Cat Customer Service, 1090 West Saint James Street, Tarboro, NC 27886 or faxed to 919-882-8035. You can also email us at: [service@worldcat.com](mailto:service@worldcat.com), but you must request an acknowledgment that our Customer Service Department actually received it.

#### Acknowledgment of Limited Warranty.

By signing below, you agree that you have read this limited warranty in its entirety and understands its terms and conditions. You acknowledge that you have received a copy of this limited warranty at or before the time of the sale.

### WARRANTY REGISTRATION

Purchaser's Name	Purchaser's Phone Number
Purchaser's Street Address	Date of Delivery
Purchaser's City, State and Zip Code	Hull Identification Number
Purchaser's Email Address	Boat Model
Purchaser's Signature	Selling Dealer
	Dealer's Sales Representative

Check one:  Original Owner  Second Owner

## Chapter 10: Lewmar Deck Switch and Winch Operation



### Deck Switch Advisory

#### Overview

Electric deck switches operate in a hostile environment and are subject to salt water, extremes of temperature, direct sunlight and UV effect. They are also susceptible to wear and tear following repeated use and can in some instances suffer accidental damage during boat operations. It is therefore recommended that regular visual and functional inspection of the switch, the circuitry and the equipment being controlled is carried out by a competent qualified person on a regular basis. If any defects are noted on the switch (see next section), replacement is mandatory so as to avoid the possibility of a malfunction. It is further recommended that an item of this nature is not intended to remain in service forever. The lifespan will depend upon the weather and UV conditions to which the switch is exposed as well as the amount of use. Therefore, a service lifespan of 3 to 5 years from date of purchase can be expected, after which time it should be replaced. Shorter lifespans could be experienced and the following inspection recommendations are therefore important in ensuring continuing safe operation.

#### Inspection

The deck switch and the system it controls should be fully tested in a 'No Load' condition prior to full functional operation as per its design purpose, before every trip, activity or task. Only after the skipper has satisfied themselves of the safe and functional operations should the equipment be used.

#### **The deck switch should be inspected pre-departure or use paying particular attention to the following:**

- Ensure there is no visible damage to the switch.
- Ensure there is no noticeable wear to the switch, its housing, its button, or fixings.
- Ensure the rubber membrane over the switch is not sticky or has any deposits or residue from cleaning fluids or other prohibited materials.
- Ensure the rubber membrane over the switch does not show any signs of cracks, splits, or signs of degradation. This includes a change in colour from shiny to a matte finish.
- The main switch housing should not have any visible chips or cracks.
- The switch should have a smooth positive feel with a distinct click that can be felt at the point of operation.
- There should be no signs of water ingress on any part of the switch assembly.
- Ensure that the fixings screws and seal to the deck bulkhead or coach roof are secure, and remain effective in both securing the switch and preventing water ingress.
- The switch should not feel spongy and should not make a squelch or bubbling noise due to water ingress when depressed and operated.

**NOTE:** *If any of above points are detected during inspection, the deck switches should not be used and should be replaced.*

#### **On an annual basis the deck switch should be removed by a qualified electrical technician to carry out the following:**

- All the checks detailed in 2.0 – 2.9 of this product service update.
- Inspect the underside of the deck switch for signs of corrosion, damage, or water ingress.
- Inspect the wiring for signs of loose connections or corrosion.
- In open circuit mode "OFF" condition, the resistance should be checked for a recording on the test meter beyond measurement to confirm no electrical connection.
- In closed circuit mode "ON" condition, the resistance should be less than 3 ohms.
- If the switch shows any signs of excessive wear, degradation in its action, water ingress, or loss in its electrical resistance properties, it should be changed immediately.

## Specific Considerations for Winch Operation Manual B2303 Issue 7

### Winch Operation

Please ensure that you thoroughly understand the operation and safety requirements of the winch before commencing the installation. Only persons who are completely familiar with the controls and those who have been fully made aware of the correct use of the winch should be allowed to use it. If there is any doubt of how to install or operate this unit please seek advice from a suitably qualified engineer.

- Winches used incorrectly could cause harm to equipment or crew.
- Winches should be used with care and treated with respect.
- Sailing, like many other sports can be hazardous. Even the correct selection, maintenance and use of proper equipment cannot eliminate the potential for danger, serious injury or death.
- Lewmar winches are designed and supplied for line control in marine applications and are to be used in conjunction with appropriate clutches, cleats and other manual controls and stoppers.
- It is the unavoidable responsibility of the owner or master or other responsible party to assess the risk of any operation on the vessel.
- Under no circumstances should any self tailing winch be used in self tailing mode for any lifting operation; rather suitable and adequate manual tailing should be arranged with proper means of manually cleating or stopping the hoist.
- Every winch should be installed with adequate means of manually cleating or stopping the loaded ropes. Specific Considerations for Windlass Operation Manual 65001201 Issue 2.

### Windlass Operation

Classification Societies and Lewmar require that a vessel at anchor must have its rode held by a chain stopper or equivalent strong point at all times!

At all times it is the responsibility of the boat user to ensure that the anchor and rode are properly stowed for the prevailing sea conditions. This is particularly important with high-speed powerboats, because an anchor accidentally deploying while under way can cause considerable damage. An anchor windlass is mounted in the most exposed position on a vessel and is thus subject to severe atmospheric attack resulting in a possibility of corrosion in excess of that experienced with most other items of deck equipment. As the windlass may only be used infrequently, the risk of corrosion is further increased. It is essential that the windlass is regularly examined, operated and given any necessary maintenance.

Please ensure that you thoroughly understand the operation and safety requirements of the windlass before commencing the installation. Only persons who are completely familiar with the controls and those who have been fully made aware of the correct use of the windlass should be allowed to use it. If there is any doubt of how to install or operate this unit please seek advice from a suitably qualified engineer.

- Windlasses used incorrectly could cause harm to equipment or crew.
- Windlasses should be used with care and treated with respect.
- Sailing, like many other sports can be hazardous. Even the correct selection, maintenance and use of proper equipment cannot eliminate the potential for danger, serious injury, or death.
- Lewmar windlasses are designed and supplied for anchor control in marine applications and are not to be used in conjunction with any other use.
- It is the unavoidable responsibility of the owner or master or other responsible party to assess the risk of any operation on the vessel.

### Additional Information

Lewmar recommends the use of appropriate Personal Protective Equipment and hands free communication equipment by any person going aloft, and only then where the person going aloft is properly trained in the use of that equipment and where there remain sufficient trained and experienced personnel on deck to ensure constant observation and the continued safe conduct both of the vessel and the hoisting operation.

## Chapter 11: 296DC Diagrams

### 11.1 Thru-Hull

A	Aft Bilge Pump
B	Scupper Drains
C	Scupper Drains
D	Livewell Drain
E	Helm Floor Drain
F	Water Tank Vent
G	Head Sink Drain
H	Forward Box Drain - Port
I	Anchor Locker Drain
J	Aft Fishbox Drain
K	Holding Tank Vent
L	Forward Box Drain - Starboard
M	Forward Bilge Pump Drain

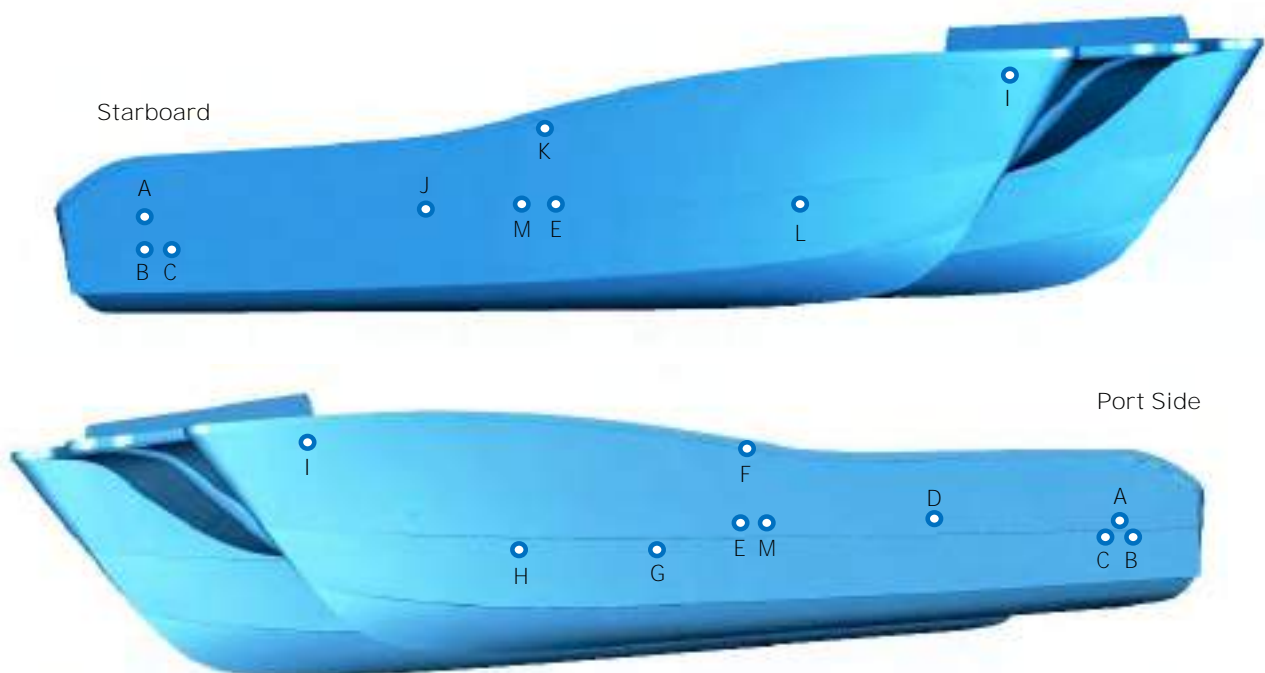



### 11.2 Freshwater System Diagram

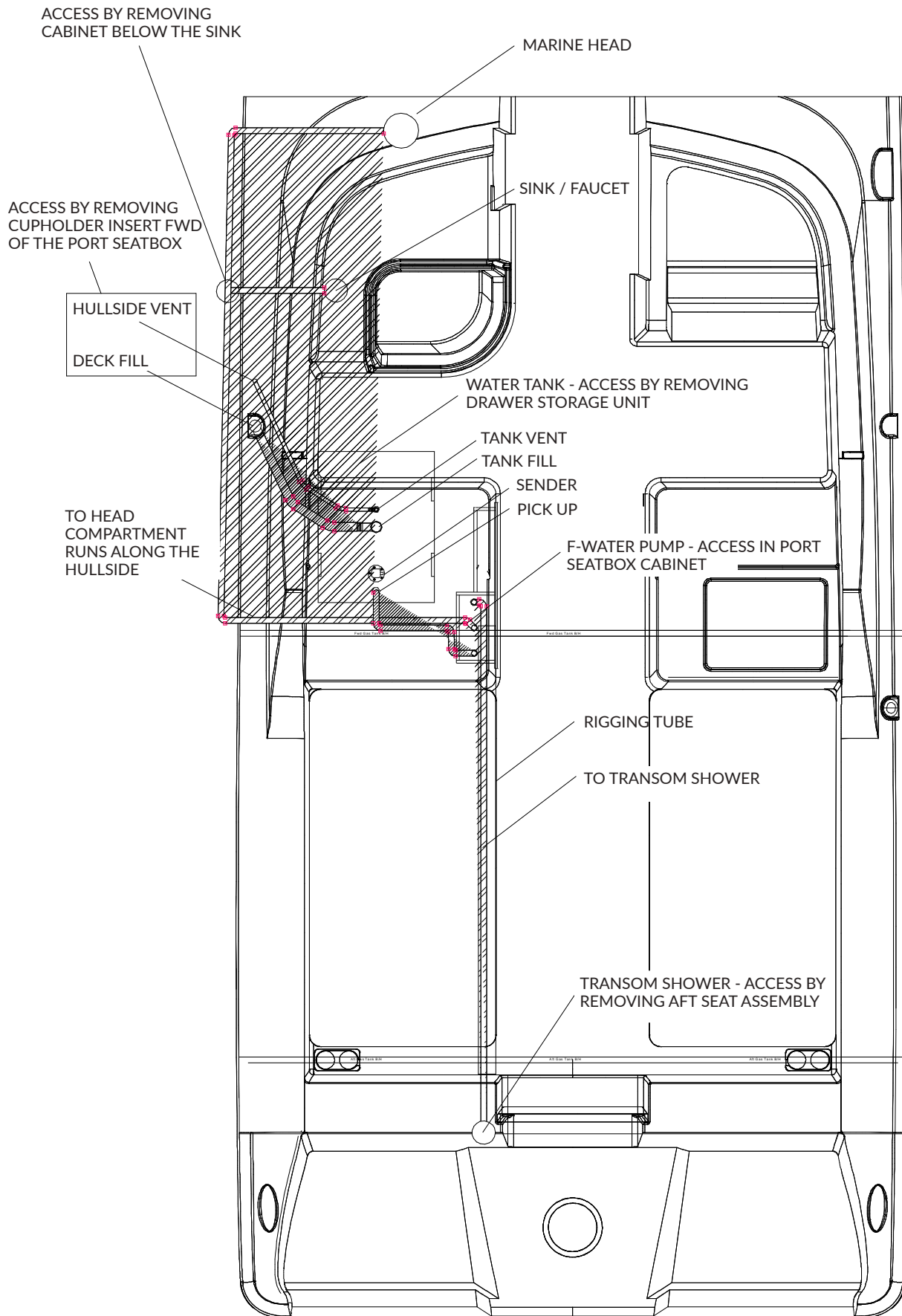



### 11.3 Livewell and Raw Water System Diagram

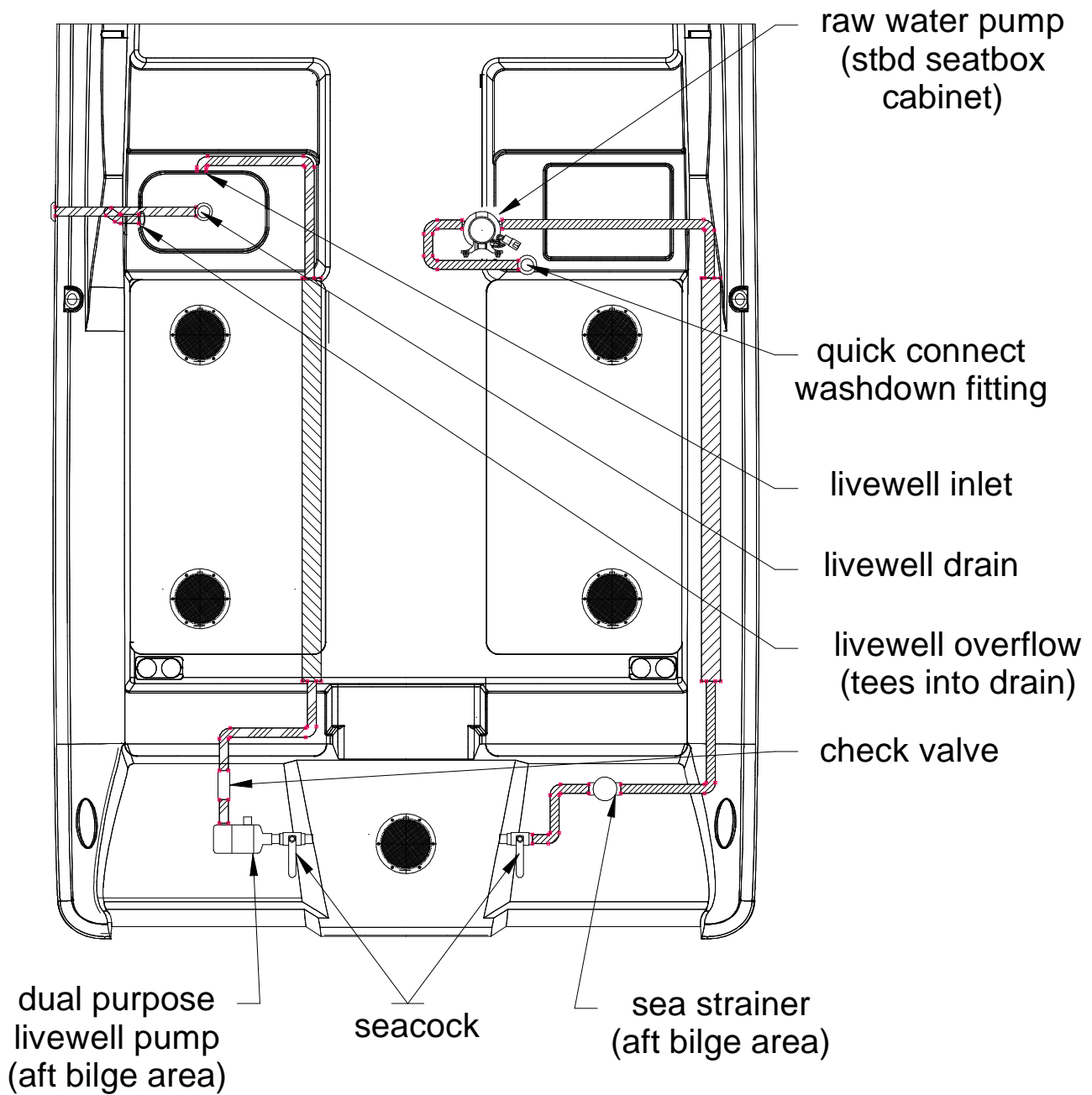

### 11.4 Marine Head Diagram

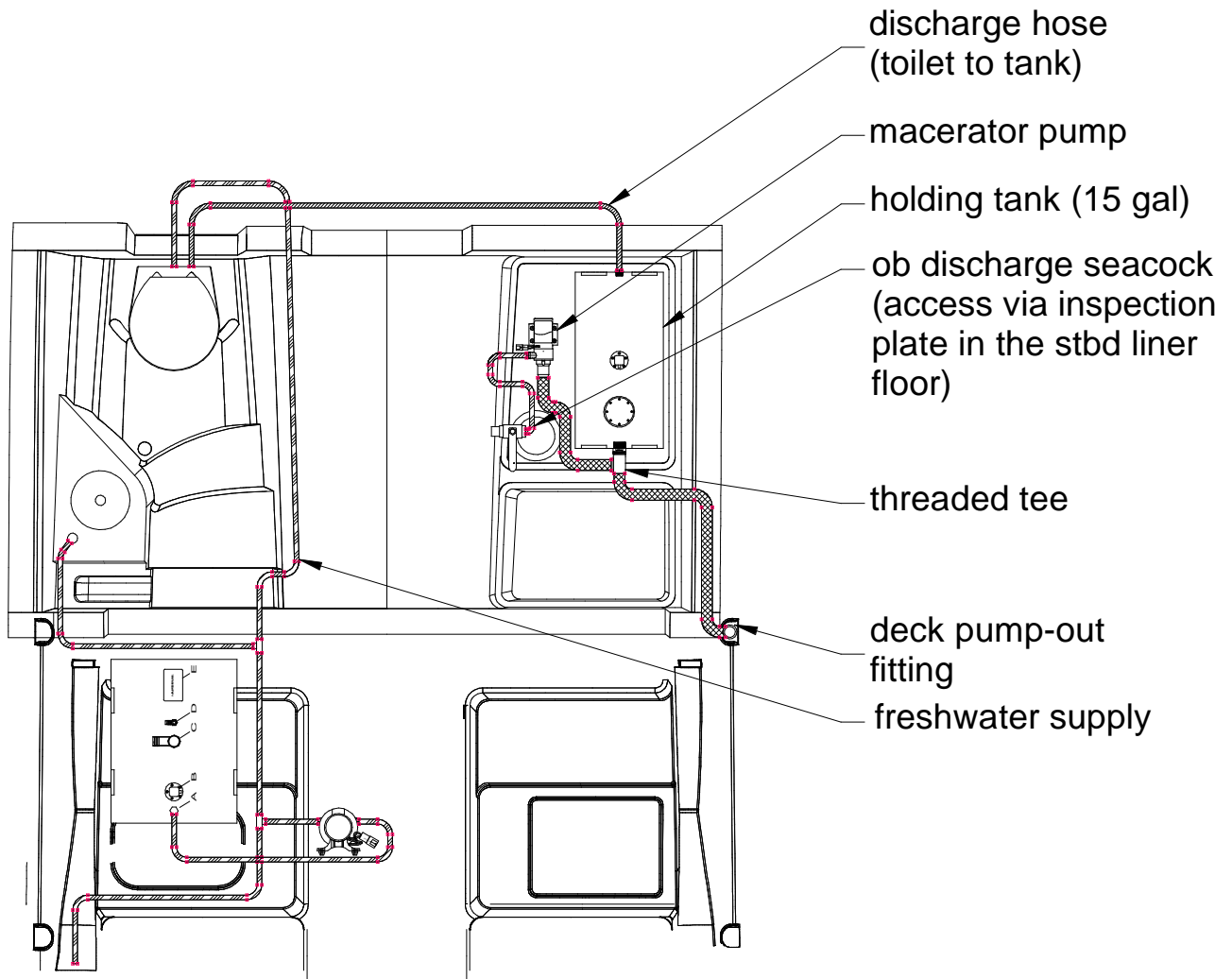

### 11.5 Port Deck Wiring Diagram

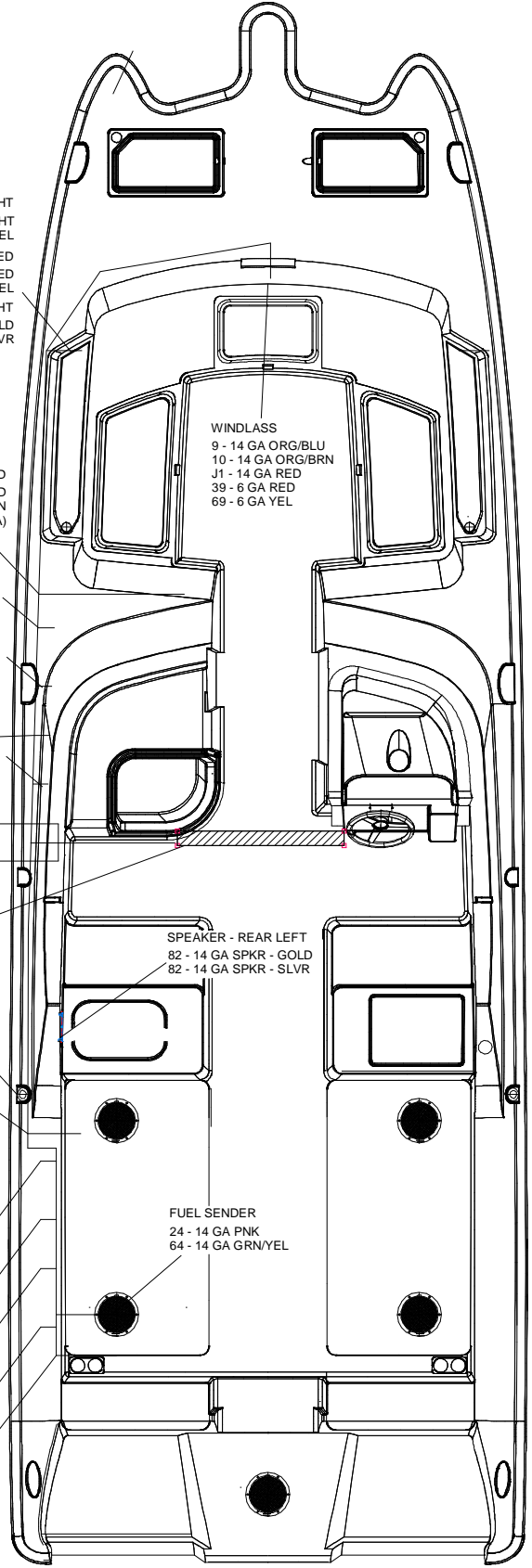
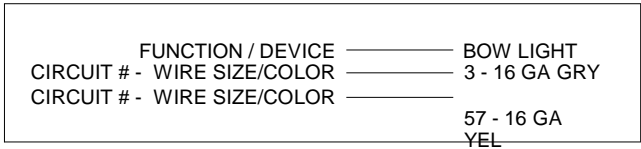

- COCKPIT LIGHT - WHT  
4 - 16 GA BLU/WHT  
64 - 16 GA YEL
- COCKPIT LIGHT - RED  
5 - 16 GA BLU/RED  
64 - 16 GA YEL
- SPEAKER - FRONT RIGHT  
80 - 14 GA SPKR - GOLD  
80 - 14 GA SPKR - SLVR

- HEAD SUB PANEL  
32 - 10 GA RED  
34 - 6 GA RED  
38 - 10 GA WHT/RED  
37 - 6 GA RED  
39 - 6 GA RED

- GROUND BUSS  
58 - 6 GA YEL  
65 - 6 GA YEL  
67 - 10 GA YEL  
69 - 6 GA YEL  
64 - 12 GA GRN/YEL  
66 - 6 GA YEL  
63 - 8 GA YEL

- MARINE HEAD  
M1 - 14 GA RED  
M2 - 14 GA BRN  
67 - 14 GA YEL (2 EA)

- WINDLASS  
9 - 14 GA ORG/BLU  
10 - 14 GA ORG/BRN  
J1 - 14 GA RED  
39 - 6 GA RED  
69 - 6 GA YEL

- HEAD LIGHTING  
49 - 16 GA RED  
66 - 16 GA YEL

- MARINE HEAD PANEL  
M1 - 14 GA RED  
M2 - 14 GA BRN  
38 - 10 GA WHT/RED  
49 - 16 GA RED  
66 - 16 GA YEL

- STEREO WIRING  
31 - 14 GA WHT/YEL  
23 - 14 GA PUR/RED  
66 - 14 GA YEL  
80 - 14 GA SPKR  
81 - 14 GA SPKR  
82 - 14 GA SPKR  
83 - 14 GA SPKR

- HEAD LIGHTING  
49 - 16 GA RED  
66 - 16 GA YEL

- HEAD LIGHTING  
49 - 14 GA RED  
40 - 14 GA BLU

- SPEAKER - REAR LEFT  
82 - 14 GA SPKR - GOLD  
82 - 14 GA SPKR - SLVR

- FUEL GROUND  
64 - 14 GA GRN/YEL

- HARDTOP  
2 - 14 GA GRY  
37 - 6 GA RED  
65 - 6 GA YEL

- COCKPIT LIGHT - RED  
5 - 16 GA BLU/RED  
63 - 16 GA YEL

- COCKPIT LIGHT - WHT  
4 - 16 GA BLU/WHT  
63 - 16 GA YEL

- COCKPIT LIGHT - RED  
5 - 16 GA BLU/RED  
63 - 16 GA YEL

- COCKPIT LIGHT - WHT  
4 - 16 GA BLU/WHT  
63 - 16 GA YEL

- COCKPIT OUTLET  
32 - 10 GA RED  
63 - 10 GA YEL

- FUEL SENDER  
24 - 14 GA PNK  
64 - 14 GA GRN/YEL

PLUG DETAIL H  
DEUTSCH DT06-8S

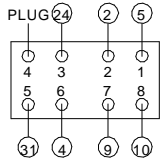

- 5 - 14 GA BLU/RED  
LABEL: C-PIT LIGHTS - 14 GA GRY
- 2 - LABEL: ANC LTS 14 GA PNK
- 24 - LABEL: PORT FUEL SENDER 14 GA ORG/BRN
- 10 - LOAD: WINDLASS UP 14 GA ORG/BLU
- 9 - LOAD: WINDLASS DOWN 14 GA BLU/WHT
- 4 - LABEL: C-PIT LIGHTS - 14 GA WHT/YEL
- 31 - LABEL: STEREO MEMORY

- 47 - 14 GA ORG/RED  
LABEL: WIPER PARK
- 19 - 14 GA ORG/BLK  
LABEL: WIPER PORT
- 58 - 6 GA YEL  
LABEL: HEAD SUB-PANEL
- 34 - 6 GA RED  
LABEL: HEAD SUB-PANEL
- 23 - 14 GA PUR/RED  
LABEL: STEREO
- 40 - 14 GA BLU  
LABEL: HEAD LIGHTING

PLUG DETAIL G  
DEUTSCH HDP 26 - 18-6 SN

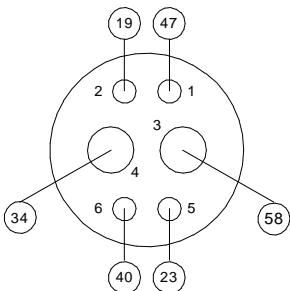

### 11.6 Starboard Deck Wiring Diagram

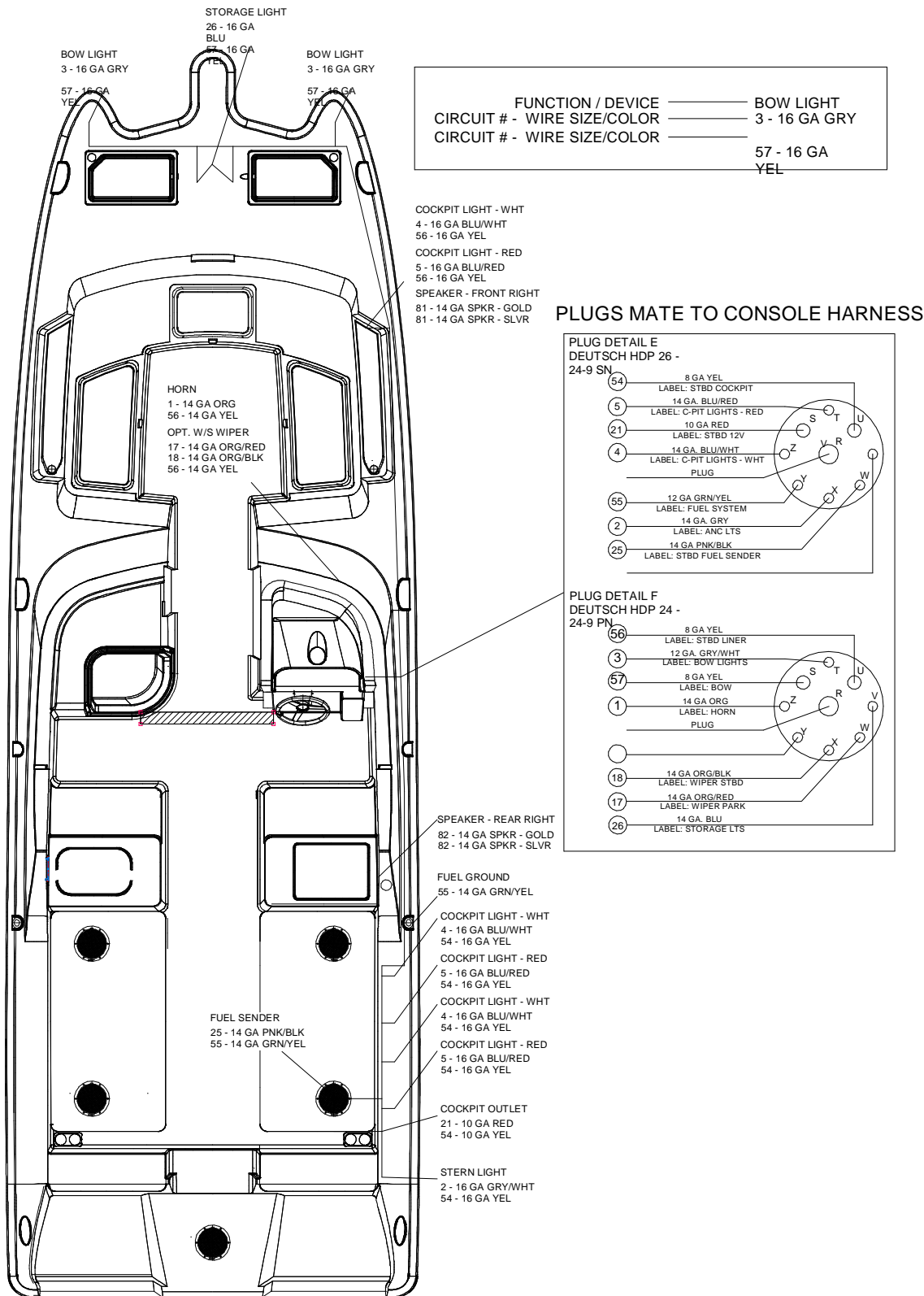

### 11.7 Battery Management Panel

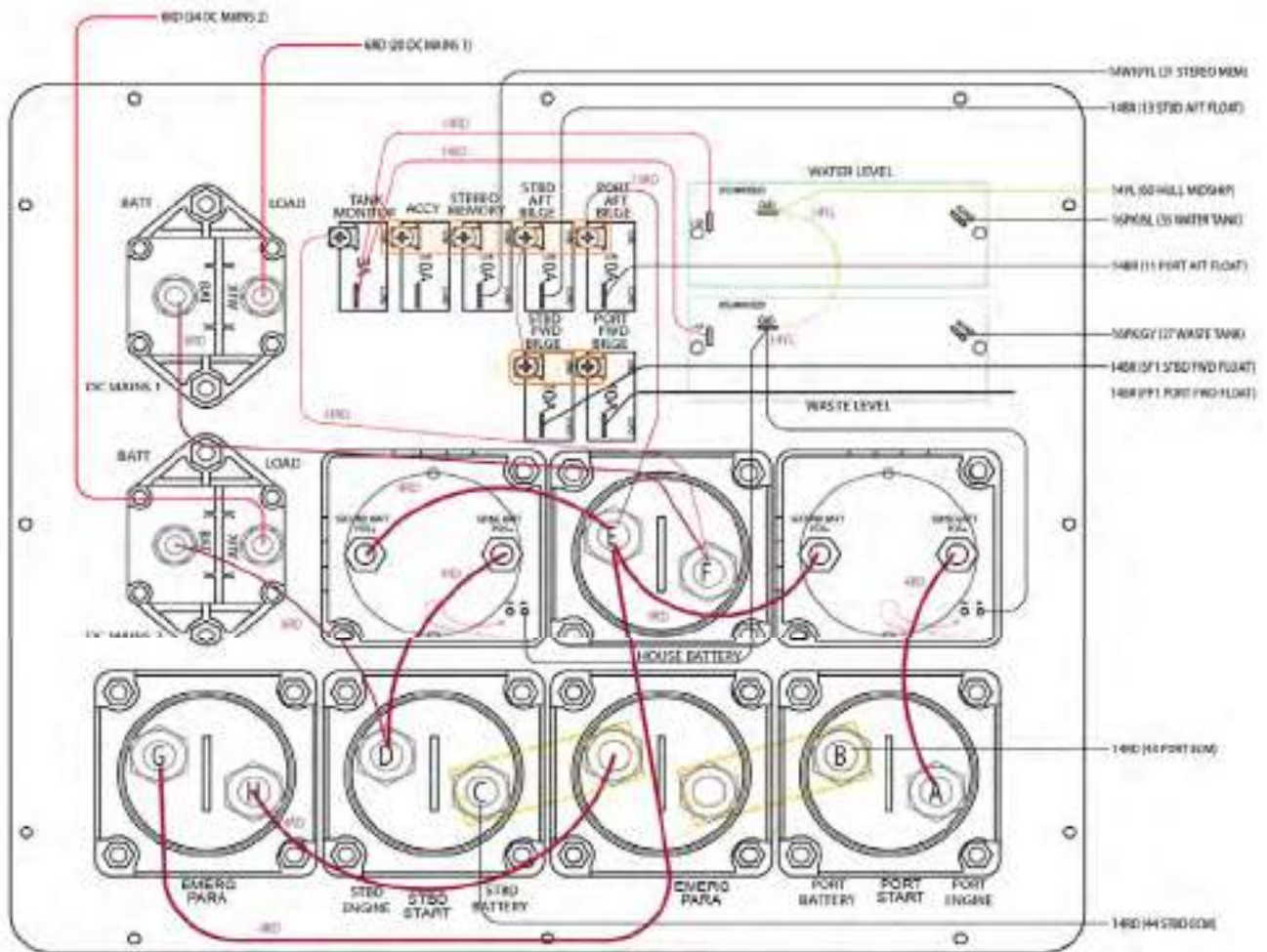



### 11.8 Switch Panel Fuses

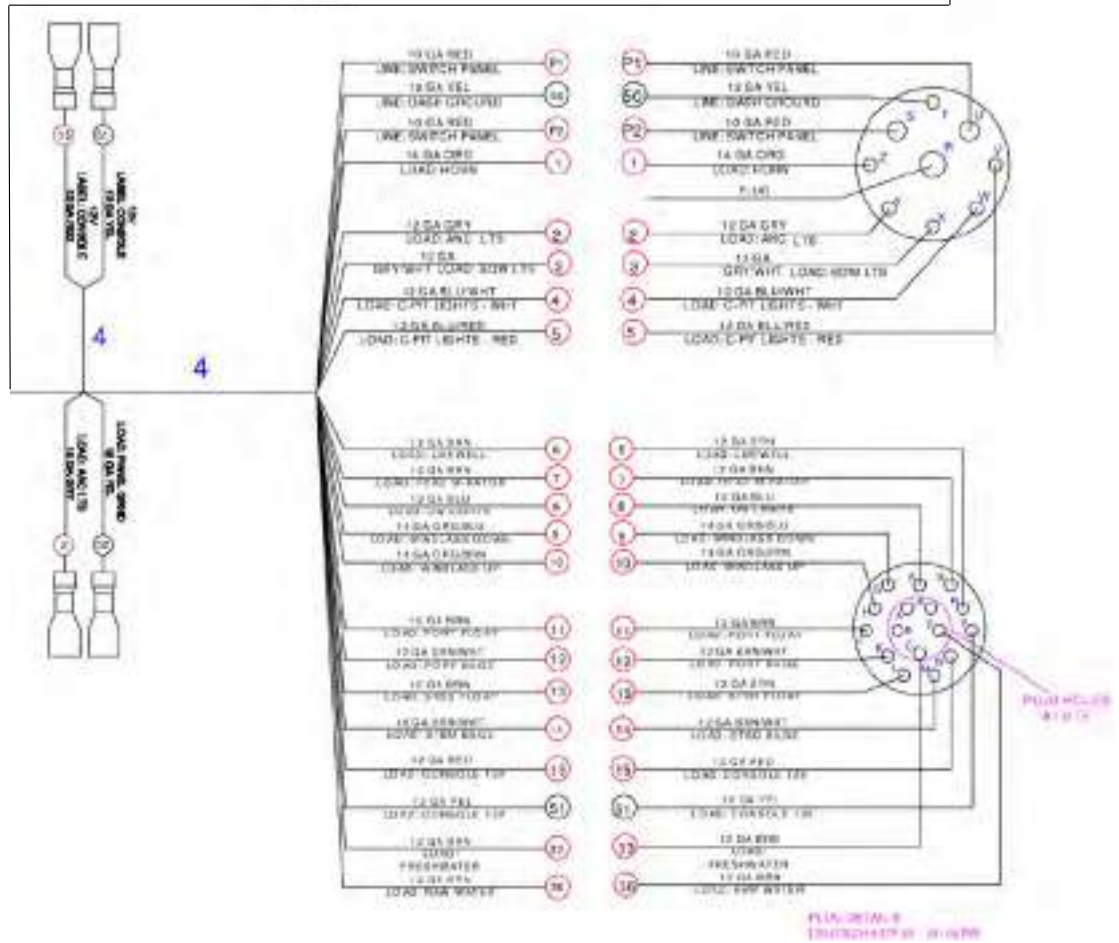
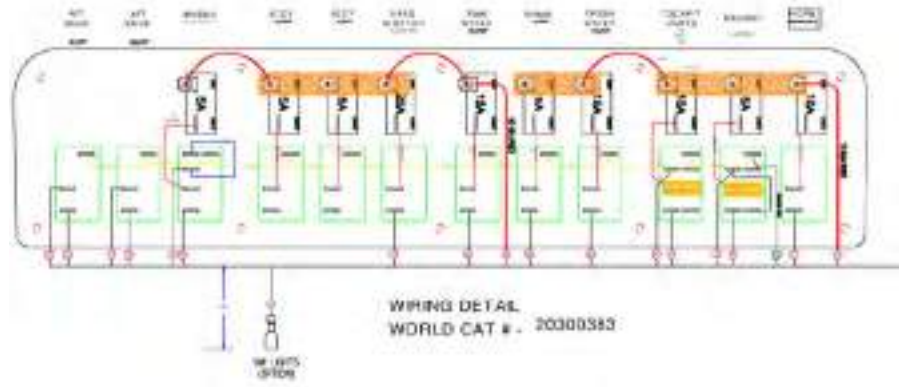
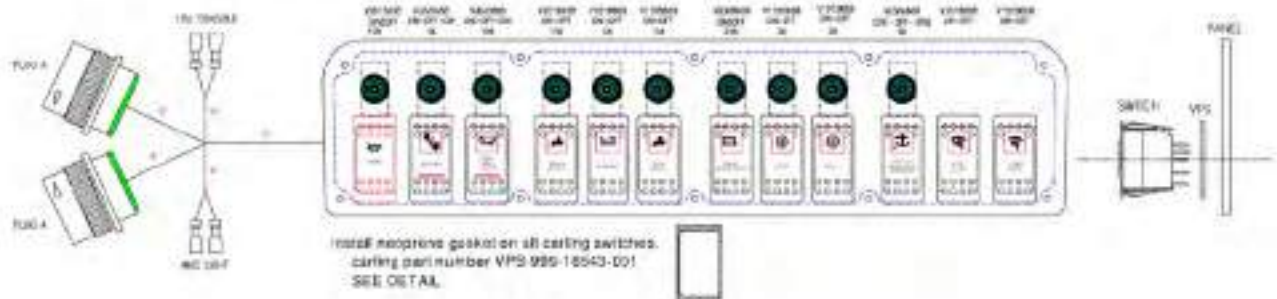

**11.9 Wire Code**

FUNCTION	COLOR	GAUGE	BREAKER / FUSE AMPS	BREAKER / FUSE LOCATION
Switch Cluster	Red	#10	30A Fuse	Dash Panel Fuse Block
Console 12V	Red	#12	30A Fuse	Dash Panel Fuse Block
Switch Cluster	Red	#10	30A Fuse	Dash Panel Fuse Block
Head Lighting	Blue	#14	5A Fuse	Dash Panel Fuse Block
Stbd C-Pit Outlet	Red	#10	20A Fuse	Dash Panel Fuse Block
Work Light	Blue	#16	5A Fuse	Dash Panel Fuse Block
Wiper System	Red	#14	10A Fuse	Dash Panel Fuse Block
Refrigerator	Red	#14	4A Fuse	Dash Panel Fuse Block
Storage Light	Blue	#14	5A Fuse	Dash Panel Fuse Block
Stereo	Purple / Red	#14	1A Fuse	Dash Panel Fuse Block
Tank Monitor	Red	#16	1A Fuse	Dash Panel Fuse Block
Horn	Orange	#14	10A Breaker	Switch Panel
Nav Lights	Grey / White	#14	5A Breaker	Switch Panel
Anchor Light	Grey	#14	5A Breaker	Switch Panel
Cockpit Lights	Blue	#14	10A Breaker	Switch Panel
Livewell Pump	Brown	#12	5A Breaker	Switch Panel
Fresh Water Pump	Brown	#12	15A Breaker	Switch Panel
Raw Water Pump	Brown	#12	15A Breaker	Switch Panel
ACCY 1	Open	N/A	5A Breaker	Switch Panel
ACCY 2	Open	N/A	5A Breaker	Switch Panel
Windlass	Red	#14	5A Breaker	Switch Panel
Head Macerator	Brown	#12	20A Breaker	Switch Panel
Winch	Red	#6	50A Breaker	Head Sub Panel
Hardtop Power	Red	#6	25A Breaker	Head Sub Panel
Head	White / Red	#10	25A Breaker	Head Sub Panel
DC Outlets	Red	#10	20A Breaker	Head Sub Panel
Stereo Memory	White / Yellow	#14	10A Breaker	Battery Management Panel
ACCY	Open	#14	10A Breaker	Battery Management Panel
Port Aft Float Switch	Brown	#14	10A Breaker	Battery Management Panel
Stbd Aft Float Switch	Brown	#14	10A Breaker	Battery Management Panel
Tank Monitor	Red	#14	3A Breaker	Battery Management Panel
DC Main 1	Red	#8	50A Breaker	Battery Management Panel
DC Main 2	Red	#8	50A Breaker	Battery Management Panel



## Chapter 12: Spare Parts List for Non-Warranty Repairs

**PLEASE NOTE: Parts / Colors / Equipment are subject to change.  
Contact your local dealer for the latest information**

Service Class	Part Number	Description
Electrical & Lighting		
	20190123	12VDC Outlet for Downriggers
	20170274	12VDC Outlet for Lighter Plug
	20190139	12VDC Receptacle Mounting Plate
	20190138	12VDC Receptacle Plug Troll MTR, Plug Bulk
	20190372	290DC Common Ground Jumper (CUSTOM)
	20300383	290DC Instrument Panel Assy (Pacer 2013MY)
	20300305	290DC Radio Box Panel Assy (REV-1)
	20171467	290DC Sub Panel (360 DC 1x1 Panel/4 Switch)
	20173484	295DC Battery Management Panel (2014MY-Pacer)
	20200297	Atwood LED Mast Light (24") - 5/5 Base
	20156841	Battery Tray (Group 27) - Narrow Width - 5/5 Rods

Service Class	Part Number	Description
	20150379	Battery Tray (Group 31) - Narrow Width - 5/5 Rods
	20170277	BEP Negative Buss Bar HD (300A/4-Pole)
	20190177	BEP Positive Stud
	20170220	Cabin Light
	20173416	Coastal Plus Wiper Motor 2 1/2" Shaft
	20151493	Day/Night (3" Rnd) White - w/Battery Backup Solar Mini-Vent
	20170335	Deka Battery (Group 31/Std)-House (DP31DT)
	20170360	Dual Direction Ctrl 12V (PM)
	20200298	Hardtop LED Light w/ Driver (P/C Bezel)
	20200283	LED Bow Lights (PR)
	20200272	LED Cockpit Light











Service Class	Part Number	Description
	20200274	LED Cockpit Light Trim Ring
	20200273	LED Livewell Light - Red
	20200273	LED Livewell Light - Red
	20200291	LED Overhead Light (2.75")
	20200292	LED Overhead Light (4")
	20200285	LED Stern Light (48")
	20200287	LED Storage Light
	20170371	Lewmar ProFish 700 Windlass - Freefall
	20170874	Lewmar Windlass Up/Down Foot Switches (Black)
	20200286	Pole Light Base, Black SS w/ Locking Collar (2-Pin Light)
	20173426	ProSport 20 Plus 3-Bank Waterproof Charger (20A, 50/60Hz 90-135VAC)

Service Class	Part Number	Description
	20150382	PSPT AC Plug Holder w/ Clamp
	20200300	Replacement Bezel - Powder Coat for part # APL-174L-501-51
	20170913	Ritchie Compass (Small Profile)
	20150888	SF/290DC Electrical Enclosure
	20200277	Spreader Light (Flush Mount)
	20200294	Storage Light Base (use w/ 20200287)
	20157087	Underwater Light (Blue LED)
	20200357	Vimar 1M Faceplate (Chrome)
	20200362	Vimar Mounting Box 3M
	20200363	Vimar Mounting Frame 1M
	20200356	Vimar On - Off Switch

Service Class	Part Number	Description
	20170911	Wiper Controls Backing Plate
	20170880	Wiper Fluid Reservoir (4 liter)
<b>Fiberglass</b>		
	20130006	Laminated Anchor Locker Lid (230SF, 250SF/DC, 290, 320)
	26000324	Laminated Deck Cap-Port (290DC)
	26000325	Laminated Deck Cap-Std (290DC)
	26003607	Laminated Deck Plate - World Cat White (8" x 10")
	26000320	Laminated Forward Seat Lid Port (290DC)
	26003608	Laminated Gas Tank Lid (P/S) (290DC EPA 2014MY)
	26000369	Laminated Head Door - Outer (290DC)
	26000251	Laminated WC White Swim Platform Floor
<b>Fuel System</b>		
	20160328	1/4 PT X 3/8 HB, Brass 90 deg.

Service Class	Part Number	Description
	20220083	Attwood FDV Fuel Demand Value (No-Antisiphon)
	20163465	Attwood Inlet Control Valve (EPA Durnal)
	20163488	Attwood Pressure Relief Deck Gas Fill (Straight Zamak/Chrome)
	20140102	Fuel Hose 1 1/2" (50'/RL)
	20140103	Fuel Hose 3/8" (250'/RL)
	20140104	Fuel Hose 5/8" (250'/RL)
	20220101	Gas Tank 125 Gal (Low Perm Pressurized)
	20220039	Tank Hold Down Brackets (Inca J-Hooks)
	90441543	Yamaha Fuel Filter/Water Separator
<b>Gel coat</b>		
	20040120	Gel Ext Ashland "Aqua Mist" (Awlgrip H4365 Match) (PL357)
	20040132	Gel Ext Ashland "Platinum" (RAL-7040 Window Gray) (PL357)













Service Class	Part Number	Description
	20040037	Gel Ext Ashland "World Cat Exterior" (164922)
	20040037	Gel Ext Ashland "World Cat Exterior" (164922)
 Sapphire Blue	20040098	Gel Ext Ashland NCP "Sapphire Blue" (RAL-5003) (PL357)
 Ice Blue	20040128	Gel Ext Ashland NRP "Ice Blue" (Sea Hunt Match) (PL357)
 Ice Blue	20040128	Gel Ext Ashland NRP "Ice Blue" (Sea Hunt Match) (PL357)
 Arctic White	20040090	Gel Int Ashland "SR Arctic White" Gel (11 Series)
<b>Graphic &amp; Logos</b>		
	20690362	Battery Management Label
	20690359	Fire Extinguisher Sticker
	60690314	Flammable Warning Decal
	20690500	Fuel Fill Warning Label
	20690436	Illegal to Dump/Trash Overboard

Service Class	Part Number	Description
	20600229	NMMA Yacht Plate (World Cat)
	20690484	PowerCat Group RTM Coverup (Crystal Cap Foam Backed, 1.5 x 2.25)
	20690361	Raw Water Sticker
	20690345	Vectorflo Graphic
	60690302	Warning Label - Prop Helm
	60690301	Warning Label - Prop Transom
	20690331	World Cat "S/S" Hullside Logo (Chrome 3.15" x 26")
<b>Hardware- Deck</b>		
	20160486	1 1/2" Painted Cap
	20150232	12" Handrail W/ Studs, S/S Part
	20700279	24" Folddown Stern Seat Frame (290's/320EC)
	20150926	290 Port Transom Cover

Service Class	Part Number	Description
	20150927	290 Stbd Transom Cover
	20610400	290 World Cat Aft Pre-Bent (Port) - Taco CRB/304 SS
	20610401	290 World Cat Aft Pre-Bent (Stbd) - Taco CRB/304 SS
	20156961	290, 320 Transom Door (ST Starboard, World Cat)
	20151036	290/320 Bow Table (Seafoam)
	20150936	290DC Battery Closeout Lid
	20160522	290DC Bow Handrail - Port
	20160523	290DC Bow Handrail - Stbd
	20151033	290DC Drawer Storage Unit
	20151033	290DC Drawer Storage Unit
	20151039	290DC Helm Footrest

Service Class	Part Number	Description
	20151047	2900C Mirror (9" x 15")
	20151110	2900C Port Countertop w/ Sink & Cutting Board - Ent Option
	20151017	2900C Rod Locker Closeout
	20150938	2900C Rod Locker Door
	20151019	2900C Rod Locker Racks
	20151022	2900C Rope Locker Cabinet
	20151108	2900C Storage Cabinet - Ent Option
	20150935	2900C Storage Liner Lid
	20151037	2900C Vanity Cabinet
	20151018	2900C Windlass Closeout
	20151013	2900C/EC Countertop Assy

Service Class	Part Number	Description
	20510943	295DC Hardtop Storage Net Tan (New Part)
	20157021	295DC Std Battery Panel Cabinet - Starboard Face (2014MY) (holds 20173484)
	20157021	295DC Std Battery Panel Cabinet - Starboard Face (2014MY) (holds 20173484)
	20157024	295DC Windshield Closeout Door (New Part)
	20160229	3" Cable Boot, Off White
	20160329	3" White Trim Ring (Chaffing Ring)
	20160231	3/8" Plastic Drain
	20160330	4" White Trim Ring (Chaffing Ring)
	20163444	4.5" Cable Boot - Black
	20160241	5" Straight Chock for Pulpit
	20163550	8" Cutting Edge sleek pull up cleat

Service Class	Part Number	Description
	20160470	Adjustable Windshield Brace (8 1/2"-10 1/2")
	20160541	Aft Seat Mounting Plates
	20210266	Aluminum Cushioned Clamps (3/4")
	20150333	Anchor Rope Special 8-Plaited Anchor Rope (2005)
	20150332	Anchor Safety Strap (2005)
	20160323	Armstrong Square Motorwell Plate (10" x 20" Rect) - Off White WC
	20163486	ASI Bracket for Gas Shocks
	20163486	ASI Bracket for Gas Shocks
	20163485	ASI S/S Flat Bracket for Gas Shocks w/LOMM
	20160269	Barrel Bolt for TE Transom Door
	20157027	Barrel Bolt Spacer (296DC Windshield Closeout Door)



Service Class	Part Number	Description
	W7010057	Bottom H Section of Seat (290's/320EC-24" Folddown Stern Seat)
	20150235	Bow Roller
	20153405	Bow Table Storage Unit 290 (Seafoam) WC
	20150501	Cabin Cockpit Floor Base Cap
	20150359	Cabin Cockpit Floor Base, 5" (for Table)
	20150360	Cabin Cockpit Table Base
	20150353	Cabin Cockpit Table Post 27"
	20140107	Clear Hose 3/8" (200'/RL)
	20150931	Cockpit Storage Unit - Port (290DC, 290CC, 290EC, 320CC)
	20150932	Cockpit Storage Unit - Stbd (290DC, 290CC, 290EC, 320CC)
	20500240	Color Match 30455 & Vinyl Bow (WC 290)

Service Class	Part Number	Description
	20160169	Drain Plate Stainless Steel Cockpit Area
	20430001	Draw Latch (Small Rubber 4.16")
	20160477	Draw Latch Keeper
	**26500443	Faucet - Single Lever/Cold H2O (2740/2770)
	26500443	Faucet - Single Lever/Cold H2O (2740/2770)
	20150937	Fire Extinguisher Cabinet - Port (290DC/320CC)
	20150939	Fire Extinguisher Cabinet - Stbd (290DC, 290CC, 320CC)
	20700311	Folding Footrest (255DC/290DC)
	20700311	Folding Footrest (255DC/290DC)
	20163466	Gas Shock 12" Ext. Length, 30lb, 316SS w/ Composite End
	20163469	Gas Shock 17" Ext. Length, 30lb, 316SS w/ Composite Ends

Service Class	Part Number	Description
	20163470	Gas Shock 7.5" Ext. Length, 20lb, 316SS w/ Composite Ends
	20163470	Gas Shock 7.5" Ext. Length, 20lb, 316SS w/ Composite Ends
	20160275	GEM S/S Lift Handle Latch Lock 3"
	20151104	Grill Mounts w/ legs (Magma Newport)
	20160703	Hinge 2" x 3" Anchor Lid Style
	20160363	Holder Magnetic Window 316SS 30 x 15 Strike
	20163472	IPS 4" Access Plate (Dream White - World Cat)
	20163473	IPS 6" Access Plate (Dream White - World Cat)
	20163474	IPS 8" Access Plate (Dream White - World Cat)
	20150311	Large Anchor 22lb
	**20163587	Latch Cam Special M10 X 1.5 Thd T316





Service Class	Part Number	Description
	20150889	Leanbar Drink Holder Insert (Offwhite)
	20160465	Lid Lock Spacer 2" Black
	20160357	Magnetic Door Holder (Proud/Flush)
	W7010083	Magnetice for E-Box Hardtop 290C/33TE
	20151103	Marine LP Grill (Magma Newport Gourmet Series)
	20100280	Mildew Resistant Silicone (Almond)
	26500438	Mirror Holder 4pc Kit w/ Screws & Anchors Hillman Number
	20160124	Neoprene .25" thick Gasket Material Cut in 2" Sections (10FT/EA)
	28130284	Outrigger Backing Plates (2/SET)
	20160488	Pedestal Base Inserts (Seafoam HDPE) Rev-1
	20160488	Pedestal Base Inserts (Seafoam HDPE) Rev-1

Service Class	Part Number	Description
	20151038	Pedestal Storage Clips
	20160121	Piano Hinge (1.75\"W/050) - 11.5\"
	20165413	Piano Hinge (2.5\" x 25.5\")
	20151111	Propane Canister Cabinet - Seafoam (Worldcat) 290DC
	20163542	Push to Close Latch, Side (Non-Magnet)
	20160343	Rigging 2\" Flange w/ Fuel Hose Port-Black
	20160344	Rigging Flange Hose Union (Black)
	20140123	Rigging Hose-Black 2\" (50'/RL)
	20150259	Rod Holder Grommet (3 3/8\")
	20150252	Rub Rail Insert - Bendable Polished 304 S/S (16' EA)
	20163509	5/8 0' Rod Holder (Cast Head, Formed Tube w/ Drain)

Service Class	Part Number	Description
	20156871	5/8 2-Step Cup Holder w/ Drain (92mm)
	20156871	5/8 2-Step Cup Holder w/ Drain (92mm)
	20163391	5/8 30° Rod Holder (Cast Head, Formed Tube w/ Drain)
	60233231	Safety Walk 12' x 60' Black (60FT/RL)
	20170254	Stainless HAM Horn
	20150292	Starboard Large Hatch (14x23) (290DC, 290CC, 320CC, 320EC, 330TE)
	20150338	Starboard Sea Foam Hatch (15 x 18 1/2) (290CC, 290DC, 290EC)
	20151028	Storage Net (16" x 24")
	20151031	Storage Net (4" x 20.5")
	20151029	Storage Net (8" x 13")
	20151012	Tackle Box Unit (290DC/290CC/320CC)











Service Class	Part Number	Description
	20160236	Thru Hull Plastic 90 1 1/2"
	20160236	Thru Hull Plastic 90 1 1/2"
	20160237	Thru Hull Plastic 90 3/4"
	20163462	Top Mount Hinge (4" x 4") (Class A)
	20150011	Transom End Cap, Nylon, Offwhite (World Cat)
	20610386	Transom Molding (Arctic White) 12' EA Thinner / No Holes
	20160353	Trim-Lok X-1088T (Lids)
	20160352	Trim-Lok X-1098T (Lids)
	20160294	Trim-Lok X-112 (Tops)
	26500436	Vitrifigo S/S Drawer DC Refrigerator
	20163559	Windshield Latch S/S 90 (Taco)
<b>Hardware- Hull</b>		



Service Class	Part Number	Description
	20690226	290/320/330 Bow Eye / 330 Stern Eye (5/8" x 4 5/8")
	20160242	8" Cleat
	20160351	Bow Eye 304SS 5/8" x 6" GLO, SS
	20150225	Drain Plug (Garboard)
	20160383	Transom Motor Plate (Lower)
	20161423	Transom Motor Plate (Upper) - No Branding
<b>Plumbing</b>		
	20160040	1 1/2" 3 Way Tee Fitting
	20160040	1 1/2" 3 Way Tee Fitting
	20160529	1 1/2" Threaded Tee
	20160512	1 1/2" Waste Pump Out
	20160510	1 1/2" Water Fill

Service Class	Part Number	Description
	20160087	1/2 PT X 3/4 HB "L",PVC Elbow 1234
	20160086	1/2 PT X 3/4 HB STR.,PVC A1234
	20160093	1/2 PT X 3/8 HB "L", EL1238
	20220036	2900C Waste Tank 15 Gal
	20220035	2900C Water Tank 33 Gal
	20160466	3 Way Reducing Tee (1 1/8" x 3/4" x 1 1/8")
	20160092	3/4 PT X 3/4 HB, PVC, A34
	20160039	3/4 x 3/4 HB Tee
	20160039	3/4 x 3/4 HB Tee
	20160127	3/4" Brass Intake w/ Nut Hi-Speed Water Pick up Bronze
	20160127	3/4" Brass Intake w/ Nut Hi-Speed Water Pick up Bronze

Service Class	Part Number	Description
	20160560	Ball Valve, Brass, 3/4"
	20160560	Ball Valve, Brass, 3/4"
	26500258	Bar Faucet (Cabin Models)
	20160388	Barbed 1-1/8" 90 Degree Aerator Head - Livewell Inlet w/ Shutoff Black
	20160388	Barbed 1-1/8" 90 Degree Aerator Head - Livewell Inlet w/ Shutoff Black
	20140100	Bilge Hose 1 1/2" (100'/RL)
	20140089	Bilge Hose 1 1/8" (100'/RL)
	20140098	Bilge Hose 3/4" (100'/RL)
	20160037	Black Strainer Impact drain 1"-1/8"
	W7010033	Bleeder Nipple-Teleflex Power Steering Pump
	W7010033	Bleeder Nipple-Teleflex Power Steering Pump

Service Class	Part Number	Description
	20160556	Deck Fill Key
	20160339	Drain, Head 320EC
	20160349	Elbow 3/8" Compression Fitting to 1/4" Male Pipe Thread
	20160094	Elbow, Faucet 3/4 H8 X 1/2 FPT
	20820440	Headhunter Inlet Strainer (3/4")
	W7013314	Impeller Kit for Shurflo Macerator Pump
	20160548	In-Line Water Filter Bracket
	20160548	In-Line Water Filter Bracket
	20150381	Jabsco Elongated Toilet Electric CE 12V
	20530464	Livewell Hose 1 1/8" Black HD PVC (100'/RL)
	20160392	Livewell Overflow Drain (Threaded Internal 1 1/2" 90)

Service Class	Part Number	Description
	20160392	Livewell Overflow Drain (Threaded Internal 1 1/2" 90)
	20740248	Macerator Pump w/ Deutsch Plug
	20160536	Nylon Elbow (3/4" MPT x 1" HB)
	20160267	Nylon Elbow 3/4" Male PT x 3/4" HB
	20161489	Nylon Female Adapter 1/2" FPTx 3/4" HB
	20161489	Nylon Female Adapter 1/2" FPTx 3/4" HB
	20160142	Plastic Elbow (3/4" 90 DEG)
	20160221	Rubber Stopper (1 1/8" PP1118)
	20740299	Rule-A-Matic Float Switch w/ Deutsch Plug
	20740298	Rule-Non Automatic Bilge pump w/ Deutsch (1500 GPH)
	20140128	Sanitation Hose 1" (100'/XL)

Service Class	Part Number	Description
	20140127	Sanitation Hose 1.5' (100'/BL)
	20163570	Screw-In 5/8 Water Inlet (2015MY)
	20740246	ShurFlo Livewell Pump w/ Deutsch (1100 GPH)
	20740246	ShurFlo Livewell Pump w/ Deutsch (1100 GPH)
	20740303	ShurFlo Pro Blaster 2 Water Pump
	20740303	ShurFlo Pro Blaster 2 Water Pump
	60233362	Sika White #2921-W High Strength Adhesive Sealer
	20160331	Stainless Sink Drain
	20160332	Stainless Sink Drain Reducer
	20820852	Strainer Mounting Bracket
	20161462	Swivel Nut Water Strainer for Washdown Pumps

Service Class	Part Number	Description
	20161462	Swivel Nut Water Strainer for Washdown Pumps
	20160355	Thru Hull Bronze 3/4"
	20160224	Thru Hull Plastic 1 1/2" w/ Scupper White
	20160218	Thru Hull Plastic 1 1/8"
	20160217	Thru Hull Plastic 3/4"
	20160219	Thru Hull Plastic 90 1 1/8"
	20163451	Thru-Hull, Resin 90° w/SS Cover, 1"
	20163452	Thru-Hull, Resin 90° w/SS Cover, 1-1/8"
	20163456	Thru-Hull, Resin w/SS Cover, 1-1/2"
	20163456	Thru-Hull, Resin w/SS Cover, 1-1/2"
	20163455	Thru-Hull, Resin w/SS Cover, 1-1/8" - 1-1/4"



Service Class	Part Number	Description
	20163454	Thru-Hull, Resin w/SS Cover, 3/4"
	20163457	Thru-Transom Scupper, Resin, w/ SS Cover, 1-1/2" (4-3/8")
	20160220	Vinyl Push Plug (1-1/2") Black
	20170878	Washer Jet (SS) - Bulkhead Mount
	20163568	Whale Twist Deck Shower Angled Base (Cold Only)
	20161447	Wingnut Adapter, 90 Nylon 3/4 HB X 1/2 NPT / for Washdown Pump
	20161447	Wingnut Adapter, 90 Nylon 3/4 HB X 1/2 NPT / for Washdown Pump
	20173467	Wiper Arm (19"-24")
	20170333	Wiper Blade (16")
	20170912	Wiper Controls Intermittent Switch
<b>Service Kits</b>		
	W7013422	Bushing, Stern Seat Black 7/8" ID X 1-1/16" OD
<b>Steering</b>		











Service Class	Part Number	Description
	20180948	12' Hydraulic Hose
	20180948	12' Hydraulic Hose
	20180949	16' Hydraulic Hose w/ BH Fitting
	W7010050	50amp Fuse Assembly (for Power Steering)
	W7010050	50amp Fuse Assembly (for Power Steering)
	20180961	6' Hydraulic Hose w/ Bulkhead
	20180961	6' Hydraulic Hose w/ Bulkhead
	20180962	8' Hydraulic Hose
	20180962	8' Hydraulic Hose
	20180017	Bracket for Steering System Valve
	20180017	Bracket for Steering System Valve

Service Class	Part Number	Description
	20180966	Gem 15" 3-Spoke S/S Steering Wheel w/ Ball Bearing Knob (w/ 1501-- 5/8" wheel nut)
	20180941	Gem Steering Wheel Nut (M12 for Uflex/Yamaha Helm Master)
	20180022	Hydraulic Tilt Helm Sea Star HH6541
	20180022	Hydraulic Tilt Helm Sea Star HH6541
	90180097	Sea Star Cylinder HC5375-3 (Hon/Suz/Yam) (2014 Cylinder)
	90180097	Sea Star Cylinder HC5375-3 (Hon/Suz/Yam) (2014 Cylinder)
	20180062	Seastar Power Assist Unit
	20180062	Seastar Power Assist Unit
	20180018	Steering Whitey Ball Valve
	20180018	Steering Whitey Ball Valve
	90410401	Suzuki LH Prop (3 x 16 x 18.5)

Service Class	Part Number	Description
	90410400	Suzuki RH Prop (3 x 16 x 18.5)
	20180034	Teleflex Hydraulic Tee
	20180034	Teleflex Hydraulic Tee
	20180031	Teleflex Hydraulic Tee (3/PK)
	20180031	Teleflex Hydraulic Tee (3/PK)
	20180094	Teleflex Power Steering Diode (Keyswitch)
	90410451	Yamaha LH Prop (3 x 15.25 x 19) SWS II SDS
	90410450	Yamaha RH Prop (3 x 15.25 x 19) SWS II SDS
<b>Upholstery</b>		
	20290941	295DC Cushion Stern Seat Backrest (Port/Stbd) (NEW PART) 3/22/2013
	20290941	295DC Cushion Stern Seat Backrest (Port/Stbd) (NEW PART) 3/22/2013
	20290942	295DC Cushion Stern Seat Base (Port/Stbd)(NEW PART) 3/22/2013

Service Class	Part Number	Description
	20290942	295DC Cushion Stern Seat Base (Port/Stbd)(NEW PART) 3/22/2013
	20290943	295DC Forward Bow Back (NEW PART) 3/22/2013
	20290943	295DC Forward Bow Back (NEW PART) 3/22/2013
	20290944	295DC Forward Bow Cushion (NEW PART) 3/22/2013
	20290944	295DC Forward Bow Cushion (NEW PART) 3/22/2013
	20290955	295DC Helm Seat Assy (Stbd) w/ Bolsters/Backrest (295DC)
	20290955	295DC Helm Seat Assy (Stbd) w/ Bolsters/Backrest (295DC)
	20290945	295DC Port Aft Bow Cushion (NEW PART) 3/22/2013
	20290945	295DC Port Aft Bow Cushion (NEW PART) 3/22/2013
	20290946	295DC Port Bow Back (NEW PART) 3/22/2013
	20290946	295DC Port Bow Back (NEW PART) 3/22/2013

Service Class	Part Number	Description
	20290947	295DC Port Cockpit Bolster (NEW PART) 3/22/2013
	20290947	295DC Port Cockpit Bolster (NEW PART) 3/22/2013
	20290956	295DC Port Forward Bow Cushion (NEW PART) 3/22/2013
	20290956	295DC Port Forward Bow Cushion (NEW PART) 3/22/2013
	20290948	295DC Port Helm Box Cushion (NEW PART) 3/22/2013
	20290948	295DC Port Helm Box Cushion (NEW PART) 3/22/2013
	20290949	295DC Port Helm Seat w/ Backrest
	20290949	295DC Port Helm Seat w/ Backrest
	20290951	295DC Starboard Aft Bow Cushion (NEW PART) 3/22/2013
	20290951	295DC Starboard Aft Bow Cushion (NEW PART) 3/22/2013
	20290952	295DC Starboard Bow Back (NEW PART) 3/22/2013

Service Class	Part Number	Description
	20290952	295DC Starboard Bow Back (NEW PART) 3/22/2013
	20290953	295DC Stbd Cockpit Bolster (NEW PART) 3/22/2013
	20290953	295DC Stbd Cockpit Bolster (NEW PART) 3/22/2013
	20290954	295DC Stbd Forward Bow Cushion (NEW PART) 3/22/2013
	20290954	295DC Stbd Forward Bow Cushion (NEW PART) 3/22/2013
	20291014	295DC Stbd Helm Box Cushion (Morbern) (NEW PART) 5/15/2013
	20291014	295DC Stbd Helm Box Cushion (Morbern) (NEW PART) 5/15/2013
	20291025	Bolster Clip 1/4" Offset (16GA 316SS)
	65040073	Fastener Stud BS10370 (1000Ew)
	65040082	Screw In Studs 3/8"









296DC

---

