

World Cat

Power Catamarans



295DC

2015 OWNER'S MANUAL

<https://www.boat-manuals.com/>



1090 WEST SAINT JAMES
TARBORO, NORTH CAROLINA 27886
PH.866/485-8899 ■ FAX 919/882-8035

Dear World Cat owner:

Thank you for being our customer. Welcome aboard!

We wish to take this opportunity to sincerely thank you for putting your trust in our boat building team and becoming the newest member of the World Cat Family.

The following manual is designed to ensure you enjoy your new World Cat for many years to come. We have made every effort to ensure you and your family are safe, enjoy the unique features of a World Cat, and continue to love the World Cat ride that no other boat company can offer.

If you should ever need assistance with the care, maintenance or operation of your boat, then please contact your World Cat dealership; they have experience with the systems and operations of your boat. If for any reason you need additional help, please feel free to contact us at the factory.

Thanks for choosing a World Cat. All of us at the factory and at your dealership are dedicated to earning your confidence.

Again, welcome aboard.

Best Regards,

World Cat

Andrew Brown
President
abrown@worldcat.com

Best Regards,

World Cat

Phyllis D. Manning
Customer Care Manager
866.485.8899 x 206
pmanning@worldcat.com

Chapter 1: Customer Information	1-6
1.1 Owner's Portfolio	1-6
1.2 Warranty Information	1-6
1.3 Dealer Responsibilities	1-6
1.4 Owner's Responsibilities	1-7
1.5 Manual Legend	1-7
!!! DANGER	1-7
!!! WARNING	1-7
!!! CAUTION	1-7
NOTICE	1-7
Chapter 2: Boat Information	2-8
Chapter 3: Boat Specifications	3-9
3.1 295DC Standard Boat Specs	3-9
3.2 295DC Features	3-10
Chapter 4: Safety and Regulations	4-11
4.1 Operator Responsibilities	4-11
4.2 Registration	4-11
4.3 Coast Guard Required Safety Equipment	4-11
NOTICE	4-11
4.4 Recommended Safety Equipment	4-11
!!! CAUTION	4-12
4.4.1 Capacity Information	4-12
4.5 Pollution Regulations	4-12
4.5.1 Oil and Hazardous Substances	4-13
4.5.2 Disposal of Plastics/Dunnage/Garbage	4-13
4.6 Boating Safety Guidelines	4-13
4.6.1 Pre-Departure	4-13
4.6.2 Launching	4-13
4.6.3 Underway: (See Chapter 5 on Performance)	4-14
4.6.4 Returning	4-14
4.7 Trailering	4-14
4.8 Anchoring	4-15
!!! CAUTION	4-15
4.9 Shallow Water	4-15
4.10 Emergency Situations	4-15
4.10.1 Emergency Stop Switch	4-15
4.10.2 Communication	4-15
4.10.3 Rendering Assistance	4-15
4.10.4 Reporting Accidents	4-16
4.10.5 Weather	4-16
4.10.6 Towing	4-16
4.11 Carbon Monoxide (CO)	4-16
!!! DANGER	4-16
Chapter 5: Performance	5-17
5.1 Overview	5-17
5.2 Motor Trim	5-17
5.2.1 Bow Up Condition	5-17
5.2.2 Bow Down Condition	5-17
5.3 Engine Controls	5-18
5.4 Steering Controls	5-18
5.5 Steering Maintenance	5-18

!!! CAUTION.....	5-18
Power Steering System Diagram.....	5-19
5.6 Power Steering System- Bleeding Instructions	5-20
NOTICE.....	5-20
5.6.1 Step 1.....	5-20
5.6.2 Step 2.....	5-20
5.6.3 Step 3.....	5-20
5.6.4 Step 4.....	5-20
5.7 Handling Characteristics.....	5-21
5.7.1 Turning Characteristics	5-21
5.7.2 Adverse Sea Conditions	5-21
5.7.3 Cross-Clutching.....	5-21
5.7.4 Get the boat on plane.....	5-21
5.7.5 Keep the boat level (if the seas change or people move on the boat).....	5-22
5.7.6 Handling different sea conditions.....	5-22
5.7.7 Boating Tips.....	5-22
5.8 Performance Factors	5-22
5.8.1 Engine Efficiency.....	5-22
5.8.2 Propeller Condition	5-22
5.8.3 Weather Conditions.....	5-23
5.8.4 Load.....	5-23
5.8.5 Marine Growth	5-23
5.8.6 Bottom Paint.....	5-23
Chapter 6: Systems Information	6-24
6.1 Overview	6-24
6.2 Fueling Guidelines.....	6-24
!!! WARNING	6-24
!!! DANGER	6-24
!!! DANGER	6-24
6.2.1 Before Fueling.....	6-24
6.2.2 During Fueling	6-24
6.2.3 After Fueling	6-24
6.3 FUEL SYSTEM	6-25
6.3.1 Fuel System Benefits.....	6-25
6.3.2 Fuel Tank	6-25
6.3.3 Fuel Vent.....	6-25
6.3.4 Fuel Distribution System.....	6-25
6.3.5 Filling Fuel Tanks	6-26
!!! WARNING	6-26
!!! WARNING	6-26
6.3.6 Pressure Relief Fuel System Diagram.....	6-26
6.3.7 Trouble Shooting Tips.....	6-27
6.3.8 Integrated Fuel Demand Valve Components	6-28
6.4 Ethanol-blended fuel	6-28
NOTICE.....	6-28
6.4.1 Additives	6-28
6.5 Electrical System.....	6-28
6.5.1 Battery System	6-29
6.5.2 Battery Distribution.....	6-29
6.5.3 Voltage Sensor Relay (VSR).....	6-30
6.5.4 Emergency Parallel	6-30
6.5.5 24 Hour Circuits	6-30

	NOTICE.....	6-30
6.5.6	Anchor Windlass	6-30
6.5.7	Windlass Deck Switch Maintenance.....	6-30
	!!! DANGER	6-30
6.6	Battery Selection	6-31
6.7	Battery Care.....	6-32
	!!! DANGER	6-32
6.7.1	Safety.....	6-32
6.7.2	Exposure.....	6-32
	!!! CAUTION.....	6-32
	!!! CAUTION.....	6-32
6.8	Wiring and Circuit Protection	6-32
6.9	Control System	6-33
	!!! CAUTION.....	6-33
	!!! CAUTION.....	6-33
6.10	Accessories	6-34
6.10.1	Navigational Lights.....	6-34
6.10.2	Cockpit Lights.....	6-34
6.10.3	Cabin / Console Lights.....	6-34
6.10.4	Spreader Lights (Standard on Hardtop).....	6-34
6.10.5	Dome Light (Standard on Hardtop).....	6-34
6.10.6	Bilge Pump / Float Switch	6-34
6.10.7	Raw Water Pump	6-34
6.10.8	Freshwater Pump.....	6-34
6.10.9	Livewell Pump	6-34
6.10.10	Macerator Pump.....	6-34
6.10.11	12v Outlets.....	6-34
6.10.12	Marine Head	6-34
6.10.13	Anchor Windlass - Freefall.....	6-35
6.10.14	Stereo (optional)	6-35
6.10.15	Windshield Wipers	6-35
6.10.16	Horn.....	6-35
6.10.17	ACC.....	6-35
6.10.18	Power steering	6-35
6.11	Gauge Packages.....	6-36
6.11.1	Yamaha™.....	6-36
6.11.2	Suzuki™.....	6-36
6.12	Plumbing System.....	6-36
Chapter 7:	Maintenance and Service.....	7-37
7.1	Overview	7-37
7.2	Gelcoat Maintenance	7-37
7.2.1	Cleaning	7-37
	!!! CAUTION.....	7-37
7.2.2	Waxing	7-37
	!!! CAUTION.....	7-37
	!!! CAUTION.....	7-38
	!!! CAUTION.....	7-38
7.2.3	Repair	7-38
	!!! WARNING	7-38
7.3	Bottom Paint.....	7-38
7.4	Upholstery	7-38
	!!! WARNING	7-38

7.5	Trim / Plexiglass / Polyethylene.....	7-39
7.6	Stainless / Aluminum.....	7-39
7.7	Powder Coating (painted) aluminum surfaces.....	7-39
7.8	Bilge Compartments.....	7-39
7.9	Cockpit Drains.....	7-39
7.10	Winterization.....	7-40
7.11	Maintenance Schedule.....	7-41
7.12	Lewmar (Provided by Lewmar).....	7-42
7.13	Maintenance Log.....	7-46
Chapter 8:	hurricane preparedness.....	8-47
Chapter 9:	2015 Warranty Policy.....	9-50
Chapter 10:	295DC Operation and Schematics.....	10-52
10.1	Operation of Standard Equipment.....	10-52
10.1.1	Battery Layout and Management.....	10-52
10.1.2	Additional Emergency Parallel.....	10-52
10.1.3	Bilge Pumps / Float Switches.....	10-52
10.1.4	Freshwater System.....	10-52
10.1.5	Seacocks.....	10-53
10.1.6	Livewell System.....	10-53
	NOTICE.....	10-53
	NOTICE.....	10-54
10.1.7	Raw Water System.....	10-54
10.1.8	Marine Head.....	10-54
	!!! WARNING.....	10-54
1.1.1.1.	Initial Start Up.....	10-54
1.1.1.2.	Normal Use.....	10-54
	!!! CAUTION.....	10-55
	!!! CAUTION.....	10-55
1.1.1.3.	Deck Pump Out.....	10-55
1.1.1.4.	Overboard Discharge.....	10-55
	!!! CAUTION.....	10-55
10.1.9	Anchor Windlass (Freefall).....	10-55
	NOTICE.....	10-55
10.1.10	Windlass Deck Switch Maintenance.....	10-56
10.2	Maximum Horsepower Rating: Twin 250 4-Stroke HP (500 HP total).....	10-56
10.3	Operation of Optional Equipment.....	10-57
10.3.1	Stereo.....	10-57
10.3.2	Outriggers.....	10-57
10.3.3	Battery Charger.....	10-57
10.4	System Diagrams.....	10-58
10.4.1	Access Plate and Rigging Tube Diagram.....	10-58
10.4.2	Wire Code.....	10-59
10.4.3	Hull Wiring Diagram.....	10-60
10.4.4	Starboard Deck Wiring Diagram.....	10-61
10.4.5	Port Deck Wiring Diagram.....	10-62
10.4.6	Freshwater System Diagram.....	10-63
10.4.7	Livewell / Raw Water System.....	10-64
10.4.8	Marine Head Diagram.....	10-65
10.4.9	Thru-Hull Diagram.....	10-66
Chapter 11:	Spare Parts List for Non-Warranty Repairs.....	11-67

Chapter 1: CUSTOMER INFORMATION

1.1 OWNER'S PORTFOLIO

To help you enjoy the many features, benefits, and accessories on your new World Cat, we have provided you with the following materials:

- World Cat Owner's Manual (model specific)
- Vendor Supplied Manuals for various accessories
- Delivery Checklist
- Warranty Information

We refer to this package as the "Owner's Portfolio", and will reference it often throughout this text. The portfolio contains a wealth of information, including advice on safety, operation, performance, maintenance, and warranty. Reading and maintaining this information is extremely important, and could be the difference between a positive and negative experience on the water.

For your convenience, World Cat also provides the NMMA text *Sportfish, Cruisers, Yachts Owner's Manual*. It will be referenced occasionally in your owner's manual, and provides supplemental information on safety and basic boating practices.

1.2 WARRANTY INFORMATION

Upon purchasing your new World Cat, the dealer is responsible for completing the warranty card provided by the factory. The Dealer is responsible for completing the warranty card and returning a copy to the factory. The Dealer should provide you with a copy to keep in a secure place so it can be referenced quickly in the event of a warranty issue. The 10 year limited hull warranty is transferable, and a copy is included at the back of this manual should you decide to sell your boat.

1.3 DEALER RESPONSIBILITIES

Our dealers are an extension of the factory, and we expect them to provide you with great customer service and help prepare you for a positive ownership experience. Therefore, we set forth a list of responsibilities for our dealers as follows:

- Provide courteous service and explanation of the product prior to the sale.
- Provide sea trials, if requested, for potential owners.
- Provide a detailed orientation of your boat's features and general operation upon delivery, including safety and performance.
- Complete and sign delivery checklist.
- Explain, complete, and submit all warranty information in a timely manner after the purchase.
- Provide the customer with the "Owner's Portfolio" and explain the information included therein.
- Provide service after the sale, or help the customer locate a qualified service at home or away.

1.4 OWNER'S RESPONSIBILITIES

As an owner you should also take an active part in the delivery and safe operation of your new catamaran. Some of your responsibilities are:

- Study and understand the limited warranty information.
- Read all literature in your "Owner's Portfolio" and operate the vessel in accordance with those instructions.
- Perform a walk through prior to the final delivery and ensure that the systems are functioning properly.
- Maintain the boat and perform service according to the instructions in this manual, including the 20 hour inspection for the vessel and engines.
- It is your responsibility to return your boat to an Authorized World Cat Dealer for warranty work.

Once your warranty information is processed, World Cat will maintain a record of your boat using the Hull Identification Number (HIN), which is located on the starboard side of the transom. Information regarding the dealership, owner, and the factory installed accessories will be recorded to help you should a problem arise. Also, you will receive an invitation to join Team World Cat and a survey to rate your purchasing experience and the initial impressions of our company. We ask that you join our family of owners and let us know your feelings about the purchase and the quality of our product.

1.5 MANUAL LEGEND

Throughout this manual you will encounter signals to alert of important information. Text printed in bold letters and the warning system shown below is of particular importance. Please review this information prior to reading the manual.

!!! DANGER

this symbol alerts you to hazards or unsafe practices which will cause extensive property damage, severe personal injury or death if the warning is ignored.

!!! WARNING

this symbol alerts you to hazards or unsafe practices which can cause extensive property damage, severe personal injury or death if the warning is ignored.

!!! CAUTION

this symbol alerts you to hazards or unsafe practices which can cause personal injury or property damage if the warning is ignored.

NOTICE

this symbol is not hazard related. it contains information on installation, operation, or maintenance which is needed to ensure the proper operation of your boat.

Chapter 2: BOAT INFORMATION

Please fill out the following information and leave in this manual for reference. This information will be important for our service personnel to provide fast and accurate service. (For service call 866-485-8899 or email service@worldcat.com.)

BOAT	
Model:	HIN:
Purchase date:	Delivery date:
Ignition Key #:	Door key #:
ENGINES	
Make:	Model:
Serial # Port:	Serial # Sbd:
Propeller Make/Model:	Propeller Diameter/Pitch:
TRAILER	
Make:	Model:
Serial # :	
DEALER	
Name:	Salesman:
Dealer Phone:	Service Manager:

Chapter 3: BOAT SPECIFICATIONS

3.1 295DC STANDARD BOAT SPECS



World Cat

DC DUAL CONSOLE

www.worldcat.com/295dc

295

SPECIFICATIONS

LOA 29'1" | Beam 9'6" | Hull Draft 15" | Freeboard Aft 27" | Transom Height 25"
Fuel Capacity 2 x 121 gal | Max HP Rating 2 x 300 hp | Approx. Dry Weight* 8,300 lbs
Trailer Height** 10'6" | Bridge Clearance 8'10" | Cockpit Length 65"
Freshwater Capacity 35 gal | Wastewater Capacity 15 gal
Typical Cruise*** 30 mph / 1.7 mpg | Typical WOT*** 48 mph / 1.1 mpg

* Includes max power and typical options
** Measured keel to top of fiberglass hard top with no outriggers nor electronics installed (not including trailer itself)
*** Tested with max power, two people, 1/2 fuel, no gear

1090 West Saint James Street, Tarboro, North Carolina 27886 | www.worldcat.com | 866.485.9899

3.2 295DC FEATURES



- Dedicated rode storage w/fiberglass chute
- Forward insulated 225-qt secondary fish box
- Large, enclosed, lockable changing area w/vanity sink and marine head
- 30-gallon re-circulating, insulated livewell
- Self-baiting cockpit
- Full 316 stainless steel hardware package (lifetime warranty)
- Spacious storage area
- Double-wide helm seat w/flip-up bolsters
- 185-qt insulated fishbox/cooler
- Euro-style transom w/heavy-duty acrylic door

FEATURES

STANDARD

- Bow**
- >> Molded-in bow pulpit with roller and cleats
 - >> Pro Series freefall windlass with 300-foot line, 15-foot chain, 22-pound anchor, and foot switches
 - >> Bow seating with cushioned backs for (6) adults
 - >> Port and starboard recessed hand-rails for added safety
 - >> (4) stainless steel cup holders and storage compartment
 - >> Lockable dry storage compartment with rod racks for (6) rods accessible from the head (Port box)
 - >> Forward insulated 225-quart fishbox with overboard drain (Starboard box)
 - >> Bi-fold weather door between the consoles to prevent wind and rain from entering the helm
- Head**
- >> Head/changing room with 23" wide access door and standing headroom
 - >> Marine head with a 15-gallon holding tank and overboard discharge
 - >> Head enclosure vanity, mirror and Corian countertop with stainless steel sink. Acrylic door has handrail and magazine rack and provides access to lockable rod locker.
- Helm**
- >> Fiberglass top with aluminum frame, radio box with flat panel to mount the VHF, overhead lights, (6) rocket launchers, spreader lights, and zipper bag for life jackets
 - >> Safety glass walk-through windshield with companion way handrails
 - >> Starboard console storage area with removable floor lids for access to (3) batteries and waste tank. Area also

- provides access to electronics and storage for the optional bow table.
 - >> Helm and passenger dual custom seats with nearby recessed stainless steel cup-holders. Helm seat has twin flip-up bolsters.
 - >> Ergonomic dash layout capable of (2) 8-inch screens or (1) 12-inch screen
 - >> Power assisted hydraulic steering system
 - >> Stainless steel wheel with power-knob
 - >> Magnetic catches on head entry and walk-through doors
 - >> Starboard seatbox with 185-quart insulated fishbox / cooler and raw-water wash down
 - >> Starboard seatbox compartments for raw-water and power-steering pumps for easy maintenance
 - >> Port seat box houses 30-gallon insulated livewell with 1100-gph magnetic drive pump, overboard drain, and a clear lid
 - >> Port seat box compartments for battery management, freshwater pump, and drawer storage
- Stern**
- >> Twin aft-facing seats on seatboxes with flip-down footrests for comfort
 - >> Port and starboard sealed fuel-filter compartments for easy maintenance
 - >> (6) pull-up stainless steel cleats
 - >> (6) gunwale-mounted stainless steel rod holders
 - >> Dual aft fold-down seats with backrest cushions
 - >> Walk-through transom with heavy-duty acrylic door, bait prep, and tool storage
 - >> Freshwater transom shower with 35-gallon water tank
 - >> Extended swim platform with integrated handrails and ladder

OPTIONAL

- Accessories**
- >> Entertainment package with drawer style refrigerator, stainless sink w/ cutting board insert, storage, and portable propane grill (no port livewell)
 - >> Pantograph-style heavy-duty waterproof windshield wiper with rinse
 - >> Removable acrylic table with dedicated storage for use in the bow or stern
- Canvas**
- >> High grade curtain package with Strataglass
- Electronics**
- >> Stereo system with (4) speakers and iPod/MP3 port
 - >> Integrated battery charging system
- 4-Stroke Engine Packages with engines, rigging, controls and props**
- >> Suzuki 250 hp / 300 hp
 - >> Yamaha 250 hp / 300 hp
 - >> Yamaha Helm Master Joystick Control
- Hull color options**
- >> Sapphire Blue, Platinum Grey, Aquamarine Green, Tanglewood Tan, Fighting Lady Yellow, or Ice Blue hull color (full hull or 2-tone)
- Outriggers**
- >> Taco 370 Grand Slam(tm) outriggers with 18" telescopic poles
- Top**
- >> Matching hardtop underside to hull side color



World Cat strives to offer the best quality & safest boats on the water. As a result, World Cat reserves the right to make changes in specifications, options, standard features, and discontinue models at any time without notice or obligation. Weight and dimensions of all models are approximate. Please contact your local dealer or the factory for additional information.

Chapter 4: SAFETY AND REGULATIONS

4.1 OPERATOR RESPONSIBILITIES

Prior to enjoying your World Cat, it is important to read and understand all the information detailed in your “Owner’s Portfolio”. Knowing how to operate and maintain the systems on your vessel can make your experiences safe and enjoyable, as well as increase the performance and longevity of your boat. Federal law and most state laws clearly indicate that it is the operator’s responsibility to maintain their vessel, and to operate it in a manner which protects the safety of their passengers and others. Reference page 10 of the *Sportfish, Cruisers, Yachts Owner’s Manual* for a detailed list of owner responsibilities.

This manual will provide you a basic understanding of boating practices; however, we recommend all owners review federal, state, and local regulations regarding safety and traffic prior to using your World Cat. The U.S. Coast Guard Auxiliary and U.S. Power Squadrons offer excellent educational opportunities on a local level and are open to anyone. If a chapter does not exist in your area, reference page 10 of the *Sportfish, Cruisers, Yachts Owner’s Manual* or contact the following numbers for other educational opportunities:

Boating Education Hotline 1-800-336-BOAT (2628)
U.S. Coast Guard Boating Hotline 1-800-368-5647

4.2 REGISTRATION

Vessels are required by federal and state law to be registered in the state where they are primarily used. Registration numbers and validation stickers must be displayed per regulations, and a certificate of registration must be on board while the vessel is being operated. When traveling away from your home waters, contact authorities at your destination to determine if any additional registration is required. Some areas require permits or temporary registrations to operate in their waters. When completing registration forms you will be asked for the Hull Identification Number (HIN). On your World Cat, the HIN is located on the starboard side of the transom. This number is unique to your boat and will be important for registering your vessel, as well as, communicating with your dealer and our service department. Including this information in any correspondence or conversations will help our support network serve you better.

4.3 COAST GUARD REQUIRED SAFETY EQUIPMENT

Once you have reviewed safe boating guidelines and filed for registration, it is time to equip your vessel. The U.S. Coast Guard’s (U.S.C.G.) list of required equipment is shown below. To review the guidelines for each item, reference pages 23 and 24 of the *Sportfish, Cruisers, Yachts Owner’s Manual*.

- Audible Signaling Device (Bell, Horn, or Whistle)
- Fire Extinguisher
- Navigation / Anchor Lights
- Flotation Devices (PFD’s)
- Visual Signaling Devices

NOTICE
Remember to check with state and local agencies to ensure that additional items are not required to operate your boat in their waterways.

4.4 RECOMMENDED SAFETY EQUIPMENT

Although not required, there are several additional items which help to ensure safety, and provide convenience for you and passengers. A list of these items can be found in the *Sportfish, Cruisers, Yachts Owner’s Manual* on page 24. Perform an annual inventory to keep tools, spare parts, and safety equipment in good condition. Immediately replace

any items that have been removed from the kit.

!!! CAUTION

Use only marine grade replacement parts. Most automotive and residential parts are not suitable for use in the harsh marine environment. Using them could lead to premature product failure, property damage, or personal injury.

4.4.1 Capacity Information

On all boats under 26 feet in length, the manufacturer is required to provide capacity information. If you own a model under 26 feet in length you will find a rectangular metal plate near the helm. This plate will provide information on horsepower ratings and total capacities which include person capacities, motor(s) and gear. As an owner you should be aware of the weight on board. Exceeding capacity can endanger your passengers and vessel, as well as void any warranty remaining on the boat should a failure occur. Remember this is a guideline for normal operation, and does not release you from responsibility should an accident occur. You must use rational judgement when adverse conditions are expected, and reduce your loads to create a margin of safety.



This label means your World Cat is certified by the NMMA. With this tag, you are assured your fuel system, electrical system, lighting, ventilation, and steering are not only in compliance with the US Coast Guard regulations, but also meet the more stringent standards of the NMMA. The NMMA is a national trade organization serving all elements of the recreational boating industry including manufacturers of boating equipment. With this tag, you can have confidence in the safety of your boat.



Pursuant to NMMA certification, all World Cats over 26' in length are "Yacht Certified" and carry the placard shown below. Person and gear capacities are not predetermined, they are left to the operator's discretion. Therefore, the amount of load allowed onboard should result from considering all safety precautions.

Horsepower ratings, however, are set by World Cat and should not be exceeded. The second page in Section 9.2 of this manual will provide information on the maximum horsepower ratings for your boat. Exceeding the factory recommendation will result in loss of warranty coverage on your vessel.

4.5 POLLUTION REGULATIONS

The Refuse Act of 1899 prohibits throwing, discharging or depositing any refuse matter of any kind (including trash, garbage, oil and other liquid pollutants) into the waters of the United States. This information is provided in a pamphlet, that normally received when registering your boat. Use the information below as a guideline, but study the pamphlet and understand any local regulations regarding pollution control. As the operator, you are also liable for individuals on your vessel disposing of materials in an improper manner.

4.5.1 Oil and Hazardous Substances

The Federal Water Pollution Control Act prohibits the discharge of oil or hazardous substances which may be harmful into U.S. navigable water. Vessels 26 feet in length and over must display a placard at least 5 by 8 inches, made of durable material. The placard must be installed in a conspicuous place in the rigging compartments or near the bilge pumps and state the following:

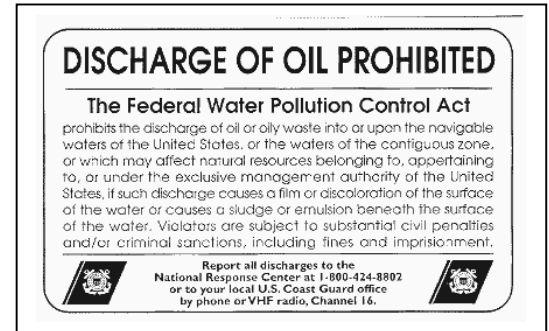

4.5.2 Disposal of Plastics/Dunnage/Garbage

Boats 26 feet in length and over must display a Save Our Seas Placard which outlines the rules for dumping waste offshore. The placards must be at least 4" x 9" and should be displayed in an area visible during normal operation. They can be purchased from your dealer or marine equipment suppliers.

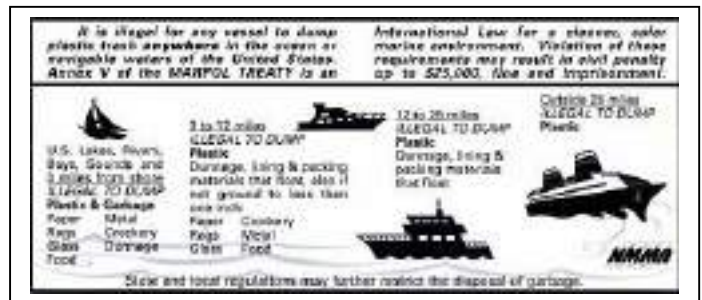

4.6 BOATING SAFETY GUIDELINES

As an owner/operator you should be prepared to handle any situation which arises before departure, while underway, or upon return to dock. Careful planning will add safety and pleasure to your experience and give you the confidence to handle emergencies if they develop. Listed below are some general guidelines which you should follow before any trip:

4.6.1 Pre-Departure

- Establish a float plan and provide it to a person whom you trust. The plan should give the details of your trip, including where you are going and when you expect to return. If you deviate from the plan, notify that person as soon as possible.
- If you anticipate operating in a new area, understand the local rules and request charts or information on any hazards you may not be aware of.
- If you are towing the boat, inspect the trailer including tires, lights, brakes, winch, and overall mechanical appearance. *Sportfish, Cruisers, Yachts Owner's Manual page 105.*
- Verify that you have all necessary safety equipment. This should include all the USCG required equipment as well as spare parts or other items you decided to include.
- Check fuel levels and determine if you require additional fuel for your trip.
- Examine the weight of the gear on your vessel and make sure you are not overloaded. Distribute the weight evenly on your vessel to ensure predictable performance.

4.6.2 Launching

- Prepare your boat prior to backing down, (i.e. secure all loose items, install garboard drain), then launch your vessel and move away quickly.
- Move your vessel away from the dock and complete a full system check. Ensure that electronics, pumps, and safety equipment are in working order.
- Instruct a passenger on the operation of the boat, and the location and function of all safety equipment onboard. You should never be the only person capable of safely operating your vessel.

4.6.3 Underway: (See Chapter 5 on Performance)

- Obey all “Rules of the Road” and any local regulations. Use the information located on page 13 of the *Sportfish, Cruisers, Yachts Owner’s Manual* to understand right of way and the various navigational and hazard indicators you will see on the water.
- **Never operate a boat under the influence of alcohol or drugs.**
- Do not allow individuals under the age of 16 to operate the vessel. Maintain direct supervision of inexperienced operators.
- Ensure that all passengers are safely seated while underway, and are using the hand rails World Cat has provided to remain securely in their seats.
- Use your electronics and judgement to remain abreast of changing weather. Storms develop quickly and you should be prepared to protect your passengers and vessel. See page 22 of the *Sportfish, Cruisers, Yachts Owner’s Manual* for more tips on weather.
- Maintain a safe speed and respect other boaters as well as those on land. Obey all “No Wake Zones” and be aware of smaller vessels. The wake you produce could endanger other crafts and their passengers.
- Know the limitations of your craft and your experience. Understand the boats handling characteristics and do not attempt to operate the vessel in conditions that are unsafe or beyond your experience level.

4.6.4 Returning

- Obey navigational markers and be aware of any tidal changes since departure.
- Collect and dispose of refuse properly to maintain our waters for future generations.
- Prepare your boat for loading before moving to the dock. Quickly pull your vessel from the water and move away from the ramp to complete the preparation for trailering.
- Verify that trailer systems are working properly and all items are secured before leaving.
- Wash the boat and perform general maintenance, upon returning home. (See instructions in Chapter 5).

As stated above, these are only general guidelines for safe boating. We recommend using these and any other available resources to protect your passengers as well as your vessel. Checklists can be an important tool in accomplishing this, see the example on pages 44 & 45 of the *Sportfish, Cruisers, Yachts Owner’s Manual*.

4.7 TRAILERING

Due to the nature of the hull, catamarans require specialized trailers. Your dealer will be able to provide them, as well as, information on safe trailering practices. Tow vehicles should be rated to handle the load and stresses which accompany trailering your boat. A properly matched trailer should carry 5-10% of the total vessel weight on the tongue. Routine inspections should be performed on the vehicle and trailer prior to each trip, and thorough checks scheduled on an annual basis.

4.8 ANCHORING

World Cat supplies an anchor and anchor windlass as standard equipment on your 295DC. The anchor we supply is known as a plow style. However, there are several types of anchors available, each designed to operate in specific bottom conditions. Your dealer can provide information on which styles are most effective in your area. See page 56 of the *Sportfish, Cruisers, Yachts Owner's Manual* for more information and tips concerning anchoring.

!!! CAUTION

Never anchor your boat off the stern. The weight at the transom, combined with adverse sea conditions could allow water to enter the boat over the transom wall.

4.9 SHALLOW WATER

Although your World Cat draws a small amount of water for its size, shallow water should be a concern of all boaters. To avoid this hazard, pay particular attention to navigational markers and know the area you are operating in. Be aware of tidal changes, including those that have occurred during your trip. Rocks, stumps, or other hazards are more prevalent in shallow water and can cause major damage to your hull bottom. Engines can also suffer damage if they are allowed to run in the sand or mud.

If you do become grounded, tilt the motors up to reduce the draft at the transom. Often this will solve the problem; however, it may be necessary to rock the boat from side to side to break the suction along the keel. If you are grounded on an incoming tide, allowing the water to rise can help. Being grounded on an outgoing tide is a larger issue, you need to act quickly to free your boat and avoid being driven further aground. Use the anchor to secure the boat and await the incoming tide, or use it to pull yourself free.

4.10 EMERGENCY SITUATIONS

Unfortunately, even the safest boating practices cannot eliminate the potential of emergency situations developing. Therefore you should prepare yourself, and your crew, to handle any problems that may arise. Establish specific plans for fires, man overboard, collision, etc., and review them with your passengers prior to departing. Planning allows people to remain calm, and gives everyone the confidence to resolve the problem. Section 4 of the *Sportfish, Cruisers, Yachts Owner's Manual* provides information on emergency procedures. Below is important information which all owners should be aware.

4.10.1 Emergency Stop Switch

Lanyard clips are provided on all World Cats and when used properly provide an emergency stop for the engines should the driver fall from the helm position, or need to perform an emergency shutdown to respond to or avoid an accident. The clip attaches the driver to the ignition panel using a cord. A pull on the cord will release the clip from the shut-off switch on the panel and shutdown the engines. To restart the engines, turn ignition switches to the off position, return binnacle to neutral position insert safety lanyard back into clip and then turn ignition switches back on. This should only be used to prevent or react to accidents, and the operator is solely responsible for the decision.

4.10.2 Communication

If you witness an emergency or become involved in one, you should request assistance via radio communication or visual signals. Review the information in Section 4 of the *Sportfish, Cruisers, Yachts Owner's Manual* for detailed information on how and when to request assistance.

4.10.3 Rendering Assistance

Owners are required by law to render assistance to other boaters involved in an emergency situation such as fire, collision, casualty, etc., as long as it does not endanger your vessel or its passengers.

4.10.4 Reporting Accidents

Federal regulations require that operators involved in an accident file a written account of the situation within 48 hours. Reports should be submitted to the State Boating Law Administrator. You can obtain forms through the USCG or local authorities (i.e. harbor patrol, sheriff or police offices). In the event that a casualty or disappearance occurs as the result of an accident, you must notify the authorities immediately by phone or radio and fill out a written statement.

4.10.5 Weather

Pay attention to weather patterns. If you find yourself in the path of a storm, seek shelter immediately. If you cannot reach a dock, seek refuge inside the boat while the storm advances. Never get in the water, and stay clear of metal components on your boat. If lightning strikes, it would likely pass through metal objects seeking a ground.

4.10.6 Towing

Due to an accident or loss of power, it may become necessary to tow another vessel or have your boat towed. If you are providing assistance, never attempt to tow a boat larger than your own. Be certain to use proper lines (ropes) and rational judgement to prevent further damage. Tow lines are under heavy strain, therefore passengers should remain clear of the lines to protect themselves from injury. For more information on towing, reference page 39 of the *Sportfish, Cruisers, Yachts Owner's Manual*.

4.11 CARBON MONOXIDE (CO)

!!! DANGER

Carbon Monoxide (CO) is a colorless, odorless, and tasteless gas produced by the exhaust system of any combustible engine. CO can cause brain damage or death, if inhaled over an extended period of time. To protect yourself and your passengers, never block the ventilation outlets in cabins, consoles, or other enclosed spaces.

One of the most important considerations when dealing with boating safety is carbon monoxide. Commonly referred to as (CO), carbon monoxide is a colorless, odorless, and tasteless gas emitted from any engine exhaust. Including inboards and outboards. A CO particle is close in weight to the air we consume; therefore it does not rise or fall in the atmosphere, but accumulates in enclosed spaces. Boat owners with enclosed heads, cabins, or canvas enclosures should pay particular attention to CO. Be aware that fumes produced on your boat can affect other vessels and other boats can affect you. A primary concern is the use of generators when boats are moored adjacent to each other.

Carbon Monoxide is poisonous and potentially fatal if inhaled over an extended period of time. Symptoms of CO poisoning include:

- Dizziness
- Nausea / Vomiting
- Headache / Throbbing in the temples
- Fatigue
- Muscular twitching
- Inability to focus or think clearly

If you or any of passengers experience any of these symptoms, leave the area and find a source of fresh air immediately. If your symptoms persist, seek medical attention.

Chapter 5: PERFORMANCE

5.1 OVERVIEW

This chapter will provide information on the performance characteristics of your catamaran; This is not a substitute for seamanship training or hands-on experience. First time boat owners should use the resources detailed in Chapter 1 to learn proper methods of boat operation. Experienced boaters who have never owned a catamaran, should study this chapter completely. Do not assume that previous boating experience will apply to all situations, as there are several subtle differences in the handling characteristics of twin hulled boats. For existing catamaran owners, this chapter should be a reference.

5.2 MOTOR TRIM

The smooth riding characteristics of a catamaran are a result of the twin hull design. Their ability to slice through oncoming waves is far superior to the slamming characteristics seen on conventional vessels. Motor trim plays an integral part in how your catamaran accomplishes this. In a level or bow down attitude, your boat will slice through larger chop but you may experience sluggish performance, a wetter ride and increased bow steering in a following sea. In a bow up attitude the boat will perform better, but may ride less smoothly. Experiment with the trim settings in various sea conditions to determine what you are most comfortable with. When using the trim to correct a listing condition, imagine an “X” connecting the starboard engine to the port bow, and port engine to the starboard bow (see drawing below).

5.2.1 Bow Up Condition

To correct a bow up condition on the port sponson, adjust the motor trim “down” on the starboard engine. This will help the starboard sponson to rise and level the vessel. If moving to the lowest trim setting on the starboard engine does not correct the list, trim the port engine “up” to assist the change. Reverse the instructions to accommodate for a bow up condition on the starboard sponson.

5.2.2 Bow Down Condition

To correct a bow down condition on the port sponson, adjust the motor trim “up” on the starboard engine. This will help the starboard sponson to fall and level the vessel. If cavitation occurs on the starboard engine, lower it to correct the problem, then trim the port engine “down” to assist the change. Reverse the instructions to accommodate for a bow down condition on the starboard sponson.

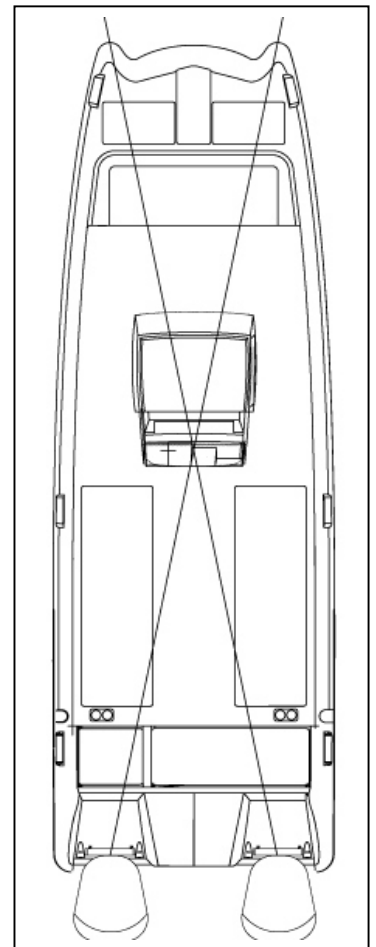

5.3 ENGINE CONTROLS

All factory rigged boats will come equipped with a binnacle control specific to your type of engine. Located at the helm, the binnacle controls the throttle, shift, and trim mechanisms for your engine. For diagrams and general information about this system, review pages 80 thru 83 of the *Sportfish, Cruisers, Yachts Owner's Manual*. Also read the owner's manual provided by your engine manufacturer to determine how to operate the features on your binnacle. If any components of this system need to be replaced, be certain to use the same style and length as the original equipment.

5.4 STEERING CONTROLS

Catamarans offer unsurpassed steering control. The wide spacing of the engines, advanced steering components, and handling characteristics of the World Cat hull give operators exceptional maneuverability in even the tightest spaces.

Because of the superior tracking abilities of the World Cat hull, oversteering can present a problem, especially for owners accustomed to operating conventional boats. Conventional vessels have a tendency to lose tracking abilities in rough and following sea conditions, making constant course corrections necessary. However, catamarans do not exhibit those traits and require operators to take a "hands off" approach. To do so, relax your grip and fight the urge to make constant corrections.

5.5 STEERING MAINTENANCE

The design of a catamaran hull requires a special steering system which features a "liquid tie-bar", as opposed to the mechanical version used in conventional boats. For this reason, your World Cat is equipped with a hydraulic steering system, featuring steering cylinders mounted on each engine and a steering system valve. This system enables both engines to respond in unison to adjustments at the helm.

In order to maintain the excellent steering characteristics of your boat, occasionally you will need to adjust the steering system to realign the motors (known as motor toe). To do so follow these instructions:

1. Using the helm, center the starboard motor.
2. Find the steering system valve, located under the inspection port on the center of the transom.
3. Open the valve by rotating it 90 degrees (the handle will be parallel to the valve body when open). This will isolate the port engine, so that it can be adjusted manually.
4. Center the port motor manually; then close the steering system ball valve and reinstall the inspection port.

Similar to hydraulic braking systems in an automobile, it may become necessary to bleed the steering system occasionally to remove air from the lines. We have provided diagrams of the steering system in section 5.6 thru 5.9, and the Teleflex™ owner's manual in your "Owner's Portfolio". Use the resources, and your dealer, to keep the steering system in excellent working order. Be aware, these are routine maintenance procedures and are not covered under warranty by World Cat.

!!! CAUTION
Routinely check hydraulic fluid levels, and all connections for leaks or any sign of mechanical failure. Lubricate all mechanical parts at least annually with high quality marine grease. Failure to do so may result in impaired or unresponsive steering.

POWER STEERING SYSTEM DIAGRAM

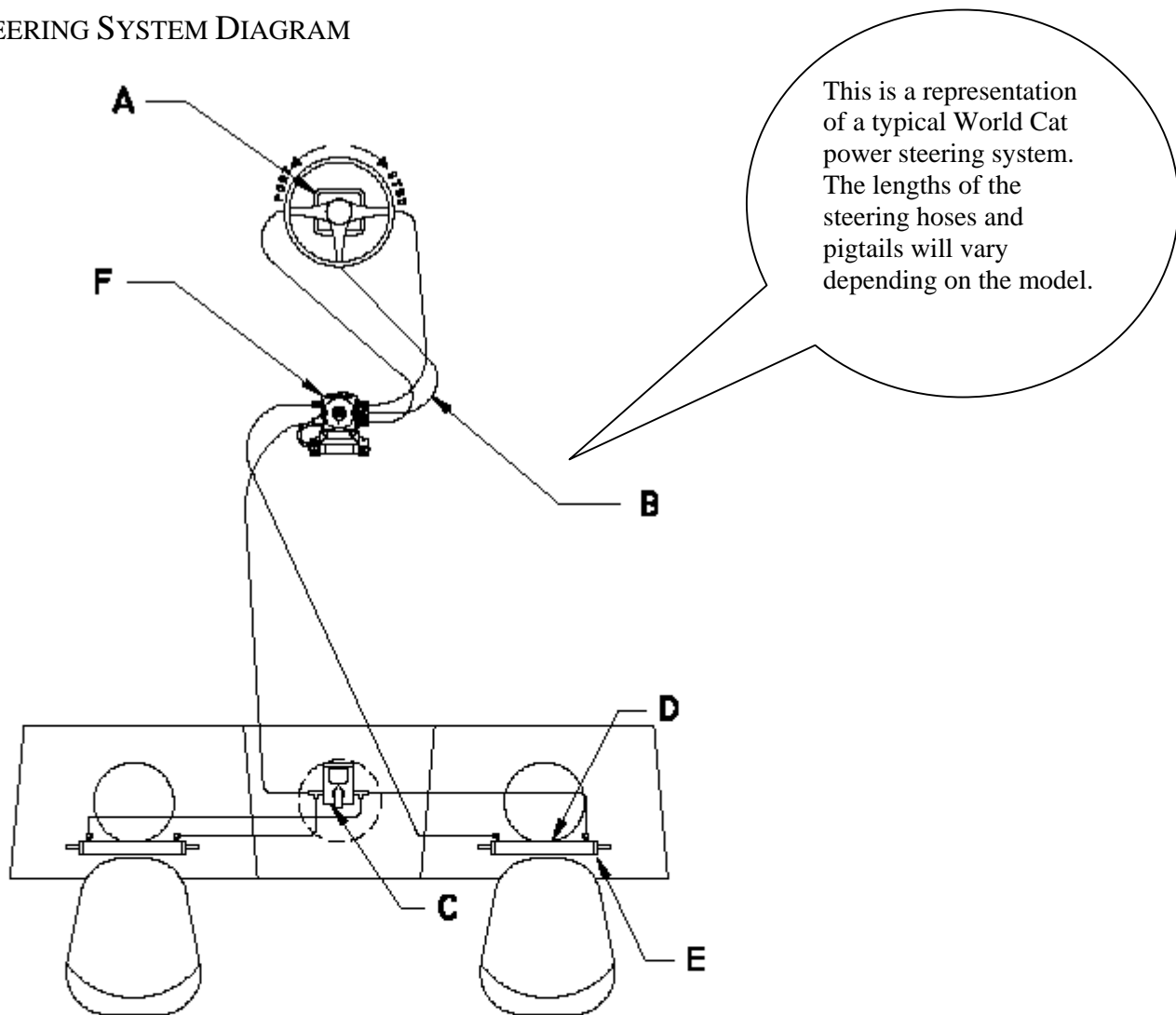

<u>ITEM</u>	<u>DESCRIPTION</u>	<u>QUANTITY</u>
A	SEA STAR II HELM	1
B	KEVLAR STEERING HOSE	2
C	STEERING SYSTEM VALVE	1
D	KEVLAR PIGTAIL 4'-6'	3
E	STEERING CYLINDERS	2
F	TELEFLEX POWER STEERING PUMP	1

5.6 POWER STEERING SYSTEM- BLEEDING INSTRUCTIONS

Reference the bleeding instructions provided by the Teleflex™ owner's manual, which is included in your "Owner's Portfolio". Use them in conjunction with the instructions and diagram below to bleed the steering system. This should be done annually.

NOTICE

If possible, have your dealer or trained marine technician perform routine maintenance or repairs on your steering system. Replace faulty parts immediately.

5.6.1 Step 1

- With the Power Purge turned "OFF", attach helm fitting and leads.
- Attach one of the leads to the bleeder valve on the Power Assist Pump.
- Open the bleeder valve using a 5/8" wrench.
- Turn the Power Purge unit "ON".
- Watch for air bubbles in the clear hydraulic lines. Once no more bubbles can be seen and there is a steady flow of hydraulic fluid through the lines, allow the Power Purge to run for an additional 60 seconds.
- The helm is now full of fluid. Turn Power Purge "OFF". Close bleeder valve and disconnect line from the Power Assist Pump. Place dust cap back on bleeder valve.

5.6.2 Step 2

- Attach the four lines to each of the bleeder valves on the steering cylinders.
- Open each of the four bleeder valves.
- Turn Power Purge "ON".
- Turn the steering wheel slowly 20 times clockwise, then slowly 20 times counter-clockwise.

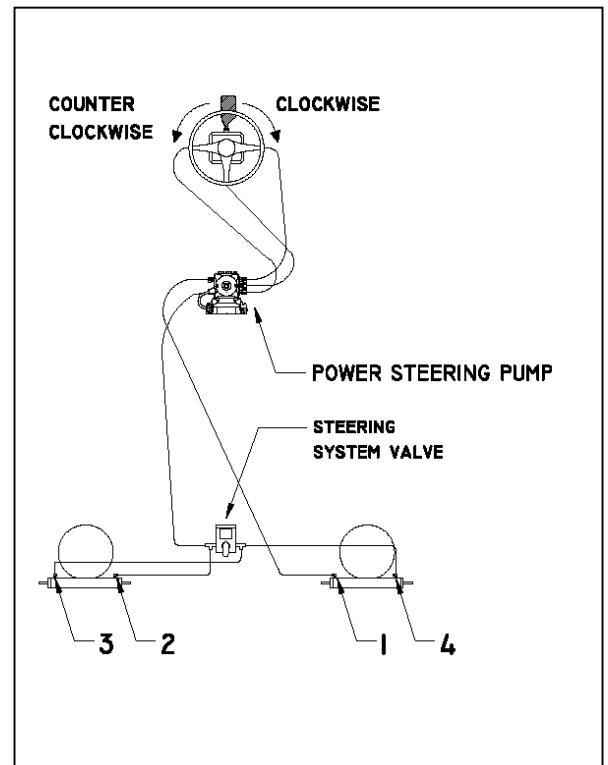

5.6.3 Step 3

- With Power Purge turned "ON", move both engines through their full range of motion (This will help remove any air bubbles still trapped inside the cylinders).
- As a final precautionary step, pull on the engines firmly at the ends of their normal range of motion (This will also help to insure all of the air is out of the cylinders).

5.6.4 Step 4

- Turn the ignition key for the port engine "ON". This will turn the Power Assist Pump "ON".
- Repeat "Step 2".
- If no more bubbles can be seen then the bleeding is complete. Turn the Power Purge "OFF". Close all four bleeder valves. Disconnect the four lines from the cylinders and both lines from the helm. Remove the helm fitting and replace it with vent cap.
- If bubbles are still present in lines, then bleeding was not successful. Repeat entire process.

5.7 HANDLING CHARACTERISTICS

World Cat's patented Vectroflo™ hull is a semi-displacement hull, which exhibits characteristics of both planing and displacement hulls. Planing hulls provide speed and economy of operation since a limited amount of the hull is in contact with the water. However, they feature flat sections along the chine which can result in poor handling at low speeds and harder impacts at high speed. Displacement hulls provide superior handling characteristics, even at low speed, and an improved ride in rough water. Speed and economy suffer however, since more of the hull is submerged. World Cat has taken the best characteristics of these two designs and incorporated them in the Vectroflo™ hull. Our proven design provides a superior ride, excellent handling characteristics in a variety of conditions, and speed with economy of operation. To help you experience "The Ultimate Ride", study the following sections.

5.7.1 Turning Characteristics

Turning a catamaran is slightly different than cornering on a conventional vessel. Imagine the difference between an automobile and a motorcycle. Automobiles take turns in a flatter, more stable, manner similar to catamarans hulls, while motorcycles pitch hard into a turn similar to a monohull. Do not underestimate a catamaran's cornering ability however, hard adjustments to the steering wheel can make a World Cat bite quickly and execute high performance turns. Experiment with the handling ability of your cat so you are prepared for any situation on the water.

5.7.2 Adverse Sea Conditions

Catamarans are designed to handle some of the roughest waters in the world, but that is no substitute for common sense. As an operator you are responsible for the safety of your passengers and vessel; therefore, your trips should be limited by your level of experience. Planning and paying constant attention to the weather and sea conditions is paramount. If you are forced to operate in dangerous seas however, you can be confident that your World Cat, when operated properly, can handle them safely. Following are some tips on how to handle your boat in adverse sea conditions:

- When traveling into the wind, changing your direction a few degrees to allow one sponson to settle before the other, can make the ride smoother and allow for increased speed.
- In a rough chop with short wave intervals, increasing your speed may allow the boat to skim across the tops of each wave. This will result in a smoother ride.
- Steer to avoid larger swells and breaking waves.
- In a following sea, position your vessel on the back of a wave and match its speed to remain ahead of the trough. Speed is paramount. Work the throttle to avoid going over the wave or being thrown down the face of a following wave.

5.7.3 Cross-Clutching

- World Cat's have their twin engines mounted 67 inches apart.
- This allows you to cross-clutch (one motor in forward while one in reverse)
- To dock, reverse the boat into a slip: put the outside motor in reverse and turn to face aft. Keeping the wheel straight, steer with the inside motor putting it in forward and reverse to guide you into the slip.
- Keep it simple and slow

5.7.4 Get the boat on plane

- Trim both engines down or in (the motors act as trim tabs forcing the bow down)
- Big advantage operating in shallow water (12" to 16" depending on the model)
- Quickly increase speed to get the boat on plane then slow down to 3500 RPM's
- Adjust trim out until the motors cavitate then tap trim in
- Feel/hear the motors and do not watch the trim gauges
- A smooth ride is more important than having your engine RPM's synchronized

5.7.5 Keep the boat level (if the seas change or people move on the boat)

- Trim the **High-Side-High**. When one side of the bow is high compared to the horizon, simply trim the high side motor up or out. (If it cavitates then trim the **low-side-low**)
- Different models have different sensitivity to trim (do not over-correct as this may cause the boat to pitch in flat calm water at high speeds)

5.7.6 Handling different sea conditions

Head sea: trim motors in to keep the bow down

Following sea: trim out to keep the bow out of the water

Calm water: trim engines up to run on the back of the hull

5.7.7 Boating Tips

Experience is the best way to determine the handling characteristics of your catamaran. Operating the boat in multiple sea conditions and under various loads will help you predict how the boat will perform in any situation. World Cat provides the following recommendations regarding the performance of your catamaran:

- Establish an RPM chart which details the speed and fuel consumption at various RPM levels to achieve the most economical operation.
- Monitor fuel gauges to determine the amount of operating time remaining at a given reading.
- Determine minimum speed for effective steering in close quarters.
- Determine the turning radius required at various speeds.
- Determine the rates of acceleration and deceleration with various load conditions. Include the distance required to stop the boat at various speeds.

Use the information provided in section 6 of the *Sportfish, Cruisers, Yachts Owner's Manual* for more information on boat handling.

5.8 PERFORMANCE FACTORS

Proper setup and maintenance of the systems on your boat is important to ensuring proper performance, but be aware they are not the only factors which affect it. Several things which contribute to the level of performance of your catamaran can change between or during trips.

5.8.1 Engine Efficiency

Without proper maintenance, your engine(s) will gradually lose power, resulting in a loss of speed. Use the recommendations in the engine's owners manual to schedule routine maintenance procedures and as a guide for the correct RPM range for your engines. Neglecting to do so may result in loss of performance and an increased risk of failure.

5.8.2 Propeller Condition

The size and condition of your prop also plays a major role in the performance of your catamaran. A damaged prop can result in lower speeds, sudden drops in RPM, increased fuel consumption, and severe vibration while running. Improperly sized props can cause damage to your engine as a result of exceeding the maximum or minimum RPM levels.

5.8.3 Weather Conditions

Barometric pressure and humidity can affect the output of your engines. For example, on an extremely hot and humid day, your engine can experience as much as a 10 percent loss in horsepower. Although you should monitor your engines' performance, be aware that the weather could be a major factor in your boats performance.

5.8.4 Load

Increased load can obviously affect performance, especially if the load is unbalanced. Passengers, gear, and fuel are all examples of things which can affect your vessel. Fuel levels change through the day, and greatly affect the attitude of your boat. When necessary, make adjustments to engine trim and load distribution to compensate for fuel usage.

5.8.5 Marine Growth

If you store your boat in the water or fail to clean it after each trip, the existence of marine growth can contribute to a loss of performance. A decline in speed or increased fuel consumption can occur. Prevent this by applying a marine growth inhibitor or by cleaning your boat thoroughly after each trip.

5.8.6 Bottom Paint

Bottom painting your catamaran will also change the performance. Although not significant, you can expect a drop in speed between 1 and 5 miles per hour.

Chapter 6: SYSTEMS INFORMATION

6.1 OVERVIEW

This chapter will provide you with basic information for all the systems on your boat. Understanding this information is imperative, as it directly contributes to the safety and enjoyment of your trips on the water. If you need further information on any of these systems talk with your dealer.

6.2 FUELING GUIDELINES

Study the following guidelines thoroughly, and consult your dealer if you have questions. Be sure to read the engine manufacturers recommendations regarding the type and grade of fuel to use for your engines. If you are using a 2 stroke outboard engine, be sure to fill the oil tanks with manufacturer approved oil during each fill-up.

!!! WARNING

Avoid methanol or other alcohol based fuels or additives which can deteriorate fuel hoses, Alcohol based fuels also absorb water which can lead to engine damage.

!!! DANGER

Follow all safety guidelines while fueling. Leaking or spilled fuel is an explosion hazard. Regular checks of the fuel system are needed to protect you and the vessel.

!!! DANGER

Static electricity can ignite gasoline vapors causing serious injury, death and /or destruction of property.

6.2.1 Before Fueling

- Shut down the engines and turn off all electrical devices including the batteries.
- Close all hatches, portlights, and doors to prevent accumulation of fuel vapors.
- Extinguish cigarettes or other lighted materials.
- Keep a properly charged and correctly rated fire extinguisher nearby.

6.2.2 During Fueling

- Use common sense and obey all safety regulations related to fuel handling.
- Avoid static sparks by maintaining contact between the fuel nozzle and fuel fill.

6.2.3 After Fueling

- Secure the fuel cap and inspect for leaks.
- Clean up any spilled fuel and dispose of the cleaning material accordingly. Do not store fuel soaked material on your boat.
- Open all hatches, portlights, and doors to allow for ventilation.
- Check for fuel vapors using a “sniff test” and do not turn on electrical devices, including batteries, until you are certain the fumes have dissipated.

6.3 FUEL SYSTEM

Due to the nature of the hull design, your World Cat is equipped with a port and starboard fuel system. These systems act independently, providing fuel to the engine on their respective side. Tanks are constructed of polyethylene material to prevent corrosion.

Hose are NMMA certified, and fittings are clamped securely to reduce the potential for leaks. However, comprehensive checks of hoses and fittings should be completed at least annually, including those normally hidden from view. Tighten all connections, replace deteriorated hoses, clamps or fittings, and replace the fuel/water separators during this check. World Cat has provided inspection plates in the cockpit floor and along the gunwales to assist you with annual maintenance. To access the inspection ports along the gunwale, you will need to remove the cockpit bolsters by removing the screws that hold it in place. To access the screws, pull up gently on the bottom of the bolster and locate the drain grommets. The factory installs screws in every other grommet to secure the bolster. Remove these and pull up and out on the cushion to remove.

If you experience fuel flow problems, remove the fuel feed hose from your engine and connect it to a portable fuel tank. Doing so will help you determine if your fuel system or the engine is the source of the problem. Fuel system repairs and engine maintenance should be performed by a qualified marine technician.

The fuel/water separators are installed between the tank pickup and the engine. They are located in the aft rigging space on all models except the 270TE, all 295 models and 330TE. On those models, they are mounted on the hullside and can be reached through access doors on the cockpit walls. Inspect these filters regularly and replace when needed.

6.3.1 Fuel System Benefits

- Automotive style refueling
- Automotive Nozzle shut-off
- Fuel Nozzle retention
- System send signal to the pump nozzle to shut off before there is any spit-back through the fill opening
- Overfill protection – reducing the possibility of accidental fuel spills
- Reduce hydrocarbon emission through the use of specially designed fuel fill. The fuel fill has a permanently attached cap with a positive closure mechanism with an audible click, to let you know when the cap is sealed.

6.3.2 Fuel Tank

Your boat is equipped with a Low Permeation Crosslink Polyethylene fuel tank with a fuel capacity of 121 gallons per tank. The useable capacity of the fuel tank is different from the tank capacity marked on the tank from the manufacturer. The difference is the ullage area that has been incorporated into your tank. It is recommended that you follow all the instructions regarding the filling of fuel tanks.

6.3.3 Fuel Vent

The fuel tank vent is integrated into the fuel fill deck fitting (See fig. 6.3.6) The vent serves as an over pressure/vacuum release with anti-surge and flame/spark arresting protection. The fuel vent system also plays an important role in controlling the “FULL” level of fuel with the use of FLVV (Fill Limit Vent Valve). Grade Valves have been added to the tank which allows proper ventilation of the tank when the boat is stored, or trailered, on a moderate incline, without fuel. Note all ways inspect to insure the fuel fill deck fitting is free of debris and in proper working condition.

6.3.4 Fuel Distribution System

The fuel is delivered from the tank to the engine through the “Interated Fuel Demand Valve” (IFDV), anti-siphon valve, and the fuel line. The IFDV prevents the built up pressure inside the tank from being transferred to the engine while still allowing fuel to flow as the engine requires it for operation. The anti-siphon valve is a safety feature designed to prevent the fuel from siphoning out of the tank if the fuel line were to be cut or broken below the level of the fuel in the tank. In this case, some fuel would leak from the line, but will not allow the entire contents of the tank to siphon into the boat. (See fig 6.3.6)

What does the IFDV do?

- The integrated fuel demand valve, used in conjunction with integrated fuel systems, is for below deck use, eliminates pressurized fuel from reaching fuel distribution lines and your engine and ensures that fuel is provided to the engine on demand rather than as a result of pressure in the tank. Additional features include:
 - Compatible with Ethanol blended fuels.
 - Eliminates the need for rigid fuel distribution lines in pressure relief systems (per ABYC H-24.15.9)
 - 2 year warranty



6.3.5 Filling Fuel Tanks

The fuel system is desinged to automatically shut off the fuel nozzle when the tank is full by the “Inlet Control Valve” (See Fig 6.3.6) similar to an automotive fuel system. The tank is filled when the fuel fill nozzle has shut itself off the second time. Attempting to fill the tank past this point may cause some of the components to not function properly, or malfunction.

!!! WARNING
The use of a portable fuel tank to fill your fuel tanks can result in overfilling and circumvent the safety features designed into your fuel tank system.

!!! WARNING
Modification of any of the fuel system components or the replacement of these components with unathorized parts may result in over-pressurization of the fuel system and circumvent the safety features designed into your fuel system.

6.3.6 Pressure Relief Fuel System Diagram

Pressure Relief Fuel System

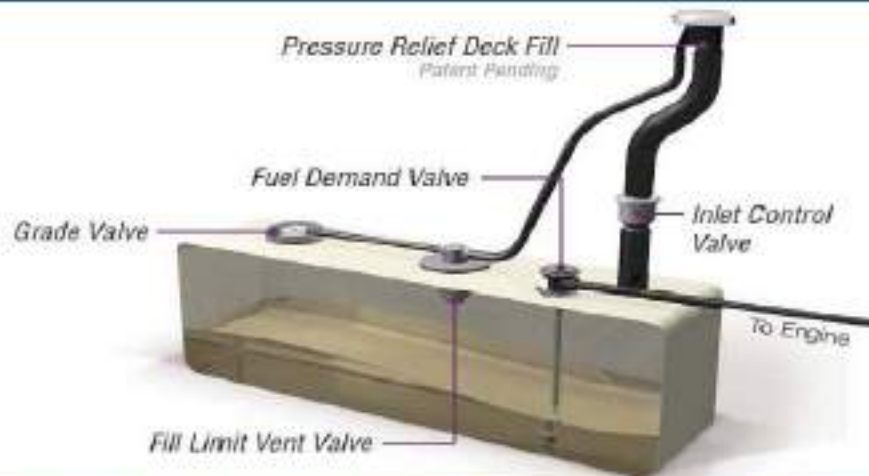

 attwood | MotorGuide

3

6.3.7 Trouble Shooting Tips

Possible Failures

- Loss of prime on the engine and or fuel starvation.
 - Symptom Engine runs normally stalls out.
 - Engine runs lean.
 - Engine does not draw fuel properly.
- Corrective action.
 - Possible leakage points
 - Fuel line leak from tank to engine – replace components as needed
 - IFDV O-Ring – replace O-Ring
 - Pick up Tube O-Ring – Replace O-Ring
 - IFDV – Replace IFDV

 attwood | MotorGuide

9

6.3.8 Integrated Fuel Demand Valve Components



6.4 ETHANOL-BLENDED FUEL

Ethanol is an oxygenated hydrocarbon compound that has a high octane rating, therefore is useful in increasing the octan level of unleaded gasoline.

NOTICE

The use of improper gasoline or additives can damage your fuel system and is considered misuse of the system. Damage caused by improper gasoline or additives WILL NOT be covered under warranty.

6.4.1 Additives

There is no practical additive known that can prevent or correct phase separation. The only solution is to keep water from accumulating in the fuel tanks.

If phase separation does occur, your only remedy is to drain your fuel tanks, clean and dry the tank completely and refill with fresh fuel.

6.5 ELECTRICAL SYSTEM

The electrical system on your catamaran consists of three major components: the battery system, wiring and circuit protection, and accessories. It is important that you understand the principles of the electrical system, so that you can protect the components and troubleshoot any problems you experience.

6.5.1 Battery System

Your World Cat is equipped with three batteries. Two of the batteries are dedicated as “cranking batteries” the third bank controls the DC accessories and is commonly referred to as the “house” bank. To help maintain your batteries, a management system is installed on your boat. This system, controlled by a panel similar to the one shown below, enables you to engage or disconnect the batteries, distribute electrical charge, and parallel batteries in the event of a failure. Chapter 10 of this manual will provide details regarding the location and wiring of your batteries and management panel.

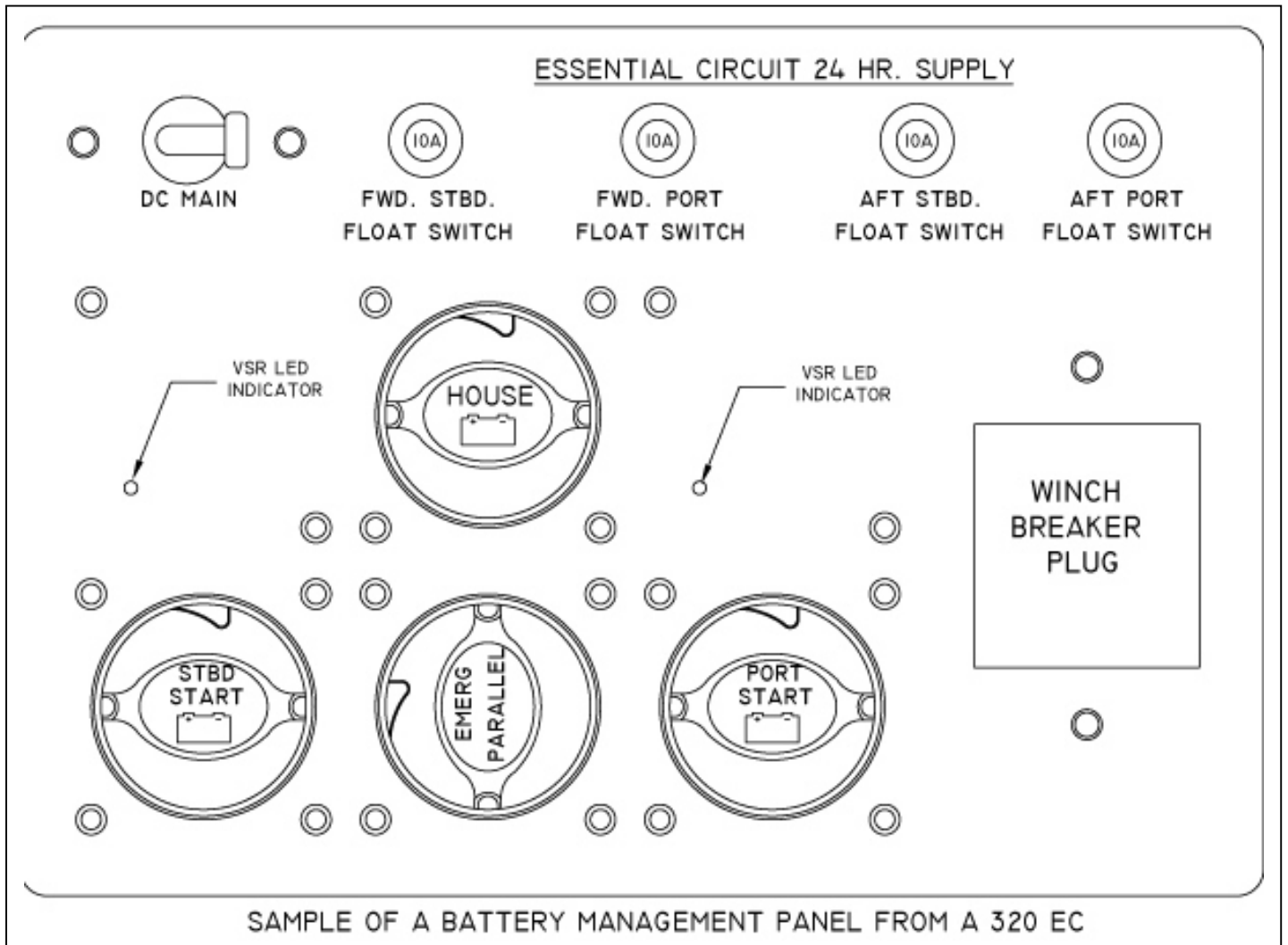

6.5.2 Battery Distribution

The drawing above illustrates the normal operating position for the battery management panel. The “PORT START”, “STBD START”, and “HOUSE” switches as well as the “DC MAIN” breaker are in the “ON” position and the “EMERG PARALLEL” is “OFF”. In this position, you are supplying power to the engines through the cranking leads and to the DC accessories through the 50 Amp “DC MAIN” breaker. When you have finished your trip, turn the “PORT START”, “STBD START” and “HOUSE” switches off prior to leaving the boat. The “DC MAIN” can remain “ON” at all times.

6.5.3 Voltage Sensor Relay (VSR)

The twin voltage relay sensors are integrated into the battery switch cluster. They distribute the charging output from the engine alternator to the “cranking” and “house” batteries. After starting an engine, the alternator sends electricity back to the “cranking” battery to recharge it. Once the “cranking battery” is fully charged (13.6 volts), the VSR closes to allow the alternator output to charge the “house” battery. When the VSR is operating, the LED indicator located on the management panel will be lit. It will remain lit until the battery is fully charged, or the “cranking” battery voltage falls below 12.8 volts. It is common for the VSR to cycle “ON” and “OFF” during operation. However, constant cycling could indicate a problem in the system and should be checked by your dealer.

6.5.4 Emergency Parallel

In the event of a battery failure, the “EMERG PARALLEL” switch allows you to mechanically link the port “cranking” battery to the starboard engine or vice versa. The switch should remain in the “OFF” position when not in use. To prevent voltage spikes or drops which can damage electrical components, you cannot draw power from the house battery using the “EMERG PARALLEL” switch.

6.5.5 24 Hour Circuits

The push-in or toggle style breakers located across the top of the management panel protect the 24 hour essential circuit wiring. Per NMMA and USCG guidelines, these breakers are constantly energized to provide power for bilge pumps and memory functions. This helps to protect your vessel even when you are not available. The “HOUSE” switch does not need to be “ON” for these breakers to have power. Inspect the breakers regularly, and push-in or flip the toggle to reset. If a breaker trips constantly, have your dealer investigate the problem as soon as possible to prevent damage to your boat.

NOTICE

Windlasses used incorrectly could cause harm to equipment or crew
Windlasses should be used with care and treated with respect
Lewmar windlasses are designed and supplied for anchor control in marine applications and are not to be used in conjunction with any other use.
It is the unaboidable responsibility of the owner or master or other responsible part to assess the risk of any operation on the vessel.

6.5.6 Anchor Windlass

A 50 Amp breaker is installed at the factory for the anchor windlass. Windlass Deck Switch Maintenance. Refer to section 7.11 for details on maintenance provided by Lewmar

6.5.7 Windlass Deck Switch Maintenance

Refer to section 7.11 for details on maintenance provided by Lewmar

!!! DANGER

Disconnect the battery cables from the batteries prior to removing or working on the battery management panel. Failure to do so could result in electric shock. Reference the NMMA pamphlet in your “Owner’s Portfolio” for more information.

6.6 BATTERY SELECTION

World Cat supplies the original batteries onboard your vessel. We use both Group 27 and Group 31 batteries. In the event of a failure, replacements must be of equal size and specifications (see below):

GROUP 27 (27MG)

CCA: 840

MCA: 1050

RESERVE CAPACITY: 182 min @ 20A

GROUP 31 (GDP31DT)

CCA: 700

MCA: 875

RESERVE CAPACITY: 182 min @ 25A

6.7 BATTERY CARE

Batteries should be secured in a non-metallic tray and insulated boots should cover the terminals. Depending on the style of battery you choose, inspect the electrolyte and perform routine maintenance as suggested by the manufacturer. Remove corrosion from the terminals quickly to prevent failure. Use a stiff brush and a solution of water and baking soda to remove corrosion, then grease the terminals to prevent further build-up. Be careful to clean up thoroughly to avoid contaminating the electrolyte.

When servicing the batteries, follow the safety procedures shown below and work to avoid electrolyte spills which can harm you and your vessel.

!!! DANGER

All batteries contain an electrolyte, commonly sulfuric acid, which is a caustic and volatile chemical. Use extreme caution when charging or servicing.

6.7.1 Safety

- Use protective clothing and accessories such as aprons, gloves, and eye wear to protect yourself while servicing batteries.
- Avoid cigarettes, open flames, and sparks. Batteries can produce toxic and explosive gases; therefore, store or charge them in a well ventilated space.
- Keep batteries out of the reach of children and pets.

6.7.2 Exposure

If you are exposed to the electrolyte solution, follow these procedures and seek immediate medical attention.

EXTERNAL - Flush with large amounts of water for contact with the skin. If severe irritation occurs or it contacts your eyes, seek medical attention immediately.

INTERNAL - Consume large amounts of water or milk, coupled with milk of magnesia, a beaten egg, or vegetable oil. Seek medical attention immediately.

The guidelines above are basic and do not alleviate the owner of responsibility should an accident occur. Use good judgement and common sense to avoid an accident.

!!! CAUTION

When reconnecting your batteries, always connect the black cable to the negative terminal and red cable to the positive one. Reversing them can damage your electrical system and create the potential electric shock.

!!! CAUTION

Never disconnect a battery while underway. Doing so may result in damage to your boat's electrical system and the engine's alternator.

6.8 WIRING AND CIRCUIT PROTECTION

Your World Cat is wired using marine grade tin coated copper wire, instead of standard copper wire. Tin coated copper is manufactured to withstand the harsh saltwater environment better than standard copper, which is used for residential applications. Environmentally sealed Deutsch™ connectors are installed on all accessories located below the waterline to ensure watertight connections. The remaining devices are installed with high quality splices and terminals, which are heat shrunk to protect the integrity of the connection. Harnesses are routed through PVC rigging tubes to prevent chaffing and covered with sheathing when necessary.

6.9 CONTROL SYSTEM

Your World Cat is equipped with a traditional switch operated DC control system. In the traditional setup, circuit protection is located above the switches on the instrument panel. A label is mounted on the control unit to advise you which breaker controls a given appliance. If a breaker trips simply push it in to reset. When possible have your dealer replace defective electrical components. If that is impractical, be certain to use identical replacements to ensure the integrity of the system.

!!! CAUTION

Failing to use the correct replacement breaker could result in failure of the device or damage to the electrical system. Contact your dealer for repair information.

Accessories not integrated into the control unit can include lights with integrated switches, marine head controls, stereos, aftermarket electronics and 12V outlets. These devices draw current from the accessory fuse blocks. The fuse blocks are similar to those found in automobiles, and use snap-in fuses to protect a circuit. You can obtain replacements for these fuses from your dealer or local auto-parts store. Always replace a damaged fuse with one of equal rating.

Ground blocks are another integral part of your electrical system. These are connected to the common battery ground and individual appliances, to provide a path for current flow back to batteries.

!!! CAUTION

When working on your electrical system, disconnect the batteries to prevent shock, or damage to your electrical system. If possible, have an electrician perform repairs.

For customers unfamiliar with electrical systems, World Cat recommends the following book:

Boating Magazine's: Powerboater's Guide to Electrical Systems

Written by: Ed Sherman

Publisher: International Marine (Division of McGraw Hill Companies)

Copyright: 2000 International Marine.

6.10 ACCESSORIES

Electrical accessories include all lights, pumps, and gauges assembled into your catamaran. Certain accessories are standard to each model, while others are optional equipment. Below is a list of accessories and their function. Beside each accessory is a list of the boats on which the item is standard. For information on optional equipment see Chapter 10 in this manual.

6.10.1 Navigational Lights

Per USCG guidelines, all powered vessels must have navigational and anchor lights. Every World Cat is equipped with navigational lights at the bow, a pole light near the stern, or mast light on the hardtop. These lights must be used in accordance with USCG regulations when anchored or underway.

6.10.2 Cockpit Lights

Cockpit lights are located at floor level to provide light while operating in low light conditions.

6.10.3 Cabin / Console Lights

Lights located in the cabin or in consoles have an integrated power switch and are tied directly into the fuse block. Operate them with the switch located at the base of the light.

6.10.4 Spreader Lights (Standard on Hardtop)

Attached to the hardtop or hardtop frame, spreader lights illuminate the cockpit in low light situations. They are operated using the switch on the dome light or instrument panel and are protected by a fuse block.

6.10.5 Dome Light (Standard on Hardtop)

Located under the hardtop radio box, this light features both white and red lamps for nighttime operation. It is powered by the fuse block located in the radio box.

6.10.6 Bilge Pump / Float Switch

Bilge Pumps evacuate standing water in the bilge. They can be operated manually, or automatically by the float switch. The float switches are connected to the fuses along the top of the battery management panel.

6.10.7 Raw Water Pump

Supplies pressure to the raw water system. It contains a pressure switch similar to a residential well pump. You can leave this appliance on at all times while underway.

6.10.8 Freshwater Pump

Supplies pressure to the freshwater system. It contains a pressure switch similar to a residential well pump. You can leave this appliance on at all times while underway.

6.10.9 Livewell Pump

Supplies water to the livewell system and is activated by rocker switch.

6.10.10 Macerator Pump

Used to evacuate waste and debris from fishboxes or to remove waste from marine head holding tanks.

6.10.11 12v Outlets

Located strategically throughout the boat, these outlets provide power to aftermarket accessories such as cell phones, electric reels, and spotlights. Each outlet is independently wired to the fuse panel.

6.10.12 Marine Head

The marine head is powered by the fuse panel, and has a separate control panel mounted near the head. The control panel activates the solenoid to allow for water intake and discharge. A macerator pump is incorporated into the head. See section 10.1.8 in this manual for operating instructions.

6.10.13 Anchor Windlass - Freefall

Use to deploy and retrieve the anchor. This accessory is controlled by a dedicated switch at the helm and can also be controlled at the bow with up & down foot switches. The fuse is located at the battery management panel.

6.10.14 Stereo (optional)

Similar to an automotive stereo, the unit can be operated using the faceplate or a remote keypad which is mounted near the helm. It is powered by the fuse block, and the memory wire is connected to a 24 hour circuit.

6.10.15 Windshield Wipers

Operated by a dedicated rocker switch at the helm, these function identically to those found on passenger automobiles.

6.10.16 Horn

Function identically to those found on passenger automobiles.

6.10.17 ACC

“ACC 1” is reserved for the standard freshwater pump on most models. However, the remaining “ACC” switches can be used to operate aftermarket products. ***Be aware of the power requirements for any add-on products, so you do not exceed the capacity of the breaker supplying the switch.*** Failure to do so could damage the appliance and/or the electrical system.

6.10.18 Power steering

The power assist unit provides automobile like steering on your catamaran. The unit is installed in the console between the helm and steering rams. The power for the unit is connected to the port and starboard key switch if you should decide to troll with one engine your power assist will still be operational.

6.11 GAUGE PACKAGES

World Cat provides Suzuki™ and Yamaha™ engine packages with manufacturer supplied instrumentation. Below is a list of the standard packages and a description of their function.

6.11.1 Yamaha™

Yamaha™ packages feature a dedicated speedometer and fuel management gauge. Instructions on the operation and features of these gauges is included in your engine owner's manual.

6.11.2 Suzuki™

Suzuki™ packages feature a three or four piece digital gauge package (same as Yamaha™) with a tachometer for each engine, and a programmable multifunction gauge(s). World Cat setups a preliminary program at the factory, but it can be modified to suit your needs. Instructions on the operation and features of these gauges is included in your engine owner's manual.

6.12 PLUMBING SYSTEM

The intake and discharge of water is integral to several of the features and accessories provided on your boat, including livewells, fishboxes, sanitation devices, and water systems. World Cat installs the plumbing components for these systems using high quality marine hoses and stainless clamps. However, this does not eliminate the need for routine checks of plumbing components or connections. A failure resulting from a deteriorated hose or connection, could cause your boat to take on water or become swamped. Information is provided in Chapter 10 of this manual, regarding the location, function, and routing for the plumbing components on your boat. Review these materials and talk with your dealer should you have a question.

Chapter 7: MAINTENANCE AND SERVICE

7.1 OVERVIEW

This chapter provides basic information for maintaining the original appearance and dependable performance of your World Cat. Although your vessel is constructed of the finest materials available, the harsh saltwater environment and other factors, including geography and usage rate, will affect its finish and function over time. It is imperative that you understand how to care for your catamaran properly. Some simple steps will help maintain its aesthetics, value, and reliability.

7.2 GELCOAT MAINTENANCE

Gelcoat is a thin layer of resin mixed with colored pigments, which provides the exterior finish on your boat. Gelcoat provides a smooth durable surface to protect the fiberglass construction of the hull, but is still flexible enough to absorb the pressure exerted upon it during operation. Mainly used for cosmetics, gelcoat is relatively simple to maintain. However, without routine cleaning, it will discolor due to the microscopic pores in the surface. Following are some instructions for maintaining your gelcoat.

7.2.1 Cleaning

After each trip on the water, or after trailering long distances, you should clean the boat immediately. Washing the boat with mild detergents, such as dishwashing soaps, and fresh water will help eliminate build up or discoloration resulting from environmental pollutants. Use a sponge or other soft cleaning device on the smooth exterior surfaces of the hull and deck. A soft brush can be used when cleaning nonskid portions of the deck. Make sure to rinse the boat thoroughly after cleaning.

!!! CAUTION

Using strong or caustic cleaning agents, such as bleach, citrus based cleaners, or one containing ammonia, will damage the appearance and strength of your gelcoat.

7.2.2 Waxing

Similar to automotive finishes, gelcoat will begin to fade over an extended period of time. Constant exposure to environmental pollutants and this aging process will result in a loss of shine. However, it is possible to restore the original luster and color using a polishing compound (mild abrasive) or a rubbing compound (harsh abrasive). Each will remove scratches, discoloration, and help restore weathered gelcoat surfaces but you should select what to use based on the severity of the problem. Use the following steps to restore the finish of your gelcoat.

- Clean the affected area completely using a mild detergent.
- Gently wet sand the affected area using a fine sandpaper (600 grit) to remove any stains. Use plenty of water and always sand in one direction using curved strokes. Sanding in alternating directions could result in damage to the finish.
- Apply polishing compound to a buffing pad and follow the manufacturers instructions. If you apply the compound mechanically, we recommend a lamb wool buffing pad and a electric buffer capable of 1750 to 1800 RPM.
- When you have completely buffed the area, wash away any remaining compound using clean water.
- After thoroughly cleaning the surface, wax the affected area. This will help restore the finish and provide a seal against future discoloration.

!!! CAUTION

Protect metal surfaces when using abrasive cleaners, polishing compounds or rubbing compounds. They can damage the metal's protective finish leading to rust.

!!! CAUTION

When using an electric buffer, maintain constant motion. Allowing the pad to rest on an isolated spot can cause heat buildup, which can damage the gelcoat.

!!! CAUTION

Routinely clean and wax your catamaran to help prevent the need for excessive use of rubbing and polishing compounds, which over time can deteriorate the gelcoat.

By following the instructions listed above you can guarantee that your catamaran will remain in near showroom condition and remain a source of pride for years to come.

7.2.3 Repair

Although gelcoat is a flexible material capable of handling environmental punishment and extended use, it is susceptible to scratches, blistering and cracking over time. Gel coat distortion or cracking is unappealing, but rarely represents any structural failure. Have your dealer inspect any damage to your gelcoat to determine the nature of the failure. If it is only cosmetic, they can provide color matched kits, instructions, and any chemicals you need for application or cleanup. Structural damage should be repaired by your dealer or a trained fiberglass repair shop.

!!! WARNING

Gelcoat and the chemicals used for its application and cleanup are extremely flammable and toxic. Follow all handling and mixing instructions, provide for proper ventilation, and keep water containers nearby to submerge catalyzed materials.

7.3 BOTTOM PAINT

If you intend to leave your boat in wet storage, or routinely dock it for more than a few days, you should coat the hull beneath the water line with anti-fouling paint. This will help prevent marine growth, such as barnacles, which damage the gelcoat and affect performance. World Cat recommends using an epoxy barrier coat prior to boating painting a new vessel. This will help to prevent, but not eliminate, gelcoat blistering on the hull, which is not warranted by World Cat. Your dealer can provide information on bottom painting to protect against environmental toxins in your area. Anti-fouling paints are made to dissolve over time, so inspect and clean the hull bottom annually and recoat when necessary.

7.4 UPHOLSTERY

Basic Stains - Clean with a mild detergent and a soft to medium brush, or an all purpose cleaner such as Fantastic™. Rinse with fresh water after cleaning.

Mildew - Use a 4 to 1 mixture of water and ammonia, brushing the stain vigorously to remove the bacteria responsible for the mildew. If the stain remains, briefly apply bleach to the area and rinse with fresh water.

!!! WARNING

Do not mix ammonia and household bleach. Doing so will result in the formation of deadly chlorine gas. If it is necessary to use bleach, clean up any traces of ammonia and ventilate the work space for a minimum of 15 minutes prior to applying bleach.

Tough Stains or Mildew - Use a mixture of 1 tablespoon of ammonia, 1/4 cup of hydrogen peroxide, and 3/4 cup distilled water. Briefly, apply to the surface, allowing the peroxide to bubble. Rinse with fresh water.

7.5 TRIM / PLEXIGLASS / POLYETHYLENE

World Cat uses vinyl, plexiglass, and polyethylene material (Starboard™) throughout the interior of our catamarans. Use the following instructions to care for these items:

- Use mild detergents to clean vinyl trim commonly used in cabins and helm. Routinely use a commercially available surface protector to seal the vinyl.
- Surface or glass cleaners can be used to clean plexiglass. It is commonly used for radio boxes and as a protective material for instrument panels.
- Starboard™ can be cleaned using surface cleaners such as 409™.

7.6 STAINLESS / ALUMINUM

Stainless steel and aluminum are used throughout your vessel. World Cat uses only 316 marine grade stainless hardware and anodized aluminum to provide you with years of service; however, these metals can deteriorate and fail if improperly cared for. Upon returning, clean all hardware using a mild detergent and rinse thoroughly with fresh water. Avoid using abrasive cleaners or chlorine based products, as they will remove the metal's protective coating and lead to pitting or rust. Throughout the year coat the metal using a non-abrasive metal protector to help displace moisture, remove contaminants, and shield the metal. World Cat recommends high quality sealants such as Boeshield T-9™ developed by Boeing™ Aviation. If you cannot find it locally call PMS Products Inc. at 800-962-1732.

7.7 POWDER COATING (PAINTED) ALUMINUM SURFACES

Regular care is necessary to maintain the appearance of the powder coat finish. Buildup of salt and grime can hold moisture and damage powder coatings. This buildup can cause a corrosive condition that can damage the coating, especially in a salt air or coastal environment.

- Use a mild detergent and rinse thoroughly with fresh water.
- Avoid using any kind of abrasive cleaners or chlorine based products.

If chipping or scratches occurs we recommend that you make the necessary repairs with color match touch-up paint which has been included in your owners bag.

7.8 BILGE COMPARTMENTS

Routinely check the condition of the bilge compartments in your boat. This will help identify potential problems and eliminate odors associated with stagnant water and the buildup of residue. Clean the compartments using a freshwater rinse. This will also enable you to check the function of your drain system and the operation of the bilge pumps.

7.9 COCKPIT DRAINS

Your World Cat has four drains located in the cockpit, two on both the starboard and port sides. These drains are designed to quickly evacuate the cockpit should the boat become swamped. Flushing these drains routinely will ensure the safety of your crew and vessel, as well as, eliminate the potential for odors associated with fish residue. These drains are evacuated through the scuppers located on the hullside. Each scupper has a rubber flap to prevent water from entering the boat. Check this material occasionally to keep them free of debris and in good working condition.

7.10 WINTERIZATION

Routine maintenance checks should be performed prior to each trip in accordance with Chapter 1, but a broader analysis should be done before winterizing your catamaran and prior to the first trip of the season. If your local climate does not require winter storage, complete the following steps at least annually to ensure the safe operation of your boat.

- Do not leave loose items or personal affects onboard during storage. Remove all trash and debris prior to cleaning the boat.
- Before storage clean the boat thoroughly, including exterior surfaces, fishboxes, livewells, and thru hull fittings. If possible leave lids open slightly to allow fresh air exchange. Remove the garboard drains and store the boat with the bow up to allow drainage.
- Inspect all electrical connections and the operation of pumps or other electrical devices. Perform repairs if necessary. Coat electrical panels with an anti-corrosive spray, available from your dealer.
- Inspect the batteries and charge fully to prevent damage during storage. Disconnect the cables and apply a coat of grease to the terminals to prohibit corrosion.
- Inspect all plumbing components and connections to prevent leaks. Replace any damaged hoses. Drain all lines and devices to prevent damage from freezing. Lubricate valves to maintain proper operation. Use the manufacturers recommendations for portable and marine heads.
- Inspect fuel system components and replace fuel/water separators. You can keep the system fuel but do not overfill, and use a fuel additive to prevent condensation.
- Lubricate hinges and coat all metal surfaces with Boeshield T-9™ or other metal protector. Tighten down hardware if necessary.
- Inspect caulking around hardware, windows, hatches, etc. to prevent water damage. Normal use will break down sealants and can lead to costly repairs if not maintained.
- Remove or cover all electrical devices to prevent damage from UV rays. The rays will cloud electrical displays and make them hard to read.
- Remove cushions and store indoors to prevent damage.
- Winterize the engines and controls per manufacturers recommendations and inspect all connections, filters, and parts thoroughly. Replace parts as needed.

7.11 MAINTENANCE SCHEDULE

Maintenance	Each Use	Weekly	Monthly	Each Season	Yearly	As needed
Clean hull below the waterline				X		
Bottom paint the hull					X	X
Check/Replace Sacrificial Anodes			X			
Wash boat hardware and canvas	X		X			
Wax exterior gelcoat				X		X
Clean & protect hardware						X
Clean exterior upholstery	X					X
Clean cabin & interior upholstery						X
Flush engines with fresh water	X					
Spray metal components in bilge			X			
Clean bilge				X		X
Check bilge for leaks	X		X			
Inspect steering & controls	X					
Inspect fuel systems for leaks	X					
Replace fuel filters				X	X	X
Lubricate fuel fill O-rings			X			
Inspect fire extinguisher			X			
Test bilge pump auto switches			X			

7.12 LEWMAR (PROVIDED BY LEWMAR)



DECK SWITCH SERVICE UPDATE

JUNE 2011

Overview

Electric deck switches operate in a hostile environment and are subject to salt water, extremes of temperature, direct sunlight and UV effect. They are also susceptible to wear and tear following repeated use and can in some instances suffer accidental damage during boat operations. It is therefore recommended that regular visual and functional inspection of the switch, the circuitry and the equipment being controlled is carried out by a competent qualified person on a regular basis.

If any defects are noted on the switch (see point 2.0 below), replacement is mandatory so as to avoid the possibility of a malfunction. It is further recommended that an item of this nature is not intended to remain in service forever. The lifespan will depend upon the weather and UV conditions to which the switch is exposed as well as the amount of use. Therefore, a service lifespan of 3 to 5 years from date of purchase can be expected, after which time it should be replaced. Shorter lifespans could be experienced and the following inspection recommendations are therefore important in ensuring continuing safe operation.

Inspection

- 1.0 The deck switch and the system it controls should be fully tested in a 'No Load' condition prior to full functional operation as per it's design purpose, before every trip, activity or task. Only after the skipper has satisfied themselves of the safe and functional operations should the equipment be used.
- 2.0 The deck switch should be inspected pre-departure or use paying particular attention to the following:
 - 2.1 Ensure there is no visible damage to the switch
 - 2.2 Ensure there is no noticeable wear to the switch, it's housing, it's button or fixings
 - 2.3 Ensure the rubber membrane over the switch is not sticky or has any deposits or residue from cleaning fluids or other prohibited materials
 - 2.4 Ensure the rubber membrane over the switch does not show any signs of cracks, splits or signs of degradation. This includes a change in colour from shiny to a matt finish
 - 2.5 The main switch housing should not have any visible chips or cracks
 - 2.6 The switch should have a smooth positive feel with a distinct click that can be felt at the point of operation
 - 2.7 There should be no signs of water ingress on any part of the switch assembly
 - 2.8 Ensure that the fixings screws and seal to the deck bulkhead or coach roof are secure, and remain effective in both securing the switch and preventing water ingress
 - 2.9 The switch should not feel spongy and should not make a squelch or bubbling noise due to water ingress when depressed and operated

NOTE

If any of the points highlighted in 2.0 through to 2.9 are detected during inspection, the deck switches should not be used and should be replaced.

- 3.0 On an annual basis the deck switch should be removed by a qualified electrical technician to carry out the following:
 - 3.1 All the checks detailed in 2.0 – 2.9 of this product service update
 - 3.2 Inspect the underside of the deck switch for signs of corrosion, damage or water ingress
 - 3.3 Inspect the wiring for signs of loose connections or corrosion
 - 3.4 In open circuit mode (OFF) condition the resistance should be checked for a recording on the test meter beyond measurement to confirm no electrical connection.
 - 3.5 In closed circuit mode (ON) condition, the resistance should be less than 3 Ω (ohms)
 - 3.6 If the switch shows any signs of excessive wear, degradation in it's action, water ingress or loss in it's electrical resistance properties, it should be changed immediately

LEWMAR[®]

DECK SWITCH SERVICE UPDATE

JUNE 2011

Additional Guidance

- 4.0 It is the responsibility of the skipper to ensure that crew members are trained in the operation of powered deck equipment and use it in a safe and appropriate way within its designed operating parameters. This includes what to do in an emergency.
- 4.1 It is the responsibility of the skipper to ensure that crew members are appropriately briefed on all three methods of equipment isolation in event of emergency, i.e. :-
 - 4.1.1 The switch itself and its operation
 - 4.1.2 The circuit breaker on main panel
 - 4.1.3 The main battery isolation
- 4.2 Crew briefings should always cover the following issues pertaining to deck switch operated equipment:-
 - 4.2.1 Safe operation of any powered deck equipment.
 - 4.2.2 What to do in the event of an emergency
 - 4.2.3 What not to do in event of emergency
 - 4.2.4 A practical demonstration of the effective isolation of deck equipment as highlighted in point 2 above
- 4.3 Deck switches are designed to be used in conjunction with Lewmar equipment only. If they are to be used for the powering of any other electrical equipment the intended use should be checked against the specification of the switch.
- 4.4 Deck switches should only be operated with fingers, bare feet or soft soled shoes.
- 4.5 Switches should be left with the lid closed to minimise environmental degradation and the potential for accidental operation.
- 4.6 Powered deck equipment should always be isolated when not in use to prevent accidental start up.
- 4.7 The instructions for the equipment being operated should always be read and followed.
- 4.8 Power washers should not be used on or near any switch.
- 4.9 It is acknowledged that deck switches will need to be washed down as part of a deck cleaning process. However, direct flow from a non pressure hose should not be aimed at the switch.
- 4.10 The deck switch itself should only be cleaned with a mild soap and washed off immediately with a light application of fresh water.
- 4.11 The following (non exhaustive) list of substances should not be applied, or used on or near any deck switch. Products include but are not limited to:-
 - 4.11.1 Chemicals
 - 4.11.2 Deck cleaners
 - 4.11.3 Petroleum based fluids/cleaners
 - 4.11.4 Deck polish
 - 4.11.5 Deck brightener
 - 4.11.6 Varnish/acquers/paints
 - 4.11.7 Oil

LEWMAR[®]

DECK SWITCH SERVICE UPDATE

JUNE 2011

Specific Considerations for Winch Operation Manual B2303 Issue 7

Winch Operation

Please ensure that you thoroughly understand the operation and safety requirements of the winch before commencing the installation. Only persons who are completely familiar with the controls and those who have been fully made aware of the correct use of the winch should be allowed to use it. If there is any doubt of how to install or operate this unit please seek advice from a suitably qualified engineer.

- *Winches used incorrectly could cause harm to equipment or crew.*
- *Winches should be used with care and treated with respect.*
- *Sailing, like many other sports can be hazardous. Even the correct selection, maintenance and use of proper equipment cannot eliminate the potential for danger, serious injury or death.*
- *Lewmar winches are designed and supplied for line control in marine applications and are to be used in conjunction with appropriate clutches, cleats and other manual controls and stoppers.*
- *It is the unavoidable responsibility of the owner or master or other responsible party to assess the risk of any operation on the vessel.*
- *Under no circumstances should any self tailing winch be used in self tailing mode for any lifting operation; rather suitable and adequate manual tailing should be arranged with proper means of manually cleating or stopping the hoist.*
- *Every winch should be installed with adequate means of manually cleating or stopping the loaded ropes.*

Specific Considerations for Windlass Operation Manual 65001201 Issue 2

Windlass Operation

Classification Societies and Lewmar require that a vessel at anchor must have its rode held by a chain stopper or equivalent strong point at all times!

At all times it is the responsibility of the boat user to ensure that the anchor and rode are properly stowed for the prevailing sea conditions. This is particularly important with high-speed powerboats, because an anchor accidentally deploying while under way can cause considerable damage. An anchor windlass is mounted in the most exposed position on a vessel and is thus subject to severe atmospheric attack resulting in a possibility of corrosion in excess of that experienced with most other items of deck equipment. As the windlass may only be used infrequently, the risk of corrosion is further increased. It is essential that the windlass is regularly examined, operated and given any necessary maintenance.

Please ensure that you thoroughly understand the operation and safety requirements of the windlass before commencing the installation. Only persons who are completely familiar with the controls and those who have been fully made aware of the correct use of the windlass should be allowed to use it. If there is any doubt of how to install or operate this unit please seek advice from a suitably qualified engineer.

LEWMAR[®]

DECK SWITCH SERVICE UPDATE

JUNE 2011

- *Windlasses used incorrectly could cause harm to equipment or crew.*
- *Windlasses should be used with care and treated with respect.*
- *Sailing, like many other sports can be hazardous. Even the correct selection, maintenance and use of proper equipment cannot eliminate the potential for danger, serious injury or death.*
- *Lewmar windlasses are designed and supplied for anchor control in marine applications and are not to be used in conjunction with any other use.*
- *It is the unavoidable responsibility of the owner or master or other responsible party to assess the risk of any operation on the vessel.*

Additional Information

- *Lewmar recommends the use of appropriate Personal Protective Equipment and hands free communication equipment by any person going aloft, and only then where the person going aloft is properly trained in the use of that equipment and where there remain sufficient trained and experienced personnel on deck to ensure constant observation and the continued safe conduct both of the vessel and the hoisting operation.*

7.13 MAINTENANCE LOG

Service Date	Engine Hours	Dealer	Service / Repairs

Chapter 8: HURRICANE PREPAREDNESS

North Carolina MARINA / BOATYARD HURRICANE PREPARATIONS

CUSTOMER CHECKLIST

Equipment To Be Kept On Board:

- chafing gear
- fenders
- two sufficient anchors with 300' or more oversized rode
- flashlight with spare batteries
- battery-operated radio

Check Monthly:

- exterior lights operable
- auto bilge pump operating (check battery)
- hatches are watertight
- power and electric gear operating
- engine battery charged
- flashlight battery charged
- radio batteries charged

To Do At A New Marina:

- learn marina approaches and basin
- learn the size and type of your mooring
- ensure mooring and lines are sufficient for all likely wind direction and velocity
- ensure mooring has enough weight and scope and is properly set
- learn your moorage lease and rental agreement responsibilities
- learn responsibilities for your boat's safety when a hurricane is approaching
- develop a plan for securing your vessel outside the marina if you plan to evacuate
- if evacuating, visit the site by boat and time the trip
- learn what possible delays you may encounter when evacuating (drawbridges, boat traffic etc.)
- photograph your boat and surroundings
- keep a list of all equipment on board
- keep a list of all equipment that will be removed during storm preparations
- keep a complete set of records for your boat at home
- give the marina operator the name and number of your absentee skipper
- give the marina operator a description of your boat, registration number and location

DOCKED BOAT PREPARATIONS

- strip all removable items, including spare rigging
- clear self-bailing cockpit drains
- close all through-hull fittings
- set chafing gear where lines will rub (chocks, cross lines, deck edge, dock edge etc.)
- remove portable fuel and oil storage containers
- remove ship papers
- shut off fuel tanks
- leave anchor light on
- leave auto bilge pump on
- check openings to ensure boat is watertight
- set and check storm anchors
- consider attaching 3 sets of bow and stern spring lines
- consider attaching lines to cleats at a 45 degree angle
- consider tying your boat between two piers or along a pier and anchored off one side

North Carolina MARINA / BOATYARD HURRICANE PREPARATIONS

MOORED BOAT PREPARATIONS

- Make Plans To Have Someone Pick You Up From Your Boat Before The Storm Arrives
- strip all removable items, including spare rigging
- clear self-bailing cockpit drains
- close all through hull fittings
- remove portable fuel and oil storage containers
- remove ship papers
- shut off fuel tanks
- leave anchor light on
- leave auto bilge pump on
- check openings to ensure boat is watertight
- use storm pennants to increase scope
- attach chains directly to pennants instead of swivels
- add an emergency catenary weight at the vessel end of the chain
- use double or triple chafe protection
- use chafing gear over entire length of pennants
- use two pennants
- if no permanent mooring is available, use two storm anchors at 45-degree angles

TRAILERABLE BOAT PREPARATIONS

Store in a garage:

- strip all removable items, including spare rigging
- clear self-bailing cockpit drains
- close all through-hull fittings
- remove portable fuel and oil storage containers
- remove ship papers
- shut off fuel tanks
- leave auto bilge pump on
- check openings to ensure boat is watertight
- _____
- _____
- _____

If no garage is available:

- secure trailer to a sturdy object
- let half the air out of the trailer tires
- put wood blocks between the frame and axle
- take out the drain plugs
- cover with tarp
- use tie-downs
- _____
- _____

North Carolina MARINA / BOATYARD HURRICANE PREPARATIONS

ANCHORED BOAT PREPARATIONS

Make Plans To Have Someone Pick You Up From Your Boat Before The Storm Arrives

- strip all removable items, including spare rigging
- clear self-bailing cockpit drains
- close all through-hull fittings
- remove portable fuel and oil storage containers
- remove ship papers
- shut off fuel tanks
- leave auto bilge pump on
- check openings to ensure boat is watertight
- use 3 or 4 substantial anchors and good tie rope
- tie your boat high on the mainland to a substantial tree or similar structure
- do not tie parallel to the bank
- keep a navigable passage at your stern to allow other boats passage
- use enough line to allow for storm surge
- leave enough room between your boat and others to allow for swing
- take valuables off
- _____
- _____
- _____
- _____

Chapter 9: 2015 WARRANTY POLICY

1. Ten Year Limited Hull Warranty. HC Composites, LLC, herein defined as “World Cat”, warrants to the original retail purchaser (“Purchaser”) that for ten (10) years after the date of delivery to its original retail purchaser, each new fiberglass hull (defined as the one piece fiberglass molded part that acts as the vessel's running surface during operation), manufactured by HC Composites, LLC shall be free from structural defects due to material or workmanship under normal non-commercial use. In the event that HC Composites, LLC determines that the boat must be replaced, then the value offered towards the replacement boat is the factory invoice for the boat. Transfer of all accessories including engines will be at the owner's expense. At HC Composites, LLC discretion the replacement model will be an upgraded model if the original model is no longer offered.

2. One Year Components Warranty. HC Composites, LLC warrants to Purchaser that for one (1) year after the date of delivery to its original retail purchaser, all boat components manufactured by HC Composites, LLC shall be free from defects due to material or workmanship under normal non-commercial use.

3. Exclusions. This limited warranty does not cover and does not extend to any of the following:

(a) Hull or component failure caused by normal wear and tear, climatic conditions, misuse, neglect, lack of proper maintenance, accident, fire or other casualty damage, racing, overloading, negligence, modification, or commercial use; (b) windshield leakage or breakage; (c) repaired or replacement components not installed by World Cat, unless installed by World Cat selling dealer in accordance with this warranty; (d) fading, chalking, blistering or cracking of any varnish, gelcoat, paint, anti-fouling coating, metallic finish or powder coating; (e) tears, cracking, fading, discoloration or mildewing of curtains, cushions, tops, headliners or other fabric or upholstered items; (f) cost of removal or reinstallation of any component (including components manufactured by World Cat), or disassembly and reassembly of the unit containing the component; (g) speed, weight, fuel consumption and other performance characteristics of the boat. **ANY ORAL STATEMENT OR PRINTED ADVERTISING REGARDING ANY PERFORMANCE CHARACTERISTIC OF THE BOAT OR ITS COMPONENTS SHALL BE CONSIDERED AN ESTIMATE ONLY AND SHALL NOT BE RELIED UPON AS EXPRESS WARRANTY OR AS A BASIS OF THE BARGAIN FOR THE BOAT OR ITS COMPONENTS;** (h) electrolysis, galvanic corrosion, crevice corrosion, stray current or any deterioration of underwater components; (i) components not manufactured by HC Composites, LLC, whether or not warranted by the other manufacturer, even if installed by HC Composites, LLC, including but not limited to engines, propellers, generator sets, controls, electronics, batteries, appliances and air conditioning. _____(*customer initial*) Warranties provided to HC Composites, LLC by component manufacturers shall be passed on to purchaser to the extent such transfer is permitted by the manufacturer; HC Composites, LLC selling dealer will identify the authorized service dealer for any such components upon request.

4. Limitations/No other Warranties. THE REPAIR OR REPLACEMENT OF DEFECTIVE PARTS SHALL BE PURCHASER'S SOLE AND EXCLUSIVE REMEDY AND WORLD CAT SOLE AND EXCLUSIVE LIABILITY UNDER THIS WARRANTY. HC Composites, LLC obligation under this warranty is limited to the repair or replacement (at HC Composites, LLC sole election) of any covered item found to be defective, when delivered by Purchaser pursuant to written authorization and instructions from HC Composites, LLC, round-trip transportation prepaid, to HC Composites, LLC manufacturing plant or other designated repair facility _____(*customer initial*). Repaired or replaced items are warranted as provided herein for the unexpired portion of the applicable warranty period.

THIS WARRANTY, AND THE RIGHTS AND REMEDIES UNDER IT, IS EXCLUSIVE AND IS GIVEN IN PLACE OF ALL OTHER WARRANTIES, WHETHER EXPRESS OR IMPLIED, INCLUDING ANY IMPLIED WARRANTY OF MERCHANTABILITY OR FITNESS FOR PARTICULAR PURPOSE, WHETHER ARISING BY LAW, CUSTOM, CONDUCT OR USAGE OF TRADE. PURCHASER'S REMEDIES SHALL BE LIMITED AS STATED HEREIN AND HC COMPOSITES, LLC SHALL NOT BE LIABLE FOR ANY INCIDENTAL, CONSEQUENTIAL OR INDIRECT DAMAGES OR LOSSES RESULTING FROM DEFECTS.

THIS LIMITED WARRANTY GIVES PURCHASER SPECIFIC LEGAL RIGHTS. PURCHASER MAY HAVE OTHER RIGHTS WHICH MAY VARY FROM STATE TO STATE. IN THE EVENT THAT IMPLIED WARRANTIES ARE FOUND TO EXIST UNDER THE LAW OF A PARTICULAR STATE NOTWITHSTANDING THE EXCLUSION CONTAINED HEREIN, THE DURATION OF ANY SUCH WARRANTY SHALL BE LIMITED TO THE DURATION OF THE APPLICABLE LIMITED WARRANTY STATED HEREIN.

THE SELLING DEALER IS NOT A CO-WARRANTOR AND IS NOT AUTHORIZED BY HC COMPOSITES, LLC TO AMEND OR MODIFY THIS LIMITED WARRANTY IN ANY MANNER.

5. Dispute Resolution. Any controversy or claim arising out of or related to this Agreement or to the relationship created hereby, whether at common law or under statute, shall be settled exclusively by binding arbitration conducted in Edgecombe County, North Carolina, pursuant to the North Carolina Commercial Arbitration Act (the "Act").

6. Predelivery Examination. Purchaser represents to HC Composites, LLC that Purchaser has examined the boat and all its component parts, accessories and equipment, to Purchaser's full satisfaction prior to accepting delivery of the boat from HC Composites, LLC, or in the alternative, has been given full opportunity to do so and has declined. _____(Customer initial)

7. Single Transferability of Warranty. Coverage remaining under the Warranty Periods may be transferred by an Authorized HC Composites, LLC, Dealer to a 2nd purchaser for a \$395.00 fee. The transfer must occur within five (5) years of the original date of retail sale. The transfer fee must be paid within thirty (30) days of purchase of the used boat to transfer the warranty. A copy of the bill of sale from the original owner or Authorized World Cat Dealer is required and completion of this form. HC Composites, LLC, reserves the right to reject any warranty transfer request for a boat that has been damaged, neglected or otherwise previously excluded from warranty.

8. Miscellaneous. HC Composites, LLC reserves the right to make changes in the design and construction of its products at any time, without notice and without any obligation to incorporate such changes into products of prior manufacture. This limited warranty applies to new boats manufactured by HC Composites, LLC, except as such limited warranty may be transferred to a subsequent purchaser as provided herein. The term "new boats" shall include boats that may have been repaired during the manufacturing process as part of HC Composites, LLC quality assurance program. This limited warranty contains the entire agreement between HC Composites, LLC and Purchaser and supersedes all prior agreements, discussions, negotiations, commitments and representations, whether oral or written, between them regarding HC Composites, LLC warranty. If any provision of this limited warranty, or the application of it, is determined to be invalid or unenforceable for any reason, the remainder of this limited warranty and the application of it shall not be affected.

All communications and notices from Purchaser regarding this limited warranty should be sent to: HC Composites, LLC, 1090 West Saint James Street, Tarboro, NC 27886 or fax to 919-882-9357

9. Acknowledgment of Limited Warranty. By signing below, Purchaser (or each Purchaser, if more than one) agrees that he or she has read this limited warranty in its entirety and understands its terms and conditions. Purchaser (or each of them) acknowledges receipt of a copy of this limited warranty at the time of the sale.

WARRANTY REGISTRATION

Purchaser's Name

Purchaser's Phone Number

Purchaser's Street Address

Date of Delivery

Purchaser's City, State and Zipcode

Hull Identification Number

Purchaser's Email Address

Name of Selling Dealer

Purchaser's Signature

Dealer's Sales Representative

Original Owner

Second Owner

Chapter 10: 295DC OPERATION AND SCHEMATICS

10.1 OPERATION OF STANDARD EQUIPMENT

10.1.1 Battery Layout and Management

Your 295DC is equipped with three batteries, which are located in the helm storage compartment. They can be reached using the access hatch located on the floor in the aft section of the starboard liner. A cranking battery is installed on each side, and a dedicated house battery is installed in the center. Wire leads run across the liner and aft through a hull rigging tube, to the battery management panel located on the inboard wall of the port seatbox. See section 6.5 thru 6.5.5 for information regarding the operation of this panel. The engine cranking leads run aft, through a hull rigging tube, from the management panel to a positive stud mounted on the bulkhead in each aft rigging compartment. The negative engine leads are connected to the common battery ground using a negative buss also located in the aft rigging compartment.

The house battery provides the power for a majority of your DC accessories. The main battery lead runs to the “HOUSE” switch on the battery management panel. From there current is routed to the dash through the 50 amp “DC Mains 1” breaker located on the top left corner of the battery management panel. During normal operation this breaker can remain in the “ON” position, and the “HOUSE” switch can be used to control the flow of current. The main ground for all DC accessories is tied into the common ground on all batteries. The “DC Mains 2” breaker controls the DC panel located in the head compartment. The panel houses the breakers for the Windlass, Marine Head, Hardtop Power Supply, and lighting in the head compartment. The panel is powered by the Stbd Start switch, to prevent overloading of the House circuit.

10.1.2 Additional Emergency Parallel

As an additional feature, your 295DC management panel contains a secondary “EMERG PARALLEL” switch. It allows you to mechanically link the starboard “cranking” battery to the house battery. Furthermore, engaging both “EMERG PARALLEL” switches will connect all three batteries into a single bank. The switches should remain in the “OFF” position when not in use. To prevent voltage spikes or drops which can damage electrical components, you should trip the DC Mains 1 breaker prior to cranking engines with the house battery in parallel. Once you are running, the breaker can be reset to allow the full alternator output to power the electronics. This is a safety feature and should not be used in-lieu of the VSR’s to charge batteries while underway. Doing so, could result in premature battery failure and increases the risk of electrical failure while at sea.

10.1.3 Bilge Pumps / Float Switches

Your 295DC is equipped with two 1500 GPH bilge pumps. Each pump is connected to a float switch which automatically triggers the pump when water comes to rest in the bilge. The float switches are connected to the battery management panel through the hull harness and receive power from the breakers at the top right corner of the panel. These breakers are constantly energized and ensure the safety of your boat even when the battery switches are in the “off” position. The pumps can be manually engaged using the switch at the dash.

The bilge pumps are located behind the aft rigging compartment and can accessed through the inspection plates in the motorwell, forward of the engines. The wiring for these pumps is secured to the inboard side of the centerline stringer which is visible from the hatch.

Inspect the operation of your bilge pumps and their connections at least annually. To do so, activate the pump by lifting the external float switch once released the pump should shut off. Keeping your bilge areas clean can also help extend the life of your pump.

10.1.4 Freshwater System

The freshwater pump and wiring are located in the mechanical cabinet on the inboard wall of the port seatbox. The freshwater pump is connected to the 35 gallon freshwater tank located beneath the port seatbox. The tank is filled through a fitting located on the port side of the deck. Similar to residential well pumps, the freshwater pump pressurizes the system to 45 psi. then shuts down until the pressure drops below that level. Most owners leave the pump “on” throughout the day, and use the system when necessary. On your 295DC, the freshwater pump feeds the pull out shower located on the aft transom wall, the head faucet, and the marine head. To view the layout of the water system see the drawing in section 10.4.6 thru 10.4.8.

10.1.5 Seacocks

OPEN



CLOSED



Ball valves (seacocks) are installed on the water intake for both the livewell and raw water system. The seacock must be in the open position for these systems to work. When open, the handle will be parallel to the valve. In the closed position the handle is perpendicular to the valve (see picture above). World Cat recommends that the seacocks remain in the closed position when not in use, or when the boat is left unattended to prevent the vessel from taking on water due to a plumbing failure.

10.1.6 Livewell System

Your 295DC has a 30 gallon livewell standard. It is equipped with a dual purpose livewell pump and adjustable flow regulator. The pump is located in the port bilge compartment and can be reached through the inspection port in the motorwell. The wiring is secured to the pump using a tie-strap, and must be disconnected prior to removing the pump.

The livewell pump draws water through the strainer mounted on the inboard side of the port sponson. A seacock is installed between the pickup and the pump to allow you to seal the system between use, or in the event of a plumbing failure. To operate the livewell, first verify that the seacock and flow regulator are open, then install the drain plug in the bottom of the tub. When you have completed these steps, engage the livewell pump using the switch at the dash. The livewell light is also controlled by the switch. Water will fill the tank until it is level with the overboard drain, which evacuates water through the hullside. To clear bait residue from the tank during operation, temporarily remove the drain plug. When you have finished using the livewell, remove the drain plug to allow the water to drain overboard.

NOTICE

While underway, leaving your livewell seacock open could result in inadvertently filling your livewell.

To prevent this, close the seacock when the pump is not in operation.

NOTICE

Operating the engines in reverse can cause excessive ventilation near the livewell intake, causing the pump to airlock. To prevent this, turn the pumps “OFF” prior to any continuous or high speed reverse operation. If your pump does become air locked, turn the pump “OFF” for 15 to 30 seconds to correct the problem.

10.1.7 Raw Water System

The raw water pump and associated wiring are found in the mechanical cabinet on the inboard wall of starboard seatbox. The pump is connected to a strainer mounted on the rigging wall in the starboard bilge compartment, which can be accessed through the motorwell hatch. The strainer is connected to a high speed pickup through the seacock located on the inboard side of the starboard sponson. The seacock must be open for the system to work. Similar to the freshwater pump, the raw water system is controlled by a pressure switch set at 45 psi. The pump will cycle on and off as needed to maintain this pressure. Most owners leave the pump “on” throughout the day, and use the system when necessary. On the 295DC, the raw water pump feeds the raw water outlet located on the starboard seatbox. To view the layout of the water system see the drawing in section 10.4.6 thru 10.4.7.

10.1.8 Marine Head

The 295DC comes equipped with a marine head. The control panel for the head, is located in the rigging space on the outboard vertical wall. Power is supplied to this panel through a 25 amp breaker located on the DC Sub Panel in the head compartment. The panel shown below controls the water level in the bowl and the discharge of waste from the head. Water is supplied to the system from the freshwater tank; therefore, to operate the toilet the freshwater system must be pressurized. A solenoid, installed near the head inlet, prevents water from filling the bowl prior to each use. The macerator pump, located at the rear of the toilet, removes waste from the bowl and pumps it into the 15 gallon holding tank.

!!! WARNING

If the solenoid fails or becomes locked in the open position, shut off the supply system quickly and evacuate the bowl.

The holding tank is mounted in the port hull forward of the gas tank, it can be accessed via the inspection plate or by removing the floor lid. This tank can be evacuated using the deck pump-out fitting located on the port side of the deck near the helm or by overboard discharge using the macerator pump and seacock supplied on your vessel. To access the seacock, open the inspection hatch installed in the port gunwale. Open the seacock and use the keyswitch on the head switch panel to evacuate the tank. To view the layout of the Marine Head system see the drawing in section 10.4.8

1.1.1.1. Initial Start Up

On each trip, prior to using the head, complete the following steps:

1. Turn on the freshwater system.
2. Fill 1/3 of the bowl with water using the lower switch on the control panel
3. Hold down the flush switch for 5 seconds to evacuate the bowl and refill with water.

1.1.1.2. Normal Use

Use the steps below for normal operation.

1. Hold the upper switch on the panel down for 5 seconds. This will purge the bowl and refill it with water.
2. In the event of inclement weather or rough seas, use the lower switch to remove water from the bowl and prevent sloshing.

!!! CAUTION

Large quantities of waste or paper can clog the head and cause odor issues. To prevent this, flush often and if necessary perform an extra flush to purge the discharge line.

!!! CAUTION

Do not dispose of foreign objects in the head. Doing so may damage the macerator pump or outlet hoses. Clogging or puncturing these lines will lead to odor problems.

1.1.1.3. Deck Pump Out

Upon returning, use the following instruction to empty the holding tank.

1. Remove the cap from the deck pump-out fitting located on deck, outboard of the helm position.
2. Use the vacuum hose at the pump-out station to clean the tank, then remove the hose and replace the deck fitting.

1.1.1.4. Overboard Discharge

Use the following steps to discharge the contents of the holding tank overboard:

1. Open the overboard discharge seacock. To access, open the inspection hatch installed inside the helm storage compartment.
2. Use the keyswitch located on the head switch panel to evacuate the tank.
3. Inspect the tank level and repeat step 2 if needed, otherwise close the discharge seacock.

!!! CAUTION

Discharging waste in inland waters and some coastal areas is illegal. Check with local and state authorities in your region to determine the proper method for waste disposal.

For more instructions on operation, winterization and troubleshooting the marine head, see the Jabsco™ manual supplied in your “Owner’s Portfolio”.

10.1.9 Anchor Windlass (Freefall)

World Cat provides an anchor windlass manufactured by Simpson Lawrence™. You will receive the windlass, an anchor, anchor rope, and chain which is matched to your vessel’s size. The rocker switch to control the windlass is mounted at the helm, and foot switches are installed at the windlass. The manufacturer’s instruction manual is provided, in the “Owner’s Portfolio”, detailing their use.

The circuit breaker for the anchor windlass is mounted on the breaker panel located in the head compartment. The panel is connected to the “Stbd Start” battery switch.

NOTICE

Windlasses used incorrectly could cause harm to equipment or crew. Windlasses should be used with care and treated with respect. Lewmar windlasses are designed and supplied for anchor control in marine applications and are not to be used in conjunction with any other use. It is the unaboidable responsibility of the owner or master or other responsible part to assess the risk of any operation on the vessel.

10.1.10 Windlass Deck Switch Maintenance

Refer to section 7.12 for details on maintenance provided by Lewmar

10.2 MAXIMUM HORSEPOWER RATING: TWIN 250 4-STROKE HP (500 HP TOTAL)

10.3 OPERATION OF OPTIONAL EQUIPMENT

10.3.1 Stereo

If chosen, your 295DC can be equipped with an optional stereo unit. The unit is mounted in the port head compartment. Two speakers are mounted in the forward bow area, and the remaining two are installed in the aft cockpit area. You can control the unit using the faceplate or the remote mounted on the dash. Power is supplied to the stereo through an accessory fuse block; therefore, the “house” battery switch must be in the “on” position to use the unit.

10.3.2 Outriggers

Outriggers enhance the fishability of your catamaran and can be a great asset when hunting a trophy catch. World Cat offers Taco™ outriggers as an option. The units are mounted on the fiberglass hardtop and operated using the handles above and outboard of the walkthrough. Use the information provided in section 7.6 to maintain the aluminum on the outriggers and grease the telescoping joints frequently to prevent damage from salt spray.

10.3.3 Battery Charger

Combined with the battery management system, this system helps ensure that your vessel will be ready to fish whenever you are. The charger is located on the bulkhead aft of the batteries, to access open the hatch located over the batteries in the helm storage compartment.

10.4 SYSTEM DIAGRAMS

10.4.1 Access Plate and Rigging Tube Diagram

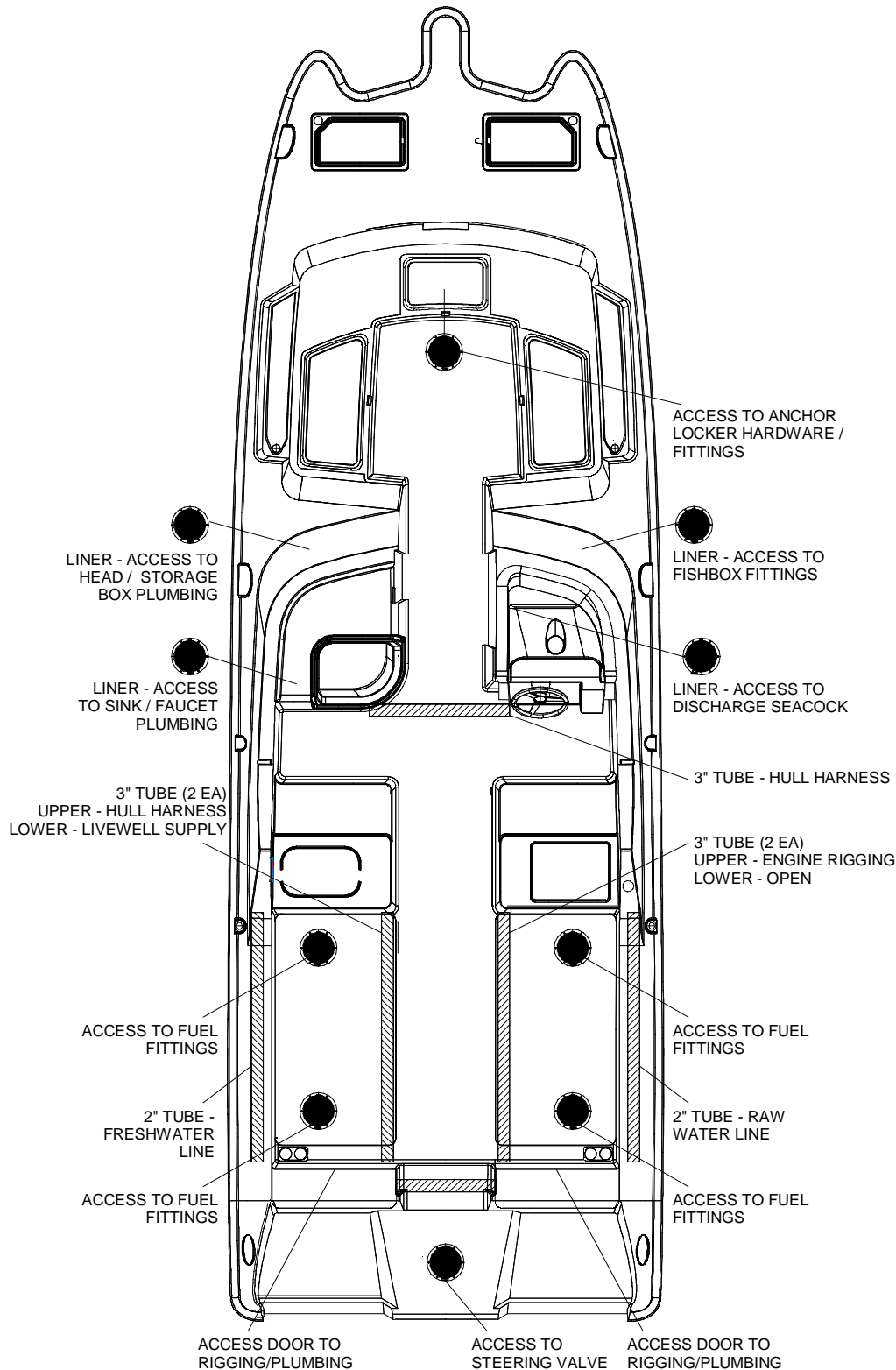

10.4.2 Wire Code

295DC Wire Code				
FUNCTION	COLOR	GAUGE	BREAKER/FUSE AMPS	BREAKER/FUSE LOCATION
Switch Cluster	Red	#10	30A Fuse	Dash Panel Fuse Block
Console 12V	Red	#12	20A Fuse	Dash Panel Fuse Block
Switch Cluster	Red	#10	30A Fuse	Dash Panel Fuse Block
Head Lighting	Blue	#14	5A Fuse	Dash Panel Fuse Block
Sbd C-pit Outlet	Red	#10	20A Fuse	Dash Panel Fuse Block
Work Light	Blue	#16	5A Fuse	Dash Panel Fuse Block
Wiper System	Red	#14	10A Fuse	Dash Panel Fuse Block
Refrigerator	Red	#14	4A Fuse	Dash Panel Fuse Block
Storage Light	Blue	#14	5A Fuse	Dash Panel Fuse Block
Stereo	Purple/Red	#14	1A Fuse	Dash Panel Fuse Block
Tank Monitor	Red	#16	1A Fuse	Dash Panel Fuse Block
Horn	Orange	#14	10A Breaker	Switch Panel
Nav lights	Grey/White	#14	5A Breaker	Switch Panel
Anchor light	Grey	#14	5A Breaker	Switch Panel
Cockpit lights	Blue	#14	10A Breaker	Switch Panel
Livewell Pump	Brown	#12	5A Breaker	Switch Panel
Fresh Water Pump	Brown	#12	15A Breaker	Switch Panel
Raw Water Pump	Brown	#12	15A Breaker	Switch Panel
ACCY 1	Open	NA	5A Breaker	Switch Panel
ACCY 2	Open	NA	5A Breaker	Switch Panel
Windlass	Red	#14	5A Breaker	Switch Panel
Head Macerator	Brown	#12	20A Breaker	Switch Panel
Winch	Red	#6	50A Breaker	Head Sub Panel
Hardtop Power	Red	#6	25A Breaker	Head Sub Panel
Head	White/Red	#10	25A Breaker	Head Sub Panel
DC Outlets	Red	#10	20A Breaker	Head Sub Panel
Stereo Memory	White/Yellow	#14	10A Breaker	Battery Management Panel
ACCY	Open	#14	10A Breaker	Battery Management Panel
Port Aft Float Switch	Brown	#14	10A Breaker	Battery Management Panel
Sbd Aft Float Switch	Brown	#14	10A Breaker	Battery Management Panel
Tank Monitor	Red	#14	3A Breaker	Battery Management Panel
DC Main 1	Red	#6	50A Breaker	Battery Management Panel
DC Main 2	Red	#6	50A Breaker	Battery Management Panel

10.4.3 Hull Wiring Diagram

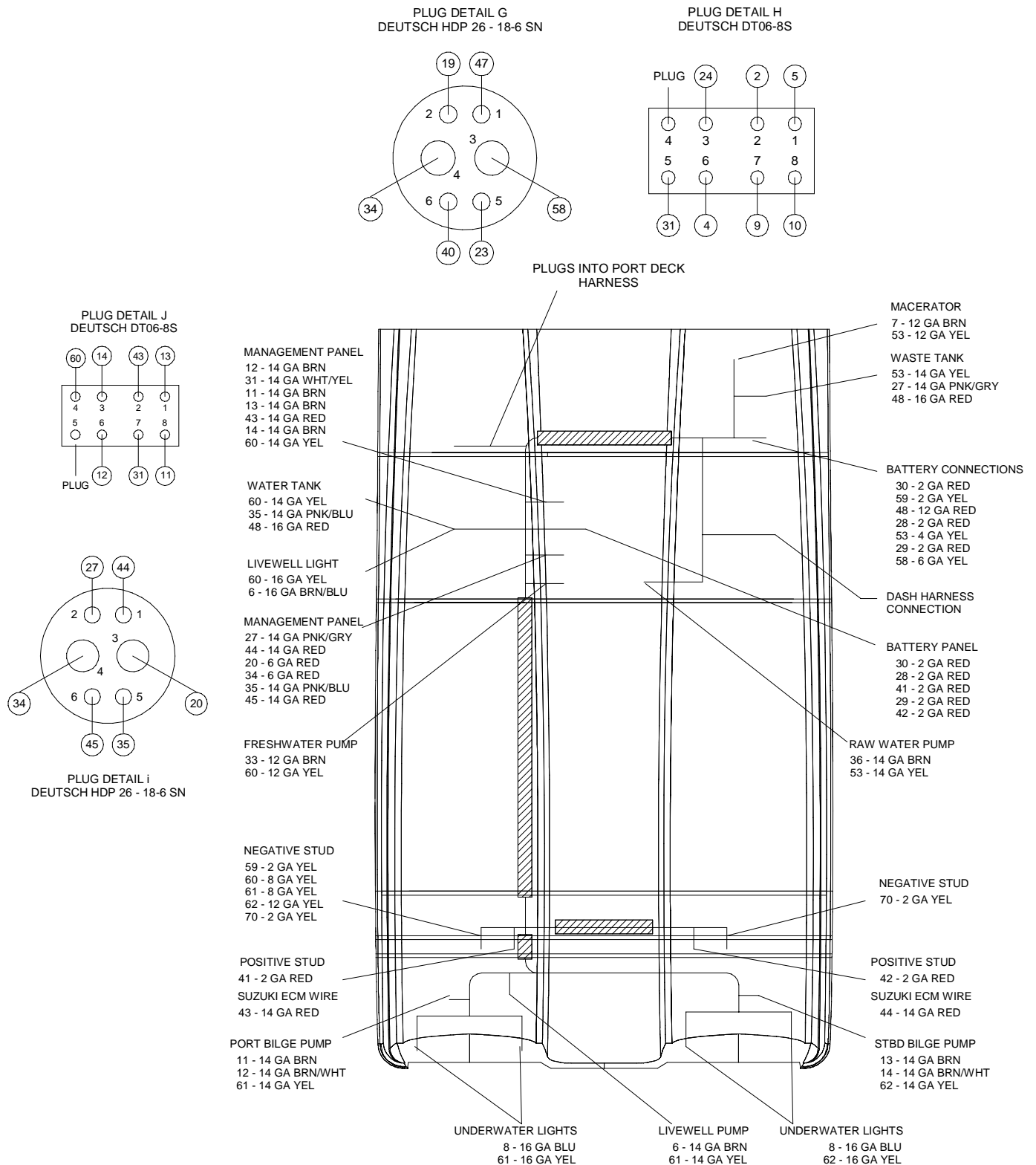

10.4.4 Starboard Deck Wiring Diagram

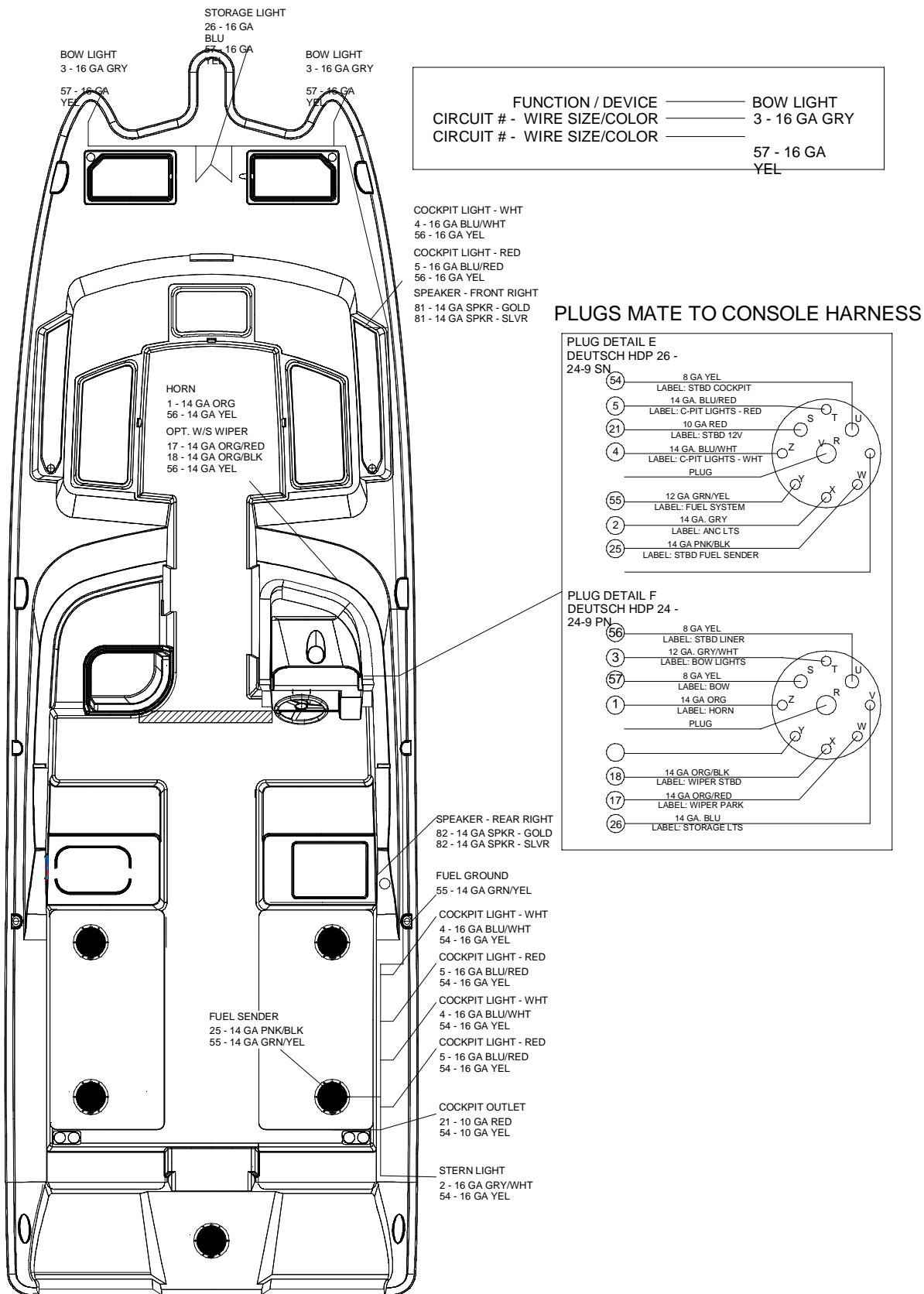

10.4.5 Port Deck Wiring Diagram

FUNCTION / DEVICE	—————	BOW LIGHT
CIRCUIT # - WIRE SIZE/COLOR	—————	3 - 16 GA GRY
CIRCUIT # - WIRE SIZE/COLOR	—————	57 - 16 GA YEL

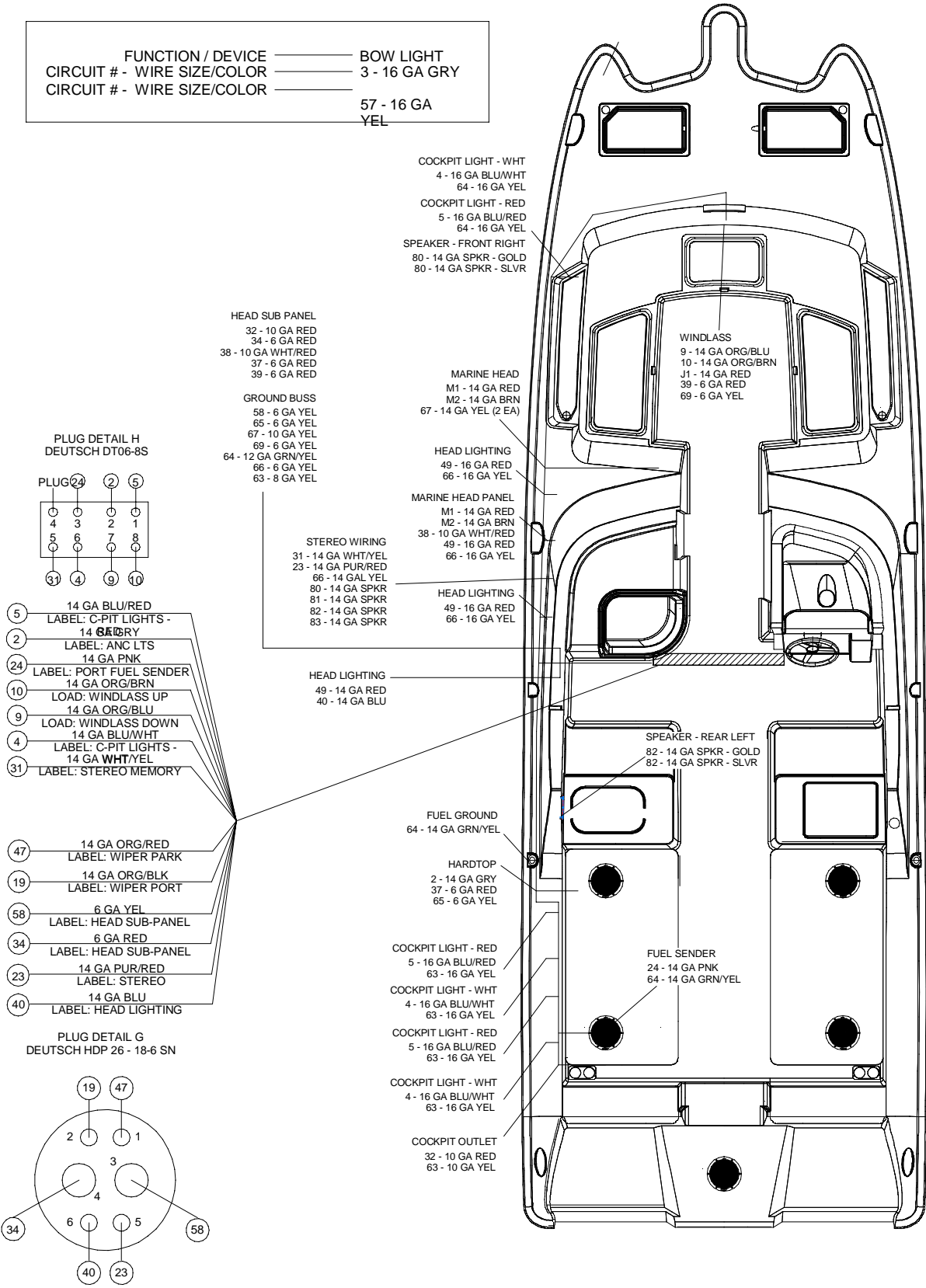

COCKPIT LIGHT - WHT
4 - 16 GA BLU/WHT
64 - 16 GA YEL

COCKPIT LIGHT - RED
5 - 16 GA BLU/RED
64 - 16 GA YEL

SPEAKER - FRONT RIGHT
80 - 14 GA SPKR - GOLD
80 - 14 GA SPKR - SLVR

HEAD SUB PANEL
32 - 10 GA RED
34 - 6 GA RED
38 - 10 GA WHT/RED
37 - 6 GA RED
39 - 6 GA RED

GROUND BUSS
58 - 6 GA YEL
65 - 6 GA YEL
67 - 10 GA YEL
69 - 6 GA YEL
64 - 12 GA GRN/YEL
66 - 6 GA YEL
63 - 8 GA YEL

PLUG DETAIL H
DEUTSCH DT06-8S

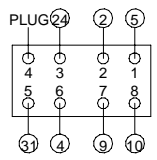

- 5 14 GA BLU/RED LABEL: C-PIT LIGHTS - 14 GA RED
- 2 LABEL: ANC LTS 14 GA PNK
- 24 LABEL: PORT FUEL SENDER 14 GA ORG/BRN
- 10 LOAD: WINDLASS UP 14 GA ORG/BLU
- 9 LOAD: WINDLASS DOWN 14 GA BLU/WHT
- 4 LABEL: C-PIT LIGHTS - 14 GA WHT/YEL
- 31 LABEL: STEREO MEMORY

- 47 14 GA ORG/RED LABEL: WIPER PARK
- 19 14 GA ORG/BLK LABEL: WIPER PORT
- 58 6 GA YEL LABEL: HEAD SUB-PANEL
- 34 6 GA RED LABEL: HEAD SUB-PANEL
- 23 14 GA PUR/RED LABEL: STEREO
- 40 14 GA BLU LABEL: HEAD LIGHTING

PLUG DETAIL G
DEUTSCH HDP 26 - 18-6 SN

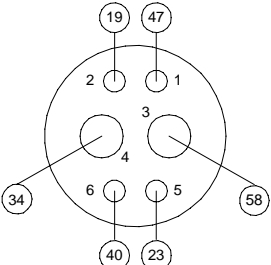

MARINE HEAD
M1 - 14 GA RED
M2 - 14 GA BRN
67 - 14 GA YEL (2 EA)

HEAD LIGHTING
49 - 16 GA RED
66 - 16 GA YEL

MARINE HEAD PANEL
M1 - 14 GA RED
M2 - 14 GA BRN
38 - 10 GA WHT/RED
49 - 16 GA RED
66 - 16 GA YEL

STEREO WIRING
31 - 14 GA WHT/YEL
23 - 14 GA PUR/RED
66 - 14 GA YEL
80 - 14 GA SPKR
81 - 14 GA SPKR
82 - 14 GA SPKR
83 - 14 GA SPKR

HEAD LIGHTING
49 - 14 GA RED
40 - 14 GA BLU

SPEAKER - REAR LEFT
82 - 14 GA SPKR - GOLD
82 - 14 GA SPKR - SLVR

FUEL GROUND
64 - 14 GA GRN/YEL

HARDTOP
2 - 14 GA GRY
37 - 6 GA RED
65 - 6 GA YEL

COCKPIT LIGHT - RED
5 - 16 GA BLU/RED
63 - 16 GA YEL

COCKPIT LIGHT - WHT
4 - 16 GA BLU/WHT
63 - 16 GA YEL

COCKPIT LIGHT - RED
5 - 16 GA BLU/RED
63 - 16 GA YEL

COCKPIT LIGHT - WHT
4 - 16 GA BLU/WHT
63 - 16 GA YEL

COCKPIT OUTLET
32 - 10 GA RED
63 - 10 GA YEL

WINDLASS
9 - 14 GA ORG/BLU
10 - 14 GA ORG/BRN
J1 - 14 GA RED
39 - 6 GA RED
69 - 6 GA YEL

FUEL SENDER
24 - 14 GA PNK
64 - 14 GA GRN/YEL

10.4.6 Freshwater System Diagram

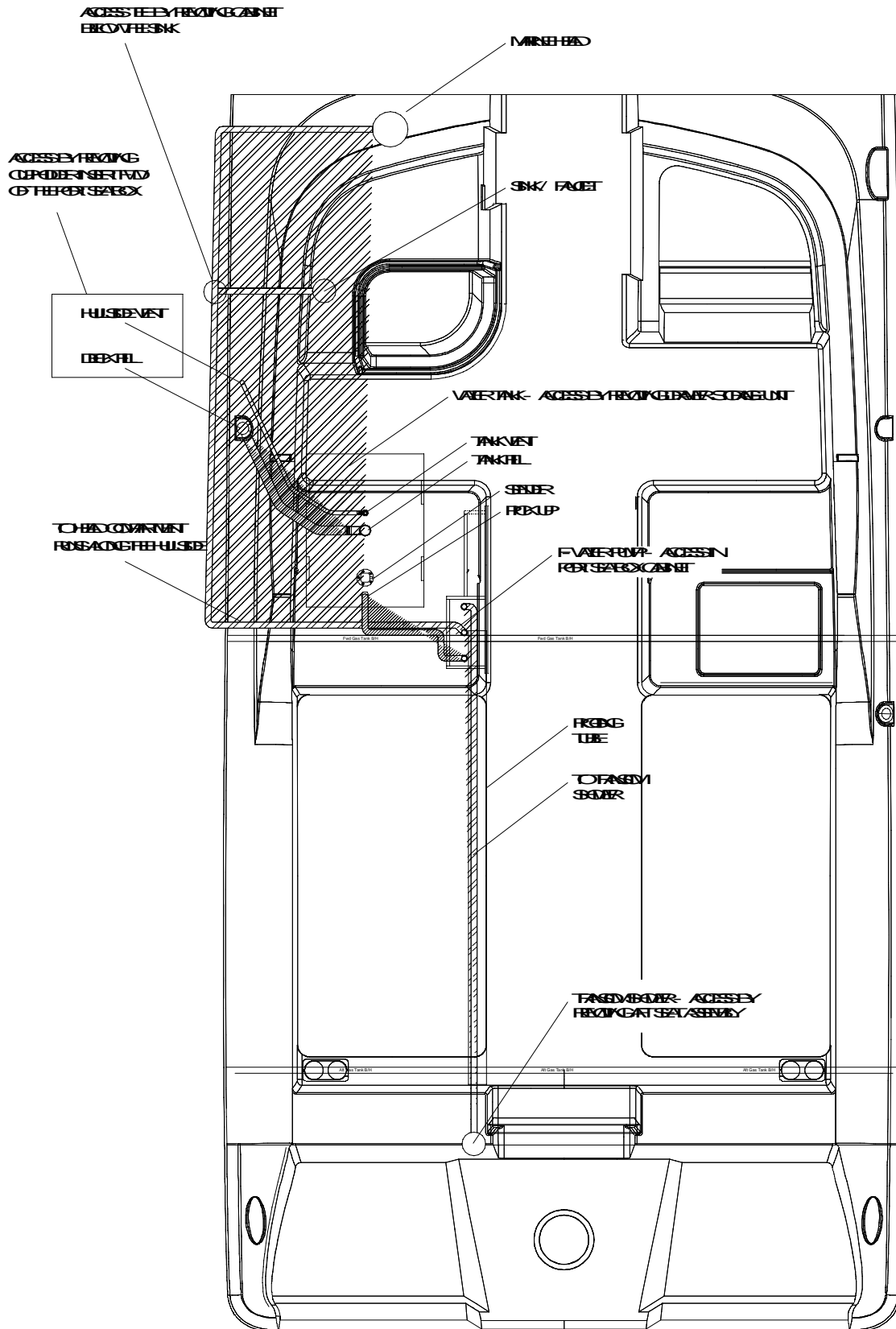

10.4.7 Livewell / Raw Water System

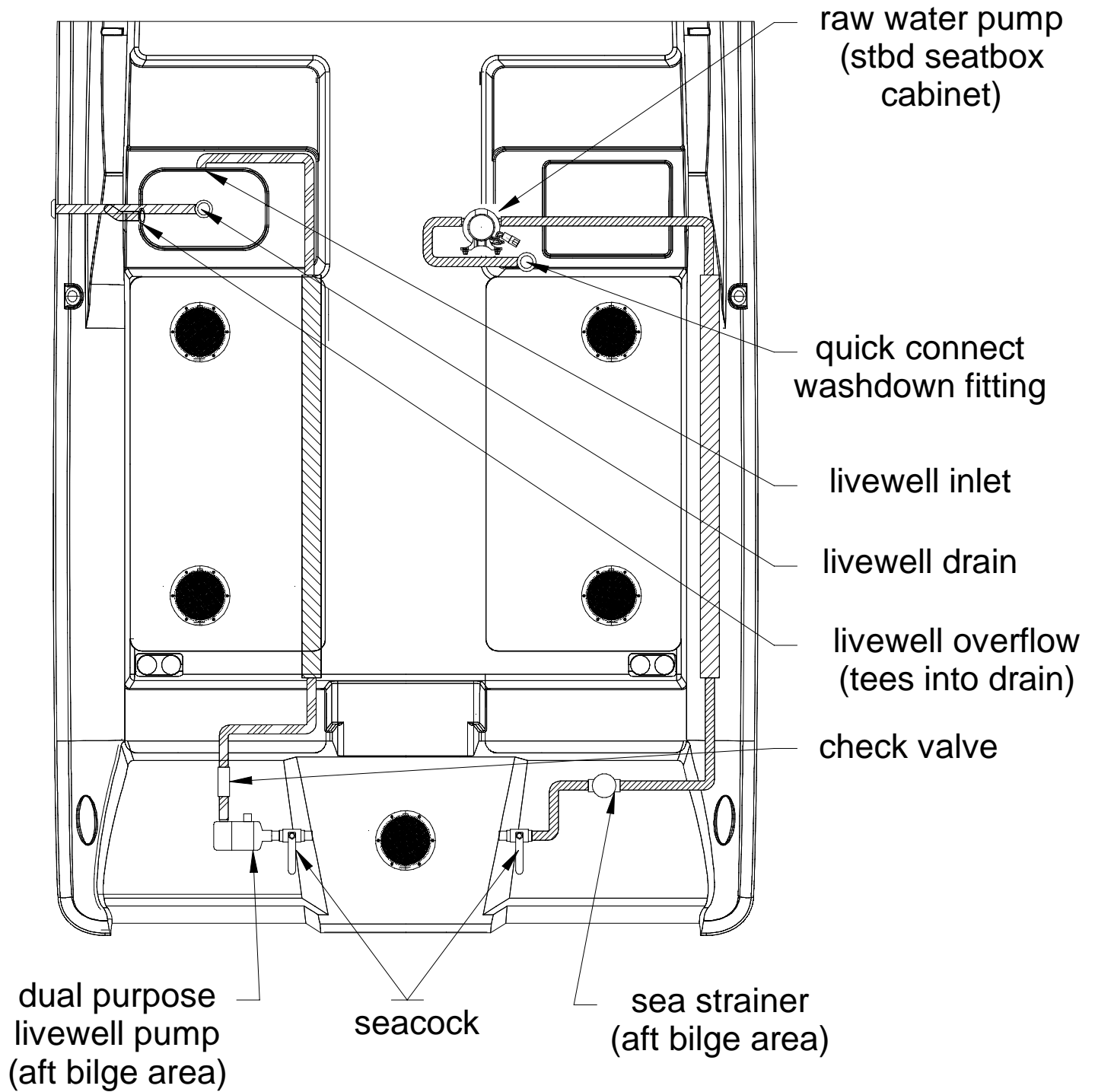

10.4.8 Marine Head Diagram

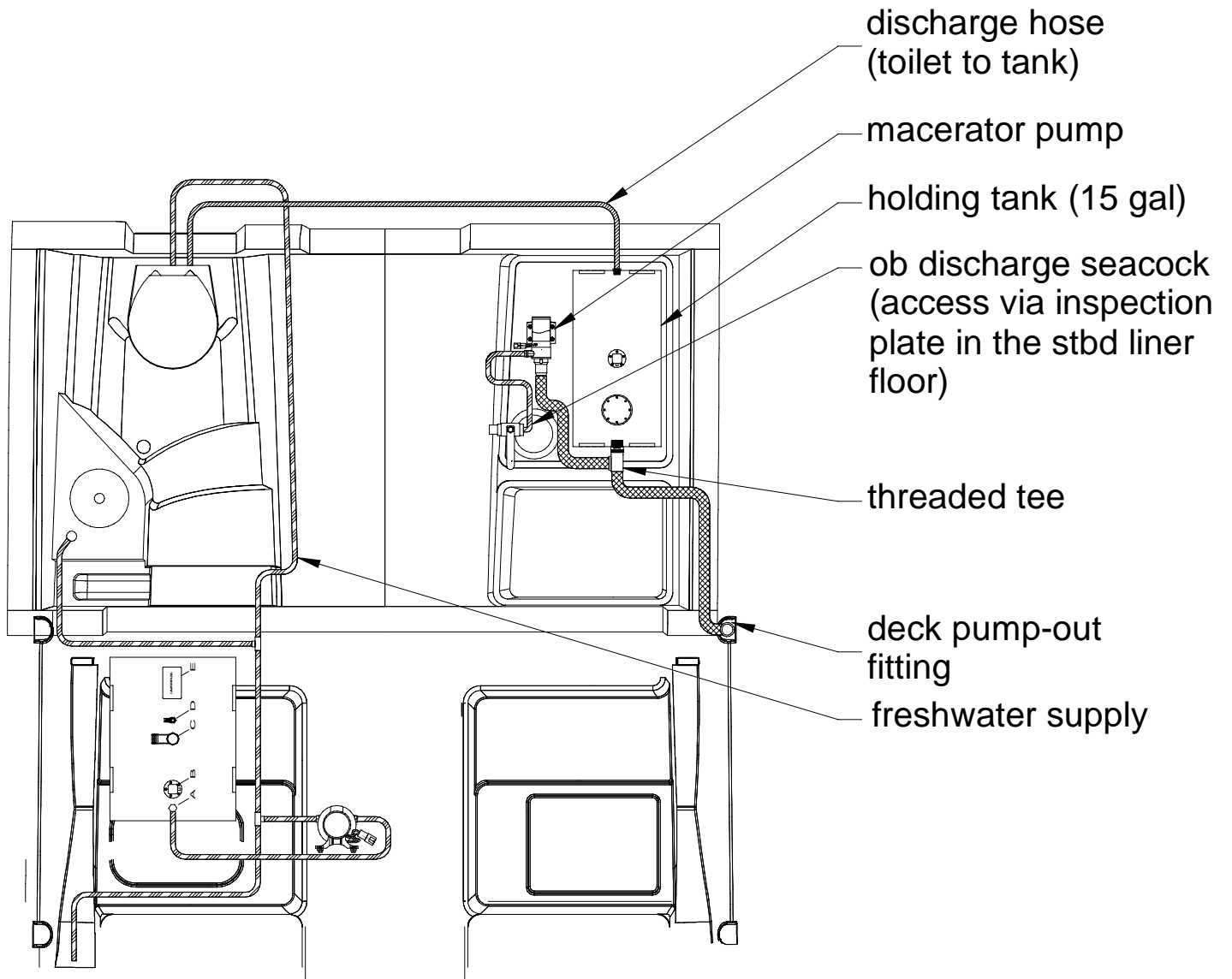

10.4.9 Thru-Hull Diagram

T-HULL	DESCRIPTION	SIZE	PART #	QTY
A	AFT BILGE PUMP	1-1/8" (90°)	20163452	2
B	SCUPPER DRAINS	1-1/2"	20163457	2
C	SCUPPER DRAINS	1-1/2"	20163457	2
D	LIVWELL DRAIN	1-1/2"	20163456	1
E	HELM FLOOR DRAIN	3/4"	20163454	2
F	WATER TANK VENT	5/8" (90°)	20160504	1
G	HEAD SINK DRAIN	3/4"	20163454	1
H	FORWARD BOX DRAIN - PORT	3/4"	20163454	1
I	ANCHOR LOCKER DRAIN	1-1/8"	20163455	2
J	AFT FISHBOX DRAIN	1-1/8"	20163455	1
K	HOLDING TANK VENT	5/8" (90)	20160504	1
L	FORWARD BOX DRAIN-STARBOARD	1-1/8"	20163455	1
M	GARBOARD DRAIN	n/a	20150225	1

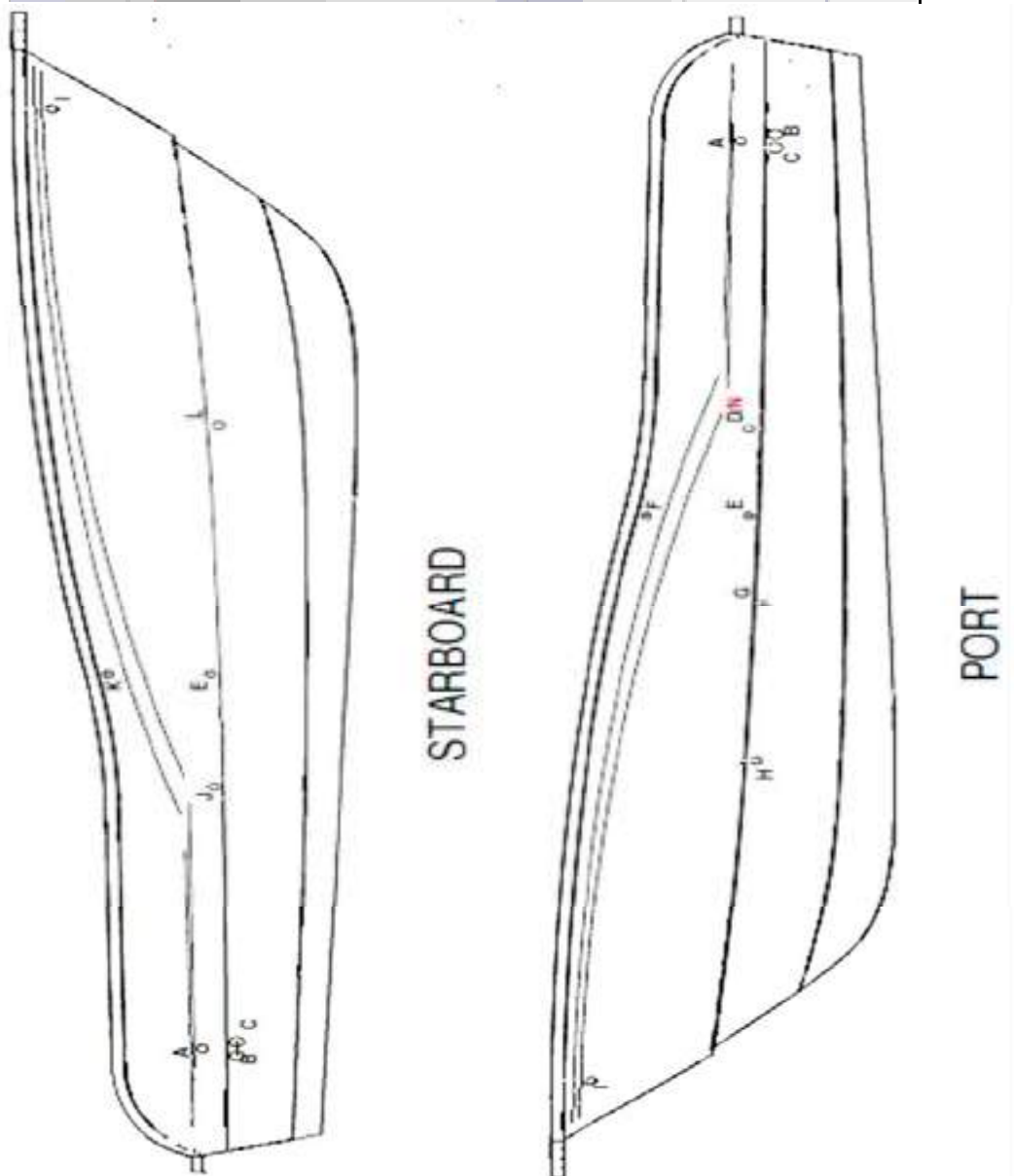









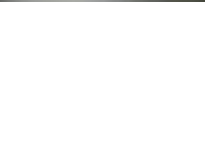

2015 295DC Spare Parts List

Service Class	Part Number	Description
Electrical & Lighting		
	20190123	12VDC Outlet for Downriggers
	20170274	12VDC Outlet for Lighter Plug
	20190139	12VDC Receptacle Mounting Plate
	20190138	12VDC Receptacle Plug Troll MTR, Plug Bulk
	20190372	290DC Common Ground Jumper (CUSTOM)
	20300383	290DC Instrument Panel Assy (Pacer 2013MY)
	20300305	290DC Radio Box Panel Assy (REV-1)
	20171467	290DC Sub Panel (360 DC 1x1 Panel/4 Switch)
	20173484	295DC Battery Management Panel (2014MY-Pacer)
	20170902	Accessory Switch Assy
	20200297	Atwood LED Mast Light (24") - S/S Base











These parts should be installed by a certified World Cat dealer. Installation by a non-authorized 3rd party may result in improper enforcement and create safety concerns. Please contact your local, authorized, World Cat dealer to buy these parts at the same price.

Price and availability subject to change.

Service Class	Part Number	Description
	20156841	Battery Tray (Group 27) - Narrow Width - S/S Rods
	20150379	Battery Tray (Group 31) - Narrow Width - S/S Rods
	20170277	BEP Negative Buss Bar HD (300A/4-Pole)
	20190177	BEP Positive Stud
	20173489	Bluetooth Dongle - Sirius Input (Fusion Stereo)
	20170220	Cabin Light
	20173416	Coastal Plus Wiper Motor 2 1/2" Shaft
	20151493	Day/Night (3" Rnd) White - w/Battery Backup Solar Mini-Vent
	20170335	Deka Battery (Group 31/Std)-House (DP31DT)
	20170360	Dual Direction Ctrl 12V (PM)
	20173490	Fusion Marine 700 Series Internal Ipod ReceiverN2K (w/Amphenol Connector)

These parts should be installed by a certified World Cat dealer. Installation by a non-authorized 3rd party may result in improper enforcement and create safety concerns. Please contact your local, authorized, World Cat dealer to buy these parts at the same price.

Price and availability subject to change.

Service Class	Part Number	Description
	20173501	Fusion Stereo Remote
	20200298	Hardtop LED Light w/ Driver (P/C Bezel)
	20173510	JL Audio 6.5 Speaker (Titanium w/ Sport Grill)
	20200283	LED Bow Lights (PR)
	20200272	LED Cockpit Light
	20200274	LED Cockpit Light Trim Ring
	20200273	LED Livewell Light - Red
	20200273	LED Livewell Light - Red
	20200291	LED Overhead Light (2.75")
	20200292	LED Overhead Light (4")
	20200287	LED Storage Light

These parts should be installed by a certified World Cat dealer. Installation by a non-authorized 3rd party may result in improper enforcement and create safety concerns. Please contact your local, authorized, World Cat dealer to buy these parts at the same price.

Price and availability subject to change.

Service Class	Part Number	Description
	20170371	Lewmar ProFish 700 Windlass - Freefall
	20170874	Lewmar Windlass Up/Down Foot Switches (Black)
	20200286	Pole Light Base, Black SS w/ Locking Collar (2-Pin Light)
	20173426	ProSport 20 Plus 3-Bank Waterproof Charger (20A, 50/60Hz 90-135VAC)
	20150382	PSPT AC Plug Holder w/ Clamp
	20200300	Replacement Bezel - Powder Coat for part # APL-174L-SDI-51
	20170913	Ritchie Compass (Small Profile)
	20150888	SF/290DC Electrical Enclosure
	20173431	Sony AM/FM Antenna w/ Amp
	20173430	Sony AUX35USBCP Aux/USB Input
	20173428	Sony CDXH910U Stereo Receiver

These parts should be installed by a certified World Cat dealer. Installation by a non-authorized 3rd party may result in improper enforcement and create safety concerns. Please contact your local, authorized, World Cat dealer to buy these parts at the same price.

Price and availability subject to change.

Service Class	Part Number	Description
	20173432	Sony RMX60M Digital Remote
	20173429	Sony XSMP1611 Speaker (6.5 Coax - White)
	20200277	Spreader Light (Flush Mount)
	20200294	Storage Light Base (use w/ 20200287)
	20200357	Vimar 1M Faceplate (Chrome)
	20200356	Vimar On - Off Switch
	20170911	Wiper Controls Backing Plate
	20170880	Wiper Fluid Reservoir (4 liter)
	90440525	Yamaha F250/F350 Main Engine Harness
Fiberglass		
	20130006	Laminated Anchor Locker Lid (230SF,250SF/DC,290,320)
	26000324	Laminated Deck Cap-Port (290DC)









These parts should be installed by a certified World Cat dealer. Installation by a non-authorized 3rd party may result in improper enforcement and create safety concerns. Please contact your local, authorized, World Cat dealer to buy these parts at the same price.

Price and availability subject to change.

Service Class	Part Number	Description
	26000325	Laminated Deck Cap-Stbd (290DC)
	26003607	Laminated Deck Plate - World Cat White (8" x 10")
	26000320	Laminated Forward Seat Lid Port (290DC)
	26003608	Laminated Gas Tank Lid (P/S) (290DC EPA 2014MY)
	26000369	Laminated Head Door - Outer (290DC)
	26000251	Laminated WC White Swim Platform Floor
Fuel System		
	20160328	1/4 PT X 3/8 HB, Brass 90 deg.
	20161408	2640 Gas Tank Bracket-Lower (13")
	20161409	2640 Gas Tank Bracket-Upper (20")
	20220083	Attwood FDV Fuel Demand Value (No-Antisiphon)
	20163465	Attwood Inlet Control Valve (EPA Diurnal)

These parts should be installed by a certified World Cat dealer. Installation by a non-authorized 3rd party may result in improper enforcement and create safety concerns. Please contact your local, authorized, World Cat dealer to buy these parts at the same price.

Price and availability subject to change.

Service Class	Part Number	Description
	20163488	Attwood Pressure Relief Deck Gas Fill (Straight Zamak/Chrome)
	20140102	Fuel Hose 1 1/2" (50'/RL)
	20140103	Fuel Hose 3/8" (250'/RL)
	20140104	Fuel Hose 5/8" (250'/RL)
	20160504	Fuel Tank Vent 90 deg - Flush Mount 5/8"
	20220101	Gas Tank 125 Gal (Low Perm Pressurized)
	20220039	Tank Hold Down Brackets (Inca J-Hooks)
	90441543	Yamaha Fuel Filter/Water Separator
Gel coat	20040120	Gel Ext Ashland "Aqua Mist" (Awlgrip H4365 Match) (16052913) (DR838)
	20040132	Gel Ext Ashland "Platinum" (RAL-7040 Window Gray) (16052917) (DR838)
	20040037	Gel Ext Ashland "World Cat Exterior" (164922)

These parts should be installed by a certified World Cat dealer. Installation by a non-authorized 3rd party may result in improper enforcement and create safety concerns. Please contact your local, authorized, World Cat dealer to buy these parts at the same price.

Price and availability subject to change.

Service Class	Part Number	Description
	20040037	Gel Ext Ashland "World Cat Exterior" (164922)
	20040098	Gel Ext Ashland NCP "Sapphire Blue" (RAL-5003) (16052915) (DR838)
	20040128	Gel Ext Ashland NRP "Ice Blue" (Sea Hunt Match) (16052912) (DR838)
	20040128	Gel Ext Ashland NRP "Ice Blue" (Sea Hunt Match) (16052912) (DR838)
	20040090	Gel Int Ashland "SR Arctic White" Gel (11 Series)

Graphic & Logos



20690362 Battery Management Label



20690359 Fire Extinguisher Sticker



20600229 NMMA Yacht Plate (World Cat)



20690484 PowerCat Group RTM Coverup (Crystal Cap Foam Backed, 1.5 x 2.25)



20690361 Raw Water Sticker



20690345 Vectorflo Graphic

These parts should be installed by a certified World Cat dealer. Installation by a non-authorized 3rd party may result in improper enforcement and create safety concerns. Please contact your local, authorized, World Cat dealer to buy these parts at the same price.

Price and availability subject to change.

Service Class	Part Number	Description
	60690302	Warning Label - Prop Helm
	60690301	Warning Label - Prop Transom
	20690331	World Cat "S/S" Hullside Logo (Chrome 3.15" x 26")
Hardware- Deck		
	20160486	1 1/2" Painted Cap
	20150232	12" Handrail W/ Studs, S/S Part
	20700279	24" Folddown Stern Seat Frame (290's/320EC)
	20150926	290 Port Transom Cover
	20150927	290 Stbd Transom Cover
	20610400	290 World Cat Aft Pre-Bent (Port) - Taco CRB/304 SS
	20610401	290 World Cat Aft Pre-Bent (Stbd) - Taco CRB/304 SS
	20156961	290, 320 Transom Door (ST Starboard, World Cat)

These parts should be installed by a certified World Cat dealer. Installation by a non-authorized 3rd party may result in improper enforcement and create safety concerns. Please contact your local, authorized, World Cat dealer to buy these parts at the same price.

Price and availability subject to change.

Service Class	Part Number	Description
	20151036	290/320 Bow Table (Seafoam)
	20150936	290DC Battery Closeout Lid
	20160522	290DC Bow Handrail - Port
	20160523	290DC Bow Handrail - Stbd
	20151033	290DC Drawer Storage Unit
	20151033	290DC Drawer Storage Unit
	20300310	290DC Gauge Panel - Yam/Suz
	20151039	290DC Helm Footrest
	20151047	290DC Mirror (9" x 15")
	20151110	290DC Port Countertop w/ Sink and Cutting Board - Ent Option
	20151017	290DC Rod Locker Closeout









These parts should be installed by a certified World Cat dealer. Installation by a non-authorized 3rd party may result in improper enforcement and create safety concerns. Please contact your local, authorized, World Cat dealer to buy these parts at the same price.

Price and availability subject to change.

Service Class	Part Number	Description
	20150938	290DC Rod Locker Door
	20151019	290DC Rod Locker Racks
	20151022	290DC Rope Locker Cabinet
	20151108	290DC Storage Cabinet - Ent Option
	20150935	290DC Storage Liner Lid
	**20156981	290DC Tackle Box Unit (NEW PART) 3/28/2013
	20151037	290DC Vanity Cabinet
	20151018	290DC Windlass Closeout
	20151013	290DC/EC Countertop Assy
	20510940	295DC Anodized Aluminum Hardtop Frame (2014MY)
	20510940	295DC Anodized Aluminum Hardtop Frame (2014MY)

These parts should be installed by a certified World Cat dealer. Installation by a non-authorized 3rd party may result in improper enforcement and create safety concerns. Please contact your local, authorized, World Cat dealer to buy these parts at the same price.

Price and availability subject to change.

Service Class	Part Number	Description
	20510943	295DC Hardtop Storage Net Tan (New Part)
	20310301	295DC Powder Coated 5-Piece Windshield (RAL-9001) (2014)
	20157021	295DC Std Battery Panel Cabinet - Starboard Face (2014MY) (holds 20173484)
	20157021	295DC Std Battery Panel Cabinet - Starboard Face (2014MY) (holds 20173484)
	20157024	295DC Windshield Closeout Door (New Part)
	20160229	3" Cable Boot, Off White
	20160329	3" White Trim Ring (Chaffing Ring)
	20160231	3/8" Plastic Drain
	20160330	4" White Trim Ring (Chaffing Ring)
	20163444	4.5" Cable Boot - Black
	20160241	5" Straight Chock for Pulpit

These parts should be installed by a certified World Cat dealer. Installation by a non-authorized 3rd party may result in improper performance and create safety concerns. Please contact your local, authorized, World Cat dealer to buy these parts at the same price.

Price and availability subject to change.

Service Class	Part Number	Description
	20163550	8" Cutting Edge sleek pull up cleat
	20160470	Adjustable Windshield Brace (8 1/2"-10 1/2")
	20160541	Aft Seat Mounting Plates
	20210266	Aluminum Cushioned Clamps (3/4")
	20150333	Anchor Rode Special 8-Plaited Anchor Rope (2005)
	20150332	Anchor Safety Strap (2005)
	20160323	Armstrong Square Motorwell Plate (10" x 20" Rect) - Off White WC
	20163486	ASI Bracket for Gas Shocks
	20163485	ASI S/S Flat Bracket for Gas Shocks w/10MM
	20160269	Barrel Bolt for TE Transom Door
	20157027	Barrel Bolt Spacer (295DC Windshield Closeout Door)











These parts should be installed by a certified World Cat dealer. Installation by a non-authorized 3rd party may result in improper enforcement and create safety concerns. Please contact your local, authorized, World Cat dealer to buy these parts at the same price.

Price and availability subject to change.

Service Class	Part Number	Description
	W7010057	Bottom H Section of Seat (290's/320EC-24" Folddown Stern Seat)
	20150235	Bow Roller
	20153405	Bow Table Storage Unit 290 (Seafoam) WC
	20150361	Cabin Cockpit Floor Base Cap
	20150359	Cabin Cockpit Floor Base, 5" (for Table)
	20150360	Cabin Cockpit Table Base
	20150353	Cabin Cockpit Table Post 27"
	20140107	Clear Hose 3/8" (200'/RL)
	20150931	Cockpit Storage Unit - Port (290DC, 290CC, 290EC, 320CC)
	20150932	Cockpit Storage Unit - Stbd (290DC, 290CC, 290EC, 320CC)
	20600240	Color Match 304SS & Vinyl Bow (WC 290)

These parts should be installed by a certified World Cat dealer. Installation by a non-authorized 3rd party may result in improper enforcement and create safety concerns. Please contact your local, authorized, World Cat dealer to buy these parts at the same price.

Price and availability subject to change.

Service Class	Part Number	Description
	20160169	Drain Plate Stainless Steel Cockpit Area
	20430001	Draw Latch (Small Rubber 4.16")
	20160477	Draw Latch Keeper
	26500443	Faucet - Single Lever/Cold H2O (2740/2770)
	**26500443	Faucet - Single Lever/Cold H2O (2740/2770)
	20150937	Fire Extinguisher Cabinet - Port (290DC/320CC)
	20150939	Fire Extinguisher Cabinet - Stbd (290DC, 290CC, 320CC)
	20700311	Folding Footrest (255DC/290DC)
	20700311	Folding Footrest (255DC/290DC)
	20163466	Gas Shock 12" Ext. Length, 30lb, 316SS w/ Composite End
	20163469	Gas Shock 17" Ext. Length, 30lb, 316SS w/ Composite Ends

These parts should be installed by a certified World Cat dealer. Installation by a non-authorized 3rd party may result in improper enforcement and create safety concerns. Please contact your local, authorized, World Cat dealer to buy these parts at the same price.

Price and availability subject to change.

Service Class	Part Number	Description
	20163470	Gas Shock 7.5" Ext. Length, 20lb, 316SS w/ Composite Ends
	20160275	GEM S/S Lift Handle Latch Lock 3"
	20151104	Grill Mounts (Magma Newport)
	20160703	Hinge 2" x 3" Anchor Lid Style
	20160363	Holder Magnetic Window 316SS 30 x 15 Strike
	20163472	IPS 4" Access Plate (Dream White - World Cat)
	20163473	IPS 6" Access Plate (Dream White - World Cat)
	20163474	IPS 8" Access Plate (Dream White - World Cat)
	20150311	Large Anchor 22lb
	20160016	Latch Cam for 250DC/23DC
	20150889	Leanbar Drink Holder Insert (Offwhite)

These parts should be installed by a certified World Cat dealer. Installation by a non-authorized 3rd party may result in improper enforcement and create safety concerns. Please contact your local, authorized, World Cat dealer to buy these parts at the same price.

Price and availability subject to change.

Service Class	Part Number	Description
	20160465	Lid Lock Spacer 2"-Black
	20160357	Magnetic Door Holder (Proud/Flush)
	W7010083	Magnetice for E-Box Hardtop 29DC/33TE
	20151103	Marine LP Grill (Magma Newport Gourmet Series)
	20500273	Mesh Carrying Bag For A Pair Of Outriggers
	20100280	Mildew Resistant Silicone (Almond)
	26500438	Mirror Holder 4pc Kit w/ Screws & Anchors Hillman Number
	20160124	Neoprene .25" thick Gasket Material Cut in 2" sections (10FT/EA)
	28130284	Outrigger Backing Plates (2/SET)
	28130278	Pair of Taco Outrigger Poles 18' Silver w/ Gold
	20160488	Pedestal Base Inserts (Seafoam HDPE) Rev-1





These parts should be installed by a certified World Cat dealer. Installation by a non-authorized 3rd party may result in improper enforcement and create safety concerns. Please contact your local, authorized, World Cat dealer to buy these parts at the same price.

Price and availability subject to change.

Service Class	Part Number	Description
	20160488	Pedestal Base Inserts (Seafoam HDPE) Rev-1
	20151038	Pedestal Storage Clips
	20160121	Piano Hinge (1.75"W/050) - 11.5"
	20163413	Piano Hinge (2.5" x 25.5")
	20151111	Propane Canister Cabinet - Seafoam (Worldcat) 290DC
	20163542	Push to Close Latch, Slide (Non-Magnet)
	20160343	Rigging 2" Flange w/ Fuel Hose Port-Black
	20160344	Rigging Flange Hose Union (Black)
	20140123	Rigging Hose-Black 2" (50'/RL)
	20500274	Rigging Kit Premium Black Cord Trip Ese
	20150259	Rod Holder Grommet (3 3/8")







These parts should be installed by a certified World Cat dealer. Installation by a non-authorized 3rd party may result in improper enforcement and create safety concerns. Please contact your local, authorized, World Cat dealer to buy these parts at the same price.

Price and availability subject to change.

Service Class	Part Number	Description
	20150252	Rub Rail Insert - Bendable 304 S/S (16' EA)
	20610259	Rub Rail Off-White (20ft) (World Cat)
	20163509	S/S 0° Rod Holder (Cast Head, Formed Tube w/ Drain)
	20156871	S/S 2-Step Cup Holder w/ Drain (92mm)
	20156871	S/S 2-Step Cup Holder w/ Drain (92mm)
	20163391	S/S 30° Rod Holder (Cast Head, Formed Tube w/ Drain)
	60233231	Safety Walk 12" x 60' Black (60FT/RL) 60sqft per roll
	20163498	Speaker Cutout Cover (WC)
	20170254	Stainless FIAM Horn
	20150292	Starboard Large Hatch (14x23) (290DC, 290CC, 320CC, 320EC, 330TE)
	20150338	Starboard Sea Foam Hatch (15 x 18 1/2) (290CC, 290DC, 290EC)

These parts should be installed by a certified World Cat dealer. Installation by a non-authorized 3rd party may result in improper enforcement and create safety concerns. Please contact your local, authorized, World Cat dealer to buy these parts at the same price.

Price and availability subject to change.

Service Class	Part Number	Description
	20151028	Storage Net (16" x 24")
	20151031	Storage Net (4" x 20.5")
	20151029	Storage Net (8" x 13")
	20160236	Thru Hull Plastic 90 1 1/2"
	20160236	Thru Hull Plastic 90 1 1/2"
	20160237	Thru Hull Plastic 90 3/4"
	20163462	Top Mount Hinge (4" x 4") (Class A)
	20150011	Transom End Cap, Nylon, Offwhite (World Cat)
	**20610386	Transom Molding (Arctic White) 12' EA Thinner / No Holes
	20160353	Trim-Lok X-108BT (Lids)
	20160352	Trim-Lok X-109BT (Lids)

These parts should be installed by a certified World Cat dealer. Installation by a non-authorized 3rd party may result in improper enforcement and create safety concerns. Please contact your local, authorized, World Cat dealer to buy these parts at the same price.

Price and availability subject to change.

Service Class	Part Number	Description
---------------	-------------	-------------



26500436 Vitrifrigo S/S Drawer DC Refrigerator



20163559 Windshield Latch S/S 90 (Taco)

Hardware- Hull



20690226 290/320/330 Bow Eye / 330 Stern Eye (5/8" x 4 5/8")



20160242 8" Cleat



20160351 Bow Eye 304SS 5/8" x 6" GLO, SS



20150225 Drain Plug (Garboard)



20160383 Transom Motor Plate (Lower)



20161423 Transom Motor Plate (Upper) - No Branding

Plumbing

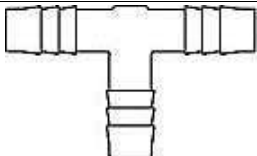

20160040 1 1/2 3 Way Tee Fitting

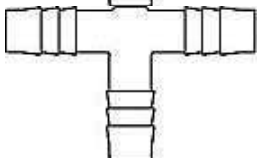









20160040 1 1/2 3 Way Tee Fitting

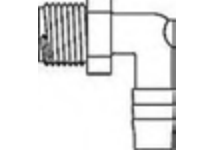
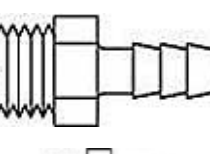
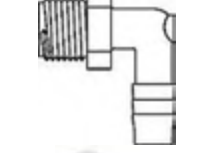

20160529 1 1/2" Threaded Tee

These parts should be installed by a certified World Cat dealer. Installation by a non-authorized 3rd party may result in improper enforcement and create safety concerns. Please contact your local, authorized, World Cat dealer to buy these parts at the same price.

Price and availability subject to change.

Service Class	Part Number	Description
	20160512	1 1/2" Waste Pump Out
	20160510	1 1/2" Water Fill
	20160087	1/2 PT X 3/4 HB "L", PVC Elbow 1234
	20160086	1/2 PT X 3/4 HB STR., PVC A1234
	20160093	1/2 PT X 3/8 HB "L", EL1238
	20220036	290DC Waste Tank 15 Gal
	20220035	290DC Water Tank 33 Gal
	20160466	3 Way Reducing Tee (1 1/8" x 3/4" x 1 1/8")
	20160092	3/4 PT X 3/4 HB, PVC, A34
	20160039	3/4 x 3/4 HB Tee
	20160039	3/4 x 3/4 HB Tee

These parts should be installed by a certified World Cat dealer. Installation by a non-authorized 3rd party may result in improper enforcement and create safety concerns. Please contact your local, authorized, World Cat dealer to buy these parts at the same price.

Price and availability subject to change.

Service Class	Part Number	Description
	20160127	3/4" Brass Intake w/ Nut Hi-Speed Water Pick up Bronze
	20160127	3/4" Brass Intake w/ Nut Hi-Speed Water Pick up Bronze
	20160560	Ball Valve, Brass, 3/4"
	20160560	Ball Valve, Brass, 3/4"
	26500258	Bar Faucet (Cabin Models)
	20160388	Barbed 1-1/8" 90 Degree Aerator Head - Livewell Inlet w/ Shutoff Black
	20160388	Barbed 1-1/8" 90 Degree Aerator Head - Livewell Inlet w/ Shutoff Black
	20140100	Bilge Hose 1 1/2" (100'/RL)
	20140099	Bilge Hose 1 1/8" (100'/RL)
	20140098	Bilge Hose 3/4" (100'/RL)
	20160037	Black Strainer Impact drain 1"-1/8"

These parts should be installed by a certified World Cat dealer. Installation by a non-authorized 3rd party may result in improper performance and create safety concerns. Please contact your local, authorized, World Cat dealer to buy these parts at the same price.

Price and availability subject to change.

Service Class	Part Number	Description
	W7010033	Bleeder Nipple-Teleflex Power Steering Pump
	W7010033	Bleeder Nipple-Teleflex Power Steering Pump
	20160556	Deck Fill Key
	20160339	Drain, Head 320EC
	20160349	Elbow 3/8" Compression Fitting to 1/4" Male Pipe Thread
	20160094	Elbow, Faucet 3/4 HB X 1/2 FPT
	20820440	Headhunter Inlet Strainer (3/4")
	W7013314	Impeller Kit for Shurflo Macerator Pump
	20160548	In-Line Water Filter Bracket
	20160548	In-Line Water Filter Bracket
	20150381	Jabsco Elongated Toilet Electric CE 12V

These parts should be installed by a certified World Cat dealer. Installation by a non-authorized 3rd party may result in improper performance and create safety concerns. Please contact your local, authorized, World Cat dealer to buy these parts at the same price.

Price and availability subject to change.

Service Class	Part Number	Description
	20530464	Livewell Hose 1 1/8" Black HD PVC (100'/RL)
	20160392	Livewell Overflow Drain (Threaded Internal 1 1/2" 90)
	20160392	Livewell Overflow Drain (Threaded Internal 1 1/2" 90)
	20740248	Macerator Pump w/ Deutsch Plug
	20160536	Nylon Elbow (3/4" MPT x 1" HB)
	20160267	Nylon Elbow 3/4" Male PT x 3/4" HB
	20161489	Nylon Female Adapter 1/2" FPTx 3/4" HB
	20161489	Nylon Female Adapter 1/2" FPTx 3/4" HB
	20160142	Plastic Elbow (3/4") 90 DEG
	20160221	Rubber Stopper (1 1/8") PP1118
	20740299	Rule-A-Matic Float Switch w/ Deutsch Plug

These parts should be installed by a certified World Cat dealer. Installation by a non-authorized 3rd party may result in improper enforcement and create safety concerns. Please contact your local, authorized, World Cat dealer to buy these parts at the same price.

Price and availability subject to change.

Service Class	Part Number	Description
	20740298	Rule-Non Automatic Bilge pump w/ Deutsch (1500 GPH)
	20140128	Sanitation Hose 1" (100'/RL)
	20140127	Sanitation Hose 1.5" (100'/RL)
	20740246	ShurFlo Livewell Pump w/ Deutsch (1100 GPH)
	20740246	ShurFlo Livewell Pump w/ Deutsch (1100 GPH)
	20740303	ShurFlo Pro Blaster 2 Water Pump
	20740303	ShurFlo Pro Blaster 2 Water Pump
	60233362	Sika White #292i-W High Strength Adhesive Sealer
	20160331	Stainless Sink Drain
	20160332	Stainless Sink Drain Reducer
	20820852	Strainer Mounting Bracket

These parts should be installed by a certified World Cat dealer. Installation by a non-authorized 3rd party may result in improper enforcement and create safety concerns. Please contact your local, authorized, World Cat dealer to buy these parts at the same price.

Price and availability subject to change.

Service Class	Part Number	Description
	20161462	Swivel Nut Water Strainer for Washdown Pumps
	20161462	Swivel Nut Water Strainer for Washdown Pumps
	20160355	Thru Hull Bronze 3/4"
	20160224	Thru Hull Plastic 1 1/2" w/ Scupper White
	20160218	Thru Hull Plastic 1 1/8"
	20160217	Thru Hull Plastic 3/4"
	20160219	Thru Hull Plastic 90 1 1/8"
	20163451	Thru-Hull, Resin 90° w/SS Cover, 1"
	20163452	Thru-Hull, Resin 90° w/SS Cover, 1-1/8"
	20163456	Thru-Hull, Resin w/SS Cover, 1-1/2"
	20163456	Thru-Hull, Resin w/SS Cover, 1-1/2"

These parts should be installed by a certified World Cat dealer. Installation by a non-authorized 3rd party may result in improper enforcement and create safety concerns. Please contact your local, authorized, World Cat dealer to buy these parts at the same price.

Price and availability subject to change.

Service Class	Part Number	Description
	20163455	Thru-Hull, Resin w/SS Cover, 1-1/8" - 1-1/4"
	20163454	Thru-Hull, Resin w/SS Cover, 3/4"
	20163457	Thru-Transom Scupper, Resin, w/ SS Cover, 1-1/2" (4-3/8")
	20160220	Vinyl Push Plug (1-1/2") Black
	20170878	Washer Jet (SS) - Bulkhead Mount
	20161447	Wingnut Adapter, 90 Nylon 3/4 HB X 1/2 NPT / for Washdown Pump
	20161447	Wingnut Adapter, 90 Nylon 3/4 HB X 1/2 NPT / for Washdown Pump
	20173467	Wiper Arm (19"-24")
	20170333	Wiper Blade (16")
	20170912	Wiper Controls Intermittent Switch

Service Kits



W7013422 Bushing, Stern Seat Black 7/8"ID X 1-1/16"OD

Steering

These parts should be installed by a certified World Cat dealer. Installation by a non-authorized 3rd party may result in improper performance and create safety concerns. Please contact your local, authorized, World Cat dealer to buy these parts at the same price.

Price and availability subject to change.

Service Class	Part Number	Description
	20180948	12' Hydraulic Hose
	20180948	12' Hydraulic Hose
	20180949	16' Hydraulic Hose w/ BH Fitting
	20180949	16' Hydraulic Hose w/ BH Fitting
	W7010050	50amp Fuse Assembly (for Power Steering)
	W7010050	50amp Fuse Assembly (for Power Steering)
	20180961	6' Hydraulic Hose w/ Bulkhead
	20180961	6' Hydraulic Hose w/ Bulkhead
	20180962	8' Hydraulic Hose
	20180962	8' Hydraulic Hose
	20180017	Bracket for Steering System Valve











These parts should be installed by a certified World Cat dealer. Installation by a non-authorized 3rd party may result in improper enforcement and create safety concerns. Please contact your local, authorized, World Cat dealer to buy these parts at the same price.

Price and availability subject to change.

Service Class	Part Number	Description
	20180017	Bracket for Steering System Valve
	20180966	Gem 15" 3-Spoke S/S Steering Wheel w/ Ball Bearing Knob (w/ 1501-- 5/8" wheel nut)
	20180941	Gem Steering Wheel Nut (M12 for Uflex/Yamaha Helm Master)
	20180022	Hydraulic Tilt Helm Sea Star HH6541
	20180022	Hydraulic Tilt Helm Sea Star HH6541
	20180046	Kevlar 6' Hydraulic Hose w/ Bulkhead
	20180123	Kevlar 8' Hydraulic Hose
	90180097	Sea Star Cylinder HC5375-3 (Hon/Suz/Yam) (2014 Cylinder)
	90180097	Sea Star Cylinder HC5375-3 (Hon/Suz/Yam) (2014 Cylinder)
	20180062	Seastar Power Assist Unit
	20180062	Seastar Power Assist Unit











These parts should be installed by a certified World Cat dealer. Installation by a non-authorized 3rd party may result in improper enforcement and create safety concerns. Please contact your local, authorized, World Cat dealer to buy these parts at the same price.

Price and availability subject to change.

Service Class	Part Number	Description
	20180018	Steering Whitey Ball Valve
	20180018	Steering Whitey Ball Valve
	90410401	Suzuki LH Prop (3 x 16 x 18.5)
	90410400	Suzuki RH Prop (3 x 16 x 18.5)
	20180034	Teleflex Hydraulic Tee
	20180034	Teleflex Hydraulic Tee
	20180031	Teleflex Hydraulic Tee (3/PK)
	20180031	Teleflex Hydraulic Tee (3/PK)
	20180094	Teleflex Power Steering Diode (Keyswitch)
	90410451	Yamaha LH Prop (3 x 15.25 x 19) SWS II SDS
	90410446	Yamaha LH Prop (3 x 15.5 x 17) SWS II SDS







These parts should be installed by a certified World Cat dealer. Installation by a non-authorized 3rd party may result in improper enforcement and create safety concerns. Please contact your local, authorized, World Cat dealer to buy these parts at the same price.

Price and availability subject to change.

Service Class	Part Number	Description
	90410450	Yamaha RH Prop (3 x 15.25 x 19) SWS II SDS
	90410445	Yamaha RH Prop (3 x 15.5 x 17) SWS II SDS
Upholstery		
	20290941	295DC Cushion Stern Seat Backrest (Port/Stbd) (NEW PART) 3/22/2013
	20290942	295DC Cushion Stern Seat Base (Port/Stbd)(NEW PART) 3/22/2013
	20290943	295DC Forward Bow Back (NEW PART) 3/22/2013
	20290944	295DC Forward Bow Cushion (NEW PART) 3/22/2013
	20290955	295DC Helm Seat Assy (Stbd) w/ Bolsters/Backrest (295DC)
	20290945	295DC Port Aft Bow Cushion (NEW PART) 3/22/2013
	20290946	295DC Port Bow Back (NEW PART) 3/22/2013
	20290947	295DC Port Cockpit Bolster (NEW PART) 3/22/2013
	20290956	295DC Port Forward Bow Cushion (NEW PART) 3/22/2013

These parts should be installed by a certified World Cat dealer. Installation by a non-authorized 3rd party may result in improper enforcement and create safety concerns. Please contact your local, authorized, World Cat dealer to buy these parts at the same price.

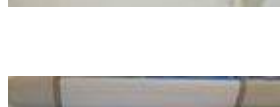
Price and availability subject to change.

Service Class	Part Number	Description
	20290948	295DC Port Helm Box Cushion (NEW PART) 3/22/2013
	20290949	295DC Port Helm Seat w/ Backrest
	20290951	295DC Starboard Aft Bow Cushion (NEW PART) 3/22/2013
	20290952	295DC Starboard Bow Back (NEW PART) 3/22/2013
	20290953	295DC Stbd Cockpit Bolster (NEW PART) 3/22/2013
	20290954	295DC Stbd Forward Bow Cushion (NEW PART) 3/22/2013
	20291014	295DC Stbd Helm Box Cushion (Morbern) (NEW PART) 5/15/2013

These parts should be installed by a certified World Cat dealer. Installation by a non-authorized 3rd party may result in improper enforcement and create safety concerns. Please contact your local, authorized, World Cat dealer to buy these parts at the same price.

Price and availability subject to change.