

2001
OWNER'S MANUAL



HULL # EPY _____

WCC Group, Inc. / World Class Catamarans Limited Warranty – 2001 Models

WARRANTY TRANSFER PROCEDURE

For a transfer fee, WCC Group, Inc. will extend warranty coverage to subsequent owners of 2001 models within the first five years of the warranty period. Notification of a change of ownership, including: hull identification number, names, addresses and telephone numbers of both the former and new owners, a dated and notarized bill of sale, the appropriate fee (see schedule below) must be sent to WCC Group, Inc., Warranty Registration, 801 Staton Rd., Greenville, NC 27834 within ten (10) days of purchase by the new owner who will be notified in writing that the transfer has been approved within ten (10) days by WCC Group. The subsequent owner and WCC dealer should complete a warranty card along with a signed warranty sheet.

Within the 1 st year	\$ 500.00
Within the 2 nd year	\$ 400.00
Within the 3 rd year	\$ 300.00
Within the 4 th year	\$ 200.00
Within the 5 th year	\$ 100.00
After the 5 th year	-not transferable

WCC Group, Inc. reserves the right to modify its products through changes in design and/or material without notice and without obligation to incorporate changes on models of prior manufacture, at any time throughout the year. We may be contacted at WCC Group, Inc., 801 Staton Road, Greenville, NC 27834.

THERE ARE NO WARRANTIES THAT EXTEND BEYOND THE DESCRIPTION ON THE FACE HEREOF.

WARRANTY REGISTRATION

Hull Identification No. EPY _____
State Registration No. _____ State _____
Date of Bill of Sale _____ Delivery Delivery _____
Purchaser _____ Date of Birth _____
Address _____
City _____ State _____ Zip _____
E-mail Address _____ Home Phone _____
Cell Phone (____) _____ Work Phone (____) _____
Selling Dealer _____
Engine Information: Mfg: _____ HP: _____ Model: _____
Serial # (Port) _____ Serial # (Stbd) _____
Received at WCC _____

WORLD CAT™
OWNERS MANUAL – 2001 MODELS
TABLE OF CONTENTS

TOTAL OWNER PRODUCT SATISFACTION	ii
LIMITED WARRANTY STATEMENT	1
WARRANTY TRANSFER PROCEDURE	2
COMPONENTS SUPPLIER LISTING	3
ADVISORY LABELS	4 - 5
CARE & GENERAL INFORMATION	6 - 8
RIGGING GUIDELINES	9
STEERING SYSTEM	10 - 11
FUEL SYSTEM	12 - 14
FRESH WATER SYSTEMS	15 - 17
RAW WATER SYSTEMS	18 - 20
LIVEWELL OPERATION & PIPING SYSTEM	21
ELECTRICAL SYSTEM	22
BATTERY INFORMATION	23
WIRING CODE	24
GAUGE TROUBLESHOOTING QUICK REFERENCE	25
INSTRUMENT OPERATION & TROUBLESHOOTING	26 - 29
WINDLASS WIRING, OPERATION & MAINTENANCE	30 - 31
TRAILER BRAKE REQUIREMENTS	32

APPENDICES:

- A. PANEL, SWITCH & INSTRUMENT WIRING DIAGRAMS
- B. HELPFUL INFORMATION
- C. OPTIONAL FLO-SCAN INSTRUMENTATION DATA

FOR FURTHER INFORMATION, CONTACT YOUR WORLD CAT™ DEALER, OR:

WCC GROUP, INC. ATTN: CUSTOMER SERVICE
801 STATON RD., GREENVILLE, NC 27834
Tel: (252) 754-1948 Fax: (252) 754-1949

e-mail fmunden@worldclasscatamarans.com

“TOPS”

World Class Catamaran's Program for Total Owner Product Satisfaction

Total Owner Product Satisfaction is a critical part of World Class Catamaran's business mission, and every member of the World Class Team is dedicated to making your ownership of our products a satisfying and rewarding experience. From the individuals in our production departments that hand-craft every aspect of your boat, through to our local Dealer's personnel, each is dedicated to this mission and the TOPS program has been developed to assure your complete satisfaction.

It is important to all of us that any problems that may arise are dealt with in a timely and professional manner. All warranty and service matters regarding your World Class Catamaran boat are handled through our authorized dealers. If for any reason you are not satisfied with any aspect of your Dealer's performance, please contact the owner of the dealership where you made your purchase, fully explain the problem, and ask for assistance in resolving the situation. The owner is usually in the best position to help you, and is concerned with both your overall satisfaction and your future business.

If you do not receive satisfaction after working with your dealer, and if you believe that you require further assistance, please WRITE to us at the address below. Please be certain to include the model, identification number, date of purchase, type of power, hours of use and installed accessories. Also provide a dated sequence of events, including actions taken by both you and the dealer. Please include copies of related receipts, photographs, and any other pertinent information including names and positions of dealership personnel with whom you have been working.

Upon receipt of your WRITTEN correspondence, we will contact both you and the dealership to review, and then resolve the situation.

In order to provide a permanent record for all parties, all service and warranty resolutions will take place ONLY through WRITTEN correspondence.

Our mailing address: WCC Group, Inc.
Customer Service
801 Staton Road
Greenville, NC 27834

Or Fax to (252) 754-1949

Or you may e-mail your comments to jhill@worldclasscatamarans.com or visit our website at www.worldclasscatamarans.com

WCC Group, Inc. / World Class Catamarans Limited Warranty – 2001 Models

WARRANTY COVERAGE

WCC Group, Inc. (hereinafter referred to as the Manufacturer) warrants to the original purchaser, or subsequent owners unless excepted, that the hull shall be free from structural defects in materials and/or workmanship for a period of five (5) years from the date of original purchase. It is further warranted to the original purchaser that the hull shall remain free from defects in materials and workmanship for an additional five (5) years from the date of original purchase for a total of ten (10) years, the hull being defined as the single fiberglass casting which rests on the water. Products that are proven to be defective within the applicable warranty period, when used and maintained according to the Manufacturer's instructions, will be repaired or replaced by the Manufacturer, or one of its dealers, at the option of the Manufacturer, and only after prior authorization by the Manufacturer. All warranty claims in excess of \$200.00 will require substantiation prior to authorization, at the option of the Manufacturer. During the first five- (5) years after the original purchase, following the procedure explained in the Owner's Manual may transfer this warranty.

WARRANTY VOIDING

This warranty is voided in its entirety if the boat is powered with outboard engines of a higher horsepower rating than is recommended by the Manufacturer as evidenced on the Coast Guard Certification Plate attached to the boat, and/or hull modification in any way.

LIMITATIONS

Warranty coverage for Parts & Accessories does not extend to any Purchaser other than the original purchaser from the Manufacturer's authorized dealer. Warranty coverage does not include:

1. Outboard motors, propellers, batteries, mechanical steering, chrome, windshield breakage and/or leakage, instruments, gauges, electronics, pumps, anti-fouling paint or any component or accessory not manufactured by the Manufacturer and expressly warranted by the manufacturer thereof. Refer to the Owner's Manual for specific warranty details on components and accessories, and vendors who cover their own warranty.
2. Cosmetic issues such as: Gel-coat cracking, crazing, fading or discoloration and graphics.
3. Fiberglass blistering attributable to water penetration of the fiberglass (osmosis) is specifically EXCLUDED from warranty.
4. Damage caused by misuse, abuse, customer negligence, collision, racing, accidents, grounding, improper wiring, theft, normal deterioration, Acts of God, damage and deterioration resulting from environmental conditions, improper cleaning, maintenance, handling, trailering, lifting, or storage as determined by WCC.
5. UV deterioration, vinyl material after 30 days and/or improper cleaning of upholstery causing direct damage.
6. Any repairs, adjustments or modifications to a boat and/or any of its components made by anyone other than an authorized dealer, or a pre-approved facility by the manufacturer. Damage or deterioration of the boat and/or its components due to the attachment of hardware, equipment, electronics, other components and/or the installation of said items that are not previously approved and authorized by the manufacturer.
7. Damage which has occurred as a result of the boat being operated as a demonstrator, displayed for sale and/or if the boat is a part of a rental fleet.
8. Fuel contamination of any kind is specifically EXCLUDED from this warranty.
9. Boats used for commercial activity, including charter and/or tournament, or for profit are EXCLUDED from coverage in this warranty.

Repair or replacement, at the option of the Manufacturer, is the exclusive remedy under this warranty. In no event shall the Manufacturer be liable for any consequential or incidental damages, including, but not limited to, personal loss of time, inconvenience, telephone, food, lodging, loss to personal property, loss of revenue and profits, loss of use, storage bills, charges for transportation, service calls and/or charges for hauling (in or out of the water), in order to effect warranty repair, unless provided for under local statute, in which case these exclusions may not be applicable. TO THE EXTENT ALLOWED BY LAW, ANY AND ALL IMPLIED WARRANTIES, INCLUDING THE IMPLIED WARRANTY OF MERCHANTABILITY AND ANY APPLICABLE IMPLIED WARRANTY OF FITNESS FOR A PARTICULAR PURPOSE ARE LIMITED TO THE DURATION OF THIS WARRANTY, UNLESS PRESCRIBED BY LOCAL STATUTE. The rights and obligations of the Purchaser and the Manufacturer under this written warranty may not be varied or modified.

RESPONSIBILITY OF THE PURCHASER

1. This warranty extends ONLY TO THE ORIGINAL PURCHASER OR SUBSEQUENT PURCHASER ON THE CONDITION the owner, or subsequent owner, completes and mails the warranty card and other signed pertinent documents to WCC Group, Inc., 801 Station Rd., Greenville, NC 27834 within ten (10) days after taking delivery of the boat.
2. The original purchaser or approved transferee must give WRITTEN NOTICE of the claimed defect to an authorized dealer within ten (10) days after first detecting the claimed defect. It must appear to the Manufacturer's reasonable satisfaction that the claimed defect is covered by warranty. Purchaser must give WRITTEN NOTICE to WCC Group, Inc., Warranty Claims, of any failure by an authorized dealer to respond to a claimed defect within ten (10) days after first notification to the authorized dealer.
3. The boat, including any claimed defective part, MUST be returned to an authorized dealer, or elsewhere, as directed by the Manufacturer, or to the Manufacturer within the warranty period for inspection and warranty service. Service calls are the sole responsibility of the purchaser. ALL EXPENSES incurred returning the boat to the authorized dealer and returning the boat to the owner are to be paid by the owner. It is highly recommended that you have a trailer for transporting your boat if permissible over state highways.

THIS WARRANTY WILL BE DEEMED NULL AND VOID IF THIS SIGNED FORM ALONG WITH THE ATTACHED WARRANTY CARD CONTAINING THE NECESSARY INFORMATION REQUIRED ARE NOT RETURNED WITHIN TEN (10) DAYS OF THE PURCHASE TO FACILITATE THE HANDLING OF ANY CLAIM THAT MAY ARISE UNDER THE TERMS OF THIS LIMITED WARRANTY AND TO COMPLY WITH THE FEDERAL BOATING SAFETY ACT OF 1971.

Owner's Signature (Required)

Dealer's Signature (Required)

WORLD CAT™ Component Suppliers

<u>SUPPLIER</u>	<u>PRODUCT(S)</u>	<u>WARRANTY</u>	<u>TELEPHONE#</u>
Atlantic Marine Products	Electrical Panels	1 yr.	(757) 466-8756
Bomar	Cabin & Console Portlights	1 yr.	(603) 826-5791
Clarion Marine Audio	Stereo System	1 yr.	(800) 754-9876
Custom Marine Fabrication	Cabin & Console Tops	3 yrs.	(252) 638-2920
Diesel Equip. Co.	Windshield Wiper Assembly	2 yrs.	(800) 222-7159
Dura-Cast	Fresh Water tank	1 yr.	(800) 683-4116
Faria Gauges	Gauges	1 yr.	(800) 473-2742
FloJet	Washdown/Freshwater Pumps	1 yr.	(800) 235-6538
FloScan	TwinScan	1 yr.	(206) 524-6625
Galley Maid	Marine Head	1yr.	(561) 848-8696
Lewmar Marine	Cabin Hatch	3 yrs.	(203) 458-6200
Perko	Bow / Stern Lights	5 yrs.	(305) 621-7525
Rule Industries	Bilge Pumps	5 yrs. pro-rated	(978) 281-0573
Rule Industries (div.)	Danforth Compass	3 yrs.	(978) 281-0573
Scandvik	Washdown Faucet & Shower	1 yr.	(800) 535-6009
ShurFlo	Livewell Pumps	1 yr.	(800) 854-3218
Simpson Lawrence	Windlass	1 yr.	(800) 946-3527
SS Marine	T-top (226SF only)	3 yr.	(757) 588-1950
SS Marine	Aluminum Helm Seating	1 yr.	(757) 588-1950
Tampco	Bow Rail	1 yr.	(336) 835-8091
Teleflex	Hydraulic Steering	2 yrs.	(904) 389-4536
Thetford	Porta-Potti	1 yr.	(800) 354-4135
Water Bonnet	246DC & Cabin Windshield	1 yr.	Contact WCC
Windline	Transom Ladder	1 yr.	(310) 516-9812

Note: Contact the listed vendor for component replacement and warranty. Most parts will have the manufacturer's name located on the part. Please attempt to be certain that the vendor that you contact is the supplier of the part required, or see your dealer.

World Class Catamarans
ADVISORY LABELS – 2001 World Cat

WARNING

AVOID SERIOUS OR FATAL INJURY.
DO NOT OCCUPY FORWARD SEATS
WHILE UNDERWAY.

Model 266SC Only
Bow Area Seating

CAUTION

TORQUE ENGINE MOUNTING BOLTS TO
40 FT. LBS. (4.56Kgm) ONLY.
RETORQUE PERIODICALLY,
BUT AT LEAST ANNUALLY.

ALL MODELS
Transom Area
(2 Installed)

DANGER

STOP ENGINES BEFORE USE
OF BOARDING LADDER.

ALL MODELS
Center Transom Area

WARNING

DO NOT LEAVE BATTERY SWITCH
IN "ON" POSITION WHEN BOTH
ENGINES ARE RUNNING

ALL MODELS
Starboard Battery
Compartment

WARNING

LEAKING FUEL IS A FIRE & EXPLOSION HAZARD.
INSPECT FUEL SYSTEM REGULARLY FOR LEAKS
& CORROSION, BUT AT LEAST ANNUALLY.

ALL MODELS
Battery Compartments,
Fuel Vents, Fill Hoses,
Access Ports

World Class Catamarans

ADVISORY LABELS – World Cat 246DC

Your Model 246DC World Cat boat is equipped with a three-piece safety glass windshield. The center portion is a hatch (door) that allows access to the bow area of the boat. This hatch must be kept in the closed position at all times when the boat is being operated. There is extreme danger to the passengers should the door be left open during operation as the wind flow could cause it to suddenly close and severely hurt anyone standing between the two consoles.

Please caution all passengers as to this danger. The following warning label is installed on the door to remind you of this potential hazard.



CARE, CLEANING & GENERAL INFORMATION

Some simple maintenance tasks performed on a regular basis will keep your WORLD CAT in top condition. Even if you are a seasoned skipper, we suggest that you spend a few minutes reviewing the following information. If you have further questions, talk with your dealer for specific recommendations.

GENERAL CARE

The gelcoat surface of your boat is the best available, and is formulated to resist UV degradation for many years. However, accumulated dirt and mineral deposits will cause the finish to lose that "showroom" look more rapidly. Regular washdowns with fresh water and the use of a mild detergent, such as Ivory liquid, will extend that new boat look. In addition, an occasional coat of marine paste wax will further protect all surfaces. Use of harsh chemical or abrasive cleaners is NOT recommended.

STAINLESS STEEL

Contrary to popular belief, stainless steel is not "stainless." Without proper care, it can rust and discolor gelcoat surfaces (bleeding). Regular washdowns with fresh water and detergent will lessen that possibility. Occasional waxing or wiping down with a product such as Corrosion-Bloc will protect the stainless steel components. NEVER USE STEEL WOOL on rusted areas. It will scratch the protective surface, causing irreparable damage. Avoid the use of any product not specifically designed for use on stainless steel, and check to make certain that other nearby surfaces will not be damaged through such use. For further information, refer to the care pamphlet included with this Manual.

SUNBRELLA

Sunbrella should be cleaned regularly before dirt and mineral deposits become embedded in the fabric. Lightly soiled Sunbrella can be cleaned without removal from the installation. Brush off loose dirt, etc., wet down with fresh water and clean with a mild solution of Ivory liquid and lukewarm water.

For heavily soiled fabric, removal from the frame is necessary. Soak in a solution Ivory liquid and lukewarm water. Allow the fabric to soak brush out stains with a soft bristle kitchen scrub brush. Rinse the fabric repeatedly in cold water to remove soap residue. Allow the fabric to AIR DRY completely before re-installing.

NEVER store any Sunbrella while wet or dirty, or in a moist unventilated area. ALWAYS roll the fabric instead of folding, particularly on side curtains with clear plastic windows. To prevent cracking, curtains with plastic windows should be stored inside when not in use and not stored in cold temperatures. Roll Bimini tops carefully around the collapsed bows and cover with the storage boot.

ZIPPERS & SNAPS

Occasional light lubrication with Corrosion-Bloc will keep these parts operating smoothly. Avoid spraying lubricant on adjacent fabric or acrylic surfaces.

CLEAR ACRYLIC, VINYL WINDOWS & PORTS

Clean with a mild solution of Ivory liquid soap and lukewarm water, using a soft cloth. Use of Pledge furniture polish (NOT lemon-scented) will extend the life of flexible clear vinyl and prevent shrinkage. If scratched, use a product made for clear acrylic scratch removal. Use of automotive products such as Armorall may permanently cloud the surface. Always roll the canvas and clear acrylic, vinyl windows when storing. DO NOT FOLD AND CREASE.

INTERIOR CUSHIONS (Cabin Model Only)

Brush and/or vacuum to remove loose dirt. In case of spill and/or stain, remove excess with a damp cloth. Clean with a 1:1 mix of Whisk liquid house cleaner and lukewarm water, applying the foam only with a soft brush. Do NOT saturate. Rinse with clean water and dry. Use straight applications of concentrated cleaners such as 409 or Fantastic spray cleaner, if needed. If absolutely necessary, use a 1:1 mix of ammonia and water to remove the most stubborn stains. Pre-test a small, inconspicuous area before proceeding. Always allow thorough AIR DRYING before placing cushions back in the cabin.

VINYL CUSHIONS

Regular washing with a solution of water and Ivory liquid as part of general boat care is recommended. Exterior cushions are closed-cell foam. Use a protective product specifically formulated for marine vinyl to provide UV protection. Use of automotive products such as Armorall may deteriorate surfaces and shorten fabric life. Warranty is for UV protection and thread deterioration only.

FRESH WATER TANK

Cleaning or deodorizing the fresh water tank may be accomplished by filling the tank with a 5% solution of household bleach and water after draining the contents of the tank. Add approximately 10 gal. Water, then add 1 gal. Bleach – fill the remainder of the tank with water. Let stand for several hours. Drain the tank, refill and drain repeatedly until all chlorine odors are removed.

WINTERIZATION/LAY-UP

Refer to the motor manufacturer's manual for storage instructions. Drain all fresh and raw water tanks. Remove batteries and store in a dry cool area (not on a cement surface); maintain charge levels with a trickle-charger. Drain fuel tanks, or fill completely as per local practice or regulation. If full tanks are stored for more than 30 days, it is recommended that a fuel stabilizer be added to prevent degradation. Remove all personal items and portable electronics. Wash the boat thoroughly with a solution of fresh water and Ivory liquid and apply a coat of marine paste wax. If covering, provide some means of ventilation to prevent moisture and/or heat damage. All pumps should be drained and prepped for winterization to keep pumps from freezing and cracking.

BOTTOM PAINTING

If your WORLD CAT is to be left in the water for extended periods, it is strongly recommended that an application of high-quality bottom paint be applied to protect against marine growth and deteriorated performance. It is strongly recommended that you apply an epoxy barrier coat before applying bottom paint to your New World Cat for the first time to help ensure longer protection. Bottom painting is NOT an absolute protection against gelcoat blistering and it is NOT warranted. Follow all manufacturer precautions regarding the use of personal protective equipment, etc. Hint: To establish the waterline for masking, put the boat in the water for a few days to establish a "scum line" and mask off accordingly.

LIFTING/DRY-STACK STORAGE

The WORLD CAT may be lifted and stored through the use of the (optional) bow lifting eye and the dual transom eyes. Use a spreader bar at the stern to prevent damage to the outboard motors. Slings may also be used for lifting only, taking care to support the stern just aft of the fish box and forward, at least at the front of the console or the cabin windshield. A "cat's cradle" from FLOAT-ON is recommended for long-term dry storage. (Do NOT store your boat on slings for prolonged periods of time. Lifting the boat with a forklift may be accomplished through the use of slings, with a supportive lifting platform (see your dealer) or through the center of the tunnel, if the forks can be collapsed sufficiently. Because of the rounded bottom of the hulls and the narrow chines, it is specifically recommended that your dry stack operator NOT attempt to lift the World Cat from the outside of each hull.

TRANSDUCERS

Transducer mounting is more difficult on a Power Cat due to the narrow hulls requiring a transom mounting point near the outboards; a possible cavitation problem may result. With the advent of higher power transducers, it is possible to mount them inside the bilge at the bottom, just forward of the bilge pumps (not in silicone - refer to the manufacturer's instructions). For tri-ducer installations (depth, temp, speed), it may be best to purchase a separate speed and temp sensor to mount on the outside of the transom.

WCC is now offering a factory-installed 50/200 KHZ 600-watt bronze, low profile, 8-pin transducer installed in the starboard sponson near the transom. If this option is ordered after the boat has been built, it will be necessary to fiberglass a small block for mounting the transducer. This unit is for depth only and extends 5mm (0.19) below the hull of the boat. Before you purchase your electronics, you need to make sure that your electronics will accept our transducer based on KHz and adapter pins. Some electronics are proprietary and their cables and pins will not work. The transducer supplied is AIRMAR's Model B117 and it will work with many quality depth finders and fishfinders. Some manufacturer's models will plug directly into the 8-pin connector, but others will require an adapter that is available through GEM ELECTRONICS Co. They can be reached at (843) 394-3565. When ordering, please provide them with the exact model number and brand name of your depth finder or fishfinder. Also, they can provide extra lengths of cable for the adapter if needed.

GEM ELECTRONICS CO. can also assist you with the selection of a high quality speed / temperature sensor that is suitable for installation on the transom of your World Cat.

For additional information, please contact Ken Comfort at WCC's Technical Support Group.

WORLD CAT™

RIGGING INFORMATION

Note: These are general recommendations for the proper rigging of a World Cat. In all cases, however, the experience of the installation technician regarding safe procedures should prevail.

Motor Mounting Transom height is 25", requiring the use of x-long 25" shaft motors. The installation height will be slightly higher than on a conventional monohull to allow cavitation to occur within reasonable limits to provide the best acceleration. Generally, the cavitation plate height is the best reference to determine which bolt hole to use – the plate should be level with the bottom, or no higher than ¼" above the bottom. Higher installations may cause bow steering conditions, may require the use of low water pickups to prevent overheating and may also result in premature blow-out of the props; therefore, extreme mounting heights are not recommended. Motor mounting bolts should be torqued to 40 ft. lbs. (4.56 Kgm) ONLY. Re-torque mounting bolts periodically, but at least annually.

Motor Toe It is recommended that the relationship between the two motors' direction of thrust (toe) be set at zero to achieve the lightest steering effort and best performance. To adjust toe, refer to the steering section below.

Steering Adjustment The dual cylinder hydraulic steering system features a "liquid tie-bar" to allow both motors to respond to the helm in unison. (Refer to the diagrams in this manual.) Occasionally, it will be necessary to realign the motors due to normal use. To align the motors, first center the starboard motor by turning the helm. Then, open the system ball valve (located beneath the inspection port on the dive platform) by turning it 90 degrees. This will isolate the port motor from the system and allow it to be moved manually. Center the port motor by hand, then close the ball valve and replace the inspection cover port. Note: It may become necessary to purge ("bleed") the hydraulic system of air from time to time. Refer to the Teleflex steering system bleeding instructions on the next page.

Trim Tabs Setting the trim tabs properly will provide uniform steering effort as the helm is turned to port and starboard. The tabs serve to neutralize the torque effect of the motors on the steering system. For conventional rotation motors, the tab will be set with trailing edge approximately 3/16" to the right. (The adjustment is the same for both motors, if both are standard rotation.) If a counter-rotation motor is installed on the port side, that tab will be set with the trailing edge approximately 3/16" to the left.

Tilt Angle Install the tilt pin or limiting bolts slightly out to achieve a neutral (straight up & down) position of the motors relative to the hulls. This will reduce any bow steering tendency in the mid-speed range. For Yamaha installations (no tilt pins), it is recommended to trim the motors no further in than 1 bar on the tilt gauges.

Propeller Selection There are a wide variety of OEM and after-market propellers that will provide excellent performance. Your dealer can give customized recommendations based upon your specific requirements. Generally, 3-blade stainless steel props offer better overall performance than aluminum. Propellers with full blade area and cupping (i.e. Mercury Mirage Plus) perform well on power catamarans. Due to different variables, we suggest that you discuss this with your dealer and/or the engine manufacturer.

Steering System - Layout and Components (All Models)

Note: Teleflex requires that all steering system fittings be sealed with Hydraulic Thread Sealant.

AVOID PLACING SEALANT ON THE FIRST (LEADING) THREAD, AS THE SYSTEM CAN BECOME CONTAMINATED LEADING TO STEERING FAILURE. READ INSTRUCTIONS ON TUBE PRIOR TO USE.

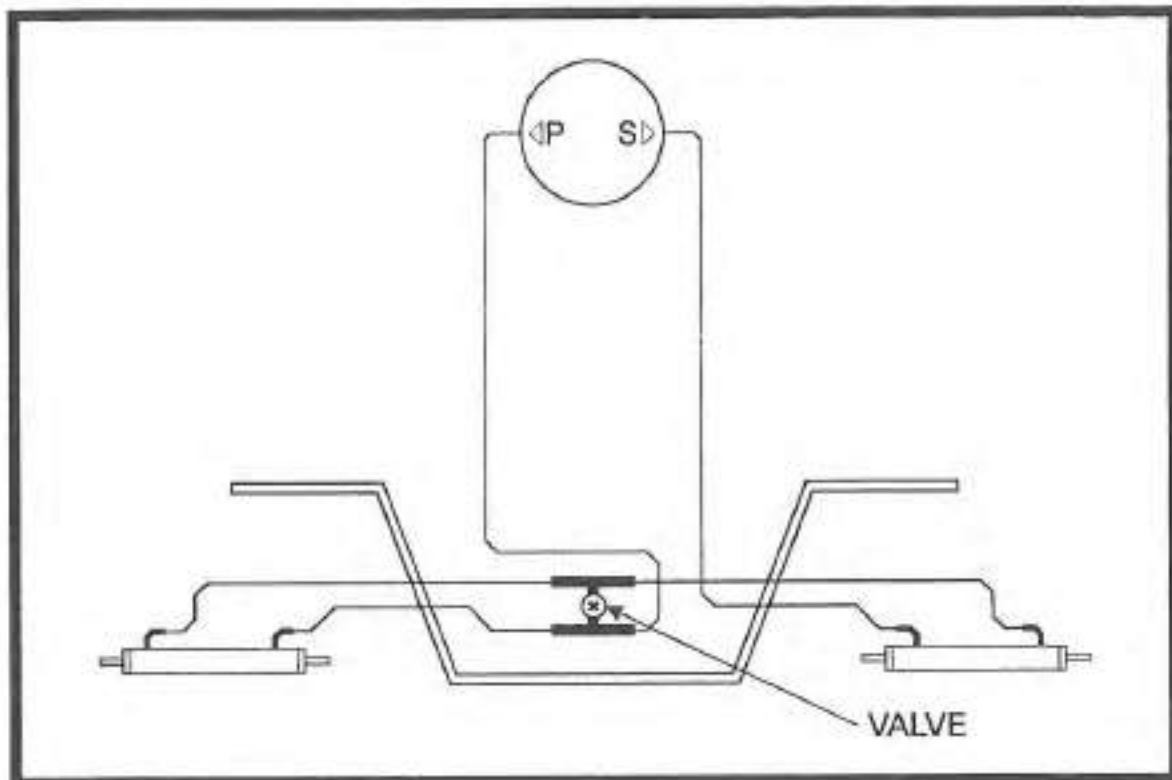

<u>Quantity</u>	<u>Description</u>	<u>Part #</u>	<u>Application</u>
1	Helm Pump	1.7 Tilt Helm	All Models
2	O/B Cylinders	HC 5345	All Models
1	20' Hose	HO5120	266SC
1	18' Hose	HO5118	246DC / 226SF / 246SF / 266SF
3	4' Hoses (pigtail)	HO8304	All Models
1	Whitey Valve	B-43F4	All Models
2	Tube End Filter	600603	All Models
1	Bulkhead Fittings		All Models
1	Valve Bracket		All Models

Catamaran Bleeding Instructions

Refer to the original system owner's manuals purging instructions and read entire text.

Proceed as follows:

Referencing the cylinder alignment valve installation schematic.

- Fill helm with oil and attach filter device/container to helm (do not overfill)
- Open valve
- Open bleed fitting #1 and pull cylinder shaft all the way on fitting #1 side of cylinder
- Turn steering wheel clockwise until an air-free stream of oil comes forth from bleed fitting#1

DO NOT ALLOW SHAFT TO MOVE BACK INTO CYLINDER. HOLD WITH HAND TO STOP IT FROM MOVING.

- Close bleed fitting #1
- Open bleed fitting #2 and pull cylinder shaft all the way out on fitting #2 side of cylinder
- Turn wheel counter-clockwise until an air-free stream of oil comes forth from bleed fitting #2, then close bleed fitting #2
- Open bleed fitting #3 and pull cylinder shaft all the way out on fitting #3 side of cylinder
- Turn wheel counter-clockwise until an air-free stream of oil comes forth from bleed fitting #3, then close bleed fitting #3
- Open bleed fitting #4 and pull cylinder shaft all the way out on fitting #4 side of cylinder
- Turn wheel clockwise until an air-free stream of oil comes forth from bleed fitting #4, then close bleed fitting #4
- Turn steering wheel back and forth from hardover to hardover a couple of times. Align cylinders by pulling cylinder rod all the way out on the same side of each cylinder and close valve.

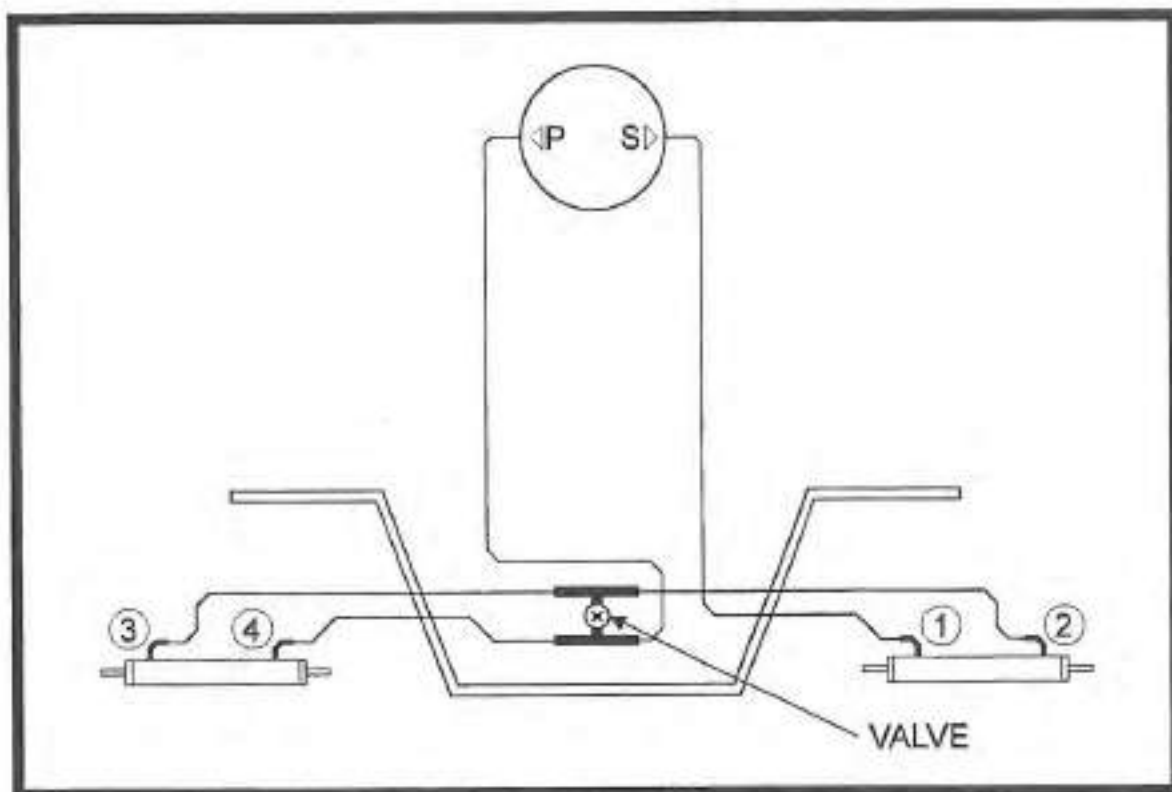

Fuel System

246DC

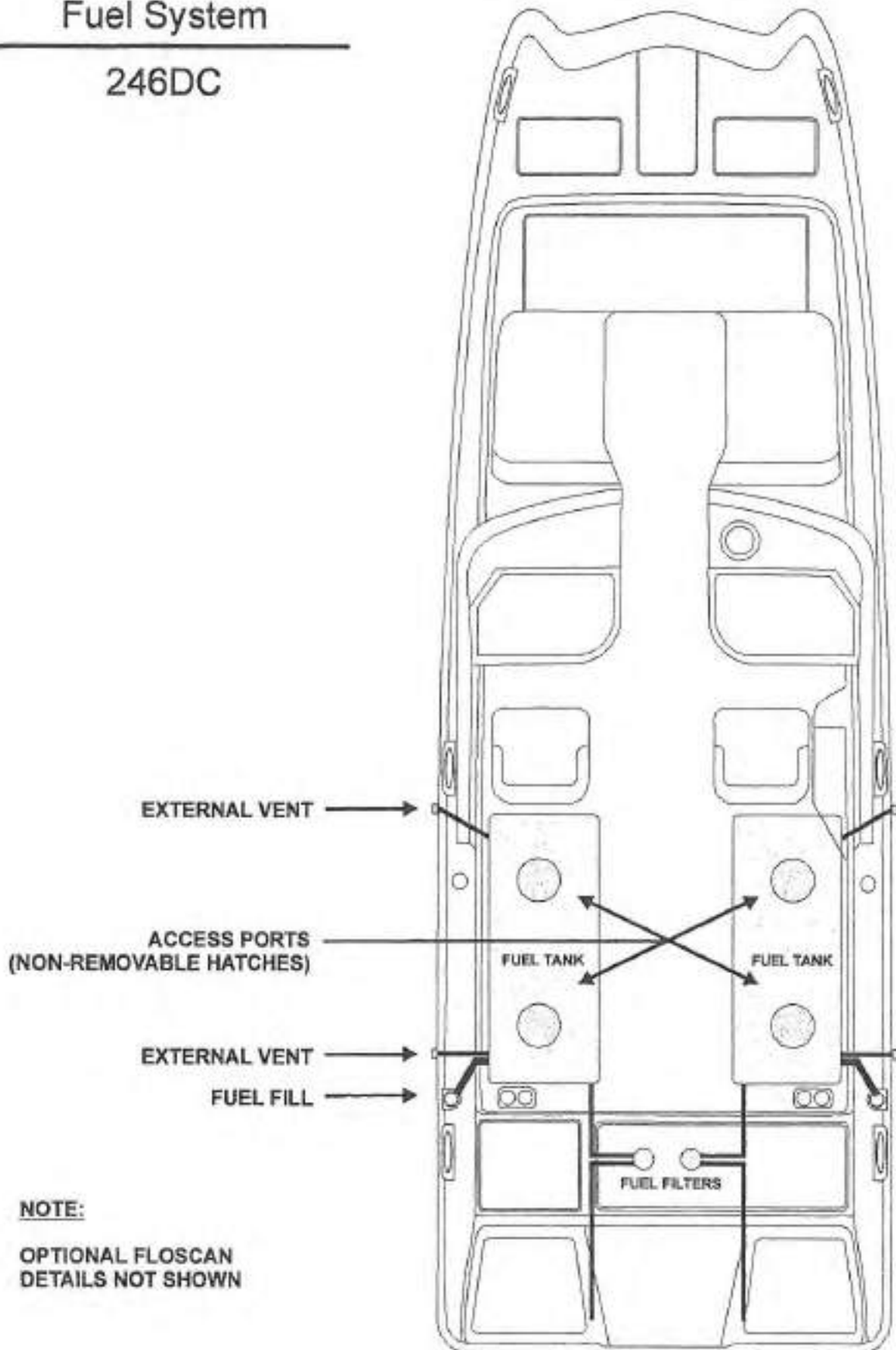

NOTE:

OPTIONAL FLOSCAN
DETAILS NOT SHOWN

Fuel System

226SF / 246SF / 266SF

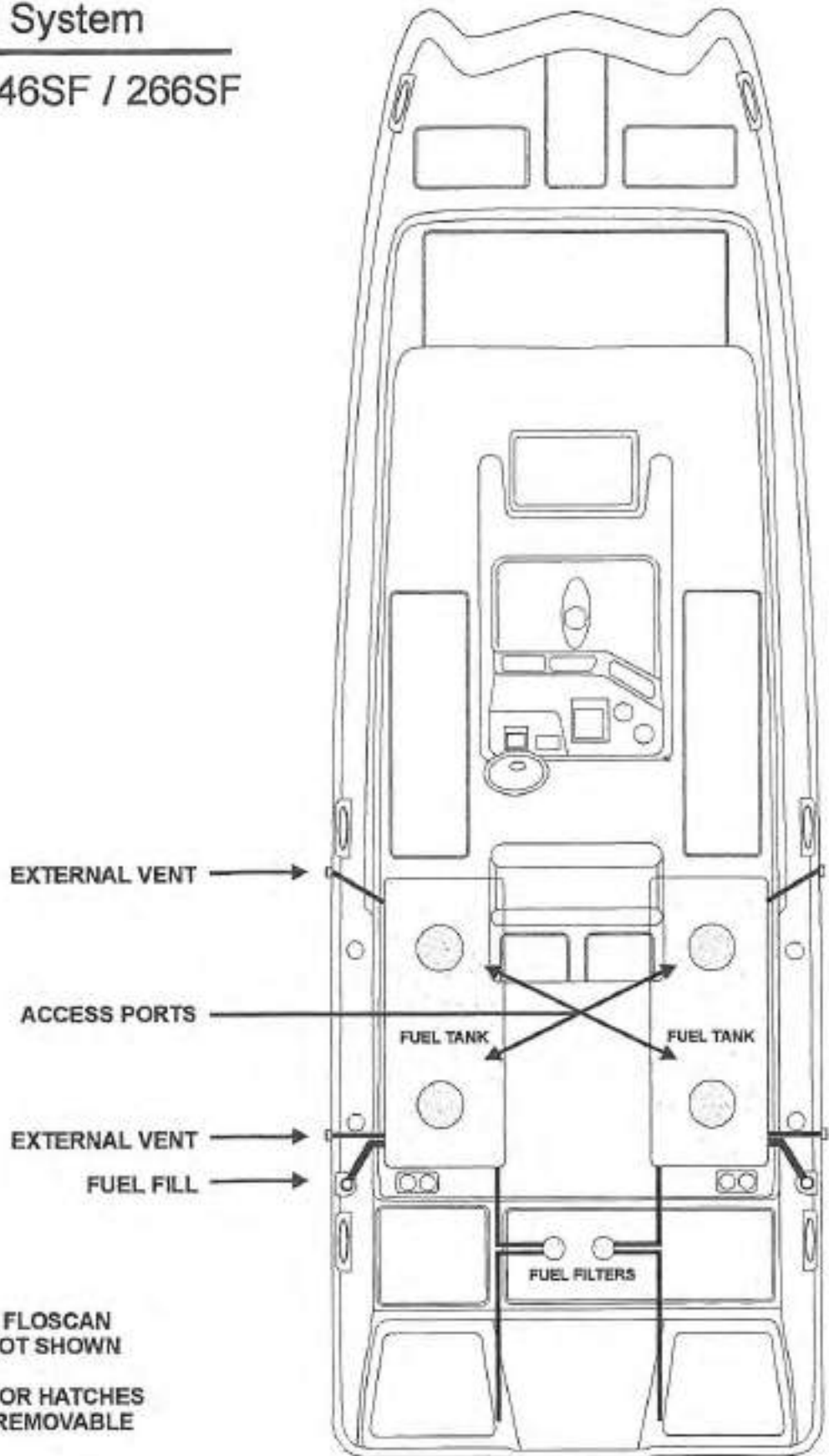

NOTES:

OPTIONAL FLOSCAN
DETAILS NOT SHOWN

226SF FLOOR HATCHES
ARE NON-REMOVABLE

Fuel System

266SC

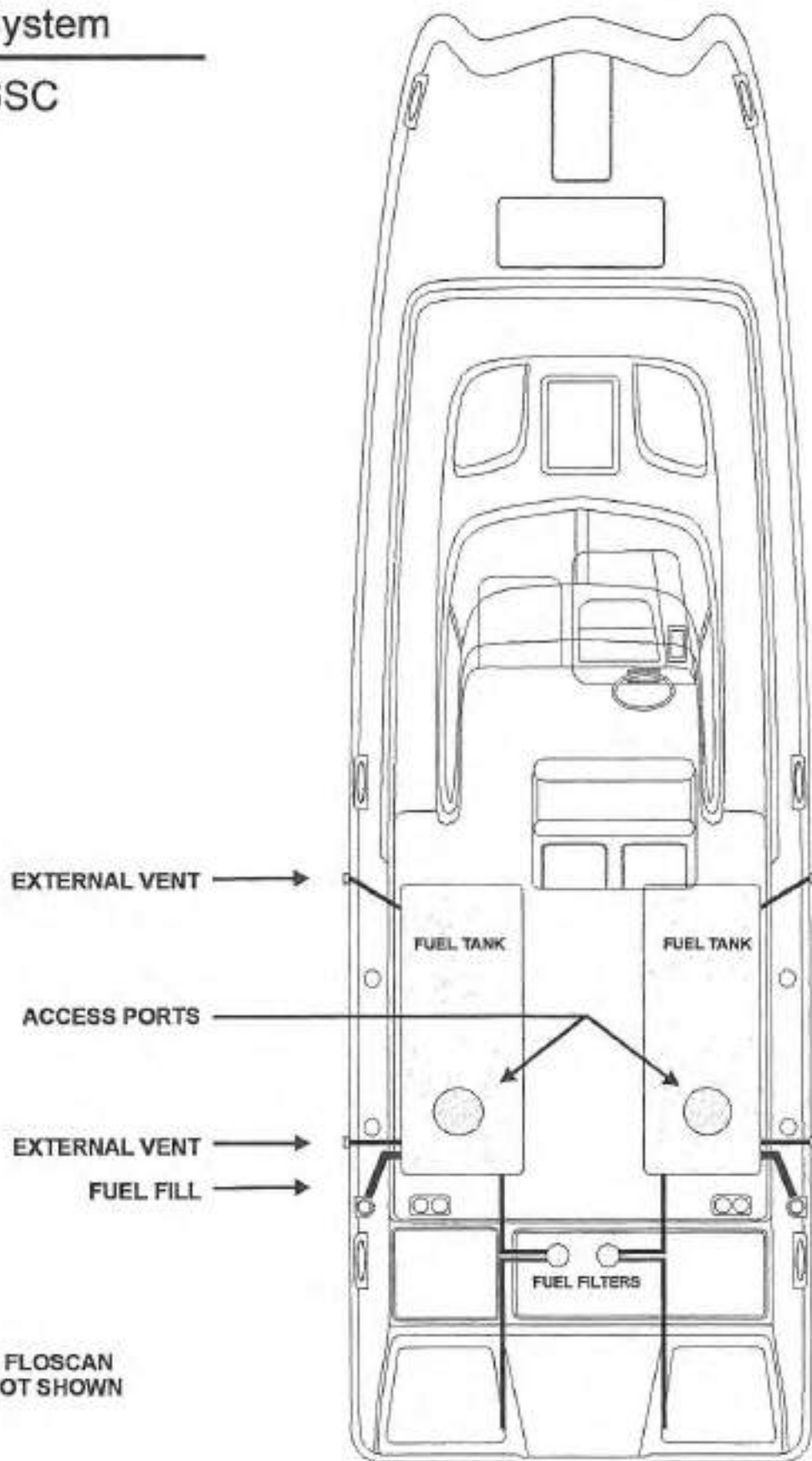

NOTE:

OPTIONAL FLOSCAN
DETAILS NOT SHOWN

Fresh Water System

246DC

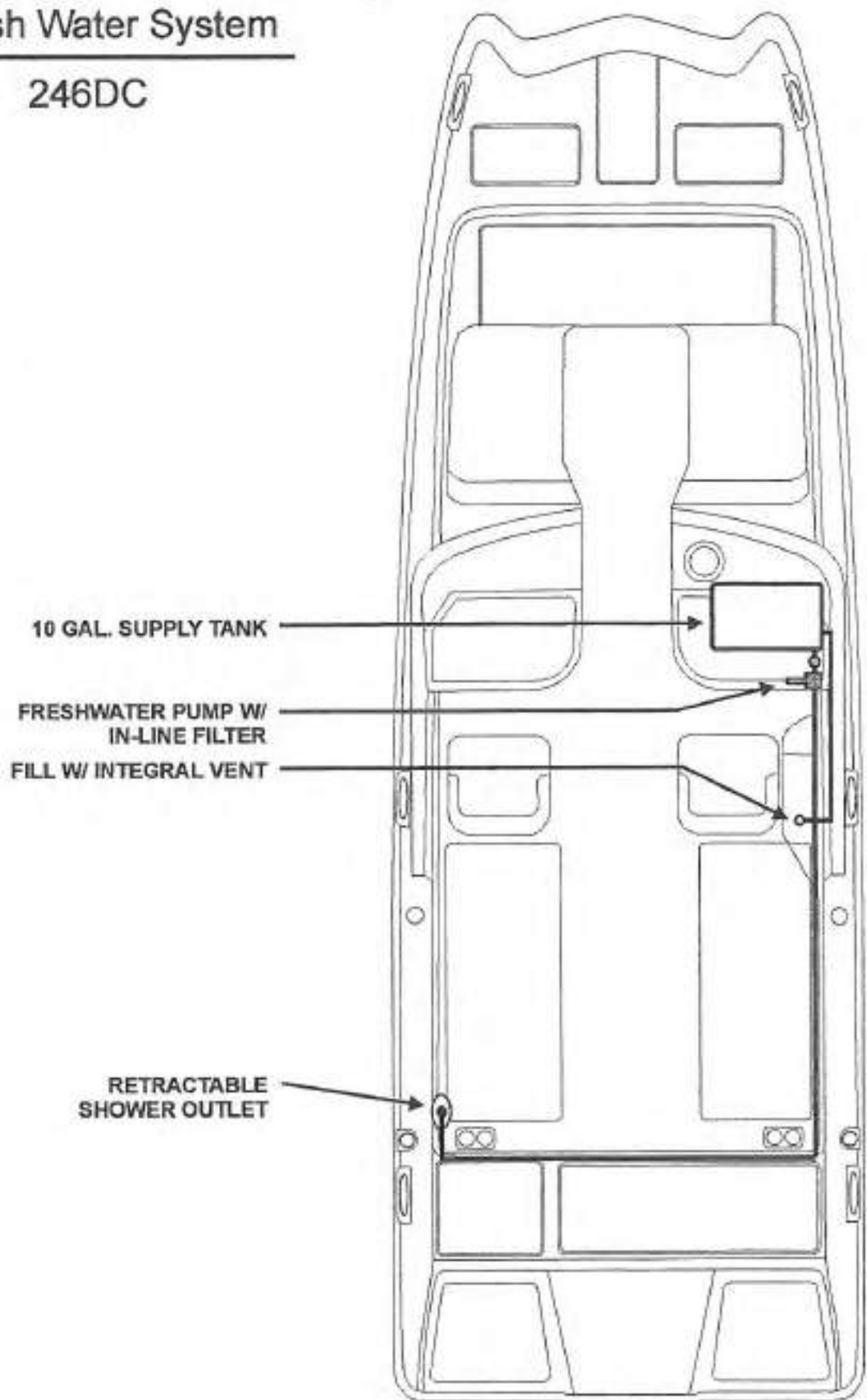

Fresh Water System
226SF / 246SF / 266SF

- FRESHWATER PUMP W/
IN-LINE FILTER
- RETRACTABLE
SHOWER OUTLET
- FILL W/ INTEGRAL VENT
20 GAL. SUPPLY TANK

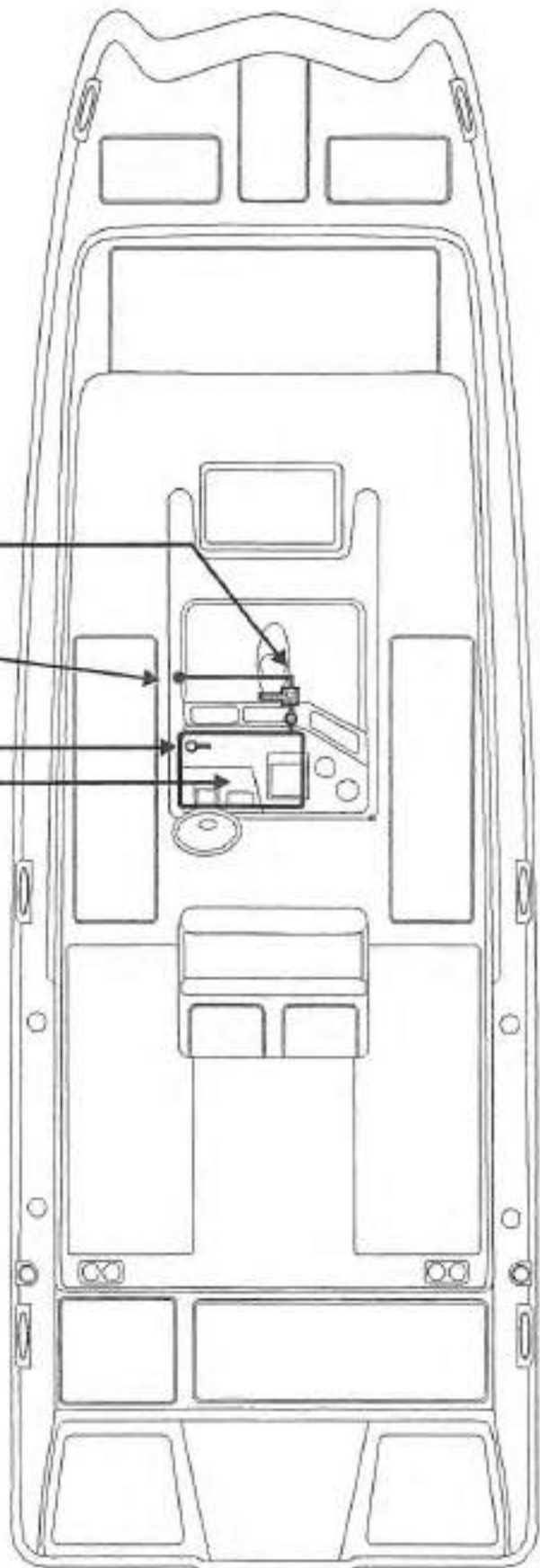

NOTE:

226SF HAS AN 8-GALLON
SUPPLY TANK

Fresh Water System

266SC

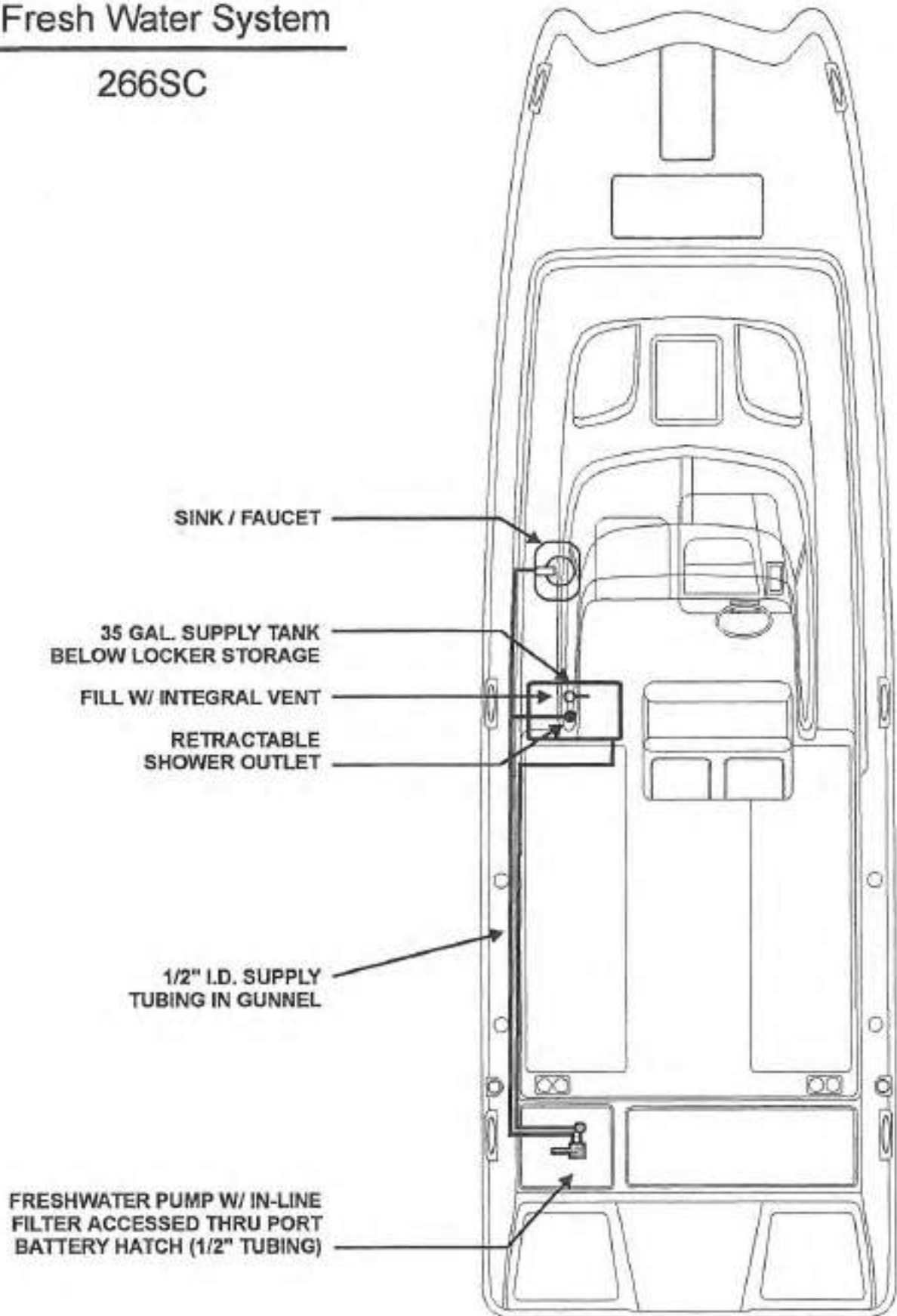

Raw Water System

246DC

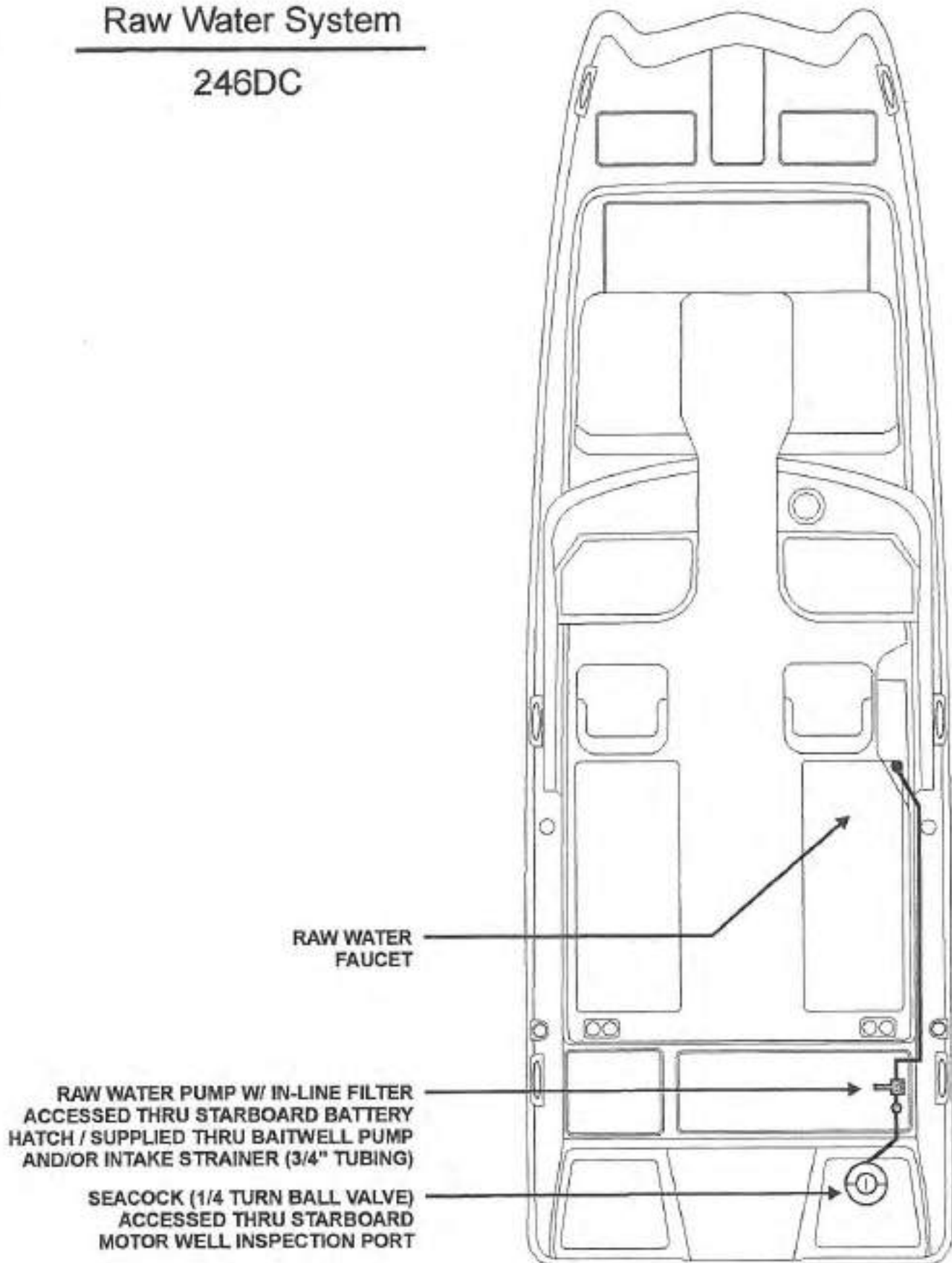

Raw Water System

226SF / 246SF / 266SF

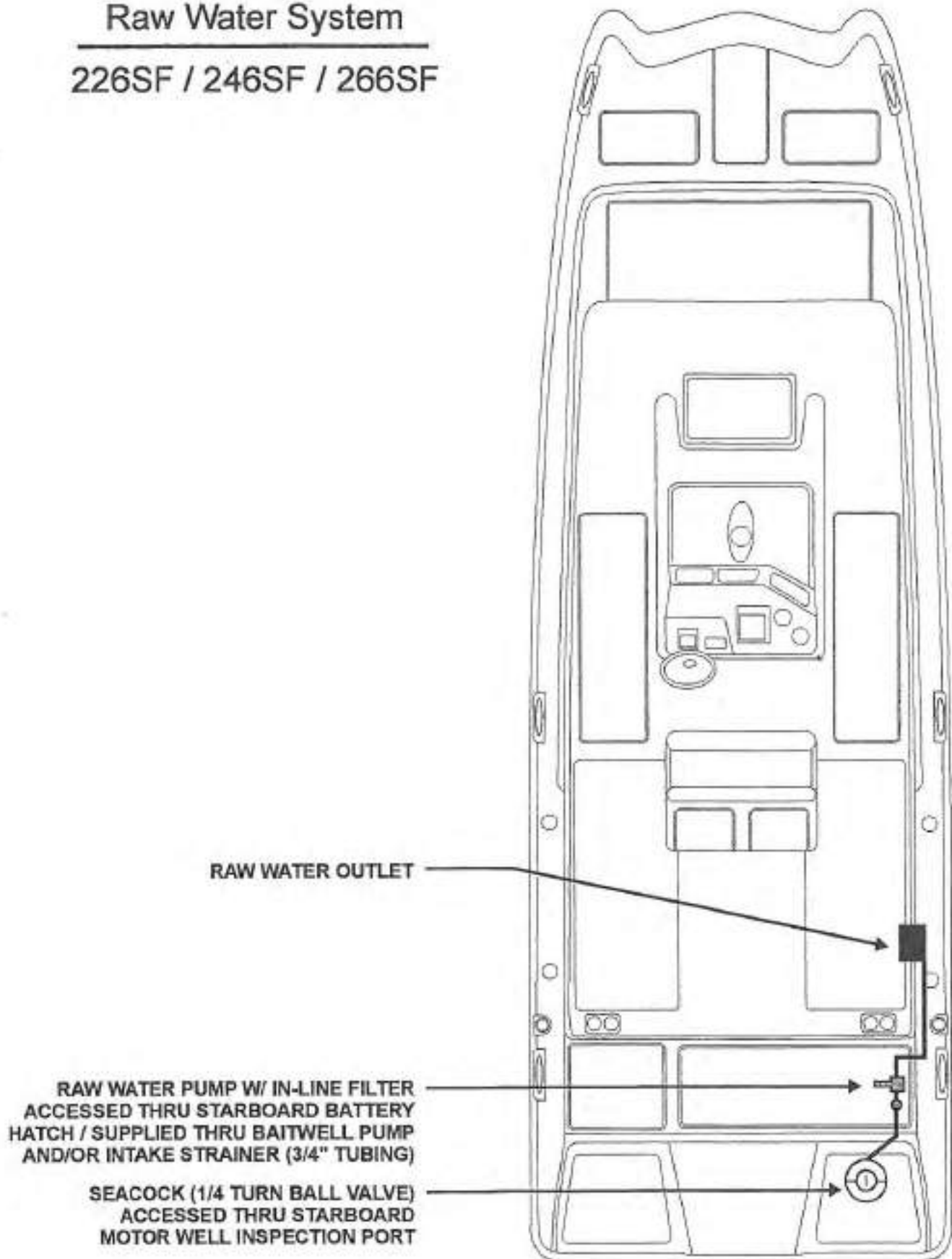

Raw Water System

266SC

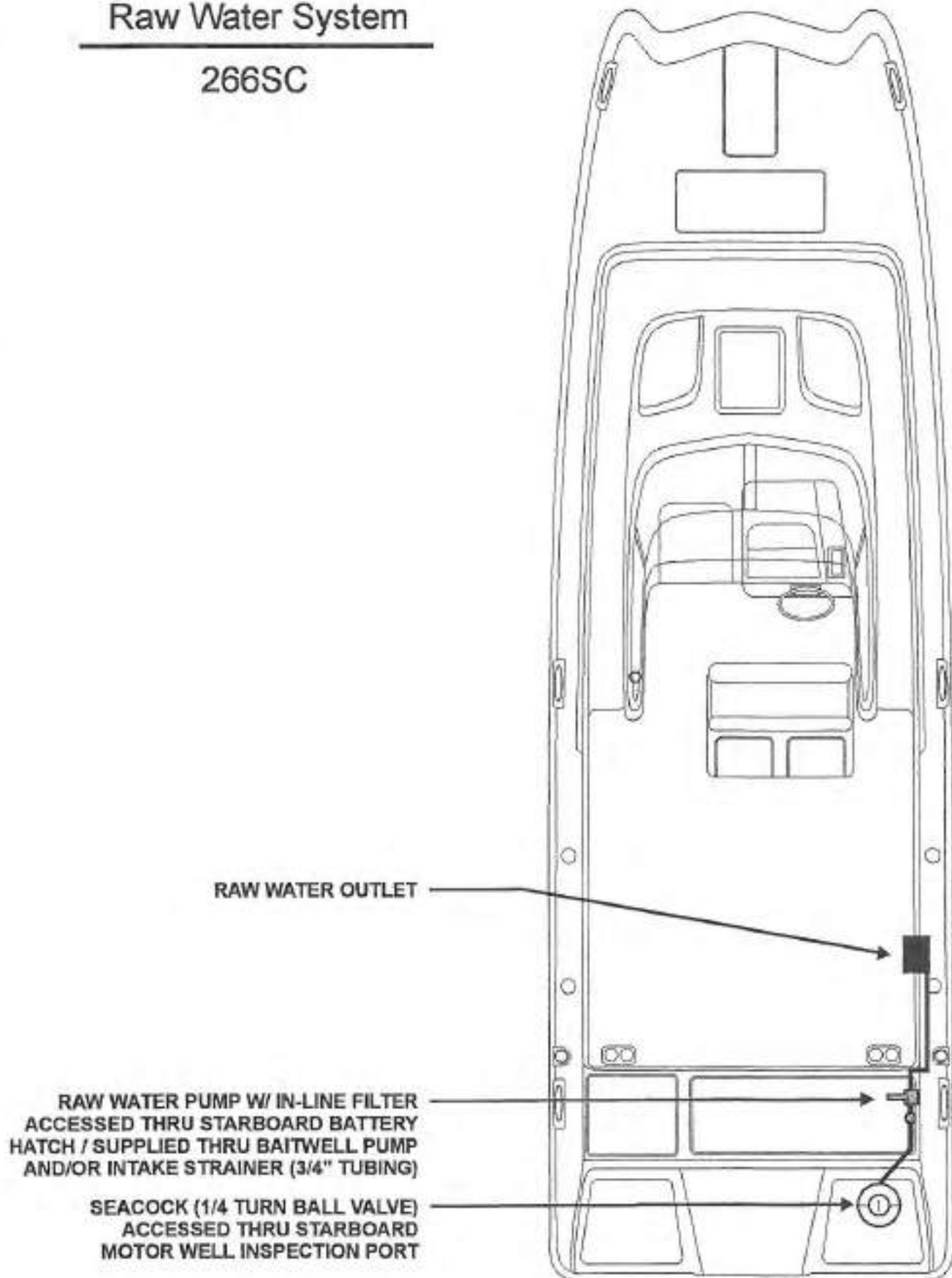

LIVEWELL OPERATION

The livewell is supplied by a SHURflo MAG-DRIVE BAIT SENTRY (model 800) pump located in the aft section of the starboard hull and accessible through the motor well inspection port. The pump draws from a bronze pick-up on the inside (tunnel side) of the hull. This pick-up also supplies the raw water washdown pump. A seacock is plumbed forward of both pump inlets. It can also be accessed through the same inspection port.

The livewell on all models has a 25 gallon capacity tank with a 1-1/8" over flow drain tube which is threaded into the bottom of the baitwell. When screwed all the way down, all of the water flows over the top of the tube. When partially screwed down, some water goes out through the bottom and helps keep fresh water moving from top to bottom. Care should be taken to ensure that enough water is coming into the tank that water still flows over the top of the drain pipe (water flow into the tank is controlled by the aerator head shut-off valve which is located inside the tank on the port side). To drain the tank, turn the intake water off and completely unscrew the drain pipe. When the baitwell is not being used, keep the aerator head shut-off valve in the OFF position. If left open, water may be forced into the baitwell when the boat is moving at a high rate of speed. Since this tank is insulated, it may be used as a cooler by plugging the drain.

NOTES & CAUTIONS

Ensure that the seacock and the flow adjustment valve are open before turning the pump ON.

When the boat is not in use, CLOSE the seacock.

If replacing the pump, DO NOT use a wrench to tighten the pump to the seacock. Hand-tighten only after application of a sealant to the pipe threads. Double clamp all connections below the water line.

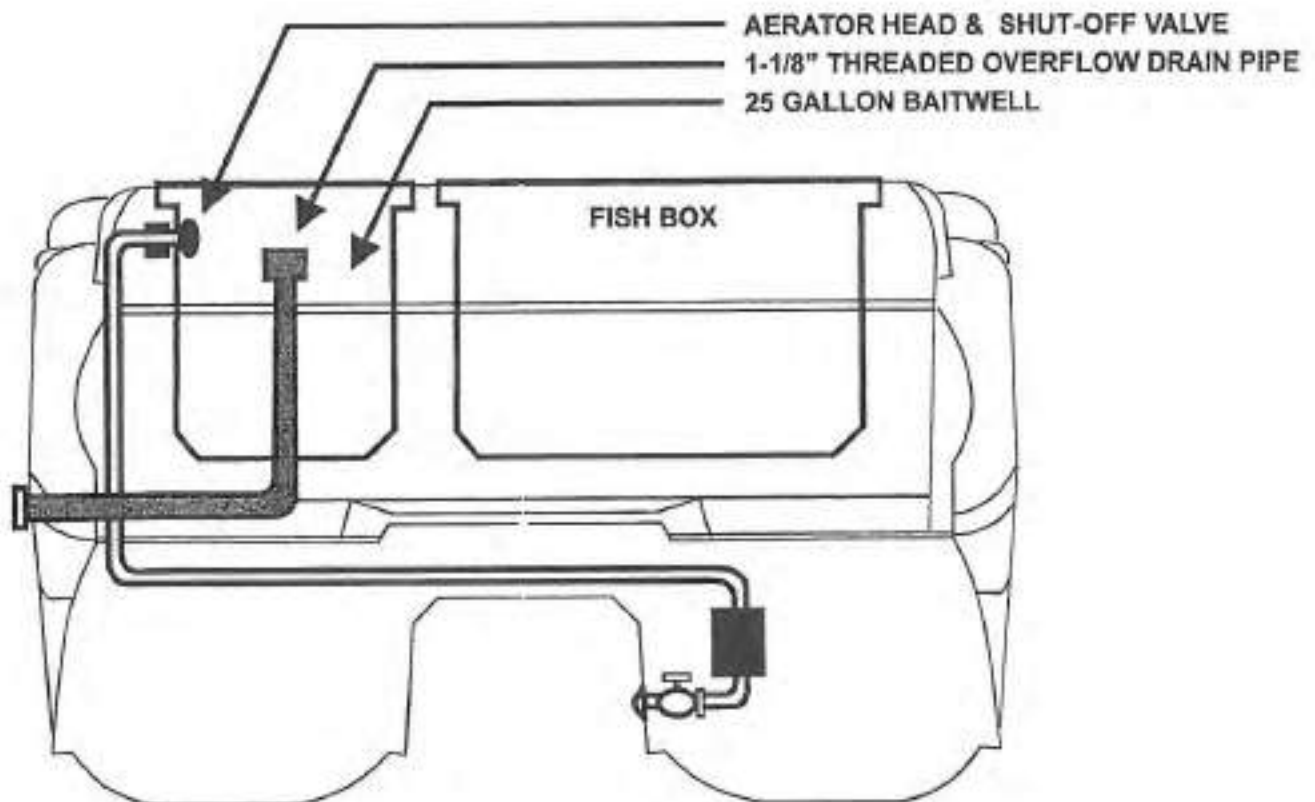

ELECTRICAL SYSTEM

The electrical system for each engine is isolated, except in emergencies when the battery parallel switch may be used to temporarily connect both sides (see below). Main power forward to the helm is provided by the starboard battery through a #6 ga. feed that is protected with a 50A re-settable circuit breaker in the starboard battery compartment. All accessories are supplied by the starboard battery, including the starboard and port bilge pumps in both manual and automatic modes. **CAUTION:** If additional batteries or battery switching devices are installed, ensure that the automatic side of the bilge pumps (wired independently from the main feed - see Wiring Code) remains directly connected to the battery system.

Battery Jumper Switch

The battery jumper switch is located in the starboard battery compartment. Its purpose is to provide a means of temporarily cross-connecting the port and starboard batteries in parallel to provide starting capability for either engine should the individual dedicated battery become discharged. If it becomes necessary to use the jumper switch, turn it to ON and start the engine on the discharged side. Turn the switch OFF (normal position) and start the other side. Operating both engines with the jumper switch ON may damage sensitive electrical components of one or both engines. **CAUTION:** The computer control systems of many outboard motors continually draw small amounts of current, even when not running. The batteries may therefore discharge completely if the boat is unused over an extended period (approx. 30 days). In such cases, use of a maintenance trickle charger is recommended, or optionally, disconnecting the batteries completely. Disconnection will not harm the control systems.

Battery Connection Warning

Disconnecting and reconnecting the battery while the engine is running by removing the battery cable(s) from the battery post(s) will cause an extremely high voltage variation to be produced on the 12 volt line. This voltage will likely cause immediate failure of instruments and any equipment which is operating at the time and may damage the alternators. Less obvious, yet just as destructive are loose, or bad connections between battery cables and battery posts caused by corrosion and/or frayed cables. Also included in this category are defective, cracked, or corroded battery switches and isolators. The possibility of damage is due to the fact that in almost all battery-started engine applications, the battery acts as a voltage limiter. As a preventative measure, battery terminals and clamps should be cleaned and tightened periodically. Cracked, corroded, or otherwise defective battery switches or isolators should be replaced.

Battery Capacity

Careful consideration should be given to the type of batteries you install in your boat. Many of today's outboard engines require batteries capable of delivering 1000 Marine Cranking Amps (MCA). The type of engines and the amount of electronics should be taken into consideration. Since the starboard battery is the "House" battery, a larger series battery may be recommended by your dealer.

UNDERSTANDING BATTERY RATINGS

* The following is reprinted with the permission of Exide Nautilus Batteries.

Ampere Hour Rating

This is the number of amps which a battery can deliver for a 20 hour period. This test is also referred to as the 20 hour rate. The larger the amp hour rating, the more power a battery can deliver over time.

Marine Cranking Amps (MCA)

This is the number of amps which a battery can deliver at 32 degrees Fahrenheit for 30 seconds and maintain at least a voltage of 1.2 volts per cell. This differs from cold cranking amps which are measured at 0 degrees Fahrenheit.

Reserve Capacity (RC)

This is the time, in minutes, for which a battery will deliver 25 amperes at 80 degrees Fahrenheit. This represents the time which the battery will continue to operate essential accessories in the event of alternator or generator failure.

DETERMINING THE AMPERE HOUR DRAW OF YOUR BOAT

In order to determine the ampere hour draw of your vessel, you need to know what electrical equipment you have and what the 12 volt amp draw is. The following is a listing of typical 12 volt equipment aboard most vessels and their average amp draw per hour. Additionally, the amp draws shown below are for "on time" while the batteries are being used. Remember, a refrigerator, fresh water pump, head macerator, etc. only draws power intermittently.

Simply add up the 12 volt accessories you have, multiply by 20, and that should give you a very good approximation of your boats amp hour battery requirement.

12 volt item	Amp draw
Bilge Pump (500 gph)	2.0
Bilge Pump (1000 gph)	2.9
Bilge Pump (1500 gph)	4.9
Bilge Pump (2000 gph)	8.4
Navigation Lights (3 mile)	1.5
Livewell Pump	7.0
Fresh Water Pump	4.0
Refrigerator (12 v.)	6.0
Icemaker	6.0
Head (Macerator)	9.0
Anchor Windlass (900 lb)	7.5
12 v. House Lighting	0.15 per 10 watts
Spot Lights (100K cp)	6.0
Spreader Lights (3K cp)	3.0
RADAR (24 mile)	6.0
GPS	0.8
LORAN	0.7
VHF Radio - transmit	6.0
VHF Radio - receive	0.5
Depth Sounder (LCD)	1.0
Depth Sounder (Color)	3.0
SSB - transmit	30

12 volt item	Amp draw
Inverters	
SSB - receive	2.5
Autopilot	5.0
Stereo (50 watt)	0.5
Fan	1.0
Trolling Motors	
24 lb thrust	27
30 lb thrust	30
36 lb thrust	36
42 lb thrust	40
55 lb thrust	55
* Inverters vary on 12 volt amp draw depending on 115 volts A/C draw. It is generally recommended by inverter manufacturer's that you have 20% of your inverter's wattage capacity in battery amp hour capacity. This should provide 1 hour of full inverter capacity. However, be sure to add additional 12 volt amp draws.	

BATTERY INSTALLATION AND MAINTENANCE

When installing a battery in your boat, it is important to use either a box or a tie down system to keep the battery stationary once underway. This will reduce unnecessary vibration. Make sure all connections to the battery terminals are tight. Loose wires will cause sparking and arcing which can melt wires or cause explosion. Additionally, it is important to coat the terminals and connections with a corrosion inhibitor. The corrosion inhibitor should be re-applied every several months. Failure to do this will result in poor connections and wire corrosion, especially in salt water environments. Corrosion increases the resistance in the wires requiring more amps to be drawn to run electrical equipment. When installing a new battery, be sure to remove any plastic battery terminal protectors before attaching wires. When storing a battery for winter, check and fill with distilled water as needed, recharge the battery fully, and store in a cool place. When preparing battery after winter storage, recharge the battery to its full charge state.

"WORLD CLASS CATAMARANS"

WIRING CODE FOR 226SF / 246SF / 266SF / 266SC

FUNCTION	COLOR	GAUGE	BREAKER/FUSE AMPS	BREAKER/FUSE LOCATION
BATTERY TO BATTERY JUMPER	RED	#4	NONE	N/A
HARNESS MAIN FEED	RED	#6	50A BREAKER	STARBOARD BATTERY COMPARTMENT
WINDLASS POWER (see Note 3)	RED	#6	50A BREAKER	STARBOARD BATTERY COMPARTMENT
WASHDOWN PUMP	BROWN/ORANGE	#14	15A BREAKER	PANEL
BILGE PUMP Manual X2 (see Note 2)	BROWN/BLUE- STBD. BROWN- PORT	#14	5A BREAKER (X2)	PANEL
BILGE PUMP AUTO X2 (see Note 2)	BROWN W/ WHITE STRIPE	#14	5A BREAKER (X2)	FUSE BLOCK
COCKPIT INTERIOR LIGHTS	BLUE	#14	5A BREAKER	PANEL
HORN	ORANGE W/ WHITE STRIPE	#14	10A BREAKER	PANEL
WIPER	ORANGE W/ BLACK STRIPE	#14	5A BREAKER	PANEL
WIPER PARK	BLACK W/ WHITE STRIPE	#14	N/A	N/A
NAVIGATION LIGHTING	GREY	#14	5A BREAKER	PANEL
ANCHOR LIGHT	GREY W/ WHITE STRIPE	#14	5A BREAKER	PANEL
BAITWELL PUMP	BROWN W/ YELLOW STRIPE	#14	5A BREAKER	PANEL
BAITWELL LIGHT	BLUE	#14	ATTACHED TO BAITWELL SW.	-----
FRESH WATER PUMP	BROWN W/ RED STRIPE	#14	10A BREAKER	PANEL
ELECTRIC HEAD	WHITE W/ BROWN STRIPE	#10	5A BREAKER	FUSE BLOCK
BOARDING LIGHTS	BLUE W/ WHITE STRIPE	#14	5A BREAKER	PANEL
STEREO	WHITE W/ RED STRIPE	#14	3A BREAKER	PANEL
STEREO CLOCK	WHITE W/ YELLOW STRIPE	#14	30A BREAKER	FUSE BLOCK
FUEL SYSTEM GROUND	GREEN	#14	N/A	N/A
12 VOLT POWER POINT	RED	#14	15A BREAKER	FUSE BLOCK
ALL GROUNDS (EXCEPT FUEL SYSTEM)	BLACK	#4-6-10- 14	N/A	N/A

INSTRUMENT WIRING

TACHOMETERS	GREY	#16	N/A	N/A
VOLTMETERS	PURPLE (FROM IGNITION)	#16	N/A	N/A
FUEL SENDERS	PINK /WHITE- STBD. PINK - PORT	#14	N/A	N/A
IGNITION	PURPLE	#16	N/A	N/A
INSTRUMENT LIGHTS	BLUE	#16	N/A	N/A

NOTES: 1 -All factory wiring is linned copper and conforms to ABYC Yacht specifications. 2 - For the 266SC & 266LC, Fwd bilge pumps have 5A breaker, aft pumps have 10A breaker. 3 - Pull string inserted in lieu of wiring for boats ordered w/o windlass.

GAUGE TROUBLESHOOTING QUICK REFERENCE GUIDE

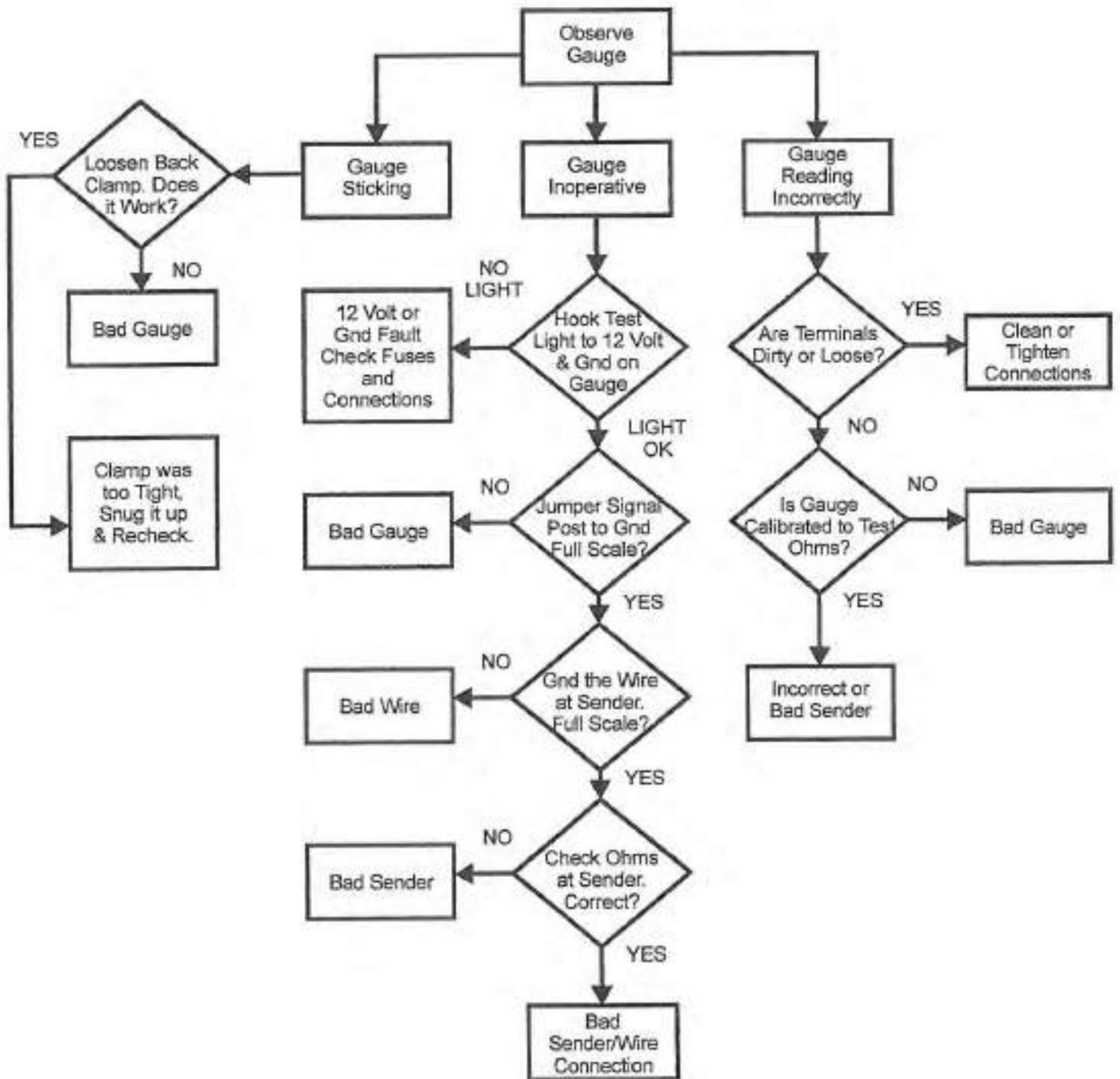

MARINE INSTRUMENTATION -- GENERAL FACTS

Meter Movement Stops

Some marine tachometers have no internal meter stops which therefore permit 360 degrees of pointer movement. When the ignition is shut off, the pointer will fall to approximately to the 6 o'clock position. When the ignition is switched back on, the pointer will go to zero and then to the correct RPM when engine is started.

Other models will stop on zero with no power applied, but have the potential for pegging at the maximum RPM's if the switch on the back of the tach is between positions.

To remedy this, the engine is started and revved up to RPM's higher than mid-range. This will allow the tach to re-synchronize itself and operate normally. The tach can also be shut off, and a magnet used on the face of the lens to return the pointer to zero. Either of these methods can be used (with switch on back of the tach in the correct position) to return to normal operation.

Lens Fogging

Most marine instruments have small vents in their cases to allow a way out for moisture that finds its way in. It is possible for moist air to be drawn into vents when the air inside the tachometer or gauge cools down after the instrument is turned off. The morning sun can draw this moisture up against the lens, causing fogging. This same sun will help force the moisture back out of the instrument as well. Running with the instrument lights "on" can also speed up moisture removal. Fogging is not abnormal, nor will it harm your instruments, which are built to withstand a harsh environment.

Radio Transmissions

Some interference (erratic operation) may be noticed on tachometers during radio transmissions. This will neither damage the instrument nor affect its accuracy when not transmitting.

TACHOMETERS

Operation

Electronic tachometers work by counting pulses generated by the ignition system or alternator. The tach is hooked up to + 12VDC, Ground, and one of the signal sources listed above. By selecting the right tach and setting the switch on the back to the correct position, you let the tachometer know how many pulses are being sent per engine revolution. From this information, the tach displays the correct engine speed. Instrument part numbers are located on a label attached to the outside of the case (i.e. TC0000A).

Application

4 cycle engines: The tach signal terminal is connected to the negative terminal on the ignition coil or to a transistorized tach driver circuit connected to the ignition system. This circuit will have a wire (usually gray) for connection to the tach. The correct tachometer will have a white label on the side indicating which switch position is for each engine type. This label will include 4, 6, and 8 cylinder engines for positions 1, 2, and 3.

2 cycle engines: The tach signal terminal is usually connected to the unrectified AC output of the alternator/lighting coil. Sometimes it is hooked directly to the stator output wire (usually yellow) other times a gray tach output lead is provided. The correct tach for this application will have a white label on the side with switch positions for 4, 6, 8, 10, 12, or 20 pole alternators.

Calibration

Set up a calibrated "shop tach" or "strobe tach" to monitor the engine's true RPM. Start the engine and (after an appropriate warm-up period and with the shift in neutral) increase it's speed to the boat's normal cruising RPM read on the shop tach. Set the coarse adjustment switch to the proper position described on it's label. Remove the stop-plug or paper label corner (at the 8-o'clock position on the rear of the case for most) and insert a 5/16" Allen wrench into the "fine adjustment" trim pot, rotating it CW or CCW as necessary to indicate the true RPM.

Troubleshooting

Symptom recognition is the first step in effective instrumentation troubleshooting. Tachometers usually exhibit the following symptoms:

A) **Dead** - This is usually caused by: 1) No power applied, 2) No signal supplied, or 3) tach damaged by electrical transients caused by disconnecting the battery with the engine running.

1) Check to see if power is applied to tach by switching the instrument supply switch on and off. As power is applied, the pointer should jump slightly. If it does not, check to see that the wires are installed on the correct terminals and that 12 volts are actually applied to the terminals themselves.

2) If tach indicates that power is applied, check for the presence of a signal on the signal terminal. Measure the signal between the signal and ground terminals. This should read in excess of 2 volts DC.

3) If power and signal are present, then it is possible that the tach has been damaged by electrical transients.

B) **Pegged** - This condition occurs on tachs with internal mechanical pointer stops. It is caused by removing power from the tach while it is running in excess of mid-scale RPM's or by the switch on back of the tach being in between positions. When power is re-applied, the tach pointer attempts to go clockwise to zero but cannot because the internal stop is in the way. Read "Marine Instrumentation General Facts" on the previous page for details on how to correct this condition.

C) **Erratic** - This symptom is caused 99% of the time by an intermittent connection between the wire and the ring or spade connector. Often the wire's insulation is pushed into the crimp area and crimped. The center conductor casually touches the connector allowing the tach to work most of the time but causing a nightmare for the technician. Electrical noise also can cause erratic readings. See "Reading High" below for further information.

D) **Reading High** - This is usually caused by the switch on the back of the tach being in the wrong position. If the number of cylinders or alternator poles selected by the switch is too low, the tach will read high. If a variable alternator or magnetic pick-up tach is being used, then further calibration may be necessary, as this calibration is done by the end user. See "Calibration". Excessive electrical noise may also cause the tach to read high. These noise spikes are counted by the tach as engine RPM's. The wire affected by the noise can be identified by connecting one wire at a time to the tachometer directly from the battery or the signal source on the engine.

FUEL GAUGES

Operation

Gauges operate by sending a low amperage current through the gauge's meter to ground via a sending unit with variable resistance. The resistance of the sending units increase or decrease with the changes in volume. As the sender's resistance varies, the amount of current allowed to flow through it to ground changes and the meter deflects. Instrument part numbers are located on a label attached to the outside of the case (i.e. GA0000A).

Troubleshooting

A) Gauge appears to "stick" during operation - Slightly loosen nuts holding back clamp and check operation. If gauge now operates properly and is not loose in panel, gauge now should provide suitable service. If gauge continues to stick during operation – replace gauge.

B) Gauge is inoperative:

1) To test for voltage to the gauge (use a 12-volt test light or voltmeter for testing):

a) Turn key switch to ON position. Connect the test light or voltmeter lead to the ignition "I" terminal of the gauge and the other lead to the ground "G" or "GND" terminal of the gauge. If test light lights or approximately 12 volts is indicated on the test meter, the ignition and ground connections are good.

b) If test light does not light or there is no reading on the test voltmeter, check the positive 12 volt power source at the key switch or fuse block. If no power is available at those points, correct the lead problem or replace any blown fuses.

c) If test light still does not light or voltmeter still shows no voltage, check ground wire and connections by connecting one lead of test light or voltmeter to a known source of B(+) and the other lead to the ground terminal of the gauge. If lamp lights or voltage is indicated on the voltmeter while touching the ground terminal of the gauge, the ground connection to the gauge is good. If lamp does not light or voltmeter does not show voltage, check ground connection to gauge and connection to ground source.

2) To test gauge operation and sending unit connections:

a) Turn key switch to OFF position. Connect a jumper lead between the "S" terminal and the "G" or "GND" terminal of the gauge. Turn key switch to ON position. If the gauge registers a full scale reading under those conditions, the gauge is good. If less than full scale reading is indicated, the gauge is defective and should be replaced.

b) If no reading is indicated, remove sending unit lead wire from sending unit on the engine. Turn the key switch to the "ON" position. Ground the sending unit lead wire to a good ground and note the gauge reading. If the gauge registers a full scale reading the sending unit may be defective.

c) Remove jumper lead. Remove sending unit lead wire from the sending unit on the fuel tank. Turn key switch to ON position. Ground the sending unit lead wire to a good ground and note the gauge reading. If the gauge now (after grounding the sending unit lead wire) registers a full scale reading, the sending unit is defective and should be replaced. NOTE: Intermittent readings usually indicate loose connections or shorted wiring. Check all connections and wiring if the above checks do not pinpoint a specific defect.

C. Sending Unit is defective - Disconnect sending unit lead from gauge "sender" terminal. Using ohmmeter, test sending unit resistance. If sending unit shows EITHER zero ohms or open circuit, check sending unit or wiring for defects.

VOLTMETERS

Operation

A voltmeter indicates the battery voltage and the general condition of the battery charging system. The meter requires no warm-up and indicates voltage changes instantly. Instrument part numbers are located on a label attached to the outside of the case (i.e. VP0000A).

Troubleshooting

A) Gauge appears to "stick" during operation - Slightly loosen nuts holding back clamp and check operation. If gauge now operates properly and is not loose in panel, gauge now should provide suitable service. If gauge continues to stick during operation, replace gauge.

B) No voltage reading is noted on the voltmeter:

1) If the indications are normal (engine starts, lamps lights, etc.) proceed with this test, otherwise, check battery voltage with a test voltmeter, or a 12 volt test light.

2) Check for voltage at voltmeter by connecting test voltmeter or 12 volt test light to "+" and "-" terminals of voltmeter; turn ignition switch on.

a) If light does not light, or if test voltmeter reads the same as installed voltmeter, the problem is in the battery charging system or wiring. Refer to the outboard motor manufacturer's shop manual for trouble-shooting procedure.

b) If test voltmeter indicates correct voltage; typically 14 volts with engine running and at least 12 volts with no accessories on and engine off (see outboard motor shop manual for details), then replace voltmeter.

WATER PRESSURE GAUGES

Operation

Gauges indicate cooling system pressure and proper operation of water pumps and thermostats. A sudden drop in pressure indicates that a foreign object (plastic bag, seaweed) is obstructing the water intakes. The gauges are directly supplied by tubing connected to each outboard (make sure hose to gauge is secured with tie to prevent water spray) – No sending unit is utilized. Instrument part numbers are located on a label attached to the outside of the case (i.e. WP0000A).

Troubleshooting

A) Gauge appears to "stick" during operation - Slightly loosen nuts holding back clamp and check operation. If gauge now operates properly and is not loose in panel, gauge now should provide suitable service. If gauge continues to stick during operation – replace gauge.

B) Gauge is inoperative - Remove tubing from affected gauge. Start outboard and check for water flow at the gauge end of the tubing (This may take a few seconds). If there is no water flow, check for proper water pump and thermostat operation, a loose tubing connection at the outboard or a kink in the tubing line. If all of these are normal – replace gauge.

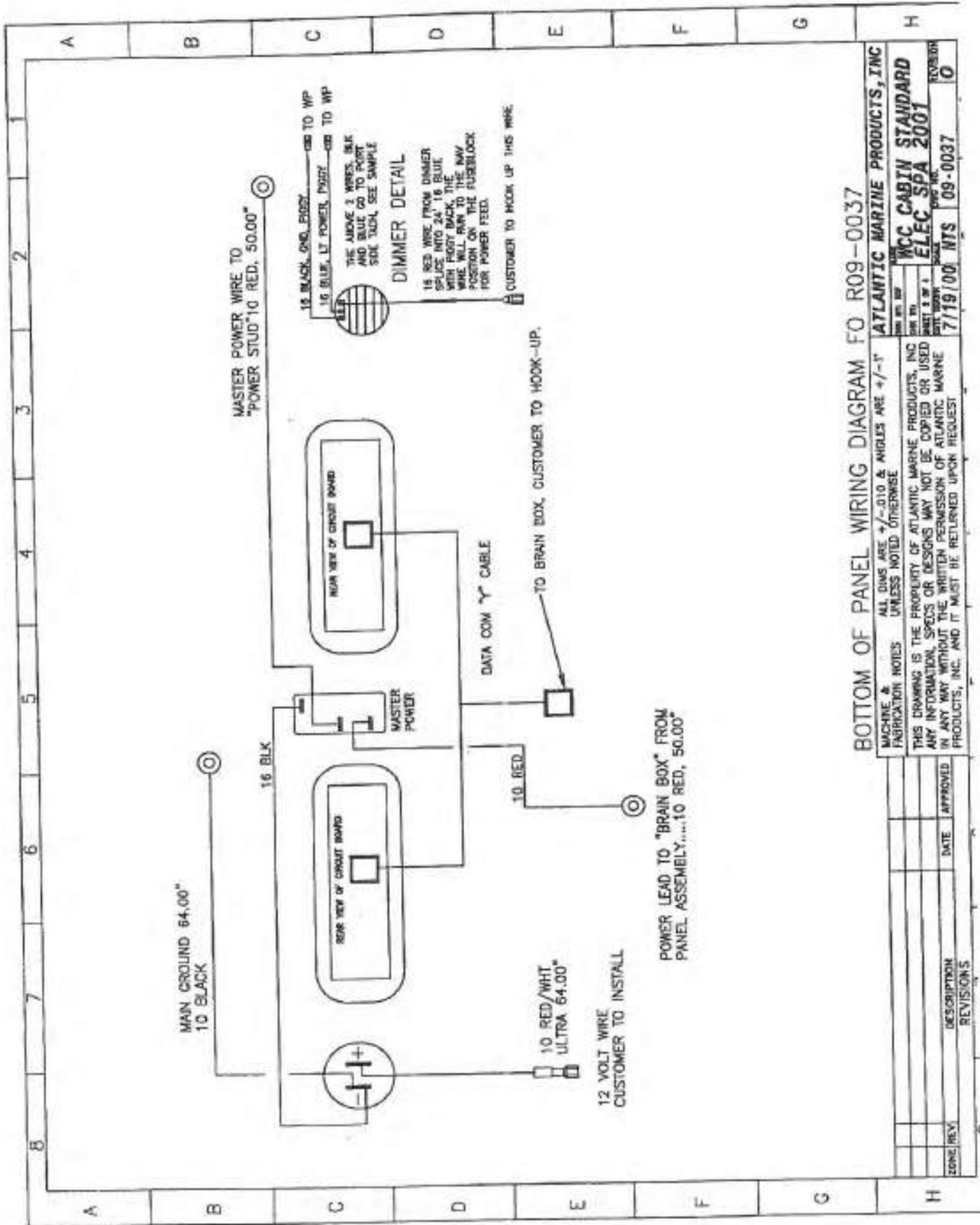

BOTTOM OF PANEL WIRING DIAGRAM FO R09-0037

ZONE	REV.	DESCRIPTION	DATE	APPROVED

MACHINE & NOTES		ALL DIMS ARE +/- .010 & ANGLES ARE +/- 1° UNLESS NOTED OTHERWISE	
THIS DRAWING IS THE PROPERTY OF ATLANTIC MARINE PRODUCTS, INC. ANY INFORMATIONAL, SPECS OR DESIGNS MAY NOT BE COPIED OR USED IN ANY WAY WITHOUT THE WRITTEN PERMISSION OF ATLANTIC MARINE PRODUCTS, INC. AND IT MUST BE RETURNED UPON REQUEST			
FABRICATION		ATLANTIC MARINE PRODUCTS, INC.	
DATE	7/19/00	MTS	09-0037
REV.	0	REV.	0

Horizon 600

H600-12V

A + B + C + D + E =		
10.7 m (35 ft)	19.8 m (65 ft)	27.4 m (90 ft)
8 mm ² (8 AWG)	10 mm ² (6 AWG)	16 mm ² (4 AWG)

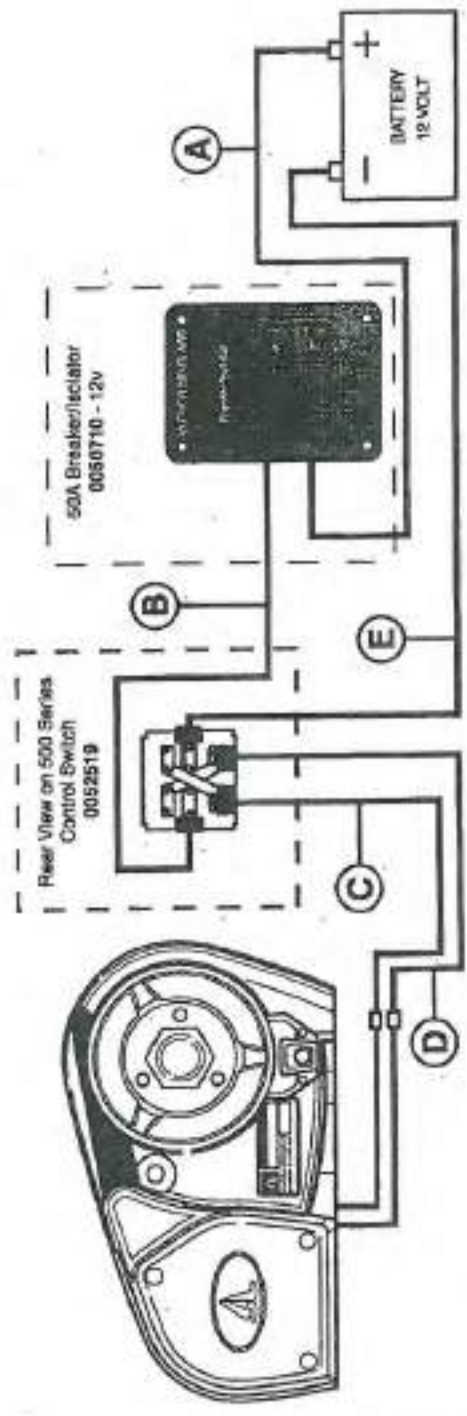

- Choice of cable thickness depends on total cable length; A + B + C + D + E =
- Battery to wirelöss, vindlöss to battery.
- Wahl des Kabeldurchmessers hängt ab von Gesamtkabelänge; A + B + C + D + E =
- Von Batterie zur Ankerwinde und von Ankerwinde zur Batterie.
- Le choix d'épaisseur de câble dépend de la longueur totale du câble; A + B + C + D + E =
- Refaire la batterie au guinçois et le guinçois à la batterie.
- La elección del grosor del cable depende de la longitud total del mismo; A + B + C + D + E =
- Desde la pila o batería, hasta el cable hasta el cable hasta la batería.
- La scelta dello spessore dei cavi dipende dalla lunghezza totale del cavo stesso; A + B + C + D + E =
- Dalla batteria dell'argano, dell'argano alla batteria.
- Val av kabelþykuleik berir på den totala kabellengd; A + B + C + D + E =
- Frán batterí til ankerþöfl. Frán ankerþöfl til batterí.

Simpson Lawrence Horizon 600 Windlass

Operation and Maintenance Guide

The Simpson Lawrence Horizon 600 Windlass installed on your boat is an automatic rope/chain anchor windlass. The unit is operated with a toggle switch located at your helm station. This toggle operates the windlass in both the up and down direction. The following is a brief discussion on the use of the windlass; however, this is an important piece of equipment and the instruction manual should be carefully read.

* Pull string inserted in lieu of wiring for boats ordered without windlass.

Anchoring

- 1- Before anchoring, the retaining clip that is attached to your chain should be released to allow free running of the anchor rode.
- 2- Release the anchor and rode by pressing on the toggle switch. Allow the line to run out to an appropriate length for the depth of water where you are anchoring. Pausing periodically will allow your boat to drift back, both setting the anchor, and allowing the slack to come out of your anchor rode. It is recommended that the up switch be operated briefly to engage the internal clutch mechanism.
- 3- When your anchor is secure, and you have let out the proper amount of scope you should tie off your rode to a cleat. This provides a safe holding point for the boat. Although the windlass may hold the boat, it is always best to tie your rode off for long periods of time, preventing excess strain on the windlass.

Anchor Retrieval

- 1- When you are ready to pull up your anchor, untie your rode, to allow the windlass to retrieve the anchor rode.
- 2- Although the windlass is designed to pull more than the weight of the anchor and rode, it is best to assist it by using your engines. The speed of your boat should be consistent with both wind and current, making sure that you are not driving over the rode as the windlass retrieves it.
- 3- During anchor retrieval, the rode may begin to pile up beneath the windlass motor. Obstructions in the locker can prevent the rode from sliding into the deepest part of the locker. The rode may jam the windlass, and cause the windlass to stop if it piles up high enough. To prevent any complications during the retrieval of your anchor it is recommended that the line be cleared from beneath the windlass approximately every 50 feet.
- 4- When it is time to break the anchor loose from the bottom, you should always use your engines to assist the windlass.
- 5- Care should be taken, when you reach the chain section of your rode, to slow your retrieval down to prevent the anchor from overriding the anchor roller.
- 6- When the anchor is up and safely in the anchor roller, replace the retaining clip to ensure safe operation of your boat.

Other Tips

- 1- To help in anchoring and retrieval, it is good to mark your rode with an oil based paint every 50 feet to allow a visual guide to the amount of rode that is released. It is also beneficial to mark the last few feet of the chain to indicate when the anchor is about to enter the roller.
- 2- If the unit jams, it can be cleared by operating in the opposite direction releasing the kink in the rode or any obstructions. Sometimes it may be necessary to inspect the rope for kinks in order to prevent any jamming of the windlass.

Maintenance

The windlass is designed to operate in the marine environment, however, like any equipment that is exposed to salt water, it should be rinsed with fresh water. Rinsing the unit on a regular basis will prevent salt deposits, which may lead to poor operation of the unit, or corrosion. See your owners manual for more detailed maintenance procedures.

MINIMUM WEIGHT REQUIRED FOR TRAILER BRAKES (As of 1/1/98)

The requirements for trailer brakes are currently controlled by individual state statutes. On tandem trailers, only five states now require brakes on each axle - **Colorado, Pennsylvania, Minnesota and Washington** (and **Arizona** above 6000#). It is recommended that you contact your own state agency to confirm current requirements before purchasing a boat trailer.

State	Weight	State	Weight
Alabama	3,000#	Montana	3,000#
Alaska	5,000#	Nebraska	3,000#
Arizona	3,000#	Nevada	1,500#
Arkansas	3,000#	New Hampshire	1,500#
California	1,500#	New Jersey	3,000#
Colorado	3,000#	New Mexico	3,000#
Connecticut	3,000#	New York	3,000#
Delaware	4,000#	North Carolina	1,000#
Florida	3,000#	North Dakota	ALL
Georgia	2,500#	Ohio	2,000#
Hawaii	1,500#	Oklahoma	3,000#
Idaho	3,000#	Oregon	3,000#
Illinois	3,000#	Pennsylvania	3,000#
Indiana	3,000#	Rhode Island	4,000#
Iowa	3,000#	South Carolina	3,000#
Kansas	NONE	South Dakota	3,000#
Kentucky	NONE	Tennessee	3,000#
Louisiana	3,000#	Texas	4,500#
Maine	3,000#	Utah	2,000#
Maryland	3,000#	Vermont ^(Ref #1)	3,000#
Massachusetts	10,000#	Virginia	3,000#
Michigan	3,000#	Washington ^(Ref #2)	3,000#
Minnesota	3,000#	West Virginia	3,000#
Mississippi	2,000#	Wisconsin	ALL
Missouri	NONE	Wyoming	6,000#

Ref #1 If over 7 feet high & 7 feet wide

Ref #2 Or, if trailer exceeds 40 percent of tow vehicle weight

* Source: Boating Industry 12/97

**WCC exclusively endorses Float-On Trailers, Inc. For use under WCC products.
For more information please contact Float-On at (561) 569-4440.**

ZONE	REV. NO.	DESCRIPTION	DATE	APPROVED

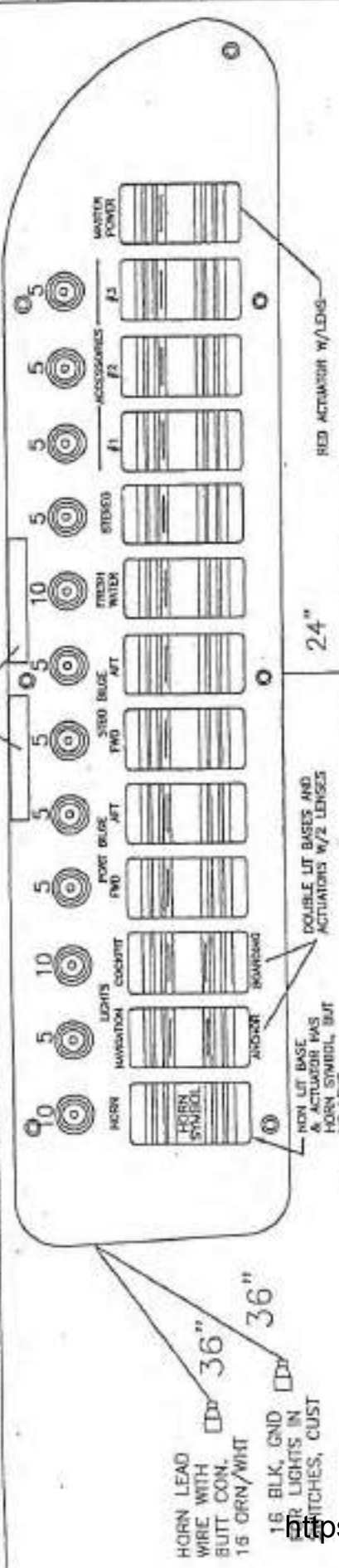

CUSTOMER LOGO

36"

24"

DOUBLE LIT BASES AND ACTUATORS W/2 LENSES

RED ACTUATOR W/LENS

BUSS BAR, SEE DETAILS ON SEPERATE PAGE

ASSEMBLY PARTS:

- CALLING CONTURA III ROCKERS WITH ACUATORS, LIT AND NON LIT BASES, AND 4 STYLES OF ACUATORS BASES ARE AS FOLLOWS:
- N/A, BOARDING, DPDT ON-OFF-ON, DOUBLE LIGHTS, VJD1D668-00000-000 (2 REQ'D)
- HORN, SPST OFF-MOM, NON LIT, V2D1S00B-00000-000 (1 REQ'D)
- ALL OTHERS, SPST, OFF-ON, LIT, V1DAB60B-00000-000 (10 REQ'D)
- ACUATORS ARE AS FOLLOWS:
- N/A, BOARDING HARD BLACK, 2 RED LENS, WCNCOO, (2 REQ'D)
- MASTER, HARD RED, 1 LENS, WCM500, (1 REQ'D)
- HORN, HARD BLACK, HORN SYMBOL, NO LENS, WZCXX-XHN3 (1 REQ'D)
- ALL OTHERS, HARD BLACK, 1 LENS, WCMCOO, (9 REQ'D)
- CIRCUIT BREAKERS ARE MPI THERMAL TRIP FREE PUSH TO RESET
- 5 AMP, 1680-217-050-97, (9 REQ'D)
- 10 AMP, 1680-217-100-97, (3 REQ'D)
- CLEAR BOOTS FOR CIRCUIT BREAKERS, C1221/24-4-CLEAR, (12 REQ'D)
- TAPE FOR BACKSIDE OF PANEL, APPROX 45", PE1612 X 1/2
- BUSS BAR PANEL, MACHINED & SCREENED, NAF013A (1 RE'QD)
- 20 GANG BUSS BAR, GEN AUTO, FS58472AT, (1 REQ'D)
- SPLIT TUBING ON HRNS, SEE CUTSHEET
- PANEL, MACHINED & SCREENED, NAF022 (1 REQ'D)

NOTES

- JUMPERS AND PREWIRE SHOULD BE TAKEN FROM CUTSHEETS AND BE PLACED PER SAMPLE.
- SEE SEPERATE DRAWING FOR THE WIRING OF THE NAV-ANC SWITCH, MASTER SWITCH & BOARD/COCKPIT SWITCH, ALSO SEE SAMPLE.
- SEE WIRING DIAGRAM FOR PROPER PLACEMENT OF ALL WIRES

FINAL ASSEMBLY PART NUMBER 09-0020

CUSTOMER PART NUMBER = 21-XXX

MACHINE & FABRICATION NOTES		ATLANTIC MARINE PRODUCTS, INC	
ALL DIMS ARE +/- .010 & ANGLES ARE +/- 1°	UNLESS NOTED OTHERWISE	DATE BY	NO. OF SHEETS
FINISHED EDGES ARE INDICATED BY FINISH MARK	PERIMETER EDGES ARE TO BE FINISHED, BREAK ALL SHARP EDGES AND CORNERS, PARTS ARE TO BE CLEAR AND FREE OF DEBRIS.	DATE DRAWN	NO. OF SHEETS
		4 JUNE 97	1:1 09-0020

THIS DRAWING IS THE PROPERTY OF ATLANTIC MARINE PRODUCTS, INC. ANY INFORMATION, SPECS OR DESIGNS MAY NOT BE COPIED OR USED IN ANY WAY WITHOUT THE WRITTEN PERMISSION OF ATLANTIC MARINE PRODUCTS, INC. AND IT MUST BE RETURNED UPON REQUEST

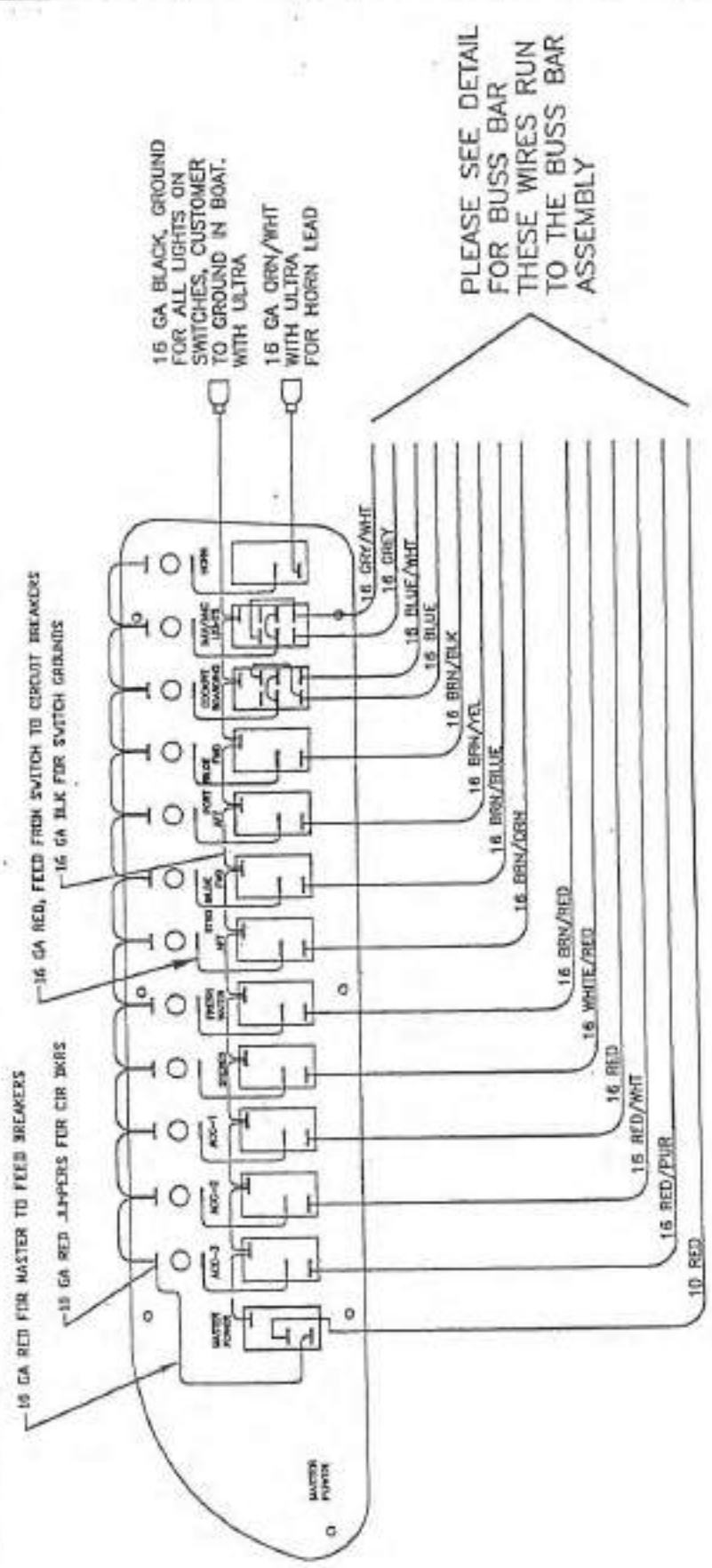

NOTE
 ALL WIRING DETAILS SHOULD BE TAKEN FROM OTHER DRAWINGS, THIS IS TO SHOW THE LOCATION OF THE WIRES FROM THE BUSS BAR.
 DETAILS OF THE BOARD/COCKPIT & NAV-ANC SWITCH ARE SHOWN FOR PLACEMENT OF WIRES ONLY.
 JUMPER DETAILS CAN BE FOUND ON CUT SHEETS
 BREAKOUT LENGTHS FOR HRNS AND LEADS SHOULD BE TAKEN FROM FINAL ASSEMBLY PRINTS

FINAL WIRING ASSEMBLY 09-0020

MACHINE & FABRICATION NOTES
 ALL DIMS ARE +/- .010 & ANGLES ARE +/- 1° UNLESS NOTED OTHERWISE
 FINISHED EDGES ARE INDICATED BY FINISH MARK "F"
 PERMETER EDGES ARE TO BE FINISHED, BREAK ALL SHARP EDGES AND CORNERS, PARTS ARE TO BE CLEAR AND FREE OF DEBRIS.

ATLANTIC MARINE PRODUCTS, INC.
 DIRK BY:GM/ML
 CHK BY:GM/ML
 SHEET OF 2
 DATE DRAWN: 08/11/09
 DWG NO. NTS 09-0020
 REVISOR 0

REVISIONS	DATE	APPROVED
1		
2		
3		
4		
5		
6		
7		
8		

8 7 6 5 4 3 2 1 A B C D E F G H

THIS DRAWING IS THE PROPERTY OF ATLANTIC MARINE PRODUCTS, INC. ANY INFORMATION, SPECS OR DESIGNS MAY NOT BE COPIED OR USED IN ANY WAY WITHOUT THE WRITTEN PERMISSION OF ATLANTIC MARINE PRODUCTS, INC. AND IT MUST BE RETURNED UPON REQUEST

REVISIONS		DATE	APPROVED
ZONE/REV	DESCRIPTION		

NAV-ANC SWITCH DETAILS

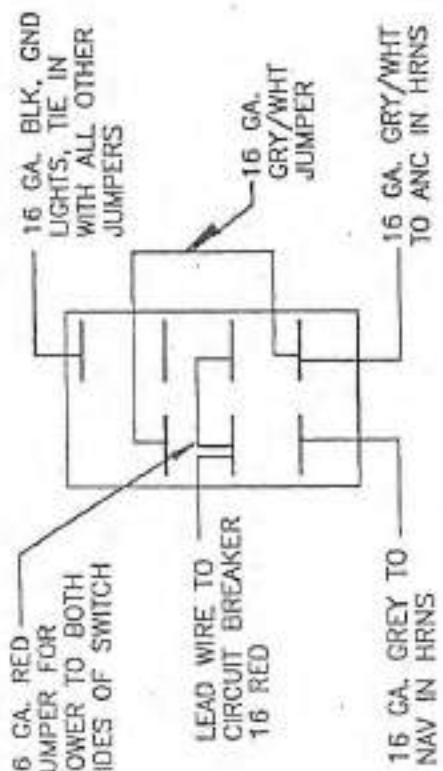

COCKPIT/BOARDING DETAIL

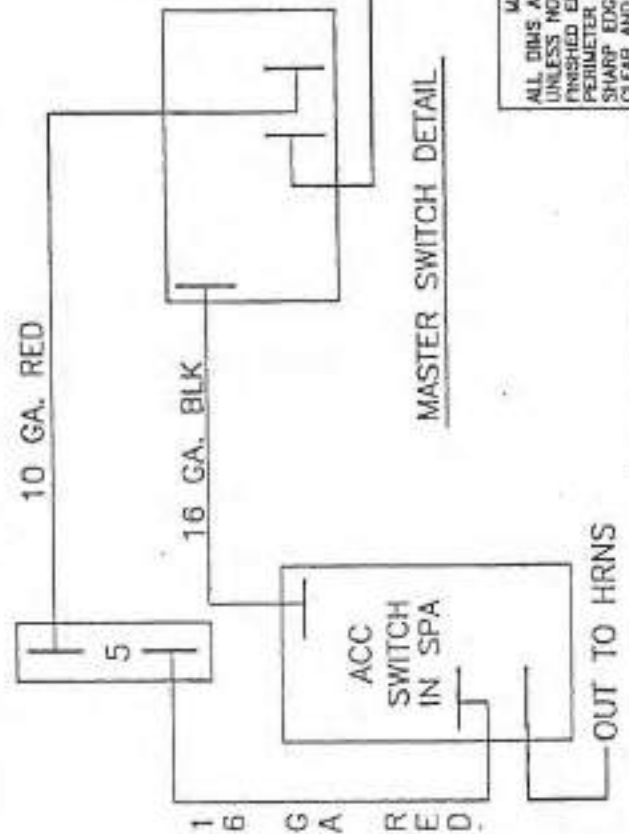
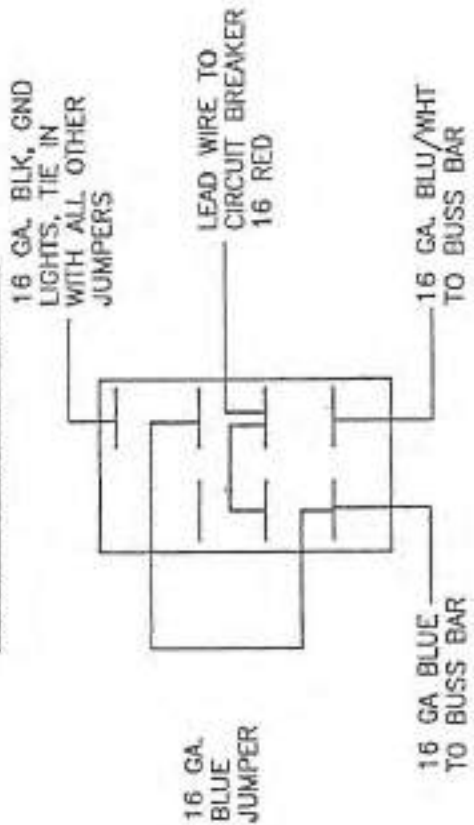

MASTER SWITCH DETAIL

DETAILS OF SWITCH WIRING

MACHINE & FABRICATION NOTES
 ALL DIMS ARE +/- .010 & ANGLES ARE +/- .1" UNLESS NOTED OTHERWISE
 FINISHED EDGES ARE INDICATED BY FINISH MARK "V"
 PERIMETER EDGES ARE TO BE FINISHED. BREAK ALL SHARP EDGES AND CORNERS. PARTS ARE TO BE CLEAR AND FREE OF DEBRIS.

DATE DRAWN: 7 AUG 97
 DWG NO.: NTS 09-0020
 REVISION: 0

ATLANTIC MARINE PRODUCTS, INC.
 DRN BY: DOU WALKER
 ENR BY: GMM
 WORLD CLASS CATAMARAN
 LEISURE CAT

THIS DRAWING IS THE PROPERTY OF ATLANTIC MARINE PRODUCTS, INC. ANY INFORMATION, SPECS OR DESIGNS MAY NOT BE COPIED OR USED IN ANY WAY WITHOUT THE WRITTEN PERMISSION OF ATLANTIC MARINE PRODUCTS, INC. AND IT MUST BE RETURNED UPON REQUEST

ZONE/REV	DESCRIPTION	DATE	APPROVED

16 BRN/RED	○	○	FRESH WATER
16 WHT/RED	○	○	STEREO
16 BRN/BLUE	○	○	STBD FWD BILGE
16 BRN/BLACK	○	○	PORT FWD BILGE
16 BROWN/ORANGE	○	○	AFT STBD BILGE
16 BROWN/YELLOW	○	○	AFT PORT BILGE
16 RED/PURPLE	○	○	ACCESSORY 3
16 RED/WHITE	○	○	ACCESSORY 2
16 RED	○	○	ACCESSORY 1
16 BLUE/WHT	○	○	BOARDING
16 BLUE	○	○	COCKPIT
10 RED	○	○	MASTER POWER
16 GRAY/WHITE	○	○	ANCHOR
16 GRAY	○	○	NAVIGATION

ALL LEAD WIRES ARE FROM SWITCH PANEL ASSEMBLY. SEE WIRING DIAGRAM FOR SWITCH PANEL FOR REF.

SEE CUT SHEET FOR LEAD WIRES FOR LENGTHS AND PROPER TERMINATIONS

BUSS BAR DETAIL FOR LEISURE CAT SWITCH PANEL ASSEMBLY
 PART NUMBER 09-0020

FINAL WIRING ASSEMBLY 09-0020

MACHINE & FABRICATION NOTES
 ALL DIMS ARE +/- .010 & ANGLES ARE +/- 1° UNLESS NOTED OTHERWISE
 FINISHED EDGES ARE INDICATED BY FINISH MARK *
 PERMETER EDGES ARE TO BE FINISHED, BREAK ALL SHARP EDGES AND CORNERS, PARTS ARE TO BE CLEAR AND FREE OF DEBRIS.

ATLANTIC MARINE PRODUCTS, INC
 CHK BY: GMA
 SHEET 1 OF 1 WIRING DETAILS
 DATE DRAWN: 26 SEP 98
 1:1 09-0020

ZONE REV	DESCRIPTION	DATE	APPROVED

REVISIONS	DESCRIPTION	DATE	APPROVED

THIS DRAWING IS THE PROPERTY OF ATLANTIC MARINE PRODUCTS, INC. ANY INFORMATION, SPECS OR DESIGNS MAY NOT BE COPIED OR USED IN ANY WAY WITHOUT THE WRITTEN PERMISSION OF ATLANTIC MARINE PRODUCTS, INC. AND IT MUST BE RETURNED UPON REQUEST

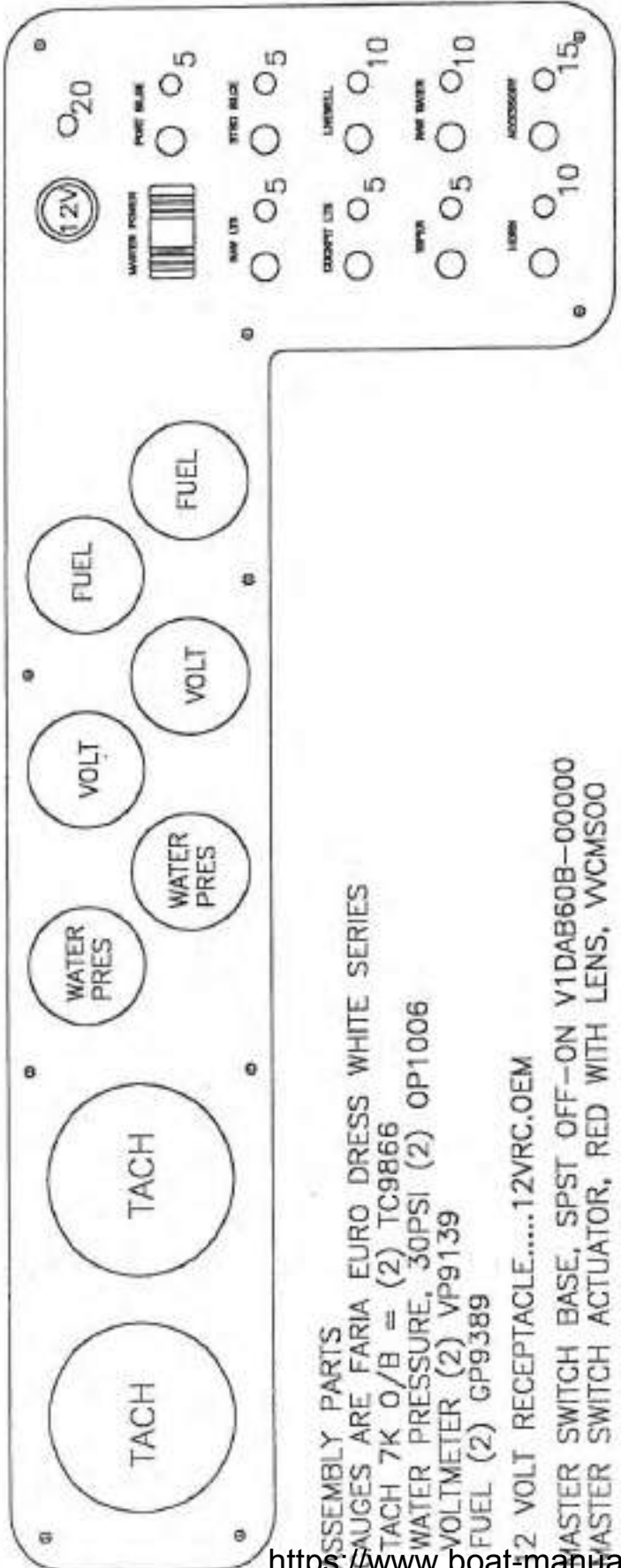

ASSEMBLY PARTS
 GAUGES ARE FARIA EURO DRESS WHITE SERIES

- TACH 7K O/B = (2) TC9866
- WATER PRESSURE, 30PSI (2) OP1006
- VOLTMETER (2) VP9139
- FUEL (2) GP9389

2 VOLT RECEPTACLE.....12VRC.OEM

MASTER SWITCH BASE, SPST OFF-ON V1DAB60B-00000
 MASTER SWITCH ACTUATOR, RED WITH LENS, WCM500

BOGGLERES ARE CARLING CHROME HANDLE STYLE

- NAV-ANG, DPDT ON-OFF-ON, 2GM51-78
- HORN, PUSHBUTTON, RED, 18650
- ALL OTHERS, SPST OFF-ON, 2GA51-78 (7)
- BOOTS FOR SWITCHES, C1131/35-20-BLACK (9)

BREAKERS ARE PUSH TO RESET STYLE

- 5AMP, 1680-217-050-97, (5)
- 10AMP, 1680-217-100-97 (3)
- 15AMP, 1680-217-150-97 (1)
- 20AMP, 1680-217-200-97 (1)

BOOTS FOR CIRCUIT BREAKERS, CLEAR, C1221/24-4-CLEAR(10)
 PANEL, MACHINED AND ENGRAVED, NAF044
 TAPE FOR BACKSIDE OF PANEL, PE1612X1/2

SEE SEPERATE DRAWING FOR WIRING
 DIAGRAM, AND ALSO CUT SHEETS FOR
 WIRE LENGHTS AND TERMINALS

FINAL ASSEMBLY 09-0034

MACHINE & FABRICATION NOTES ALL DIMS ARE +/- .010 & ANGLES ARE +/- 1° UNLESS NOTED OTHERWISE FINISHED EDGES ARE INDICATED BY FINISH MARK "F" PERIMETER EDGES ARE TO BE FINISHED, BREAK ALL SHARP EDGES AND CORNERS, PARTS ARE TO BE CLEAR AND FREE OF DEBRIS.	ATLANTIC MARINE PRODUCTS, INC DIR BY: BYGIM CHK BY: GIM SHEET 1 OF 1 DATE DRAWN: 2-4-2000 SCALE: NTS	WORLD CLASS CATAMARAN 246 DC INST PANEL REV: 09-0034
---	---	--

8	7	6	5	4	3	2	1
THIS DRAWING IS THE PROPERTY OF ATLANTIC MARINE PRODUCTS, INC. ANY INFORMATION, SPECS OR DESIGNS MAY NOT BE COPIED OR USED IN ANY WAY WITHOUT THE WRITTEN PERMISSION OF ATLANTIC MARINE PRODUCTS, INC. AND IT MUST BE RETURNED UPON REQUEST		REVISIONS		DATE	APPROVED		
ZONE (REV)		DESCRIPTION					

NAV/ANC SW. DETAIL

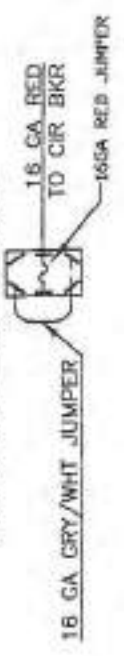

STBD GAUGES

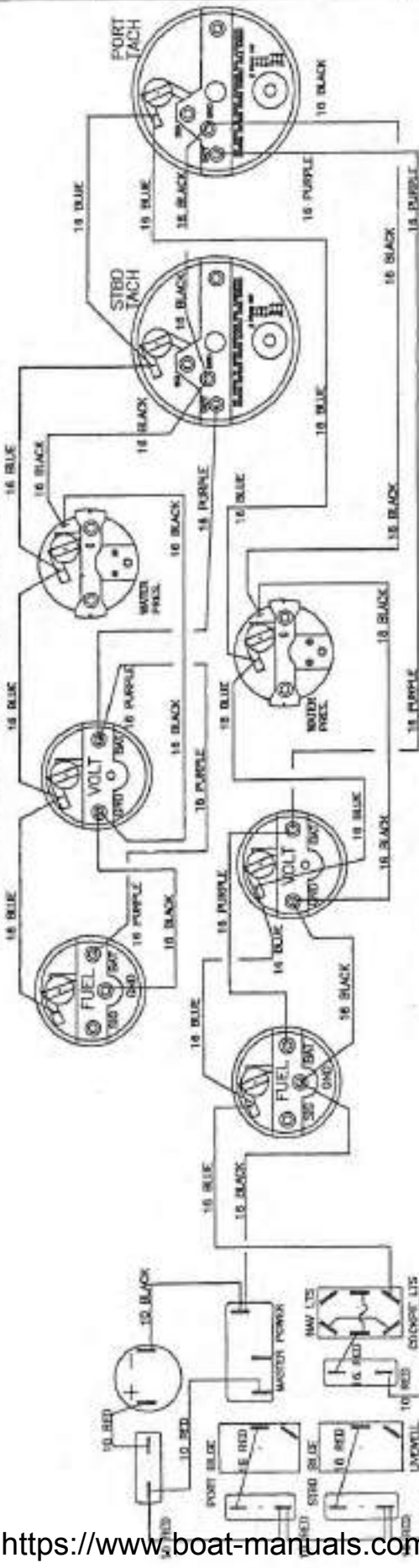

NOTE:
DO NOT CROSS WIRE PORT AND STBD PURPLE WIRES
THEY MUST BE WIRED SEPERATE, BLACK AND BLUE IS COMMON

FINAL WIRING ASSEMBLY 09-0034

MACHINE & FABRICATION NOTES		ATLANTIC MARINE PRODUCTS, INC	
ALL DIMS ARE +/- .010 & ANGLES ARE +/- 1° UNLESS NOTED OTHERWISE		DRAWN BY: GMM/PLM	
FINISHED EDGES ARE INDICATED BY FINISH MARK		WORLD CLASS CATAMARAN	
PERMETER EDGES ARE TO BE FINISHED, BREAK ALL SHARP EDGES AND CORNERS, PARTS ARE TO BE CLEAR AND FREE OF DEBRIS.		DATE: 2-4-2000	
		DRAWN BY: GMM/PLM	
		SHEET 1 OF 2	
		DC INST/SW WIRING	
		DATE DRAWN: 09-0034	
		REVISION	
		0	

A B C D E F G H

ZONE REV	REVISIONS DESCRIPTION	DATE	APPROVED

7 8

THIS DRAWING IS THE PROPERTY OF ATLANTIC MARINE PRODUCTS, INC. ANY INFORMATION, SPECS OR DESIGNS MAY NOT BE COPIED OR USED IN ANY WAY WITHOUT THE WRITTEN PERMISSION OF ATLANTIC MARINE PRODUCTS, INC. AND IT MUST BE RETURNED UPON REQUEST

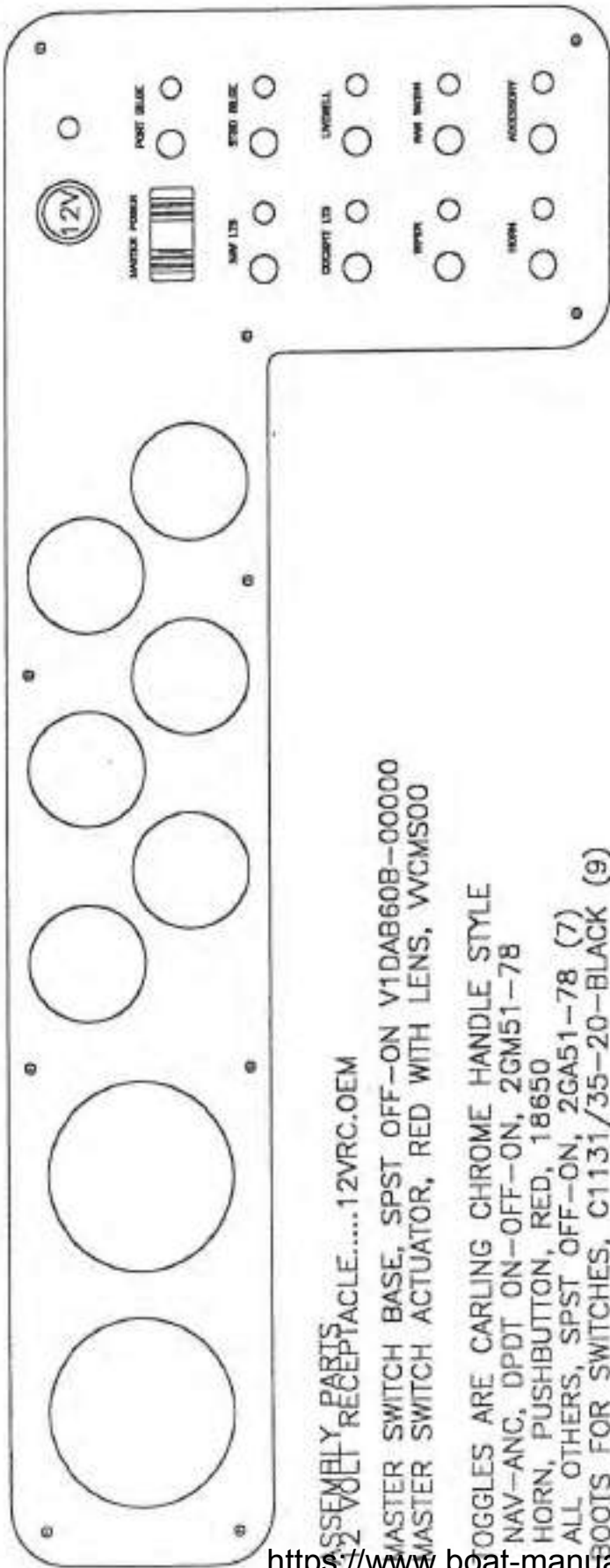

ASSEMBLY PARTS

12 VOLT RECEPTACLE.....12VRC.OEM
 MASTER SWITCH BASE, SPST OFF-ON V1DAB60B-00000
 MASTER SWITCH ACTUATOR, RED WITH LENS, WCM500

TOGGLES ARE CARLING CHROME HANDLE STYLE
 NAV-ANC, DPDT ON-OFF-ON, 2GM51-78
 HORN, PUSHBUTTON, RED, 18650
 ALL OTHERS, SPST OFF-ON, 2GA51-78 (7)
 BOOTTS FOR SWITCHES, C1131/35-20-BLACK (9)

BREAKERS ARE PUSH TO RESET STYLE
 5AMP, 1680-217-050-97, (5)
 10AMP, 1680-217-100-97, (3)
 15AMP, 1680-217-150-97, (1)
 20AMP, 1680-217-200-97, (1)
 BOOTTS FOR CIRCUIT BREAKERS, CLEAR, C1221/24-4-CLEAR(10)
 PANEL, MACHINED AND ENGRAVED, NAF044
 TAPE FOR BACKSIDE OF PANEL, PE1612X1/2

SEE SEPERATE DRAWING FOR WIRING
 DIAGRAM, AND ALSO CUT SHEETS FOR
 WIRE LENGHTS AND TERMINALS
 GAUGES TO BE LOADED BY
 CUSTOMER.

FINAL ASSEMBLY 09-0035

MACHINE & FABRICATION NOTES ALL DIMS ARE +/- .010 & ANGLES ARE +/- 1° UNLESS NOTED OTHERWISE FINISHED EDGES ARE INDICATED BY FINISH MARK ✓ PDRIMETER EDGES ARE TO BE FINISHED, BREAK ALL SHARP EDGES AND CORNERS, PARTS ARE TO BE CLEAR AND FREE OF DEBRIS.	ATLANTIC MARINE PRODUCTS, INC DRN BY:GMW CHK BY:GMW SHEET 1 OF 1 DATE DRAWING: 2-4-2000 REV. NO. 0	WORLD CLASS CATAMARAN DC HONDA INST PMI 2-4-2000 NTS 09-0035
---	---	--

1 2 3 4 5 6 7 8

THIS DRAWING IS THE PROPERTY OF ATLANTIC MARINE PRODUCTS, INC. ANY INFORMATION, SPECS OR DESIGNS MAY NOT BE COPIED OR USED IN ANY WAY WITHOUT THE WRITTEN PERMISSION OF ATLANTIC MARINE PRODUCTS, INC. AND IT MUST BE RETURNED UPON REQUEST

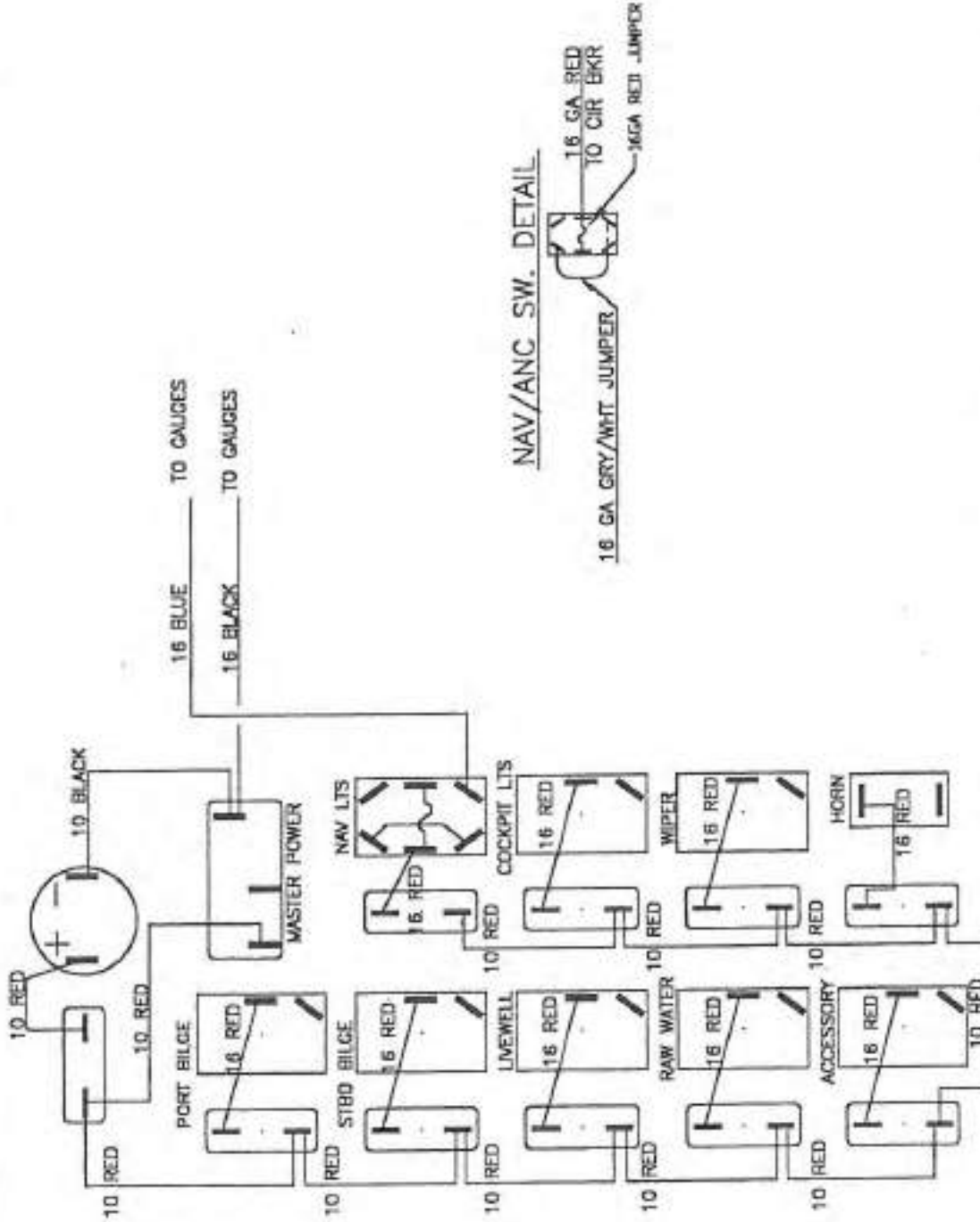

NAV/ANC SW. DETAIL

16 GA. GRY/WHT JUMPER
16 GA. RED TO CIR BKR
16GA RED JUMPER

FINAL WIRING ASSEMBLY 09-0035

MACHINE & FABRICATION NOTES
ALL DIMS ARE +/- .010 & ANGLES ARE +/- 1°
UNLESS NOTED OTHERWISE
FINISHED EDGES ARE INDICATED BY FINISH MARK ✓
PERMETER EDGES ARE TO BE FINISHED, BREAK ALL SHARP EDGES AND CORNERS, PARTS ARE TO BE CLEAR AND FREE OF DEBRIS.

ATLANTIC MARINE PRODUCTS, INC.
DEN BY: [Signature]
CHK BY: GMM WCC 246 DC
SHEET OF 1 HONDA SW WIRING
DATE DRAWN: 2-4-2000
REVISED: NTS 09-0035
REVISED: 0

ZONE/REV	REVISIONS DESCRIPTION	DATE	APPROVED

1 2 3 4 5 6 7 8 A B C D E F G H

A B C D E F G H

REVISIONS		DATE	APPROVED
ZONE/REV	DESCRIPTION		

THIS DRAWING IS THE PROPERTY OF ATLANTIC MARINE PRODUCTS, INC. ANY INFORMATION, SPECS OR DESIGNS MAY NOT BE COPIED OR USED IN ANY WAY WITHOUT THE WRITTEN PERMISSION OF ATLANTIC MARINE PRODUCTS, INC. AND IT MUST BE RETURNED UPON REQUEST

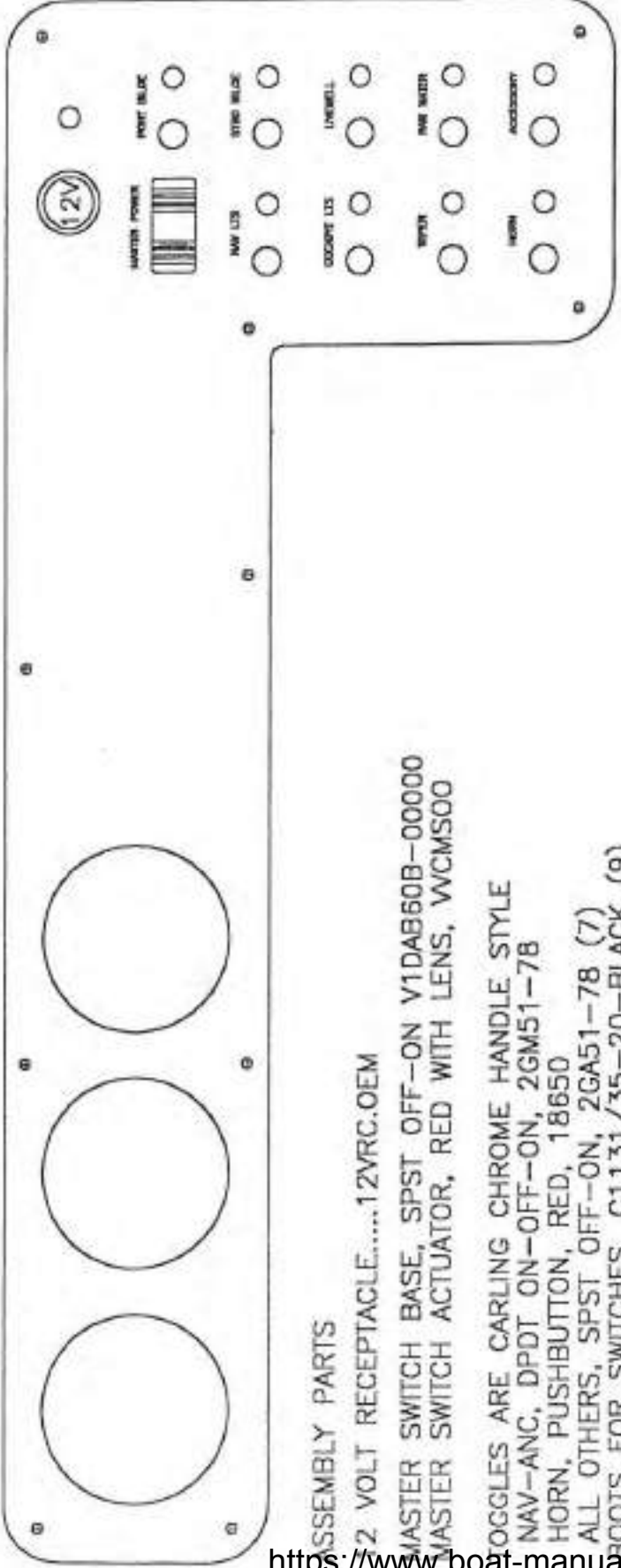

ASSEMBLY PARTS

2 VOLT RECEPTACLE.....12VRC.OEM

MASTER SWITCH BASE, SPST OFF-ON V1DAB60B-00000

MASTER SWITCH ACTUATOR, RED WITH LENS, WCM500

GOOGLES ARE CARLING CHROME HANDLE STYLE

NAV-ANC, DPDT ON-OFF-ON, 2GM51-7B

HORN, PUSHBUTTON, RED, 18650

ALL OTHERS, SPST OFF-ON, 2GA51-78 (7)

BOOTS FOR SWITCHES, C1131/35-20-BLACK (9)

BREAKERS ARE PUSH TO RESET STYLE

5AMP, 1680-217-050-97, (5)

10AMP, 1680-217-100-97, (3)

15AMP, 1680-217-150-97, (1)

20AMP, 1680-217-200-97, (1)

BOOTS FOR CIRCUIT BREAKERS, CLEAR, C1221/24-4-CLEAR(10)

PANEL, MACHINED AND ENGRAVED, NAF045

TAPE FOR BACKSIDE OF PANEL, PE1612X1/2

SEE SEPERATE DRAWING FOR WIRING DIAGRAM, AND ALSO CUT SHEETS FOR WIRE LENGHTS AND TERMINALS

FINAL ASSEMBLY 09-0036

MACHINE & FABRICATION NOTES
 ALL DIMS ARE +/- .010 & ANGLES ARE +/- .1° UNLESS NOTED OTHERWISE
 FINISHED EDGES ARE INDICATED BY FINISH MARK "F"
 FORMER EDGES ARE TO BE FINISHED. BREAK ALL SHARP EDGES AND CORNERS. PARTS ARE TO BE CLEAR AND FREE OF DEBRIS.

ATLANTIC MARINE PRODUCTS, INC
 DESIGNED BY: [unclear]
 CHK BY: [unclear] WCC 246 DC
 SHEET 1 OF 1 YAMAHA INST/SW PANEL
 DATE DRAWN: [unclear] DWG NO. [unclear]
 P-4-2000 NTS 09-0036 REVISION 0

8 7 6 5 4 3 2 1

A	B	C	D	E	F	G	H
---	---	---	---	---	---	---	---

REVISIONS	DESCRIPTION	DATE	APPROVED
1			
2			
3			
4			
5			
6			
7			
8			

ASSEMBLY PARTS

GAUGES ARE FARIA CHESAPEAKE WHITE SS SERIES
 TACH 7K = TC9863/XI01900 (2 REQ'D)
 VOLTMETER = VP9158/XY02400 (2 REQ'D)
 FUEL = GP9373/XY02400 (2 REQ'D)
 WATER PRES. 30PSI = OP1022/XU03600 (2 REQ'D)

12 VOLT RECEPTACLE.....12VRC.OEM
 MASTER SWITCH BASE, SPST OFF-ON V1DAB60B-00000
 MASTER SWITCH ACTUATOR, RED WITH LENS, WCM500
 MASTER POWER SCREENED ON ACTUATOR

TOGGLES ARE CARLING CHROME HANDLE STYLE
 NAV-ANC, DPDT ON-OFF-ON, 2GM51-78
 HORN, PUSHBUTTON, RED, 18650
 ALL OTHERS, SPST OFF-ON, 2GA51-78 (8)
 BOOTS FOR SWITCHES, C1131/35-20-BLACK (9)

BREAKERS ARE PUSH TO RESET STYLE
 5AMP, 1680-217-050-97, (4)
 10AMP, 1680-217-100-97 (3)
 15AMP, 1680-217-150-97 (3)
 BOOTS FOR CIRCUIT BREAKERS, CLEAR
 C1221/24-4-CLEAR (10)

PANEL, MACHINED AND ENGRAVED, NAF049
 3/16 CARBON FIBER ON WHITE ABS
 TAPE FOR BACKSIDE OF PANEL, PE1612X1/2

226 CC STANDARD ASSEMBLY 09-0043

MACHINE & FABRICATION NOTES	ATLANTIC MARINE PRODUCTS, INC
ALL DIMS ARE +/- .010 & ANGLES ARE +/- 1° UNLESS NOTED OTHERWISE	DRN BY: GML
FINISHED EDGES ARE INDICATED BY FINISH MARK	WORLD CLASS CATAMARAN
PERIMETER EDGES ARE TO BE FINISHED. BREAK ALL SHARP EDGES AND CORNERS. PARTS ARE TO BE CLEAR AND FREE OF DEBRIS.	SHEET OF X 226 CC STANDARD 2001
	DATE DRAWN: 18 JULY 00
	REVISED: NTS 09-0043
	0

THIS DRAWING IS THE PROPERTY OF ATLANTIC MARINE PRODUCTS, INC. INFORMATION, SPECS OR DESIGNS MAY NOT BE COPIED OR USED IN ANY WAY WITHOUT THE WRITTEN PERMISSION OF ATLANTIC MARINE PRODUCTS, INC. AND IT MUST BE RETURNED UPON REQUEST

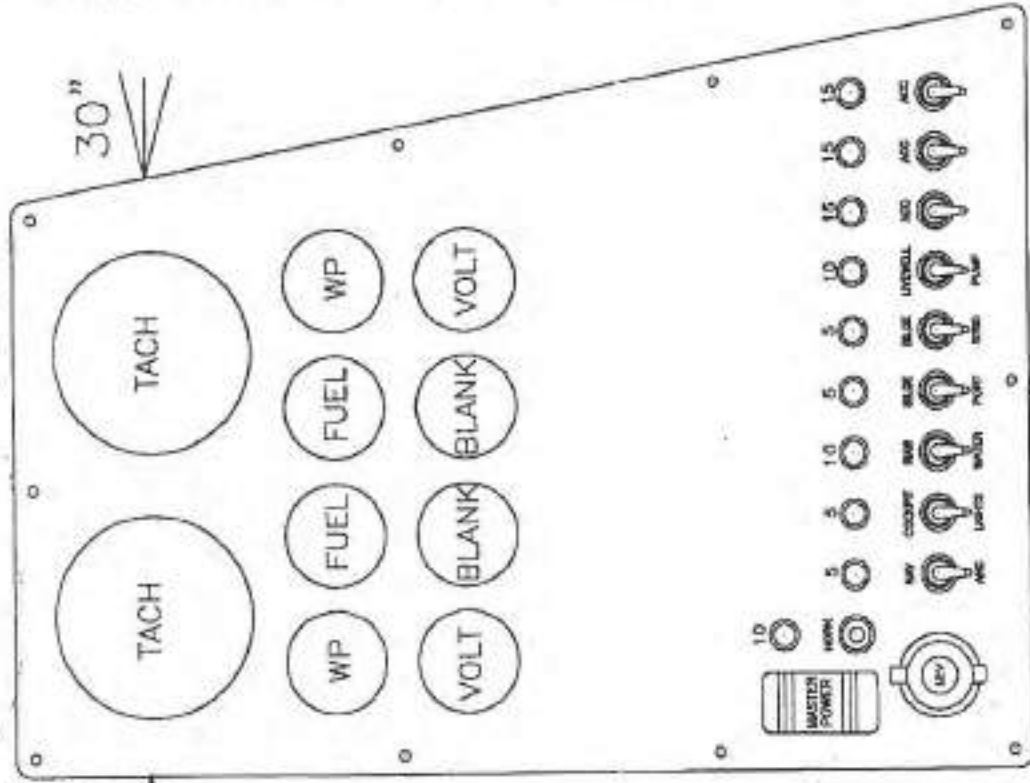

ALL LEAD WIRES BREAK OUT AT BOTTOM OF PANEL, SEE WIRING DIAGRAM

SEE SEPERATE DRAWING FOR WIRING AND CUTSHEETS FOR WIRE LENGTH

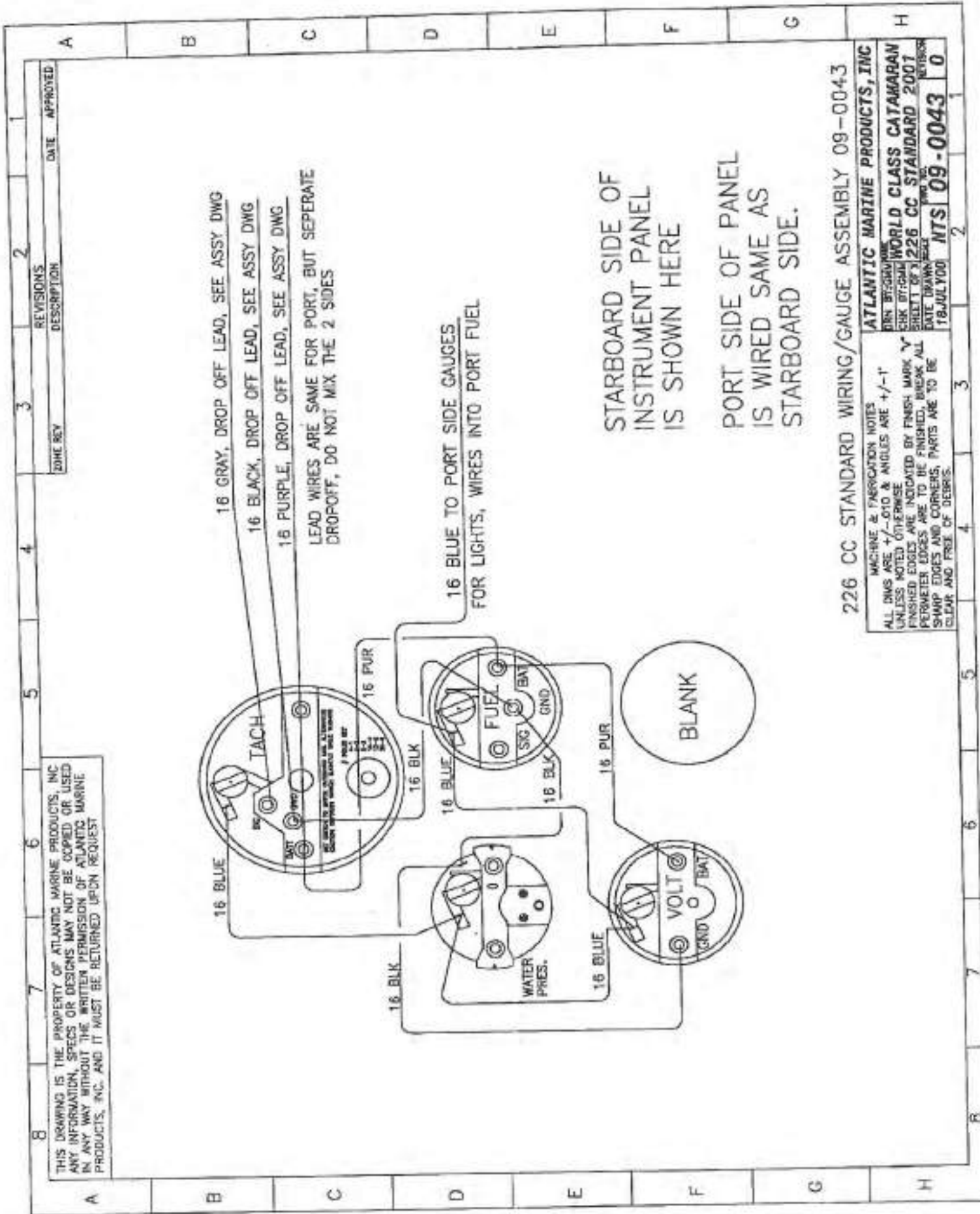

226 CC STANDARD WIRING/GAUGE ASSEMBLY 09-0043

MACHINE & FABRICATION NOTES
 ALL DWGS ARE +/- .010 & ANGLES ARE +/- 1°
 UNLESS NOTED OTHERWISE
 FINISHED EDGES ARE INDICATED BY FINISH MARK ✓
 PERMETER EDGES ARE TO BE FINISHED, BREAK ALL SHARP EDGES AND CORNERS, PARTS ARE TO BE CLEAR AND FREE OF DEBRIS.

ATLANTIC MARINE PRODUCTS, INC.
 DRN DESIGN
 CHK BY: GJM
 226 CC STANDARD 2007
 DATE DRAWN: 18-JULY-00
 NTS 09-0043 0

THIS DRAWING IS THE PROPERTY OF ATLANTIC MARINE PRODUCTS, INC. ANY INFORMATION, SPECS OR DESIGNS MAY NOT BE COPIED OR USED IN ANY WAY WITHOUT THE WRITTEN PERMISSION OF ATLANTIC MARINE PRODUCTS, INC. AND IT MUST BE RETURNED UPON REQUEST

DATE REV	DESCRIPTION	DATE	APPROVED
2			

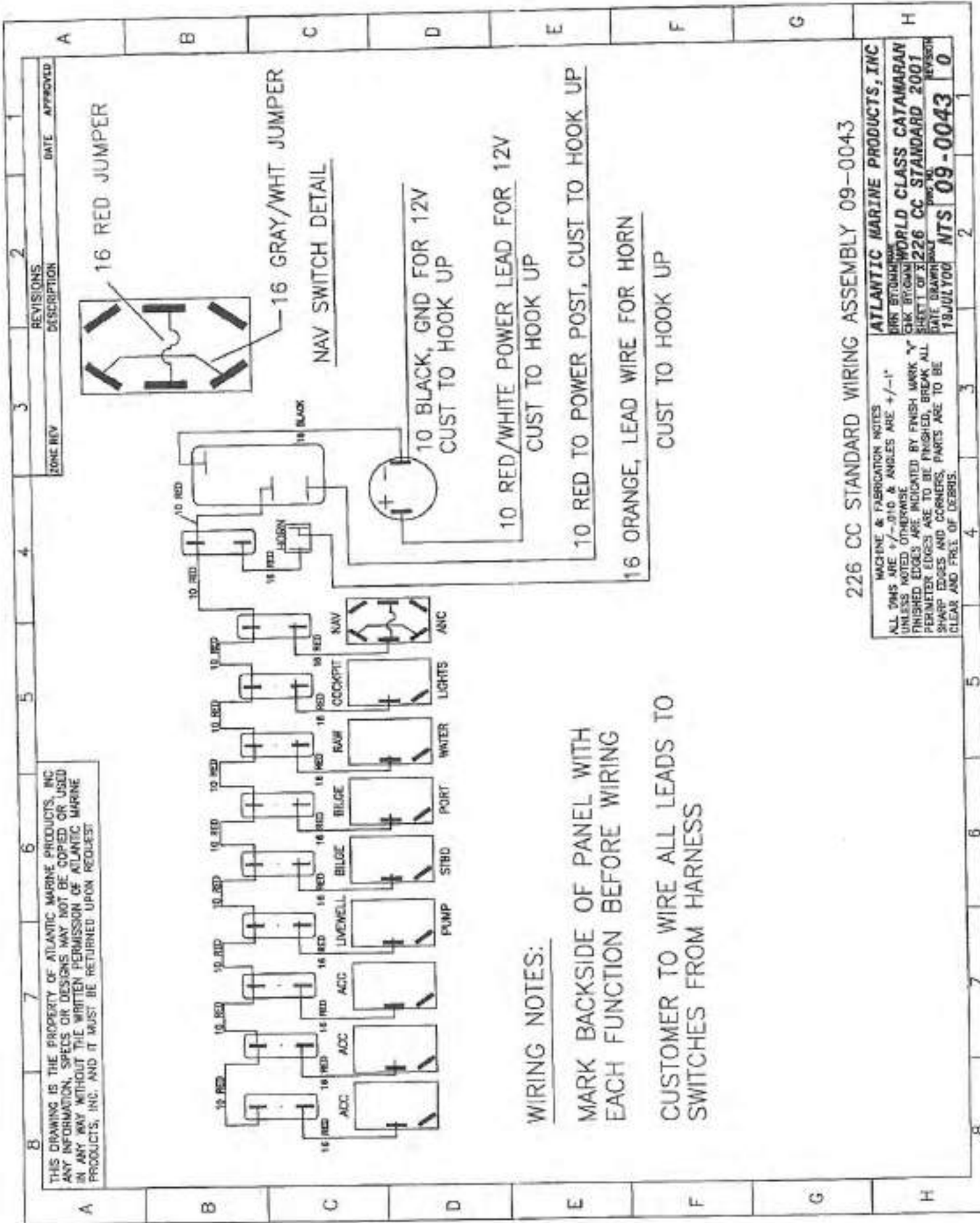

THIS DRAWING IS THE PROPERTY OF ATLANTIC MARINE PRODUCTS, INC. ANY INFORMATION, SPECS OR DESIGNS MAY NOT BE COPIED OR USED IN ANY WAY WITHOUT THE WRITTEN PERMISSION OF ATLANTIC MARINE PRODUCTS, INC. AND IT MUST BE RETURNED UPON REQUEST.

ZONE REV	REVISIONS DESCRIPTION	DATE	APPROVED

WIRING NOTES:

MARK BACKSIDE OF PANEL WITH EACH FUNCTION BEFORE WIRING
 CUSTOMER TO WIRE ALL LEADS TO SWITCHES FROM HARNESS

10 BLACK, GND FOR 12V
 CUST TO HOOK UP

10 RED/WHITE POWER LEAD FOR 12V
 CUST TO HOOK UP

10 RED TO POWER POST, CUST TO HOOK UP

16 ORANGE, LEAD WIRE FOR HORN
 CUST TO HOOK UP

226 CC STANDARD WIRING ASSEMBLY 09-0043

MACHINE & FABRICATION NOTES
 ALL DIMS ARE +/- .010 & ANGLES ARE +/- .1"
 UNLESS NOTED OTHERWISE
 FINISHED EDGES ARE INDICATED BY FINISH MARK "Y"
 PERMETER EDGES ARE TO BE FINISHED, BREAK ALL SHARP EDGES AND CORNERS. PARTS ARE TO BE CLEAR AND FREE OF DEBRIS.

ATLANTIC MARINE PRODUCTS, INC.
 DRN BT00000000
 CLK BT00000000
 WORLD CLASS CATAMARAN
 SHEET 1 OF 3
 DATE DRAWN 04/19/00
 DESIGNED BY
 19JULY00 NTS 09-0043 0

A	B	C	D	E	F	G	H
---	---	---	---	---	---	---	---

ZONE REV	DESCRIPTION	DATE	APPROVED

ASSEMBLY PARTS

- 12 VOLT RECEPTACLE.....12VRC.OEM
- MASTER SWITCH BASE, SPST OFF-ON V1DAB60B-00000
- MASTER SWITCH ACTUATOR, RED WITH LENS, WCM500
- MASTER POWER SCREENED ON ACTUATOR
- TOGGLES ARE CARLING CHROME HANDLE STYLE
- NAV-ANC, DPDT ON-OFF-ON, 2GM51-78
- HORN, PUSHBUTTON, RED, 18650
- ALL OTHERS, SPST OFF-ON, 2GA51-78 (8)
- BOOTS FOR SWITCHES, C1131/35-20-BLACK (9)
- BREAKERS ARE PUSH TO RESET STYLE
- 5AMP, 1680-217-050-97, (4)
- 10AMP, 1680-217-100-97 (3)
- 15AMP, 1680-217-150-97 (3)
- BOOTS FOR CIRCUIT BREAKERS, CLEAR
- C1221/24-4-CLEAR (10)
- PANEL, MACHINED AND ENGRAVED, NAFO49
- 3/16 CARBON FIBER ON WHITE ABS
- TAPE FOR BACKSIDE OF PANEL, PE1612X1/2

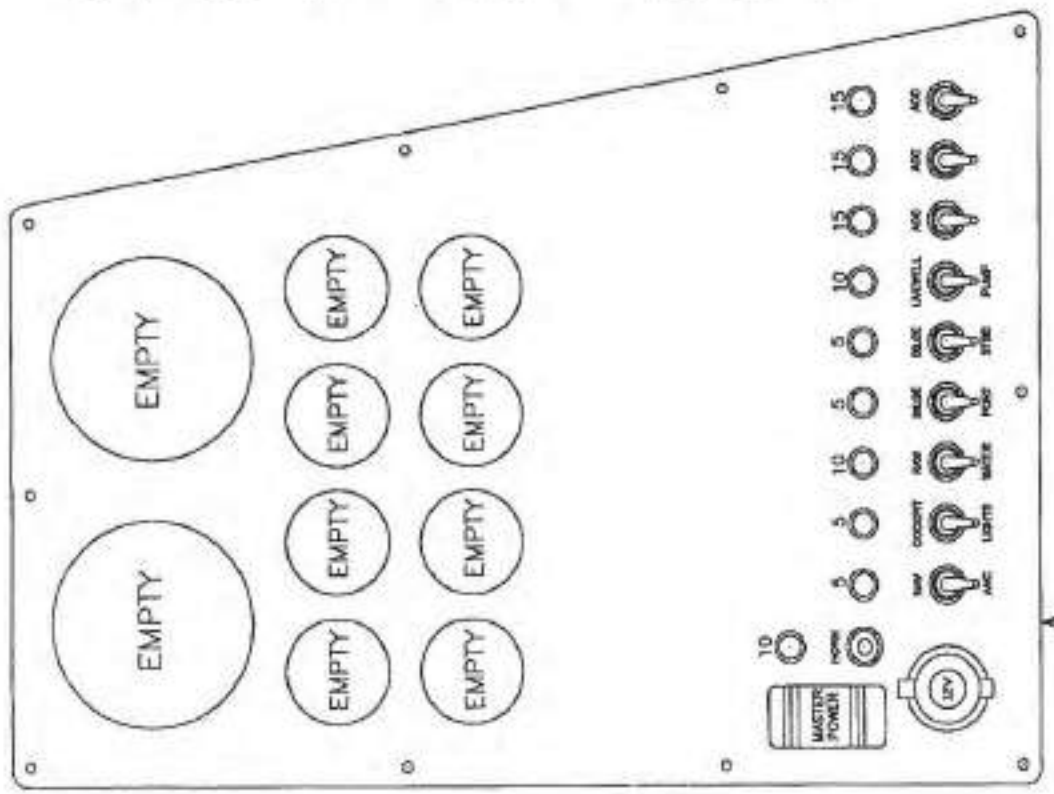

ALL LEAD WIRES BREAK OUT AT BOTTOM OF PANEL, SEE WIRING DIAGRAM

SEE SEPERATE DRAWING FOR WIRING AND CUTSHEETS FOR WIRE LENGTH

226 CC HONDA ASSEMBLY 09-0045

MACHINE & FABRICATION NOTES	
ALL DIMS ARE +/- .010 & ANGLES ARE +/- 1°	UNLESS NOTED OTHERWISE
FINISHED EDGES ARE INDICATED BY FINISH MARK	PERIMETER EDGES ARE TO BE FINISHED, BREAK ALL
SHARP EDGES AND CORNERS, PARTS ARE TO BE	CLEAR AND FREE OF DEBRIS.
DATE DRAWN	DATE APPROVED
18JULY00	18JULY00
DRN BY: JMM	CHK BY: JMM
WORLD CLASS CATAMARAN	SHEET 1 OF 2
226 CC HONDA 2007	REV. NO.
NTS	09-0045
0	0

ATLANTIC MARINE PRODUCTS, INC

THIS DRAWING IS THE PROPERTY OF ATLANTIC MARINE PRODUCTS, INC. ANY INFORMATION, SPECS OR DESIGNS MAY NOT BE COPIED OR USED IN ANY WAY WITHOUT THE WRITTEN PERMISSION OF ATLANTIC MARINE PRODUCTS, INC. AND IT MUST BE RETURNED UPON REQUEST

DATE	APPROVED

REV	DESCRIPTION

ZDHE REV

2

3

4

5

6

7

8

THIS DRAWING IS THE PROPERTY OF ATLANTIC MARINE PRODUCTS, INC. ANY INFORMATION, SPECS OR DESIGNS MAY NOT BE COPIED OR USED IN ANY WAY WITHOUT THE WRITTEN PERMISSION OF ATLANTIC MARINE PRODUCTS, INC. AND IT MUST BE RETURNED UPON REQUEST

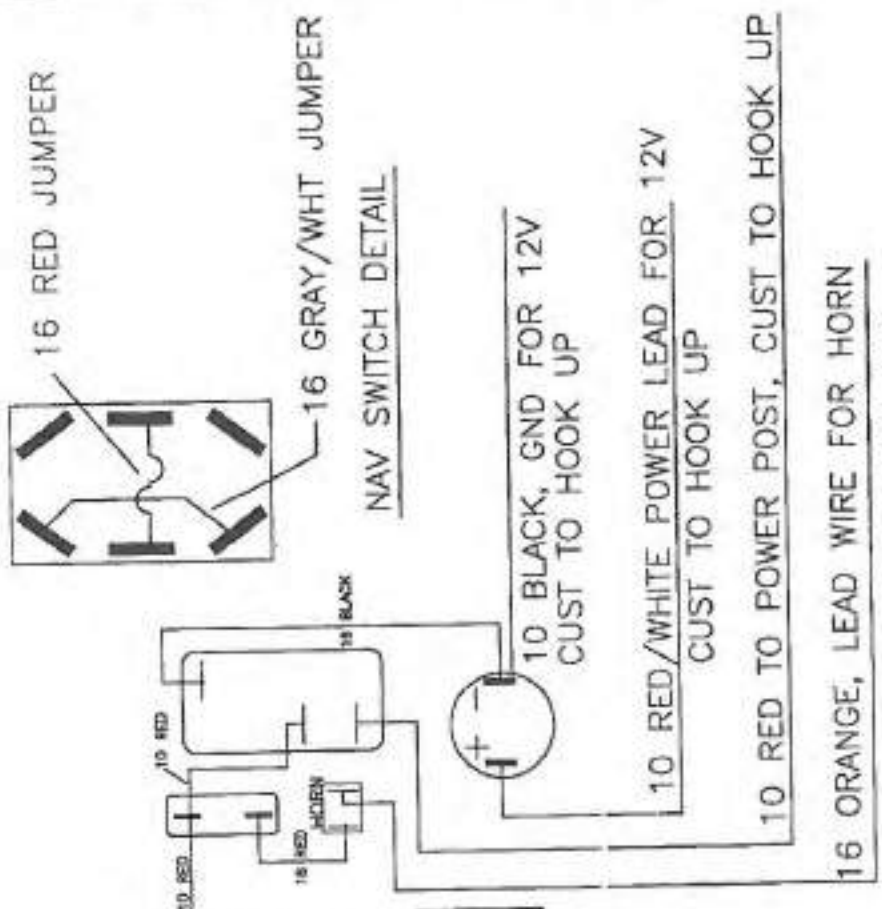

226 CC HONDA WIRING ASSEMBLY 09-0045

WIRING NOTES:

MARK BACKSIDE OF PANEL WITH EACH FUNCTION BEFORE WIRING
 CUSTOMER TO WIRE ALL LEADS TO SWITCHES FROM HARNESS

MACHINE & FABRICATION NOTES
 ALL DIMS ARE +/- .010 & ANGLES ARE +/- .1° UNLESS NOTED OTHERWISE
 FINISHED EDGES ARE INDICATED BY FINISH MARK "V"
 PERIMETER EDGES ARE TO BE FINISHED, BREAK ALL SHARP EDGES AND CORNERS, PARTS ARE TO BE CLEAR AND FREE OF DEBRIS.

ATLANTIC MARINE PRODUCTS, INC
 DRN BY: CHUM
 CHK BY: GWAN
 SHEET OF 4
 DATE DRAWING: 1/18/00
 DIMS: CC
 WORLD CLASS CATAMARAN
 226 CC HONDA 2001
 NTS 09-0045
 REVISION 0

A	B	C	D	E	F	G																															
<p>NO GAUGES ARE LOADED, CUSTOMER TO LOAD GAUGES SEE SEPERATE DRAWING FOR WIRING AND CUTSHEETS FOR WIRE LENGTH</p>													<p>REVISIONS DESCRIPTION DATE APPROVED</p>					<p>ZONE REV</p>			<p>1</p>		<p>2</p>		<p>3</p>		<p>4</p>										
<p>ASSEMBLY PARTS</p> <p>12 VOLT RECEPTACLE.....12VRC.OEM</p> <p>MASTER SWITCH BASE, SPST OFF-ON V1DAB60B-00000</p> <p>MASTER SWITCH ACTUATOR, RED WITH LENS, WCM500</p> <p>MASTER POWER SCREENED ON ACTUATOR</p> <p>TOGGLES ARE CARLING CHROME HANDLE STYLE</p> <p>NAV-ANG, DPDT ON-OFF-ON, 2GM51-78</p> <p>HORN, PUSHBUTTON, RED, 18650</p> <p>ALL OTHERS, SPST OFF-ON, 2GA51-78 (8)</p> <p>BOOTS FOR SWITCHES, C1131/35-20-BLACK (9)</p> <p>BREAKERS ARE PUSH TO RESET STYLE</p> <p>5AMP, 1680-217-050-97, (4)</p> <p>10AMP, 1680-217-100-97 (3)</p> <p>15AMP, 1680-217-150-97 (3)</p> <p>BOOTS FOR CIRCUIT BREAKERS, CLEAR</p> <p>C1221/24-4-CLEAR (10)</p> <p>PANEL, MACHINED AND ENGRAVED, NAF050</p> <p>3/16 CARBON FIBER ON WHITE ABS</p> <p>TAPE FOR BACKSIDE OF PANEL, PE1612X1/2</p> <p>1/2 HOLE PLUG, 2643, 1 REQ'D</p>																																					
<p>MACHINE & FABRICATION NOTES</p> <p>ALL DIMS ARE +/- .010 & ANGLES ARE +/- 1° UNLESS NOTED OTHERWISE</p> <p>FINISHED EDGES ARE INDICATED BY FINISH MARK ~</p> <p>PERMETER EDGES ARE TO BE FINISHED. BREAK ALL SHARP EDGES AND CORNERS. PARTS ARE TO BE CLEAR AND FREE OF DEBRIS.</p>																		<p>ATLANTIC MARINE PRODUCTS, INC DRW BY: GMMARK</p> <p>WORLD CLASS CATERANAN SHEET 1 OF 1, 226 CC YAMAHA/MERC 2007H DATE DRAWING: NTS 09-0044 REV: 0 16 JULY 00</p>					<p>226 CC YAMAHA/MERC ASSEMBLY 09-0044</p>			<p>5</p>		<p>6</p>		<p>7</p>		<p>8</p>		<p>9</p>		<p>10</p>	

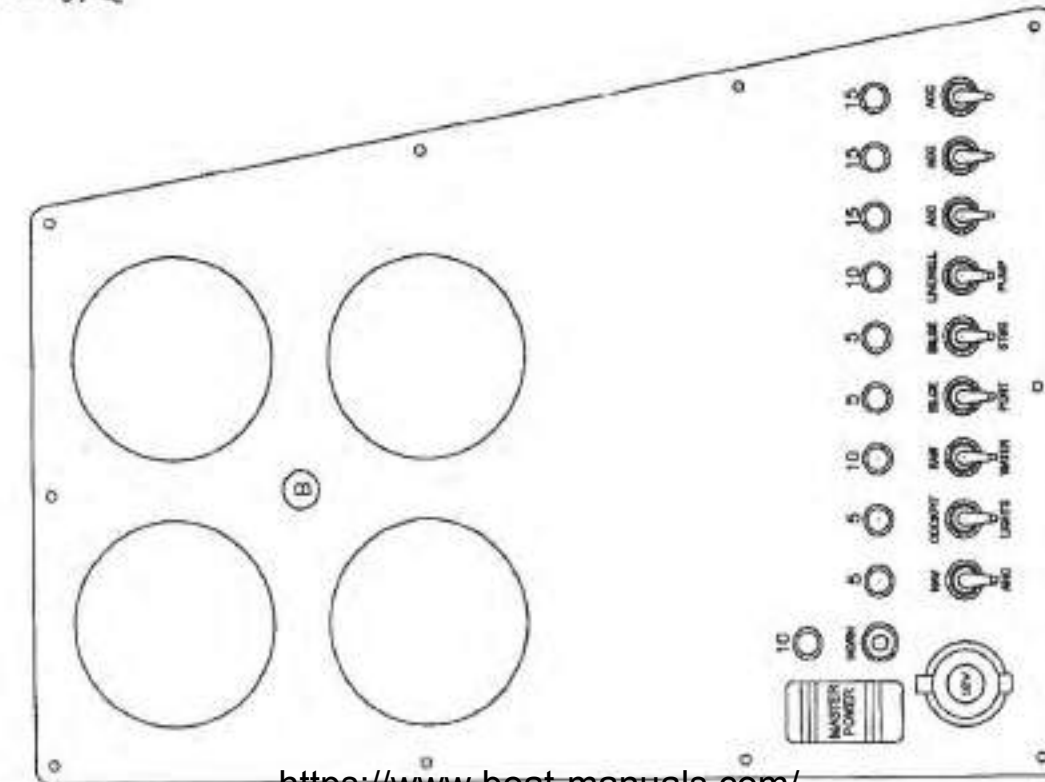

ALL LEAD WIRES BREAK OUT AT BOTTOM OF PANEL, SEE WIRING DIAGRAM

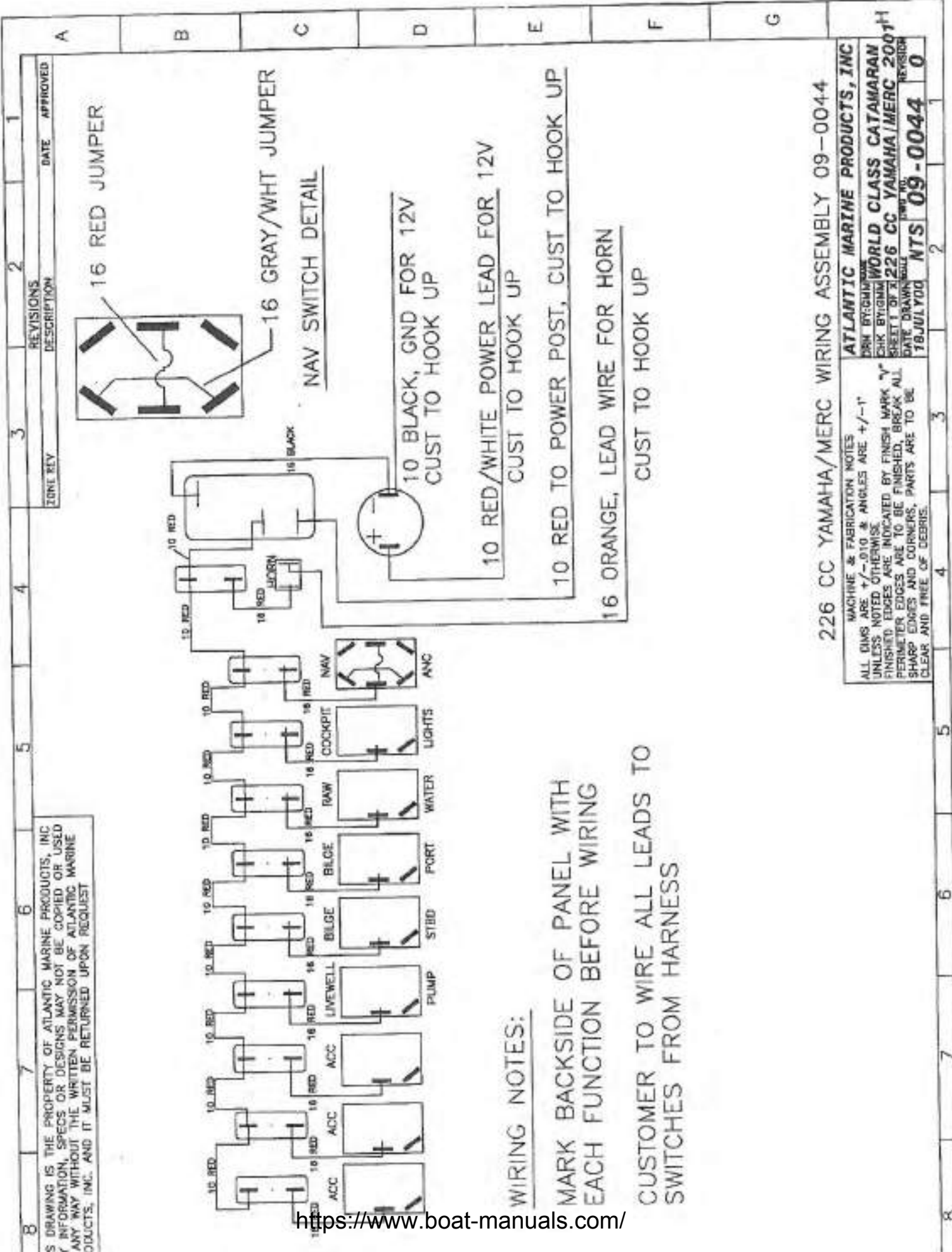

16 RED JUMPER

16 GRAY/WHT JUMPER

NAV SWITCH DETAIL

10 BLACK, GND FOR 12V
CUST TO HOOK UP

10 RED/WHITE POWER LEAD FOR 12V
CUST TO HOOK UP

10 RED TO POWER POST, CUST TO HOOK UP

16 ORANGE, LEAD WIRE FOR HORN
CUST TO HOOK UP

226 CC YAMAHA/MERC WIRING ASSEMBLY 09-0044

ATLANTIC MARINE PRODUCTS, INC
 CHK BY: []
 WORLD CLASS CATALANAN
 SHEET 1 OF 3
 DATE DRAWN: []
 18 JULY 00 NTS 09-0044

MACHINE & FABRICATION NOTES
 ALL DIMS ARE +/- .010 & ANGLES ARE +/- 1°
 UNLESS NOTED OTHERWISE
 FINISHED EDGES ARE INDICATED BY FINISH MARK "V"
 PERIMETER EDGES ARE TO BE FINISHED, BREAK ALL
 SHARP EDGES AND CORNERS, PARTS ARE TO BE
 CLEAR AND FREE OF DEBRIS.

WIRING NOTES:

MARK BACKSIDE OF PANEL WITH EACH FUNCTION BEFORE WIRING

CUSTOMER TO WIRE ALL LEADS TO SWITCHES FROM HARNESS

THIS DRAWING IS THE PROPERTY OF ATLANTIC MARINE PRODUCTS, INC. ANY INFORMATION, SPECS OR DESIGNS MAY NOT BE COPIED OR USED ANY WAY WITHOUT THE WRITTEN PERMISSION OF ATLANTIC MARINE PRODUCTS, INC. AND IT MUST BE RETURNED UPON REQUEST

A B C D E F G H

ZONE REV	DESCRIPTION	DATE	APPROVED

REVISIONS	DESCRIPTION	DATE	APPROVED

THIS DRAWING IS THE PROPERTY OF ATLANTIC MARINE PRODUCTS, INC. ANY INFORMATION, SPECS OR DESIGNS MAY NOT BE COPIED OR USED IN ANY WAY WITHOUT THE WRITTEN PERMISSION OF ATLANTIC MARINE PRODUCTS, INC. AND IT MUST BE RETURNED UPON REQUEST

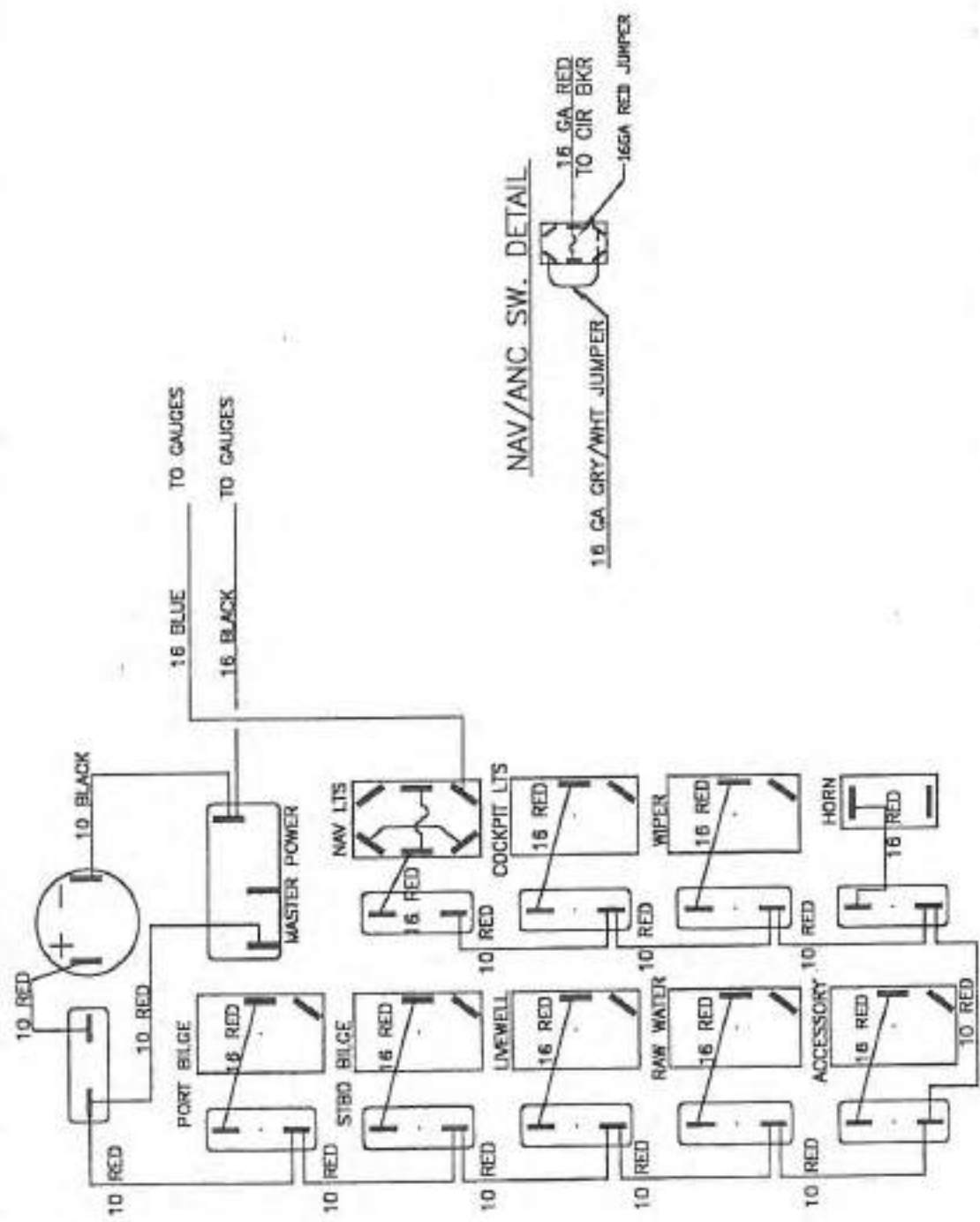

NAV/ANC SW. DETAIL

16 GA. GRY/WHT JUMPER
 16 GA. RED TO CIR BKR
 16GA RED JUMPER

FINAL WIRING ASSEMBLY 09-0036

MACHINE & FABRICATION NOTES
 ALL DIMS ARE +/- .010 & ANGLES ARE +/- 1°
 UNLESS NOTED OTHERWISE
 FINISHED EDGES ARE INDICATED BY FINISH MARK ✓
 PERMETER EDGES ARE TO BE FINISHED, BREAK ALL SHARP EDGES AND CORNERS, PARTS ARE TO BE CLEAR AND FREE OF DEBRIS.

ATLANTIC MARINE PRODUCTS, INC	
CHK BY: GJM	WCC 246 DC
DATE DRAWN: 2-4-2000	YAMAHA SW WIRING
REVISED: NTS	FIG. NO. 09-0036

FEB 25 2001

ASSEMBLY PARTS

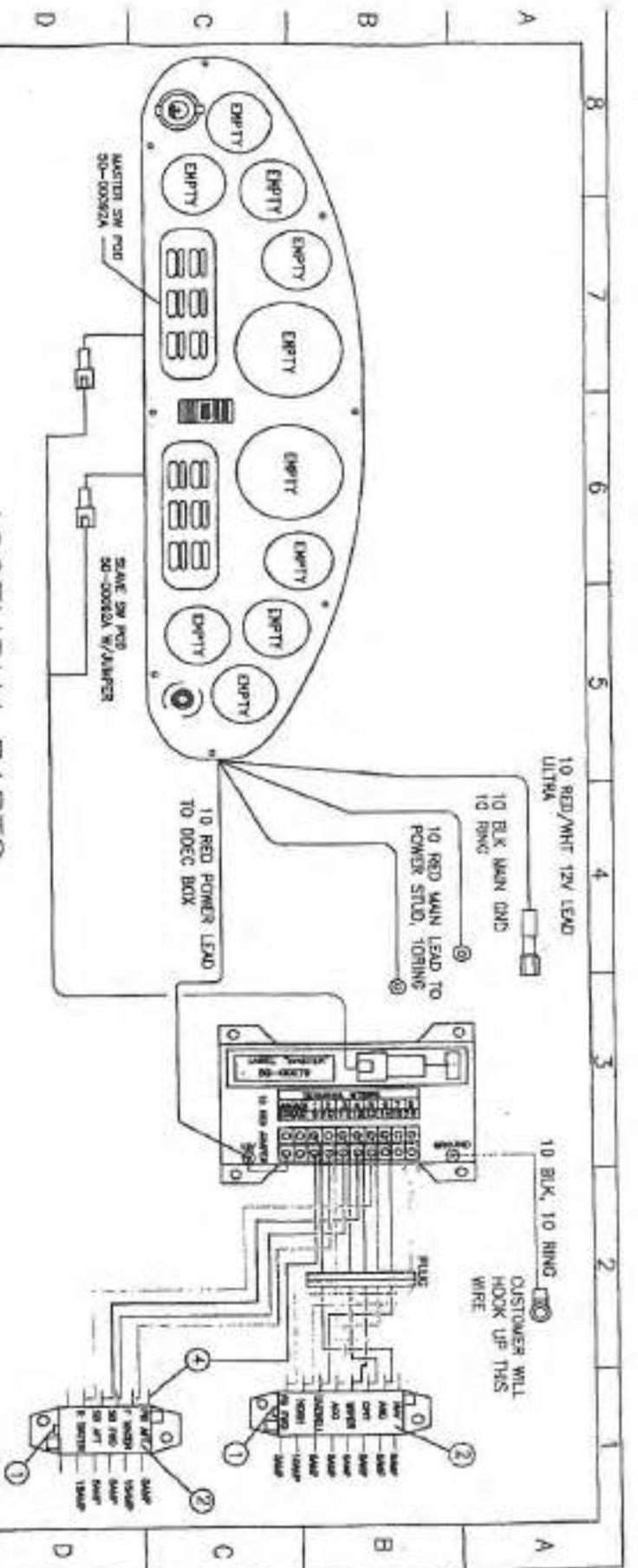

PANEL, 130 BURL D-TECHNIQUE, NAF047, (1 REQ'D)
 CARLING CONTURA II, ROCKER, LT AND ACTUATOR:
 BASE SPST OFF-ON, LT VIDAB09-00000-000
 ACTUATOR, HARD RED 1 LENS, WCMXSD WITH
 MASTER POWER SCREENED ON IT.
 DIMMER, ROTARY SWITCH-#6400-7055, (1 REQ'D)
 KNOB FOR DIMMER SWITCH, KNSS01-1/4, (1 REQ'D)
 12 VOLT POWER POINT, MARINCO, 12VRC.0EM

FUSEBLOCKS: HELLA WATER TIGHT STYLE:
 8 WAY WITH COVER, 62940, 1 PER ASSEMBLY
 4 WAY WITH COVER, 62936, 1 PER ASSEMBLY
 FUSES ARE ATC AUTO STYLE IGNITION PROTECTED:
 5AMP, ATC5, 9 PER ASSEMBLY
 10AMP, ATC10, 1 PER ASSEMBLY
 15AMP, ATC15, 1 PER ASSEMBLY
 FUSEBLOCK LABEL, CENCONBDECALWCC, 1 PER ASSEMBLY
 FUSEBLOCK LABEL, CENCONWDECALWCC, 1 PER ASSEMBLY

ELECTRONIC SWITCHING SYSTEM:
 KIT WILL HAVE 1 OF EVERYTHING UNLESS NOTED:
 LEFT SWITCH POD W/BLK BEZEL, 50-00092A MASTER PANEL
 RIGHT SWITCH POD W/BLK BEZEL, 50-00092A W/JUMPER SLAVE PANEL
 9 WAY DDEC, 50-00090A, MASTER RELAY BOX
 DATA COW * CABLE, 8 X 72 X 8

ASSEMBLY LAYOUT FOR 09-0039

MACHINE # FABRICATION NOTES ALL DIMS ARE +/- .010 & ANGLES ARE +/- ° UNLESS NOTED OTHERWISE

THIS DRAWING IS THE PROPERTY OF ATLANTIC MARINE PRODUCTS, INC. ANY INFORMATION, SPECS OR DESIGNING MAY NOT BE COPIED OR USED IN ANY WAY WITHOUT THE WRITTEN PERMISSION OF ATLANTIC MARINE PRODUCTS, INC AND IT MUST BE RETURNED UPON REQUEST

ATLANTIC MARINE PRODUCTS, INC

WCC CABIN HONDA
 ELEC SPA 2001

07/18/00 HTS 09-0039

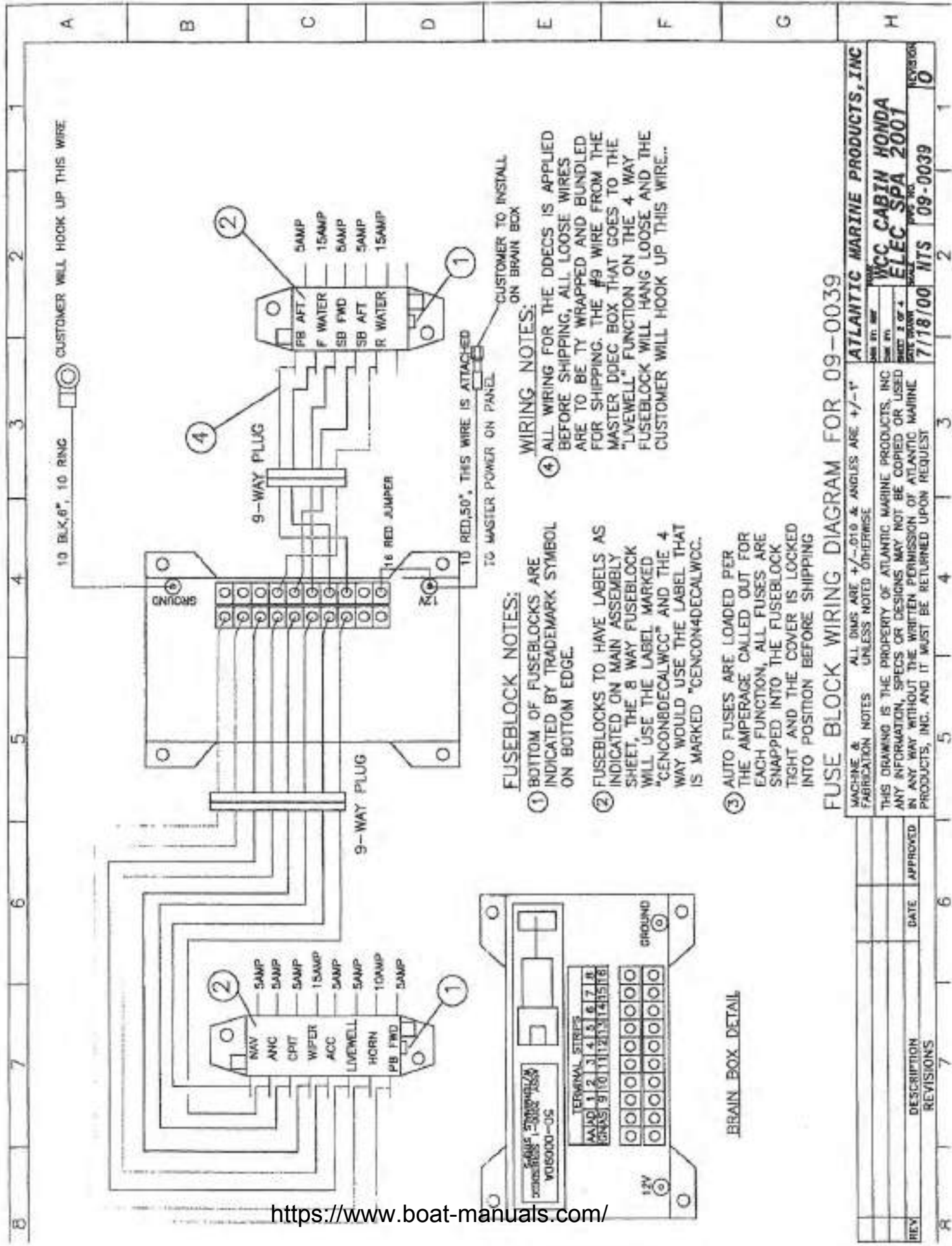

10 BLK, 6", 10 RING CUSTOMER WILL HOOK UP THIS WIRE

FUSEBLOCK NOTES:

- 1 BOTTOM OF FUSEBLOCKS ARE INDICATED BY TRADEMARK SYMBOL ON BOTTOM EDGE.
- 2 FUSEBLOCKS TO HAVE LABELS AS INDICATED ON MAIN ASSEMBLY SHEET, THE 8 WAY FUSEBLOCK WILL USE THE LABEL MARKED "GENCON8DECALWCC" AND THE 4 WAY WOULD USE THE LABEL THAT IS MARKED "GENCON4DECALWCC."
- 3 AUTO FUSES ARE LOADED PER THE AMPERAGE CALLED OUT FOR EACH FUNCTION, ALL FUSES ARE SNAPPED INTO THE FUSEBLOCK TIGHT AND THE COVER IS LOCKED INTO POSITION BEFORE SHIPPING.

FUSEBLOCK NOTES:

- 1 BOTTOM OF FUSEBLOCKS ARE INDICATED BY TRADEMARK SYMBOL ON BOTTOM EDGE.
- 2 FUSEBLOCKS TO HAVE LABELS AS INDICATED ON MAIN ASSEMBLY SHEET, THE 8 WAY FUSEBLOCK WILL USE THE LABEL MARKED "GENCON8DECALWCC" AND THE 4 WAY WOULD USE THE LABEL THAT IS MARKED "GENCON4DECALWCC."
- 3 AUTO FUSES ARE LOADED PER THE AMPERAGE CALLED OUT FOR EACH FUNCTION, ALL FUSES ARE SNAPPED INTO THE FUSEBLOCK TIGHT AND THE COVER IS LOCKED INTO POSITION BEFORE SHIPPING.

WIRING NOTES:

- 4 ALL WIRING FOR THE DECS IS APPLIED BEFORE SHIPPING, ALL LOOSE WIRES ARE TO BE TY WRAPPED AND BUNDLED FOR SHIPPING. THE #9 WIRE FROM THE MASTER DEEC BOX THAT GOES TO THE "LIVEWELL" FUNCTION ON THE 4 WAY FUSEBLOCK WILL HANG LOOSE AND THE CUSTOMER WILL HOOK UP THIS WIRE..

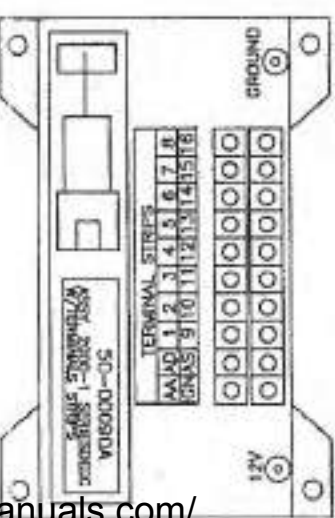

BRAIN BOX DETAIL

FUSE BLOCK WIRING DIAGRAM FOR 09-0039

MACHINE & FABRICATION NOTES		ALL DIMS ARE +/- .010 & ANGLES ARE +/- 1° UNLESS NOTED OTHERWISE	
THIS DRAWING IS THE PROPERTY OF ATLANTIC MARINE PRODUCTS, INC. ANY INFORMATION, SPECS OR DESIGNS MAY NOT BE COPIED OR USED IN ANY WAY WITHOUT THE WRITTEN PERMISSION OF ATLANTIC MARINE PRODUCTS, INC. AND IT MUST BE RETURNED UPON REQUEST			
REV	DESCRIPTION	DATE	APPROVED
REVISIONS			
1			
2			
3			
4			
5			
6			
7			
8			
ATLANTIC MARINE PRODUCTS, INC		DATE: 7/18/00	
WCC CABIN HONDA		REVISED: 09-0039	
ELEC SPA 2001		PAGE NO: 1	
REVISED: 7/18/00		REVISED: 09-0039	

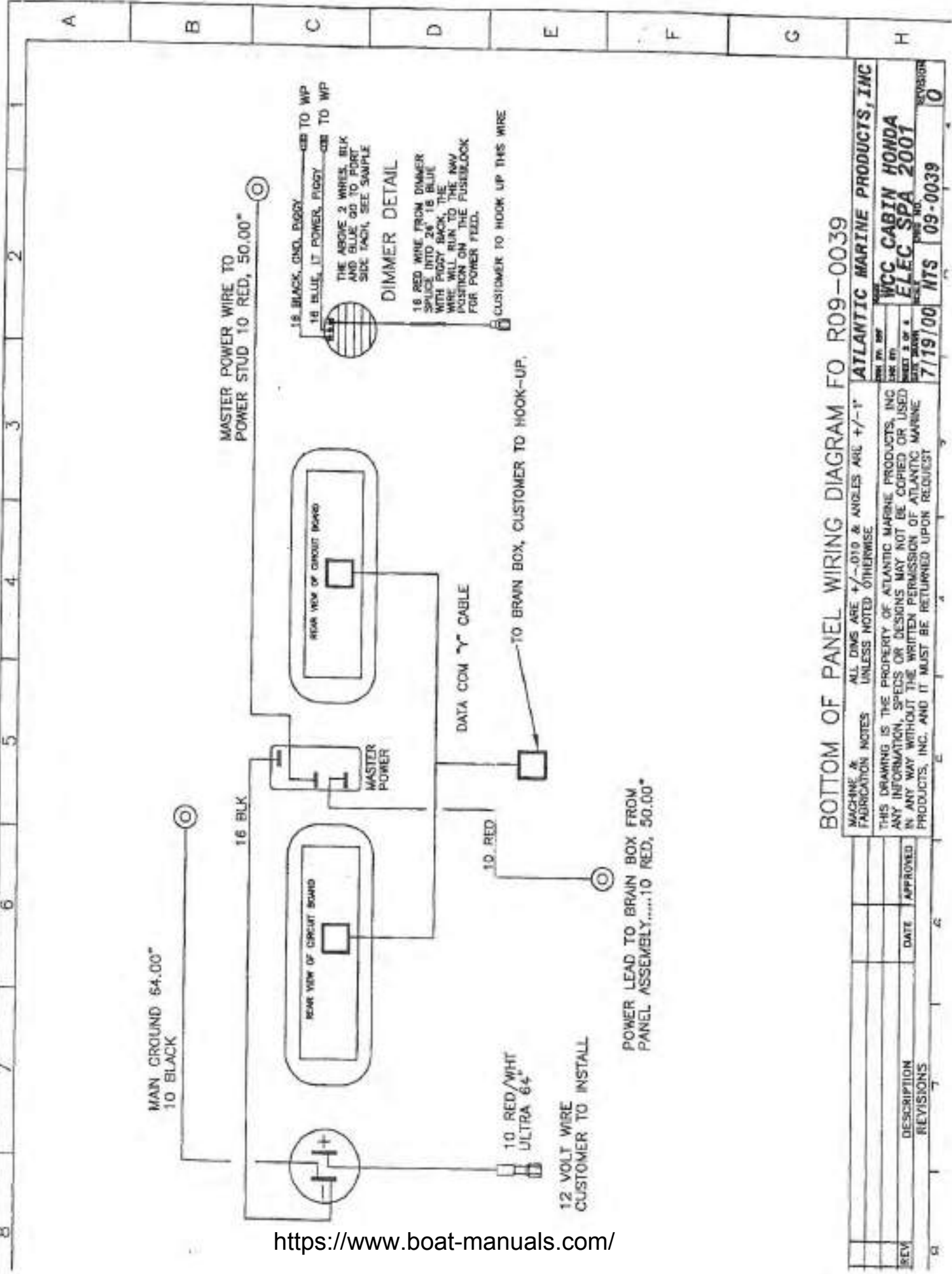

BOTTOM OF PANEL WIRING DIAGRAM FO R09-0039

MACHINE & FABRICATION NOTES		ALL DIMS ARE +/- .010 & ANGLES ARE +/- 1° UNLESS NOTED OTHERWISE	
THIS DRAWING IS THE PROPERTY OF ATLANTIC MARINE PRODUCTS, INC. ANY INFORMATION, SPECS OR DESIGNS MAY NOT BE COPIED OR USED IN ANY WAY WITHOUT THE WRITTEN PERMISSION OF ATLANTIC MARINE PRODUCTS, INC. AND IT MUST BE RETURNED UPON REQUEST		ATLANTIC MARINE PRODUCTS, INC.	
REV	DESCRIPTION	DATE	APPROVED
	REVISIONS		
WCC CABIN HONDA ELEC SPA 2001		DATE	7/19/00
REVISED BY		DATE	09-0039
DRAWING NO.		REVISED BY	0

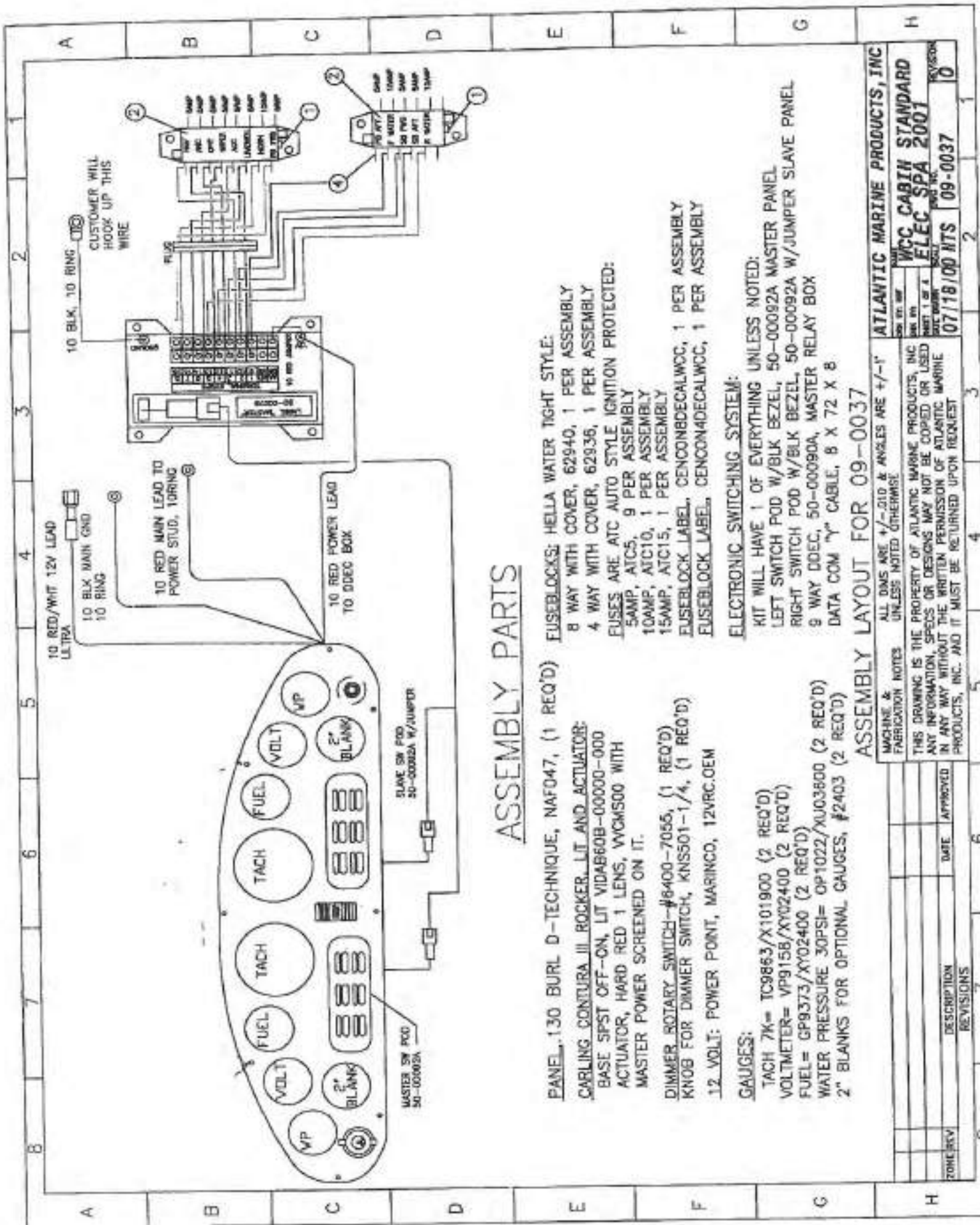

ASSEMBLY PARTS

- PANEL, 130 BURL D-TECHNIQUE, NAF047, (1 REQ'D)
- CARLING CONTURA III ROCKER, LIT AND ACTUATOR:
 BASE SPST OFF-ON, LIT VIDAB60B-00000-000
 ACTUATOR, HARD RED 1 LENS, WYCM500 WITH
 MASTER POWER SCREENED ON IT.
- DIMMER ROTARY SWITCH—#6400-7055, (1 REQ'D)
 KNOB FOR DIMMER SWITCH, KNSS01-1/4, (1 REQ'D)
- 12 VOLT: POWER POINT, MARINCO, 12VRC.OEM

- GAUGES:
- TACH 7K= TC9863/X101900 (2 REQ'D)
 - VOLTMETER= VP9158/XY02400 (2 REQ'D)
 - FUEL= GP9373/XY02400 (2 REQ'D)
 - WATER PRESSURE 30PSI= OP1022/XU03600 (2 REQ'D)
 - 2" BLANKS FOR OPTIONAL GAUGES, #2403 (2 REQ'D)

- FUSEBLOCKS: HELLA WATER TIGHT STYLE:
 8 WAY WITH COVER, 62940, 1 PER ASSEMBLY
 4 WAY WITH COVER, 62936, 1 PER ASSEMBLY
- FUSES ARE ATC AUTO STYLE IGNITION PROTECTED:
 5AMP, ATC5, 9 PER ASSEMBLY
 10AMP, ATC10, 1 PER ASSEMBLY
 15AMP, ATC15, 1 PER ASSEMBLY
- FUSEBLOCK LABEL, CENCONDECALWCC, 1 PER ASSEMBLY
- FUSEBLOCK LABEL, CENCONDECALWCC, 1 PER ASSEMBLY

- ELECTRONIC SWITCHING SYSTEM:
- KIT WILL HAVE 1 OF EVERYTHING UNLESS NOTED:
 - LEFT SWITCH POD W/BLK BEZEL, 50-00092A MASTER PANEL
 - RIGHT SWITCH POD W/BLK BEZEL, 50-00092A W/JUMPER SLAVE PANEL
 - 9 WAY DDEC, 50-00090A, MASTER RELAY BOX
 - DATA COM 7" CABLE, 8 X 72 X 8

ASSEMBLY LAYOUT FOR 09-0037

ZONE/REV	DESCRIPTION	DATE	APPROVED	REVISIONS

MACHINE & FABRICATION NOTES		ATLANTIC MARINE PRODUCTS, INC
ALL DIMS ARE +/- .010 & ANGLES ARE +/- 1° UNLESS NOTED OTHERWISE	DATE: 07/18/00	REV: 0
THIS DRAWING IS THE PROPERTY OF ATLANTIC MARINE PRODUCTS, INC. ANY INFORMATION, SPECS OR DESIGNS MAY NOT BE COPIED OR USED IN ANY WAY WITHOUT THE WRITTEN PERMISSION OF ATLANTIC MARINE PRODUCTS, INC. AND IT MUST BE RETURNED UPON REQUEST.		
WCC CABIN STANDARD	ELEC SPA 2001	REV: 0
SHEET 1 OF 4	PART NO.	09-0037

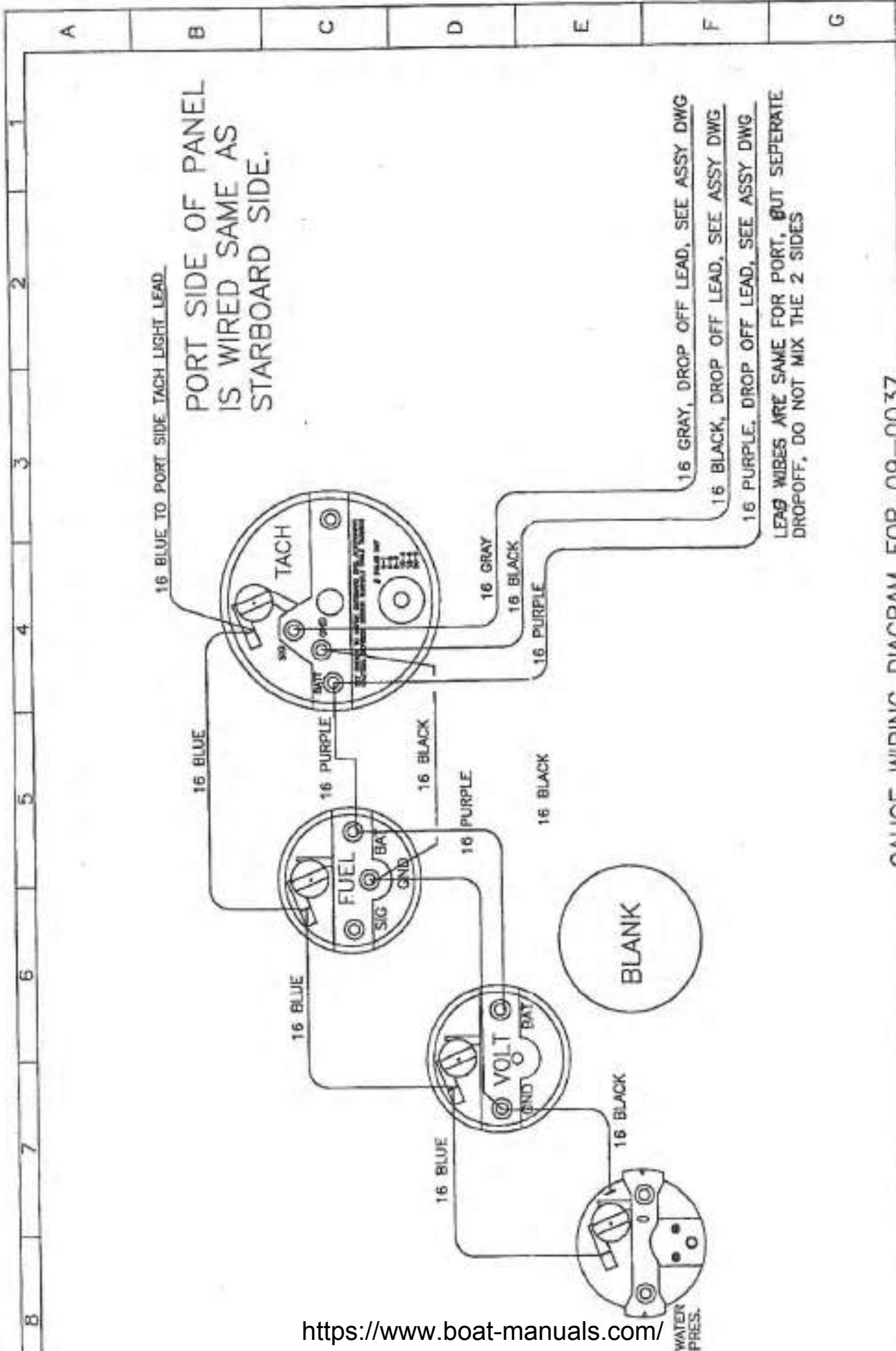

GAUGE WIRING DIAGRAM FOR 09-0037

MACHINE & FABRICATION NOTES		ALL DWS ARE +/- 0.10 & ANGLES ARE +/- 1° UNLESS NOTED OTHERWISE	
THIS DRAWING IS THE PROPERTY OF ATLANTIC MARINE PRODUCTS, INC ANY INFORMATION, SPECS OR DESIGNS MAY NOT BE COPIED OR USED IN ANY WAY WITHOUT THE WRITTEN PERMISSION OF ATLANTIC MARINE PRODUCTS, INC, AND IT MUST BE RETURNED UPON REQUEST		ATLANTIC MARINE PRODUCTS, INC	
DATE	APPROVED	DATE	APPROVED
DESCRIPTION	REVISIONS	DATE	APPROVED
WCC CABIN STANDARD ELEC SPA 2001		DATE	APPROVED
7/19/00		DATE	APPROVED
NTS 09-0037		DATE	APPROVED
REVISED		DATE	APPROVED
0		DATE	APPROVED

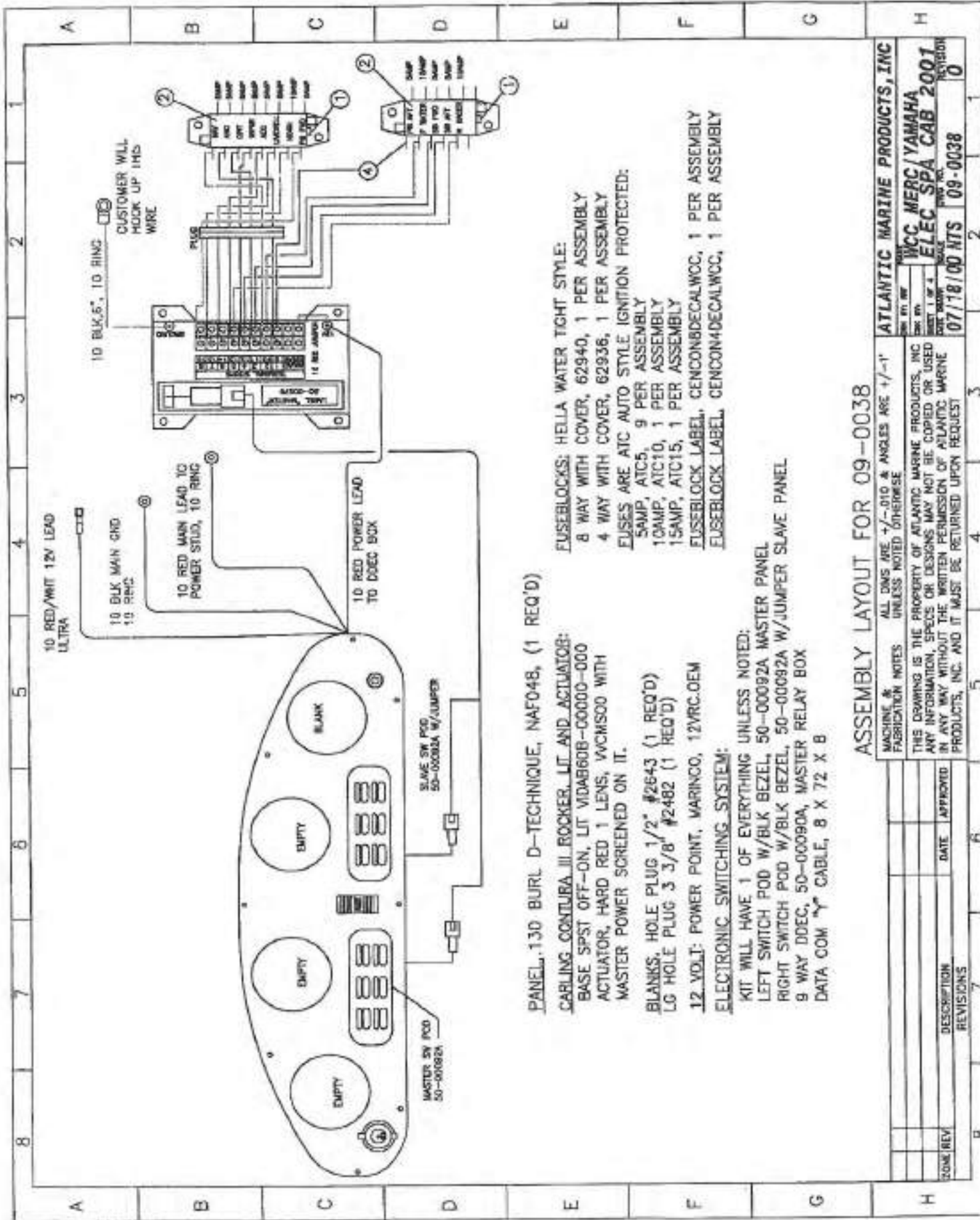

PANEL, 130 BURL D-TECHNIQUE, NAF048, (1 REQ'D)

CABLING CONTURA III ROCKER, LT AND ACTUATOR:
 BASE SPST OFF-ON, LT VDAB60B-00000-000
 ACTUATOR, HARD RED 1 LENS, WCMSC00 WITH
 MASTER POWER SCREENED ON IT.

BLANKS, HOLE PLUG 1/2" #2643 (1 REQ'D)
LG HOLE PLUG 3/8" #2482 (1 REQ'D)

12 VOLT: POWER POINT, MARINCO, 12VRC.OEM

ELECTRONIC SWITCHING SYSTEM:

KIT WILL HAVE 1 OF EVERYTHING UNLESS NOTED:
 LEFT SWITCH POD W/BLK BEZEL, 50-00092A MASTER PANEL
 RIGHT SWITCH POD W/BLK BEZEL, 50-00092A W/JUMPER SLAVE PANEL
 9 WAY DDEC, 50-00090A, MASTER RELAY BOX
 DATA COM Y CABLE, 8 X 72 X B

FUSEBLOCKS: HELLA WATER TIGHT STYLE:

8 WAY WITH COVER, 62940, 1 PER ASSEMBLY
 4 WAY WITH COVER, 62936, 1 PER ASSEMBLY

FUSES ARE ATC AUTO STYLE IGNITION PROTECTED:

5AMP, ATC5, 9 PER ASSEMBLY
 10AMP, ATC10, 1 PER ASSEMBLY
 15AMP, ATC15, 1 PER ASSEMBLY

FUSEBLOCK LABEL, CENCONBDECALWCC, 1 PER ASSEMBLY

FUSEBLOCK LABEL, CENCON4DECALWCC, 1 PER ASSEMBLY

ASSEMBLY LAYOUT FOR 09-0038

MACHINE & FABRICATION NOTES ALL DIMS ARE +/- .010 & ANGLES ARE +/- 1° UNLESS NOTED OTHERWISE

THIS DRAWING IS THE PROPERTY OF ATLANTIC MARINE PRODUCTS, INC ANY INFORMATION, SPECS OR DESIGNS MAY NOT BE COPIED OR USED IN ANY WAY WITHOUT THE WRITTEN PERMISSION OF ATLANTIC MARINE PRODUCTS, INC. AND IT MUST BE RETURNED UPON REQUEST

ATLANTIC MARINE PRODUCTS, INC	
DATE: 07/18/00	REV: NTS
BY: [Signature]	APP: [Signature]
CHK: [Signature]	DES: [Signature]
PROJ: WCC MERC / YAMAHA	PROJ NO: 09-0038
ITEM: ELEC SPA CAB 2001	REV: 0

DATE REV	DESCRIPTION	DATE	APPROVED

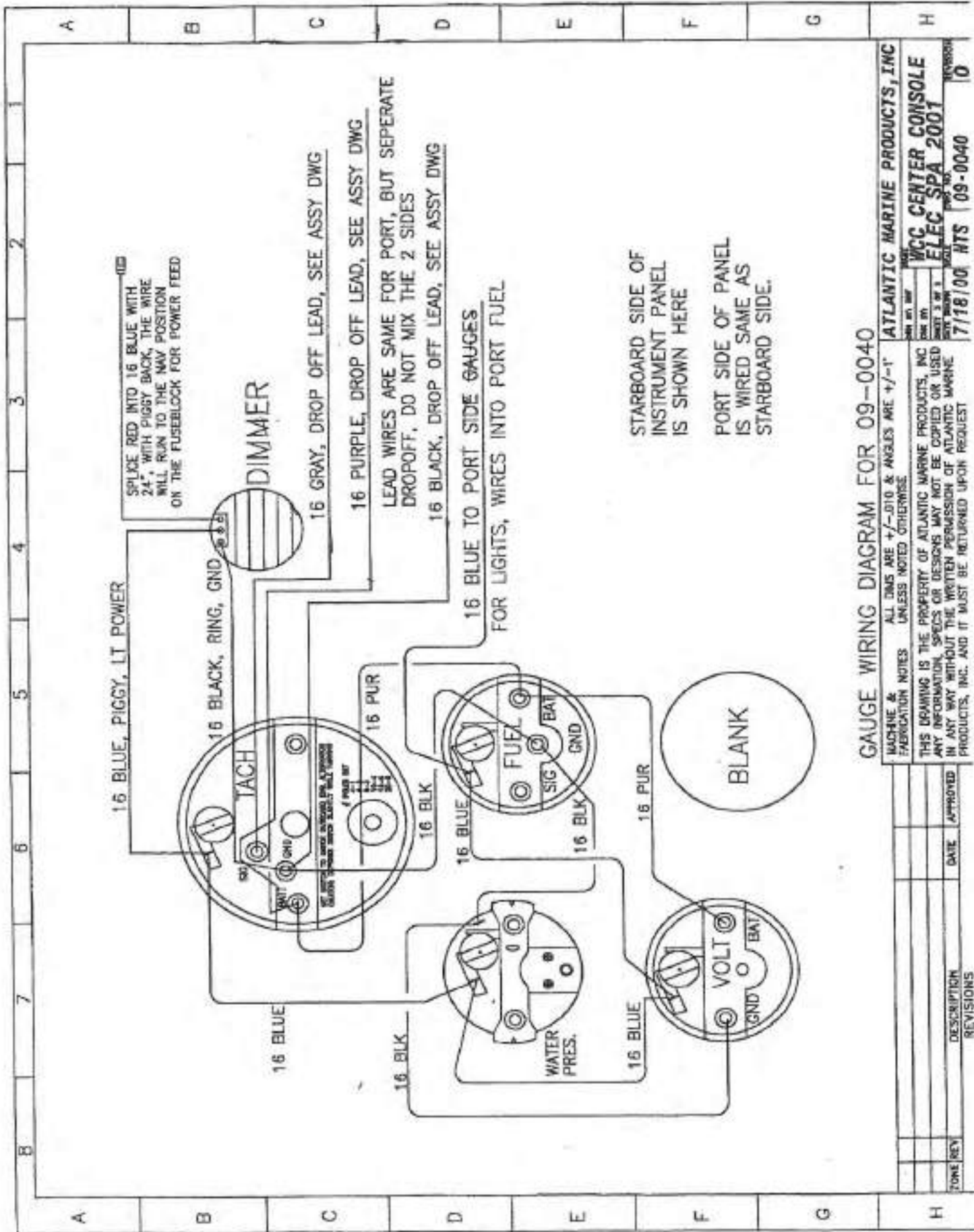

GAUGE WIRING DIAGRAM FOR 09-0040

ZONE	REV	DESCRIPTION	DATE	APPROVED

MACHINE & FABRICATION NOTES ALL DIMS ARE +/- .010 & ANGLES ARE +/- 1° UNLESS NOTED OTHERWISE
 THIS DRAWING IS THE PROPERTY OF ATLANTIC MARINE PRODUCTS, INC ANY INFORMATION, SPECS OR DESIGNS MAY NOT BE COPIED OR USED IN ANY WAY WITHOUT THE WRITTEN PERMISSION OF ATLANTIC MARINE PRODUCTS, INC. AND IT MUST BE RETURNED UPON REQUEST

ATLANTIC MARINE PRODUCTS, INC
 MCC CENTER CONSOLE
 ELEC SPA 2001
 7/18/00 HTS 09-0040

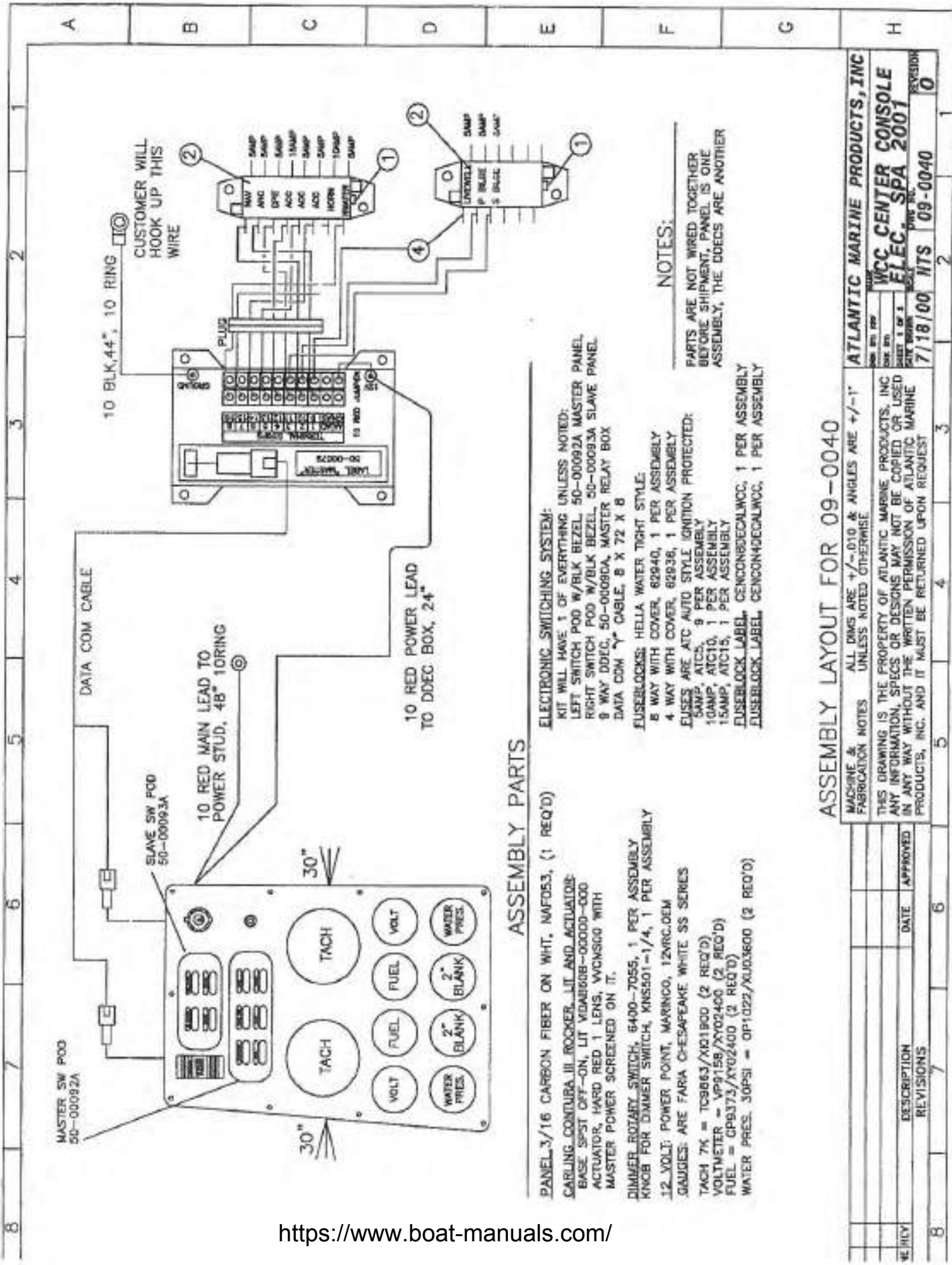

ASSEMBLY PARTS

- PANEL 3/16 CARBON FIBER ON WHT. NAF053, (1 REQ'D)
- CARLING CONTURA III ROCKER, LIT AND ACTUATOR: BASE SPST OFF-ON, LIT VIDMER08-0000-000 ACTUATOR, HARD RED 1 LENS, WGN500 WITH MASTER POWER SCREENED ON IT.
- DIMMER ROTARY SWITCH, 6400-7055, 1 PER ASSEMBLY KNOB FOR DIMMER SWITCH, KNS501-1/4, 1 PER ASSEMBLY
- 12 VOLT: POWER POINT, MARINCO, 12MRC.OEM
- GAUGES: ARE FARIA C-ESAFEAKE WHITE SS SERIES
- TACH 7K = TC9863/X101900 (2 REQ'D)
- VOLTMETER = VP9158/XY02400 (2 REQ'D)
- FUEL = GP9373/XY02400 (2 REQ'D)
- WATER PRES. 30PSI = QP1022/XUJ03600 (2 REQ'D)

- ELECTRONIC SWITCHING SYSTEM: KIT WILL HAVE 1 OF EVERYTHING UNLESS NOTED: LEFT SWITCH POD W/BLK BEZEL, 50-00092A MASTER PANEL RIGHT SWITCH POD W/BLK BEZEL, 50-00093A SLAVE PANEL 8 WAY DDEC, 50-0008DA, MASTER RELAY BOX DATA COM 7' CABLE, 8 X 72 X 8
- FUSEBLOCKS: HELLA WATER TIGHT STYLE: 8 WAY WITH COVER, 82940, 1 PER ASSEMBLY 4 WAY WITH COVER, 82938, 1 PER ASSEMBLY
- FUSES ARE ATC AUTO STYLE IGNITION PROTECTED: 5AMP, ATC5, 9 PER ASSEMBLY 10AMP, ATC10, 1 PER ASSEMBLY 15AMP, ATC15, 1 PER ASSEMBLY
- FUSEBLOCK LABEL: CENCON8DECALWCC, 1 PER ASSEMBLY FUSEBLOCK LABEL: CENCON40CCALWCC, 1 PER ASSEMBLY

NOTES:
PARTS ARE NOT WIRED TOGETHER BEFORE SHIPMENT, PANEL IS ONE ASSEMBLY, THE DDECS ARE ANOTHER

ASSEMBLY LAYOUT FOR 09-0040

REV	DESCRIPTION	DATE	APPROVED

MACHINE & FABRICATION NOTES ALL DIMS ARE +/- .010 & ANGLES ARE +/- 1° UNLESS NOTED OTHERWISE
THIS DRAWING IS THE PROPERTY OF ATLANTIC MARINE PRODUCTS, INC. ANY INFORMATION, SPECS OR DESIGNS MAY NOT BE COPIED OR USED IN ANY WAY WITHOUT THE WRITTEN PERMISSION OF ATLANTIC MARINE PRODUCTS, INC. AND IT MUST BE RETURNED UPON REQUEST

ATLANTIC MARINE PRODUCTS, INC
 WCC CENTER CONSOLE
 ELEC. SPA 2001
 7/18/00 NTS 09-0040
 SHEET 1 OF 3
 REV 0

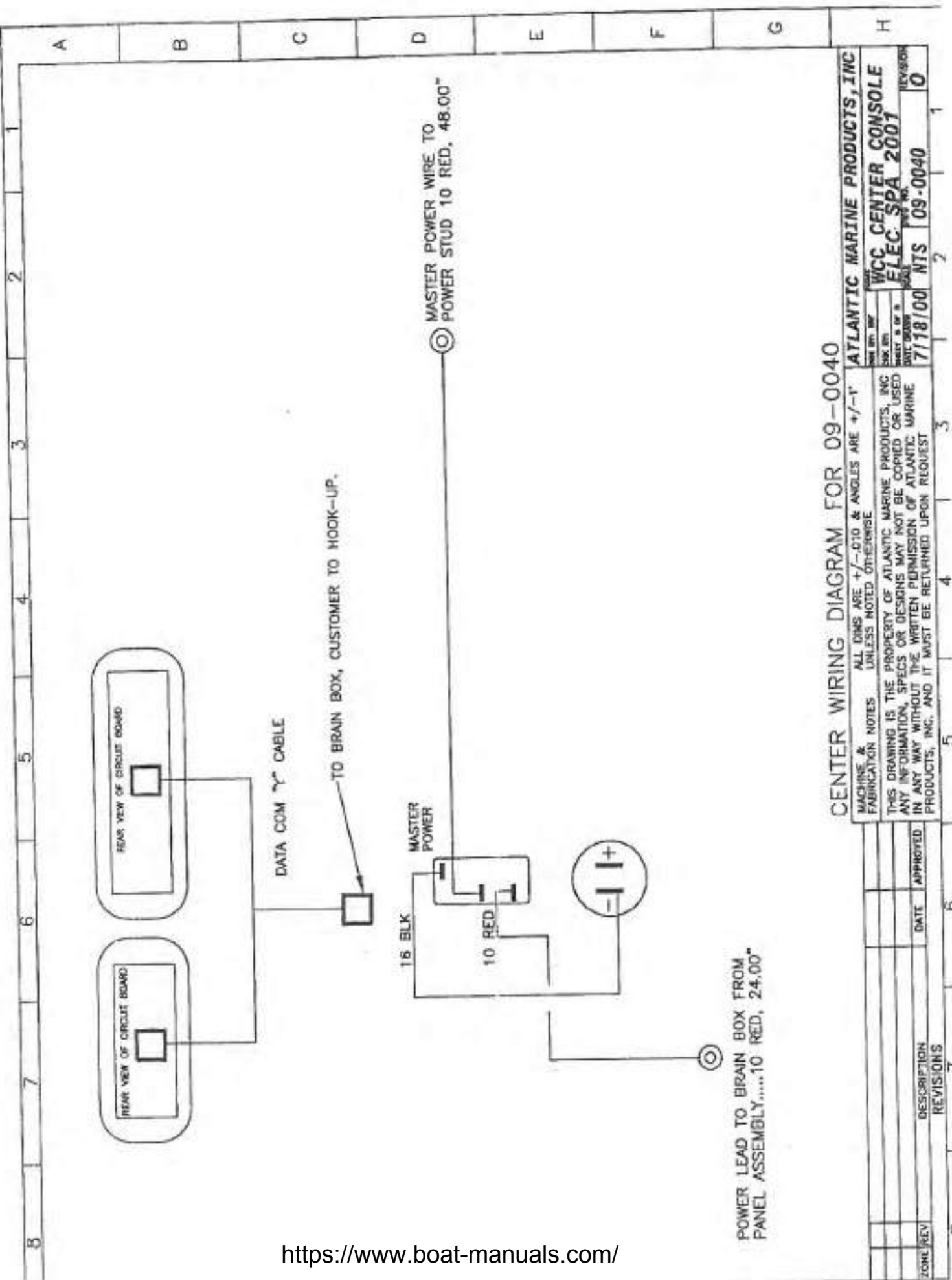

CENTER WIRING DIAGRAM FOR 09-0040

MACHINE & FABRICATION NOTES		ALL DIMS ARE +/- .010 & ANGLES ARE +/- 1° UNLESS NOTED OTHERWISE	
THIS DRAWING IS THE PROPERTY OF ATLANTIC MARINE PRODUCTS, INC. ANY INFORMATION, SPECS OR DESIGNS MAY NOT BE COPIED OR USED IN ANY WAY WITHOUT THE WRITTEN PERMISSION OF ATLANTIC MARINE PRODUCTS, INC. AND IT MUST BE RETURNED UPON REQUEST		ATLANTIC MARINE PRODUCTS, INC.	
DATE	REV	DATE	REV
7/18/00	NTS	09-0040	0
WCC CENTER CONSOLE		ELEC SPA 2001	
REVISION		REV	

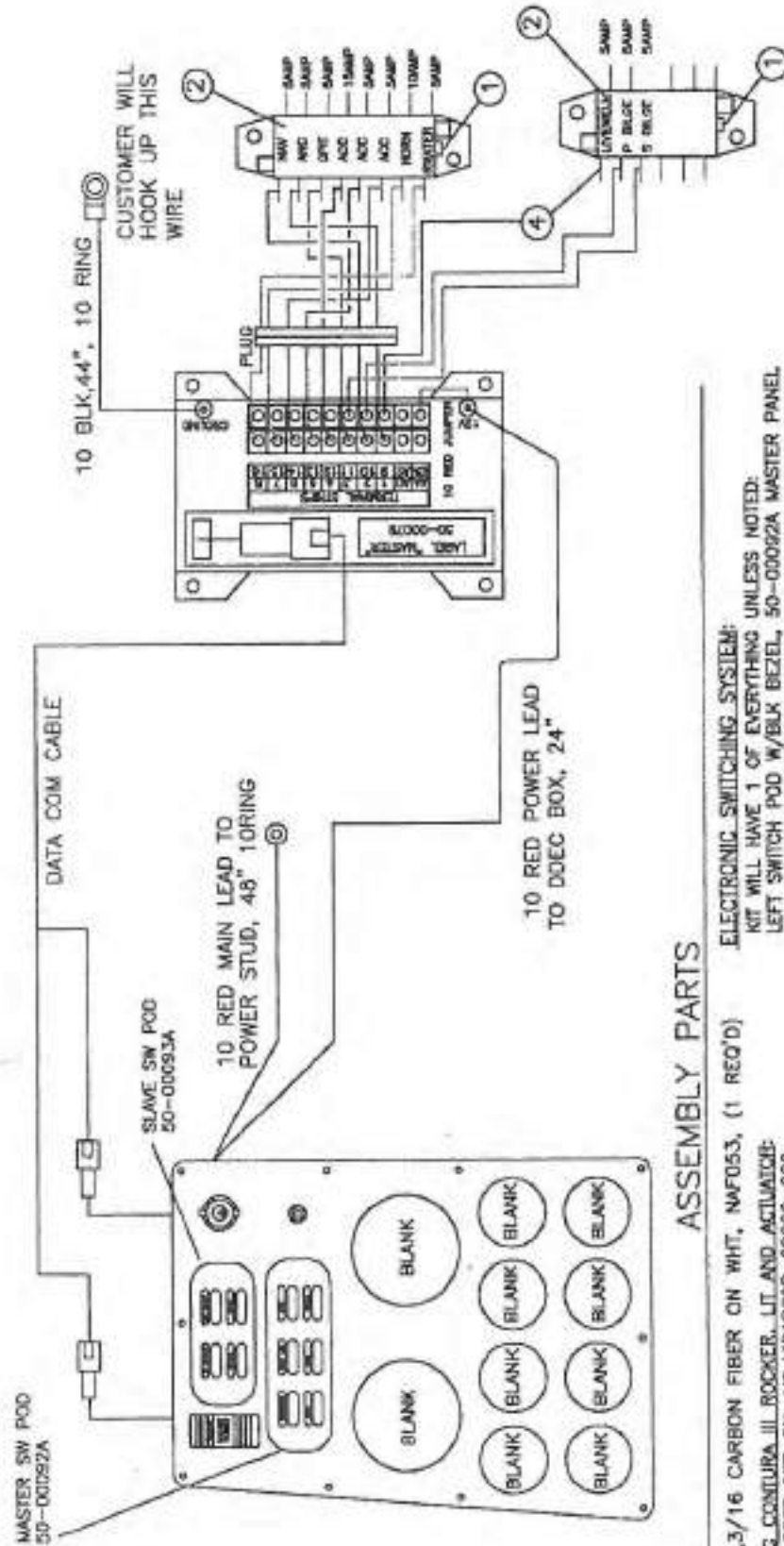

NOTES:

PARTS ARE NOT WIRED TOGETHER BEFORE SHIPMENT. PANEL IS ONE ASSEMBLY, THE DDECS ARE ANOTHER

ASSEMBLY PARTS

- PANEL 3/16 CARBON FIBER ON WHT, NAF053, (1 REQ'D)
- ELECTRONIC SWITCHING SYSTEM:
 - KIT WILL HAVE 1 OF EVERYTHING UNLESS NOTED:
 - LEFT SWITCH POD W/BLK BEZEL, 50-00092A MASTER PANEL
 - RIGHT SWITCH POD W/BLK BEZEL, 50-00093A SLAVE PANEL
 - 9 WAY DDEC, 50-00090A, MASTER RELAY BOX
 - DATA COM "Y" CABLE, 8 X 72 X 8
- FUSEBLOCKS: HELLA WATER TIGHT STYLE:
 - 8 WAY WITH COVER, 82940, 1 PER ASSEMBLY
 - 4 WAY WITH COVER, 82936, 1 PER ASSEMBLY
- FUSES ARE ATC AUTO STYLE IGNITION PROTECTED:
 - 5AMP, ATC5, 9 PER ASSEMBLY
 - 10AMP, ATC10, 1 PER ASSEMBLY
 - 15AMP, ATC15, 1 PER ASSEMBLY
- FUSEBLOCK LABEL, CENCON160CALWCC, 1 PER ASSEMBLY
- FUSEBLOCK LABEL, CENCON40CALWCC, 1 PER ASSEMBLY
- DIMMER ROTARY SWITCH, 8400-7055, 1 PER ASSEMBLY
- KNOB FOR DIMMER SWITCH, KMS501-1/4, 1 PER ASSEMBLY
- 12 VOLT: POWER POINT, MARINCO, 12VRC.0EM

ASSEMBLY LAYOUT FOR 09-0042

REV	DESCRIPTION	DATE	APPROVED
REV3			
REV2			
REV1			
REV0			

MACHINE & FABRICATION NOTES		ALL DIMS ARE +/- .010 & ANGLES ARE +/- .1° UNLESS NOTED OTHERWISE	
DATE	7/18/00	NTS	09-0042
SCALE	AS SHOWN	REVISION	REV
THIS DRAWING IS THE PROPERTY OF ATLANTIC MARINE PRODUCTS, INC. IN ANY INFORMATION, SPECS OR DESIGNS MAY NOT BE COPIED OR USED IN ANY WAY WITHOUT THE WRITTEN PERMISSION OF ATLANTIC MARINE PRODUCTS, INC. AND IT MUST BE RETURNED UPON REQUEST		ATLANTIC MARINE PRODUCTS, INC WCC CENTER CONSOLE ELEC SPA HONDA 2001	

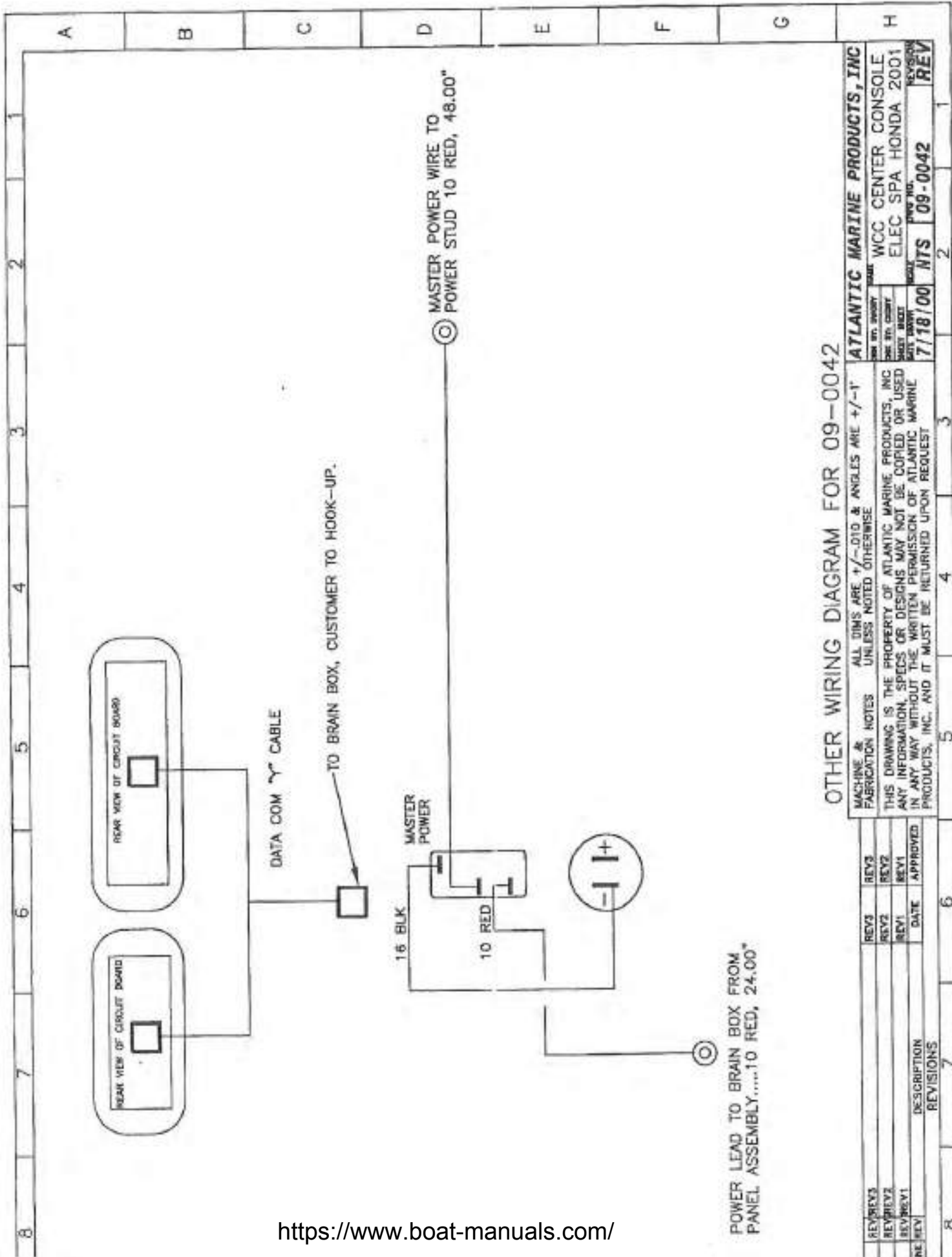

POWER LEAD TO BRAIN BOX FROM
 PANEL ASSEMBLY.....10 RED, 24.00"

OTHER WIRING DIAGRAM FOR 09-0042

REV	REV	DATE	APPROVED	DESCRIPTION	REV	REV	DATE	APPROVED	DESCRIPTION
REV03	REV3								
REV02	REV2								
REV01	REV1								

MACHINE & FABRICATION NOTES		ALL DIMS ARE +/- .010 & ANGLES ARE +/- 1° UNLESS NOTED OTHERWISE	
THIS DRAWING IS THE PROPERTY OF ATLANTIC MARINE PRODUCTS, INC. ANY INFORMATION, SPECS OR DESIGNS MAY NOT BE COPIED OR USED IN ANY WAY WITHOUT THE WRITTEN PERMISSION OF ATLANTIC MARINE PRODUCTS, INC. AND IT MUST BE RETURNED UPON REQUEST			
DATE	BY	REV	DESCRIPTION
7/18/00	HTS	09-0042	REV

ATLANTIC MARINE PRODUCTS, INC
 WCC CENTER CONSOLE
 ELEC SPA HONDA 2001
 DATE 7/18/00
 BY HTS
 REV 09-0042

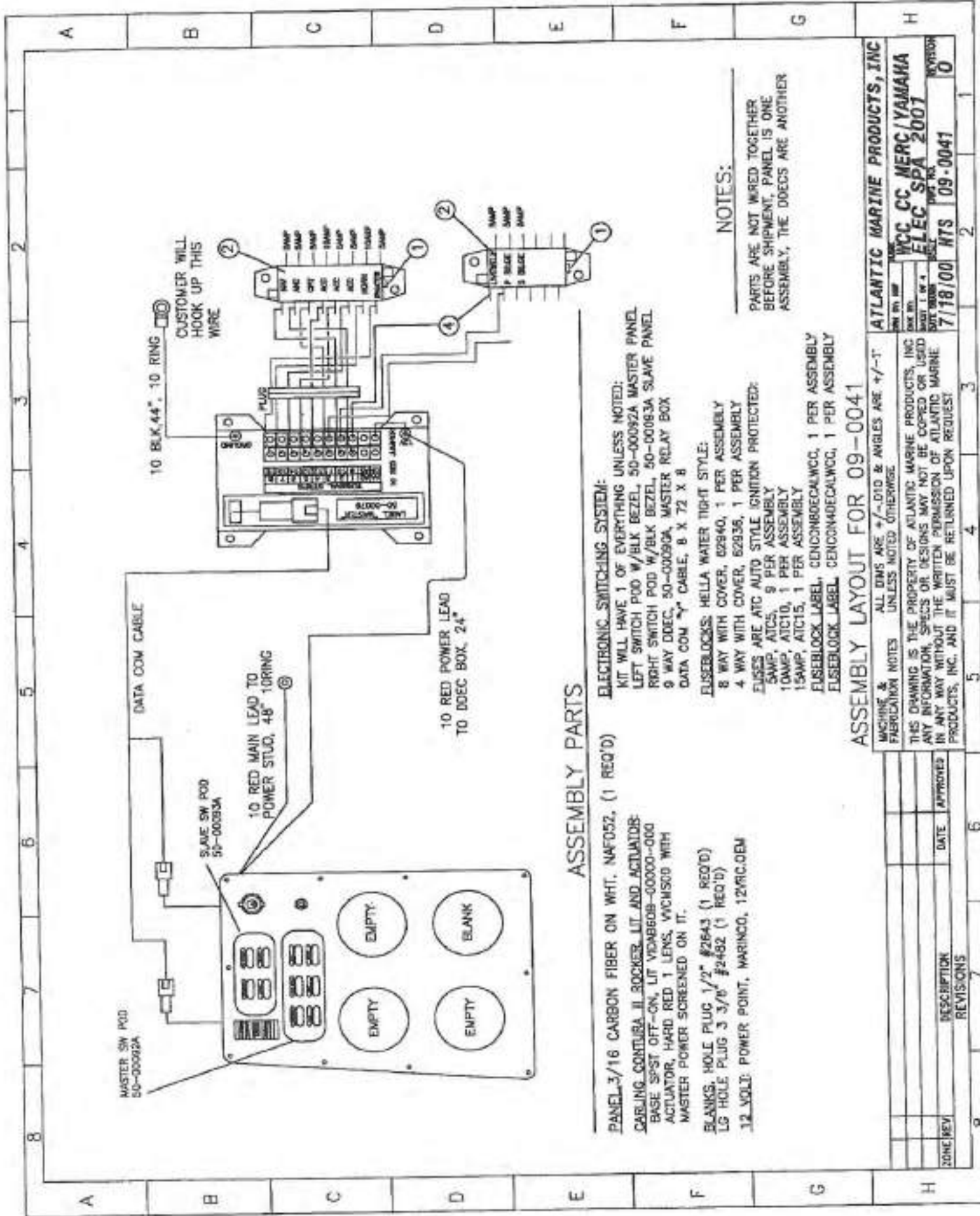

ASSEMBLY PARTS

- PANEL 3/16 CARBON FIBER ON WHT. NAF052, (1 REQ'D)
 - CABLEING: CORTURA II 30CKER, LIT AND ACTUATORS:
 - BASE SPST OFF-ON, LIT VDA860B-00000-000
 - ACTUATOR, HARD RED 1 LENS, VVCM500 WITH MASTER POWER SCREENED ON IT.
 - BLANKS, HOLE PLUG 1/2" #2643 (1 REQ'D)
 - LG HOLE PLUG 3 3/8" #2482 (1 REQ'D)
 - 12 VOLT: POWER POINT, MARINCO, 12VRC.0EM
- ELECTRONIC SWITCHING SYSTEM:**
- KIT WILL HAVE 1 OF EVERYTHING UNLESS NOTED:
 - LEFT SWITCH POD W/BLK BEZEL, 50-00092A MASTER PANEL
 - RIGHT SWITCH POD W/BLK BEZEL, 50-00083A SLAVE PANEL
 - 9 WAY DDEC, 50-00090A, MASTER RELAY BOX
 - DATA COM 4" CABLE, 8 X 72 X 8
- FUSEBLOCKS: HELLA WATER TIGHT STYLE:**
- 8 WAY WITH COVER, 62940, 1 PER ASSEMBLY
 - 4 WAY WITH COVER, 62936, 1 PER ASSEMBLY
- FUSES ARE ATC AUTO STYLE IGNITION PROTECTED:**
- 5AMP, ATC5, 9 PER ASSEMBLY
 - 10AMP, ATC10, 1 PER ASSEMBLY
 - 15AMP, ATC15, 1 PER ASSEMBLY
- FUSEBLOCK LABEL, CENCOM80CALWCC, 1 PER ASSEMBLY**
- FUSEBLOCK LABEL, CENCOM40CALWCC, 1 PER ASSEMBLY**

NOTES:

PARTS ARE NOT WIRED TOGETHER BEFORE SHIPMENT. PANEL IS ONE ASSEMBLY, THE DDECS ARE ANOTHER

ASSEMBLY LAYOUT FOR 09-0041

MACHINE & FABRIKATION NOTES	ALL DIMS ARE +/- .010 & ANGLES ARE +/- .1"
UNLESS NOTED OTHERWISE	
THIS DRAWING IS THE PROPERTY OF ATLANTIC MARINE PRODUCTS, INC ANY INFORMATION, SPECS OR DESIGNS MAY NOT BE COPIED OR USED IN ANY WAY WITHOUT THE WRITTEN PERMISSION OF ATLANTIC MARINE PRODUCTS, INC. AND IT MUST BE RETURNED UPON REQUEST	
ZONE/REV	DESCRIPTION
DATE	APPROVED
REVISIONS	

ATLANTIC MARINE PRODUCTS, INC

WCC CC MERC / YAMAHA

ELEC SPA 2007

DATE: 7/18/00

REV: 09-0041

REV. NO. 0

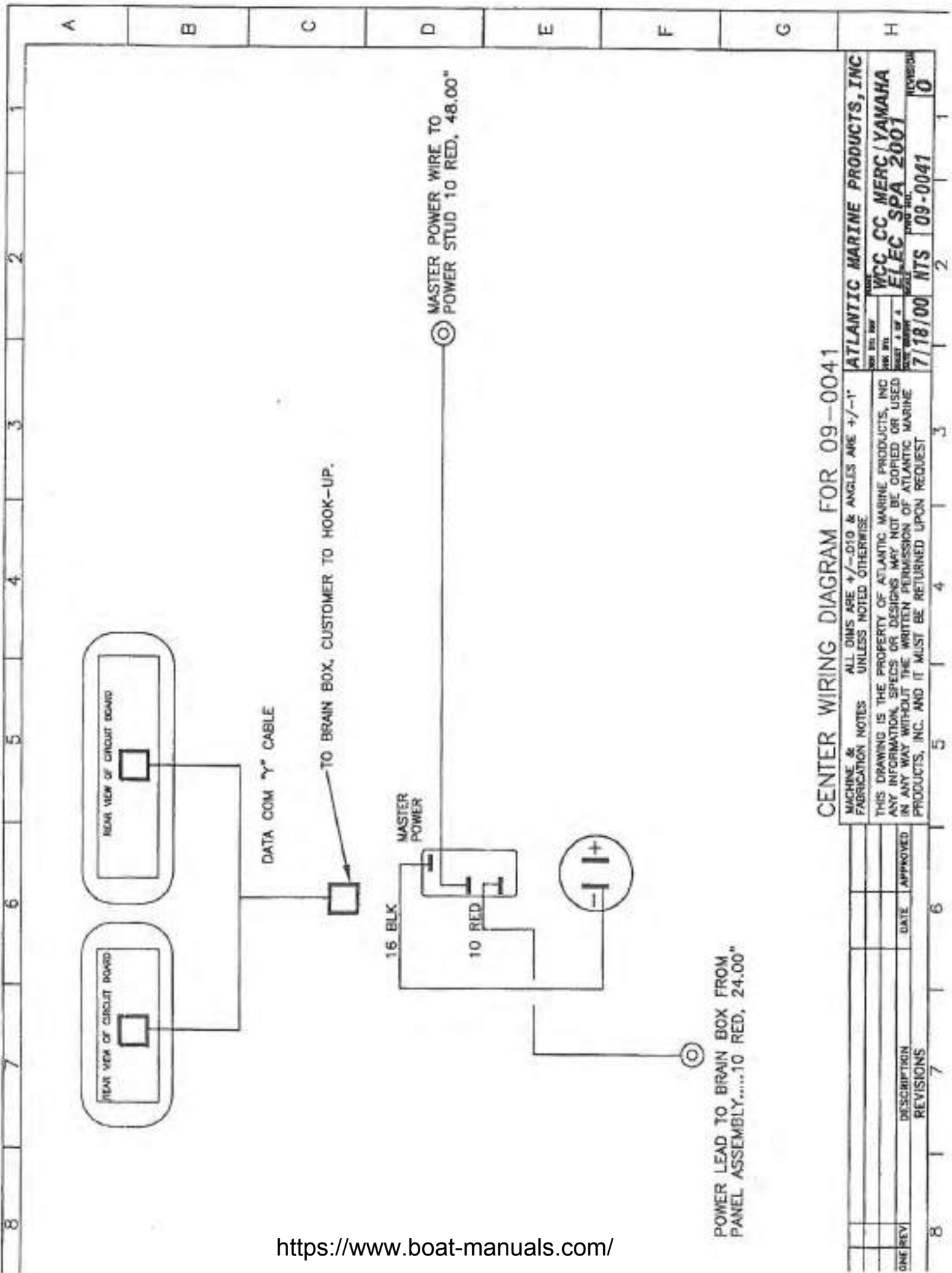

CENTER WIRING DIAGRAM FOR 09-0041

ONE REV	DATE	APPROVED	DESCRIPTION	REVISIONS
MACHINE & FABRICATION NOTES ALL DIMS ARE +/- .010 & ANGLES ARE +/- .1° UNLESS NOTED OTHERWISE				
THIS DRAWING IS THE PROPERTY OF ATLANTIC MARINE PRODUCTS, INC ANY INFORMATION, SPECS OR DESIGNS MAY NOT BE COPIED OR USED IN ANY WAY WITHOUT THE WRITTEN PERMISSION OF ATLANTIC MARINE PRODUCTS, INC. AND IT MUST BE RETURNED UPON REQUEST				
WCC CC MERC / YAMAHA		ELEC SPA 2001		
ATLANTIC MARINE PRODUCTS, INC		7/18/00 NTS 09-0041		
DATE		REVISION		
7/18/00		0		

THIS DRAWING IS THE PROPERTY OF ATLANTIC MARINE PRODUCTS, INC. ANY INFORMATION, SPECS OR DESIGNS MAY NOT BE COPIED OR USED IN ANY WAY WITHOUT THE WRITTEN PERMISSION OF ATLANTIC MARINE PRODUCTS, INC. AND IT MUST BE RETURNED UPON REQUEST

ZONE/REV	REVISIONS DESCRIPTION	DATE	APPROVED

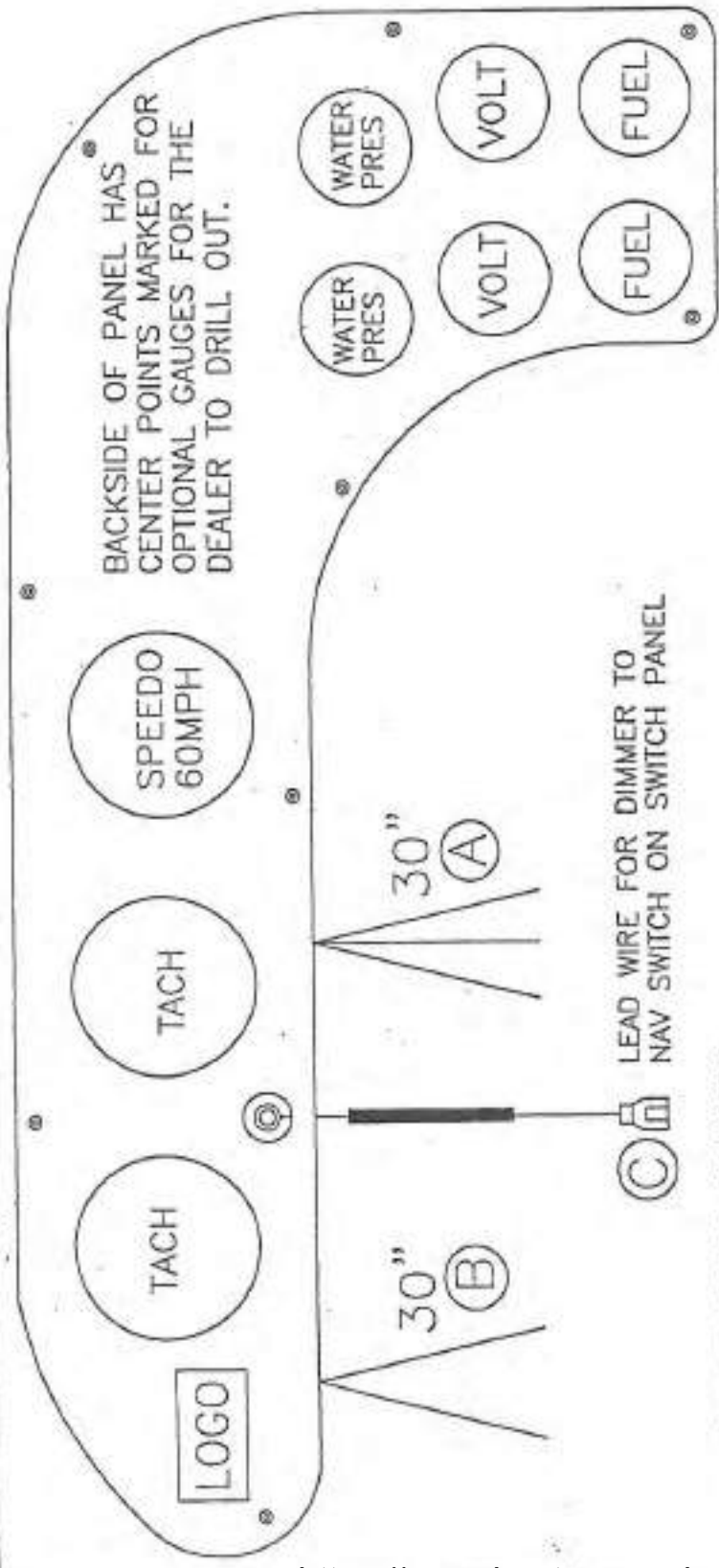

BACKSIDE OF PANEL HAS CENTER POINTS MARKED FOR OPTIONAL GAUGES FOR THE DEALER TO DRILL OUT.

LEAD WIRE FOR DIMMER TO NAV SWITCH ON SWITCH PANEL

ASSEMBLY PARTS

- GAUGES ARE FARIA CHESAPEAKE WHITE SS SERIES
- TACH 7K = TC9863 / X101900 (2 REQ'D)
- VOLTMETER = VP9158 / XY02400 (2 REQ'D)
- FUEL = GP9373 / XY02400 (2 REQ'D)
- WATER PRES. 30PSI = OP1022 / XU03600 (2 REQ'D)
- SPEEDO, 60MPH = SE9521 / X101900 (1 REQ'D)
- TAPE FOR BACKSIDE OF PANEL, APPROX 66", PE1612 X 1/2
- DIMMER ROTARY SWITCH FOR GAUGE LIGHTS, 6400-7055
- KNOB FOR DIMMER, KNS501-1/4 (1 REQ'D)
- PANEL, MACHINED & ENGRAVED, NAF023 (1 REQ'D)

WIRE DROP NOTES

- A 16 BLACK, 16 GRAY, 16 PURPLE FROM STBD SIDE OF GAUGES, NO TERMINALS ON WIRES. THESE WIRES ARE TIED TOGETHER AND ARE RUN SEPARATE FROM PORT LEAD WIRES. PORT DOES NOT HAVE BLACK
- B SAME AS ABOVE BUT FOR PORT
- C LEAD WIRE FROM DIMMER SWITCH CUSTOMER TO HOOK UP TO NAV SWITCH ON SWITCH PANEL ASSEMBLY

FINAL ASSEMBLY 09-0021
CUST NUMBER 21-248

MACHINE & FABRICATION NOTES	
ALL DIMS ARE +/- .010 & ANGLES ARE +/- 1° UNLESS NOTED OTHERWISE	FINISHED EDGES ARE INDICATED BY FINISH MARK
PERMETER EDGES ARE TO BE FINISHED, BREAK ALL SHARP EDGES AND CORNERS. PARTS ARE TO BE CLEAR AND FREE OF DIBERS.	DATE DRAWING ISSUED: 26MCH99
ATLANTIC MARINE PRODUCTS, INC	1:1 09-0021
WORLD CLASS CATAMARAN	REVISION 0
LEISURE CAT INST PANEL	

THIS DRAWING IS THE PROPERTY OF ATLANTIC MARINE PRODUCTS, INC. ANY INFORMATION, SPECS OR DESIGNS MAY NOT BE COPIED OR USED IN ANY WAY WITHOUT THE WRITTEN PERMISSION OF ATLANTIC MARINE PRODUCTS, INC. AND IT MUST BE RETURNED UPON REQUEST

ZONE	REV	DESCRIPTION	DATE	APPROVED

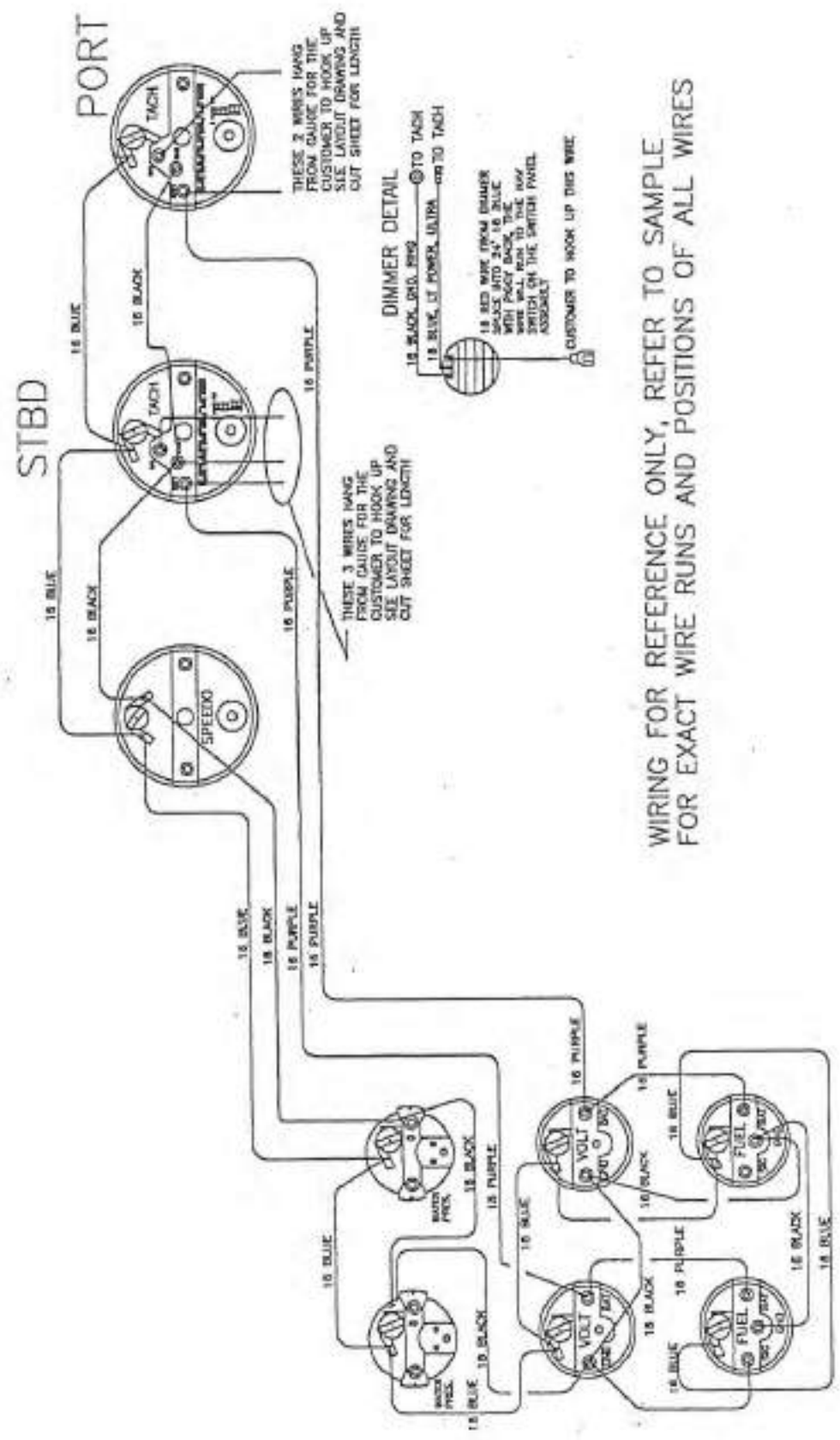

WIRING FOR REFERENCE ONLY, REFER TO SAMPLE FOR EXACT WIRE RUNS AND POSITIONS OF ALL WIRES

FINAL WIRING ASSEMBLY 09-0021

MACHINE & FABRICATION NOTES ALL DIMS ARE +/- .010 & ANGLES ARE +/- 1° UNLESS NOTED OTHERWISE FINISHED EDGES ARE INDICATED BY FINISH MARKS PERMETER EDGES ARE TO BE FINISHED. BREAK ALL SHARP EDGES AND CORNERS. PARTS ARE TO BE CLEAR AND FREE OF DEBRIS.	ATLANTIC MARINE PRODUCTS, INC. ORIN BY: CUMMINS CHK BY: GMM SHEET 1 OF 1 DATE DRAWN: 20MCH99 REV. NO. NTS 09-0021	WORLD CLASS CATAMARAN LEISURE CAT INST PANEL	REV. NO. 0
--	--	--	------------