

1998
WORLD CATTM
OWNERS MANUAL

TABLE OF CONTENTS

WELCOME!	i
OWNER SATISFACTION MESSAGE	ii
LIMITED WARRANTY STATEMENT	1
COMPONENTS SUPPLIER LIST	2
ADVISORY LABELS	3
CARE & GENERAL INFORMATION	4 - 5
RIGGING GUIDELINES	6
STEERING SYSTEM	7 - 8
FUEL SYSTEM (all models)	9
FRESH and RAW WATER SYSTEMS	10 - 12
BAITWELL SYSTEM	13
ELECTRICAL SYSTEM & BATTERY INFORMATION	14
WIRING CODE	15
GAUGE TROUBLESHOOTING QUICK REFERENCE	16
INSTRUMENTATION DATA	17 - 20
DETAILS OF SWITCH WIRING	21 - 22
SWITCH and INSTRUMENT PANEL DIAGRAMS	23 - 34
WINDLASS WIRING DIAGRAM	35
WINDLASS OPERATION & MAINTENANCE	36 - 37
TRAILER BRAKE REQUIREMENTS	38

FOR FURTHER INFORMATION, CONTACT YOUR **WORLD CAT**TM DEALER, OR:

WCC GROUP, INC.
ATTN: CUSTOMER SERVICE
801 STATON RD.
GREENVILLE, NC
919/754-1948
FAX 919/754-1949
e-mail worldcat@worldclasscat.com

WCC Group, Inc.
World Cat Limited Warranty

WARRANTY COVERAGE

WCC Group, Inc. (hereinafter referred to as the **Manufacturer**) warrants to the original purchaser, or approved transferee, that the boat, and all components and accessories manufactured by the Manufacturer shall be free from defects in materials and workmanship for a period of one (1) year from the date of original purchase, and further, that the hull and deck will be free from structural defects caused by faulty materials or workmanship for a period of five (5) years from the date of original purchase from the Manufacturer's authorized dealer. It is further warranted that the gelcoat surface of the hull bottom will be free from blistering that may occur as a result of defects in materials and workmanship for a period of five (5) years from the date of original purchase from an authorized dealer, provided that the gelcoat surface has not been altered in any way such as sanding or sandblasting, or the application of a coating other than a standard type of anti-fouling paint and primer coating, which will void this warranty provision. Products that are proven to be defective within the applicable warranty period, when used and maintained according to the manufacturer's instructions, will be repaired or replaced by the Manufacturer, or one of its authorized dealers, at the option of the Manufacturer, and only after prior authorization of the Manufacturer. All warranty claims in excess of \$ 200.00 may require substantiation prior to authorization, at the option of the Manufacturer. This warranty may be transferred by following the procedures in the Owner's Manual. This warranty provides specific legal rights; other rights may be applicable according to local statutes.

LIMITATIONS

Warranty coverage does not extend to any Purchaser other than the original purchaser from the Manufacturer's authorized dealer, or an approved transferee. Warranty coverage does not include:

1. Outboard motors, propellers, batteries, anti-fouling paint or any component or accessory not manufactured by the Manufacturer. Refer to the Owner's Manual for specific warranty details on components and accessories.
2. Gelcoat cracking, crazing or discoloration.
3. Damage caused by misuse or abuse, racing, storm damage, grounding, commercial use of the boat, or normal deterioration.
4. Upholstery damage or deterioration.
5. Damage or deterioration resulting from environmental conditions.
6. Any repairs, adjustments or modifications to a boat or any of its components made by anyone other than an employee of WCC Group, Inc.
7. Damage which has occurred as a result of the boat being operated as a demonstrator and/or displayed for sale.
8. Damage or deterioration of the boat or its components due to attachment of hardware or other components by anyone other than an employee of the Manufacturer.

Repair or replacement, at the option of the Manufacturer, is the exclusive remedy under this warranty; in no event shall the Manufacturer be liable for any consequential or incidental damages, including, but not limited to, telephone, food, lodging, or charges for transportation or hauling out in order to effect warranty repair, unless provided for under local statute, in which case these exclusions may not be applicable. TO THE EXTENT ALLOWED BY LAW, ANY AND ALL IMPLIED WARRANTIES, INCLUDING THE IMPLIED WARRANTY OF MERCHANTABILITY AND ANY APPLICABLE IMPLIED WARRANTY OF FITNESS FOR A PARTICULAR PURPOSE ARE LIMITED TO THE DURATION OF THIS WARRANTY, UNLESS PRESCRIBED BY LOCAL STATUTE. The rights and obligations of the Purchaser and the Manufacturer under this written warranty may not be varied or modified.

RESPONSIBILITY OF THE PURCHASER

1. This warranty extends ONLY TO THE ORIGINAL PURCHASER OR AN APPROVED TRANSFEREE ON THE CONDITION the owner completes and mails the warranty card to WCC Group, Inc., Warranty Registration, 801 Staton Rd., Greenville, NC 27834 within fifteen (15) days after taking delivery of the boat.
2. The original purchaser or approved transferee must give WRITTEN NOTICE of the claimed defect to an authorized dealer within fifteen (15) days after first detecting the claimed defect. It must appear to the Manufacturer's reasonable satisfaction that the claimed defect is covered by warranty. Purchaser must give WRITTEN NOTICE to WCC Group, Inc., Warranty Claims, of any failure by an authorized dealer to respond to a claimed defect within fifteen (15) days after first notification to the authorized dealer.
3. The boat, including any claimed defective part, MUST be returned to an authorized dealer for the Manufacturer (or elsewhere, as directed by the Manufacturer) within the warranty period for inspection and warranty service. ALL EXPENSES incurred in returning the boat to the authorized dealer and back to the owner will be paid by the owner.

THIS FORM MUST BE COMPLETED AND SIGNED AT THE TIME OF DELIVERY AND THE APPROPRIATE COPIES RETURNED IMMEDIATELY TO FACILITATE THE HANDLING OF ANY CLAIM THAT MAY ARISE UNDER THE TERMS OF THIS LIMITED WARRANTY AND TO COMPLY WITH THE FEDERAL BOATING SAFETY ACT OF 1971.

WCC Group, Inc. reserves the right to modify its products through changes in design and/or material without notice and without obligation to the owners of similar and/or same models of prior manufacture. We may be contacted at WCC Group, Inc., Customer Service, 801 Staton Rd., Greenville, NC 27834.

WORLD CATTM
COMPONENTS SUPPLIER LIST

<u>SUPPLIER</u>	<u>PRODUCT(S)</u>	<u>WARRANTY</u>	<u>TELEPHONE #</u>
A.J. Canvas	Enclosures	1 yr.	Contact WCC
Armstrong Nautical Products	Bow Pulpit & Swim Ladder	3 yrs.	800/226-7204
Aqua Power (Morse)	Fuel Filters	1 yr.	800/404-3951
Atlantic Marine Products	Electrical Panels	1 yr.	757/498-4195
Bomar	Cabin & Console Portlights	1 yr.	603/826-5791
Crane Interiors	All Upholstery	2 yrs.	Contact WCC
Custom Marine Fabrication	Cabin & Console Tops	Stainless - 5 yrs. Aluminum - 2 yrs.	919/638-2920
Dura-Cast	Fresh Water tank	1 yr.	800/683-4116
Faria Gauges	Gauges	1 yr.	800/473-2742
Florida Marine Tanks	Fuel Tanks	1 yr.	Contact WCC
Inca Molded Products	Baitwell	1 yr.	615/350-7290
Lewmar Marine	Cabin Hatch, Windlass	3 yrs.	203/458-6200
New Century Products	Cabin Windshield	1 yr.	615/822-2001
Rule Industries	Bilge Pumps	5 yrs., pro-rated	978/281-0440
Rule Industries (div.)	Danforth Compass	3 yrs.	978/281-0440
Scandvik	Washdown Faucet & Shower	1 yr.	800/535-6009
ShurFlo	Water Pumps & Cabin Faucet	1 yr.	800/854-3218
Tampco	Bow Rail	1 yr.	910/835-1895
Teleflex	Hydraulic Steering	2 yrs.	604/270-6899
Thetford	Porta-Potti	1 yr.	800/354-4135

Note: Contact the listed vendor for component replacement. Most parts will have the manufacturer's name located somewhere on the part. Please attempt to be certain the vendor that you contact is the supplier of the part required, or see your dealer.

ADVISORY LABELS



WARNING

AVOID SERIOUS OR FATAL INJURY.
DO NOT OCCUPY FORWARD SEATS
WHILE UNDERWAY.

266 sc ONLY
Bow Area Seating



CAUTION

TORQUE ENGINE MOUNTING BOLTS TO 40 FT. LBS.
(4.56Kgm.) ONLY. RE-TORQUE PERIODICALLY,
BUT AT LEAST ANNUALLY.

ALL MODELS
Transom Area
(2 installed)



DANGER

STOP ENGINES BEFORE USE
OF BOARDING LADDER.

ALL MODELS
After Bulkhead



WARNING

Do Not Leave Battery Switch In On Position
When Both Engines Are Running

ALL MODELS
Starboard Battery
Compartment



WARNING

LEAKING FUEL IS A FIRE & EXPLOSION HAZARD.
INSPECT FUEL SYSTEM REGULARLY FOR LEAKS &
CORROSION, BUT AT LEAST ANNUALLY.

ALL MODELS
Starboard Battery
Compartment

CARE, CLEANING & GENERAL INFORMATION

Some simple maintenance tasks performed on a regular basis will keep your *WORLD CAT* in top condition. Even if you are a seasoned skipper, we suggest that you spend a few minutes reviewing the following information. If you have further questions, talk with your dealer for specific recommendations.

GENERAL CARE

The gelcoat surface of your boat is the best available, and is formulated to resist UV degradation for many years. However, accumulated dirt and mineral deposits will cause the finish to lose that "showroom" look more rapidly. Regular washdowns with fresh water and the use of a mild detergent, such as Ivory liquid, will extend that new boat look. In addition, an occasional coat of marine paste wax will further protect all surfaces. Use of harsh chemical or abrasive cleaners is not recommended.

STAINLESS STEEL

Contrary to popular belief, stainless steel is not "stainless." Without proper care, it can rust and discolor gelcoat surfaces (bleeding). Regular washdowns with fresh water and detergent will lessen that possibility. Occasional waxing or wiping down with a product such as Corrosion-X will protect the stainless steel components. NEVER USE STEEL WOOL on rusted areas. It will scratch the protective surface, causing irreparable damage. Avoid the use of any product not specifically designed for use on stainless steel, and check to make certain that other nearby surfaces will not be damaged through such use. For further information, refer to the care pamphlet included with this Manual.

SUNBRELLA

Sunbrella should be cleaned regularly before dirt and mineral deposits become embedded in the fabric. Lightly soiled Sunbrella can be cleaned without removal from the installation. Brush off loose dirt, etc., wet down with fresh water and clean with a mild solution of Ivory liquid and lukewarm water.

For heavily soiled fabric, removal from the frame is necessary. Soak in a solution of 1/2 cup of household bleach and 1/4 cup of Ivory liquid soap per gallon of lukewarm water. Allow the fabric to soak until the bleach has killed any mildew and the stains can be brushed out with a soft bristle kitchen scrub brush. Rinse the fabric repeatedly in cold water to remove soap residue. Allow the fabric to AIR DRY completely before re-installing.

NEVER store any Sunbrella while wet or dirty, or in a moist unventilated area. ALWAYS roll the fabric instead of folding, particularly on side curtains with clear plastic windows. Roll Bimini tops carefully around the collapsed bows and cover with the storage boot.

ZIPPERS & SNAPS

Occasional light lubrication with Corrosion-X will keep these parts operating smoothly. Avoid spraying lubricant on adjacent fabric or acrylic surfaces.

CLEAR ACRYLIC & VINYL WINDOWS & PORTS

Clean with a mild solution of Ivory liquid soap and lukewarm water, using a soft cloth. Use of Pledge furniture polish (NOT lemon-scented) will extend the life of flexible clear vinyl and prevent shrinkage. If scratched, use a product made for clear acrylic scratch removal. Use of automotive products such as Armorall may permanently cloud the surface.

INTERIOR CUSHIONS

Brush and/or vacuum to remove loose dirt. Heavier accumulations may be removed with a mild solution of WOOLite and lukewarm water, applying the foam only with a soft brush. Remove dirt by wiping lightly with a dry cotton towel. Allow thorough AIR DRYING before placing cushions back in the cabin.

Regular washing with a solution of water and Ivory liquid as part of general boat care is recommended. Exterior cushions are closed-cell foam, which will not absorb water. Use a protective product specifically formulated for marine vinyl to provide UV protection. Use of automotive products such as Armorall may deteriorate surfaces and shorten fabric life.

FRESH WATER TANK

Cleaning or deodorizing the fresh water tank may be accomplished by filling the tank with a 5% solution of household bleach and water after draining the contents of the tank. Add approximately 10 gal. water, then add 1 gal. bleach -- fill the remainder of the tank with water. Let stand for several hours. Drain the tank, refill and drain repeatedly until all chlorine odor is removed.

WINTERIZATION/LAY-UP

Refer to the motor manufacturer's manual for storage instructions. Drain all fresh and raw water tanks. Remove batteries and store in a dry cool area (not on a cement surface); maintain charge levels with a trickle-charger. Drain fuel tanks, or fill completely as per local practice or regulation. If full tanks are stored for more than 30 days, it is recommended that a fuel stabilizer be added to prevent degradation. Remove all personal items and portable electronics. Wash the boat thoroughly with a solution of fresh water and Ivory liquid and apply a coat of marine paste wax. If covering, provide some means of ventilation to prevent moisture and/or heat damage.

BOTTOM PAINTING

If your **WORLD CAT** is to be left in the water for extended periods, it is recommended that an application of a high-quality bottom paint be applied to protect against marine growth and deteriorated performance. Follow all manufacturer's precautions regarding the use of personal protective equipment, etc. Hint: To establish the waterline for masking, put the boat in the water for a few days to establish a "scum line" and mask off accordingly. Prepare the hulls by removal of mold release waxes, wiping down the surfaces with a pre-primer solvent; change application and removal rags frequently. Scratch the surfaces lightly with a Scotch-Brite pad to provide a footing for the primer coat. Wipe lightly with solvent once again. Apply an epoxy barrier prime coat(s) per the manufacturer's instructions. Apply the final coat(s) of bottom paint and re-launch per instructions.

LIFTING/DRY-STACK STORAGE

The **WORLD CAT** may be lifted and stored through the use of the (optional) bow lifting eye and the dual transom eyes. Use a spreader bar at the stern to prevent damage to the outboard motors. Slings may also be used, taking care to support at the stern just aft of the fish box and forward at least at the front of the console or the cabin windshield area. Lifting the boat with a forklift may be accomplished through the use of slings, with a supportive lifting platform (see your dealer) or through the center of the tunnel, if the forks can be collapsed sufficiently. Because of the rounded bottom of the hulls and the narrow chines, it is specifically recommended that your dry stack operator **NOT** attempt to lift the **World Cat** from the outside of each hull.

TRANSDUCERS

Transducer mounting is more difficult on a power cat due to the narrow hulls requiring a transom mounting point near the outboards; a possible cavitation problem may result. With the advent of higher power transducers, it is possible to mount them inside the bilge at the bottom, just forward of the bilge pumps, using a product such as epoxy or 3M 5200 sealant -- not silicone (refer to the manufacturer's instructions). For tri-ducer installations (depth, temp, speed), through-hull is best if the boat will not be trailered, again forward of the pumps.

WORLD CAT RIGGING INFORMATION

Note: These are general recommendations for the proper rigging of a World Cat. In all cases, however, the experience of the installation technician regarding safe procedures should prevail.

Motor Mounting Transoms are pre-drilled during production to allow for proper motor mounting. Transom height is 26 1/4", requiring the use of x-long shaft (25") motors. The installation height will be slightly higher than on a conventional monohull to allow cavitation to occur within reasonable limits to provide the best acceleration. Generally, the cavitation plate height is the best reference to determine which bolt hole to use -- the plate should be 3/4" - 1" **above** the bottom (splitting the drain plug hole). Higher installations may require the use of low water pickups to prevent overheating and may also result in premature blow-out of the props; therefore, extreme mounting heights are not recommended. Motor mounting bolts should be torque to 40 ft. lbs. (4.56Kgm) **ONLY**. Re-torque mounting bolts periodically, but at least annually.

Motor Toe It is recommended that the relationship between the two motors' direction of thrust (toe) be set at **zero** to achieve the lightest steering effort and best performance. To adjust toe, refer to the steering adjustment section below.

Steering Adjustment The Sea Star dual cylinder hydraulic steering system features a "liquid tie-bar" to allow both motors to respond to the helm in unison. (Refer to the diagrams in this manual) Occasionally, it will be necessary to realign the motors due to normal use. To align the motors, first center the starboard motor by turning the helm. Then, **open** the system ball valve (located beneath the inspection port on the dive platform) by turning it 90 degrees. This will isolate the port motor from the system and allow it to be moved manually. Center the port motor by hand, then close the ball valve and replace the inspection port cover. Note: It may become necessary to purge ("bleed") the hydraulic system of air from time to time. Refer to the Teleflex steering system bleeding instructions on the next page.

Trim Tabs Setting the trim tabs properly will provide uniform steering effort as the helm is turned to port and starboard. The tabs serve to neutralize the torque effect of the motors on the steering system. For conventional rotation motors, the tab will be set with the trailing edge approximately 3/16" to the **right**. (The adjustment is the same for both motors if both are standard rotation). If a counter-rotation motor is installed on the port side, that tab will be set with the trailing edge approximately 3/16" to the **left**.

Tilt Angle Install the tilt pin slightly out to achieve a neutral (straight up & down) position of the motors relative to the hulls to reduce any bow steering tendency in the mid-speed range. For Yamaha installations (no tilt pins), it is recommended to trim the motors in no further in than 1 bar on the tilt gauges.

Propeller Selection There is a wide variety of OEM and after-market propellers that will provide excellent performance. Your dealer can give customized recommendations based upon your specific requirements. Generally, stainless steel props offer better overall performance than aluminum. Both 3 and 4-blades, full blade area (not semi-cleaver) and cupping perform well on power cats.

Catamaran Bleeding Instructions

Refer to the original system owner's manuals purging instructions and read entire text.

Proceed as follows:

Referencing the cylinder alignment valve installation schematic,

- Fill helm with oil and attach filter device/container to helm.
- Open valve
- Open bleed fitting #1 and pull cylinder shaft all the way on fitting #1 side of cylinder
- Turn steering wheel clockwise until an air free stream of oil comes forth from bleed fitting #1

DO NOT ALLOW SHAFT TO MOVE BACK INTO CYLINDER, HOLD WITH HAND TO STOP IT FROM MOVING.

- Close bleed fitting #1
- Open bleed fitting #2 and pull cylinder shaft all the way out on fitting #2 side of cylinder
- Turn steering wheel counter-clockwise until an air free stream of oil comes forth from bleed fitting #2, then close bleed fitting #2
- Open bleed fitting #3 and pull cylinder shaft all the way out on fitting #3 side of cylinder
- Turn steering wheel counter-clockwise until an air free stream of oil comes forth from bleed fitting #3, then close bleed fitting #3
- Open bleed fitting #4 and pull cylinder shaft all the way out on fitting #4 side of cylinder
- Turn steering wheel counter-clockwise until an air free stream of oil comes forth from bleed fitting #4, then close bleed fitting #4
- Turn steering wheel back and forth from hardover to hardover a couple of times. Align cylinders by pulling cylinder rod all the way out on the same side of each cylinder and close valve.

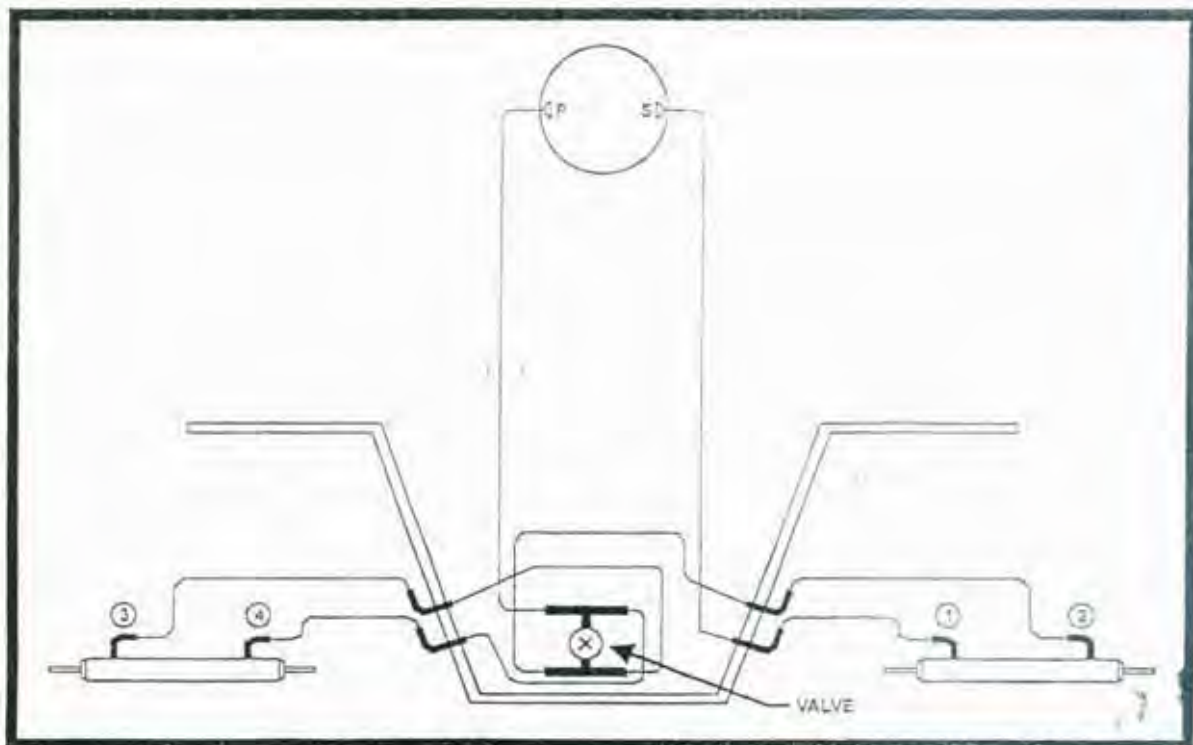

Steering System

Lay - Out & Components - All Models

NOTE: Teleflex requires that all steering system fittings be sealed with **LOCTITE 567** THREAD SEALANT (Part No. 56747). AVOID PLACING SEALANT ON THE FIRST (LEADING) THREAD AS THE SYSTEM CAN BECOME CONTAMINATED LEADING TO STEERING FAILURE. READ INSTRUCTIONS ON TUBE PRIOR TO USE.

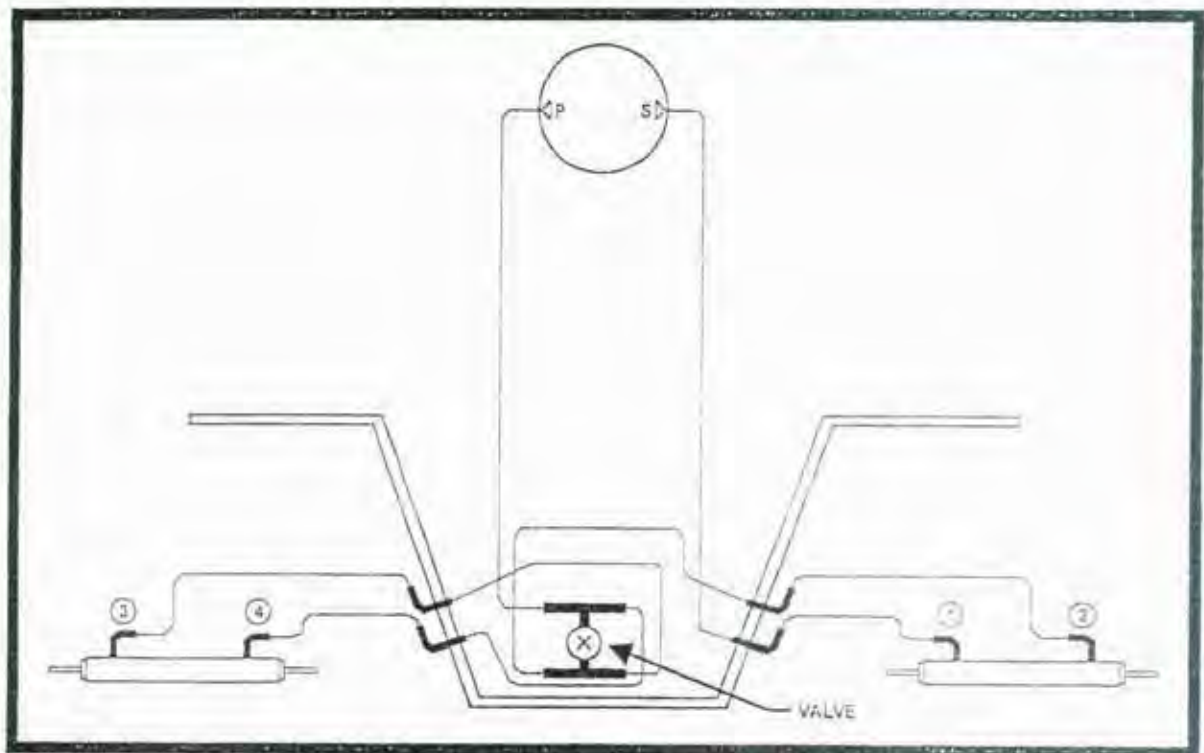

Quantity	Description	Part Number	Application
1	Helm Pump	1.7 Tilt Helm	All Models
2	O/B Cylinders	HC5345	All Models
2	20 ft. Hoses	HO5120	266sc Only
2	18 ft. Hoses	HO5118	246sf & 266sf
2 pair	Bulkhead Fittings	HF5512	All Models
7	3 ft. Hoses	664224	All Models

Fuel System

All Models

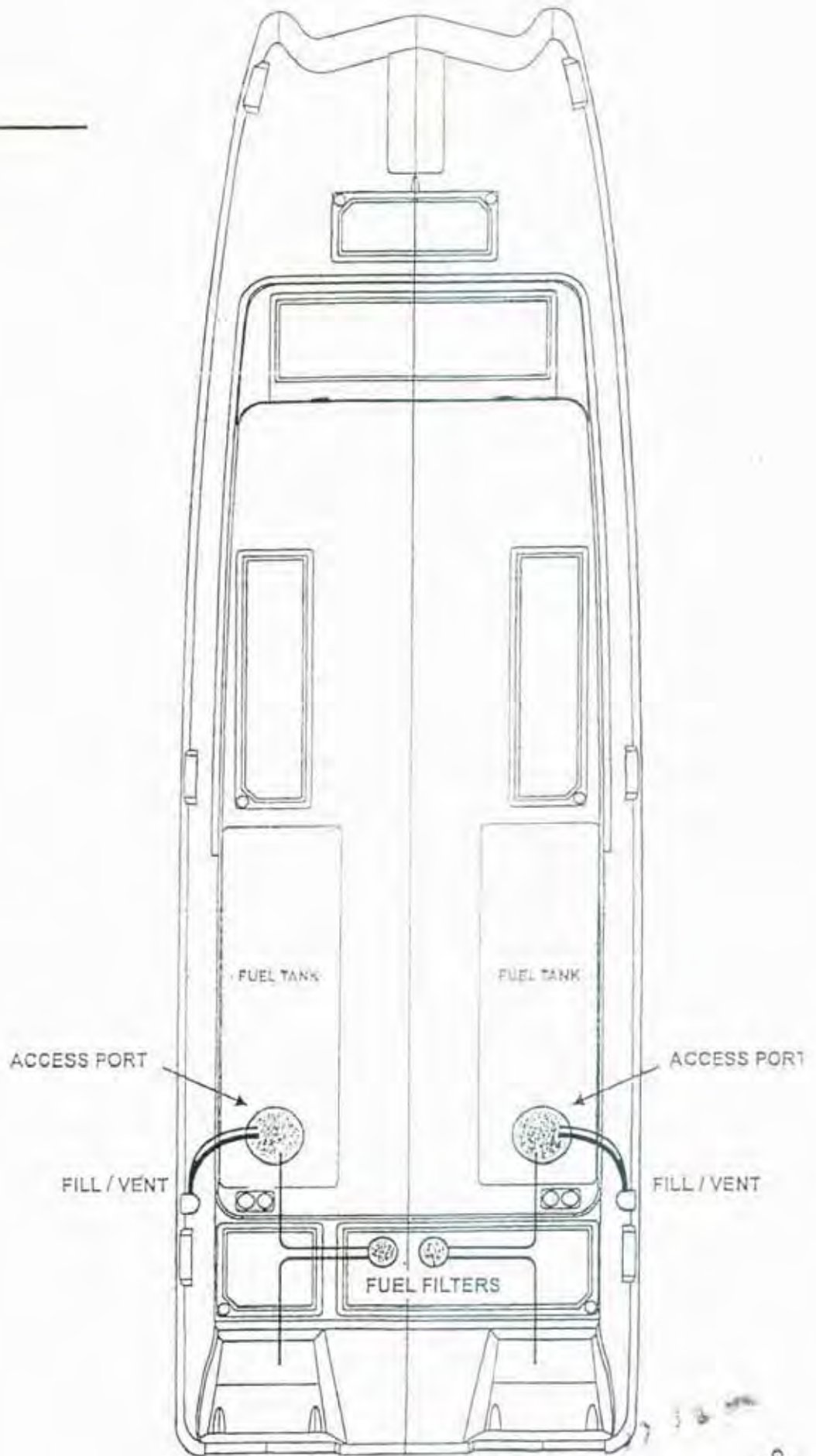

Fresh Water System Center Consoles

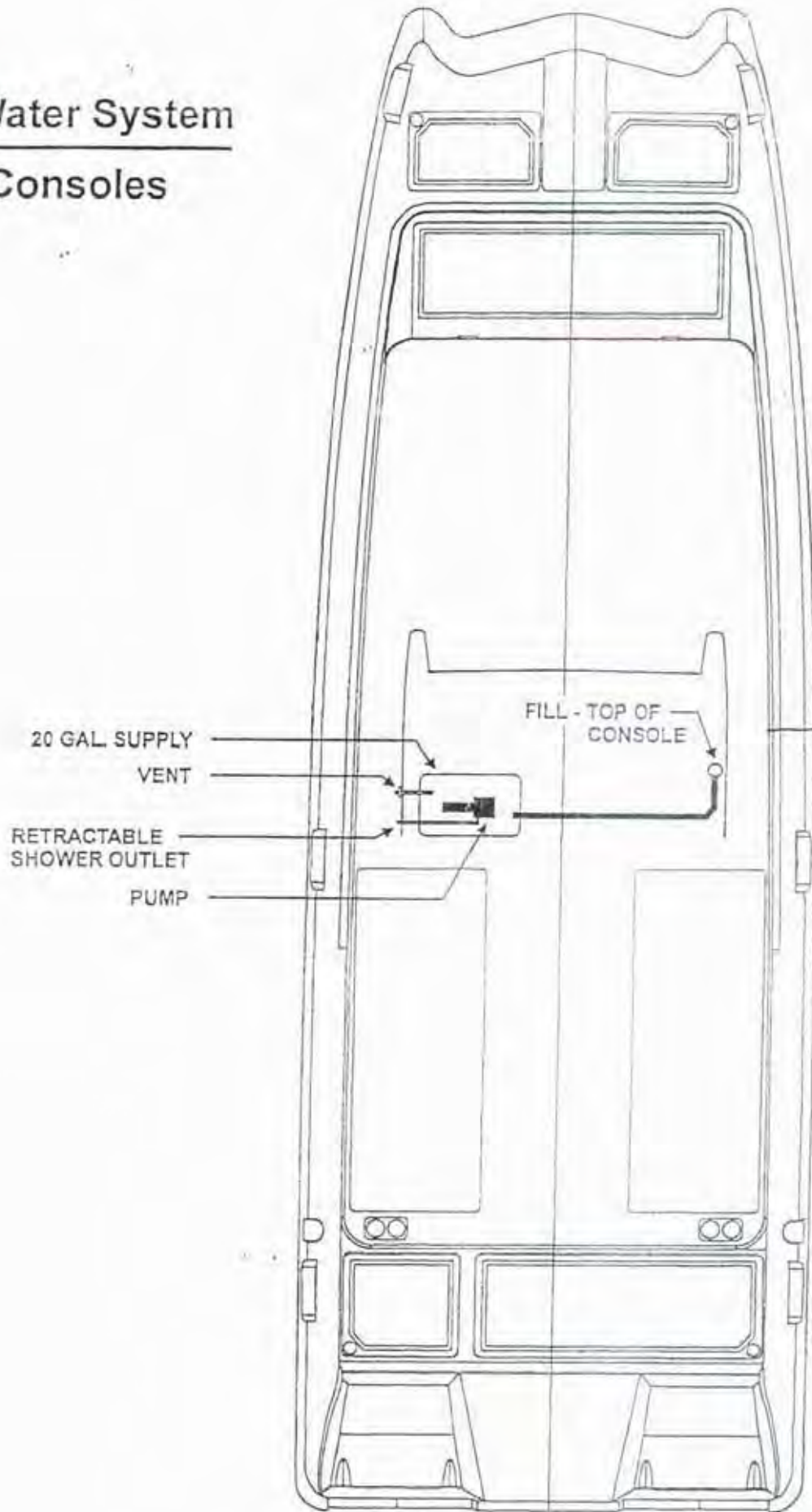

Fresh Water System

Cuddy Cabin

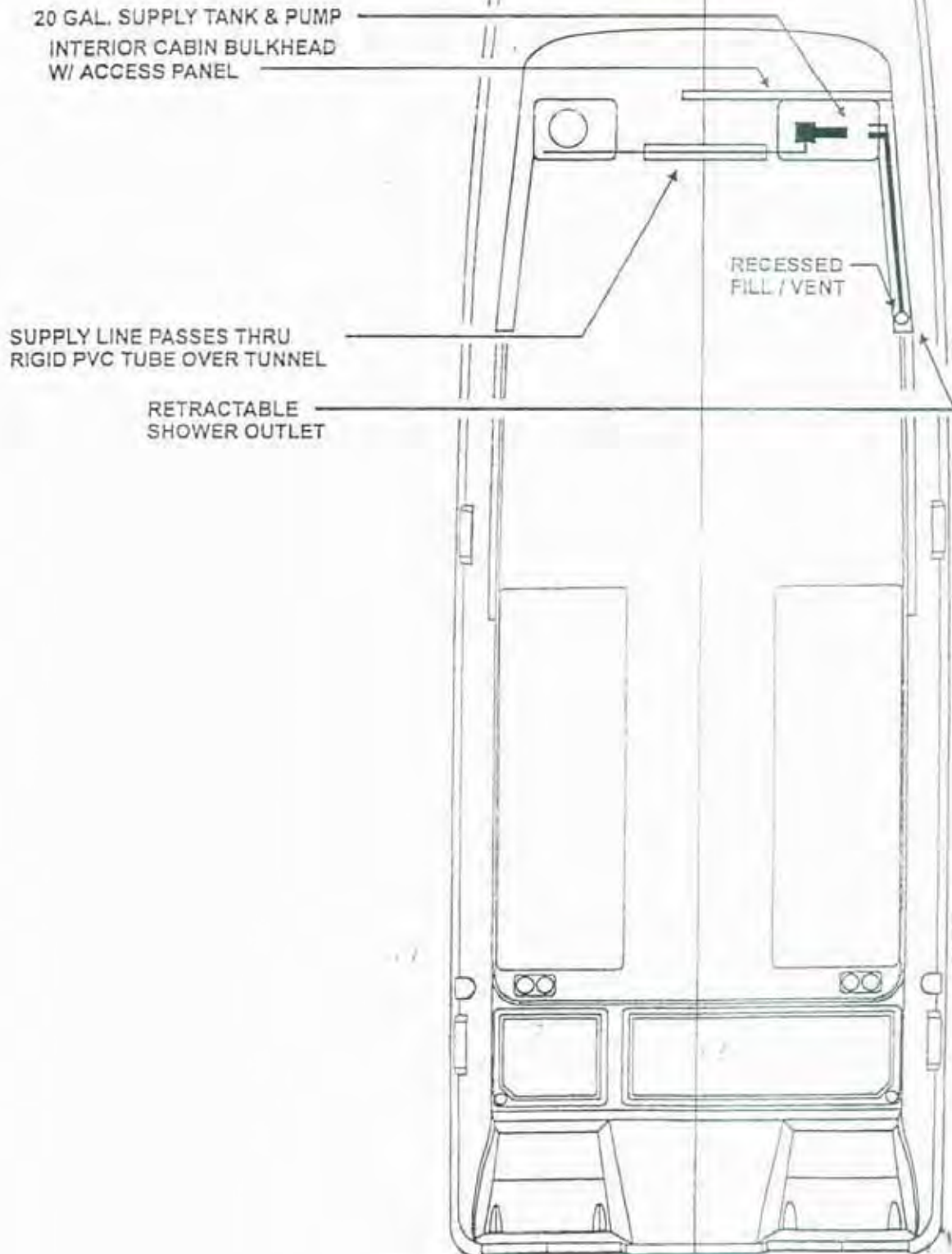

Raw Water System

All Models

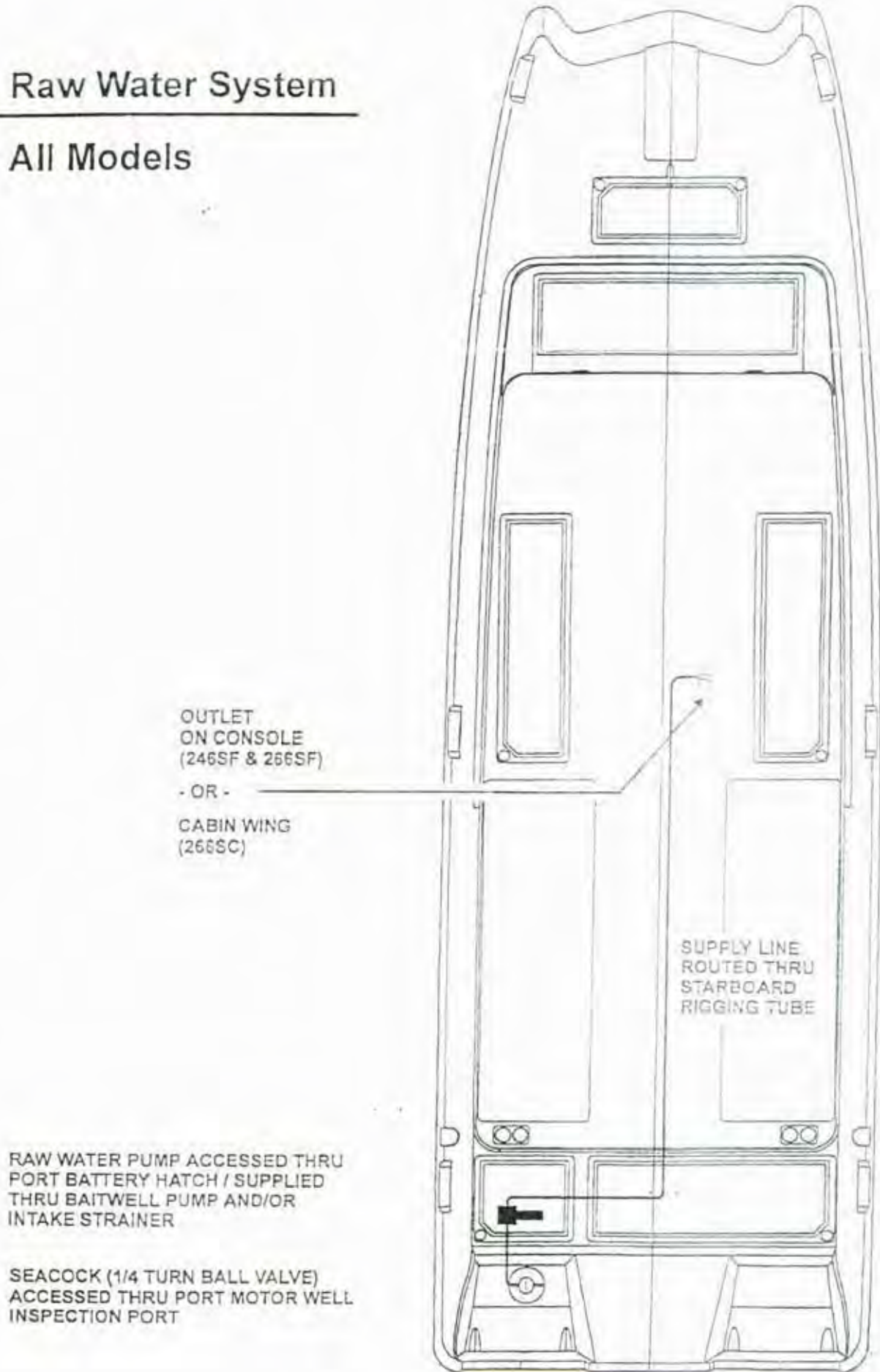

BaitWell System

All Models

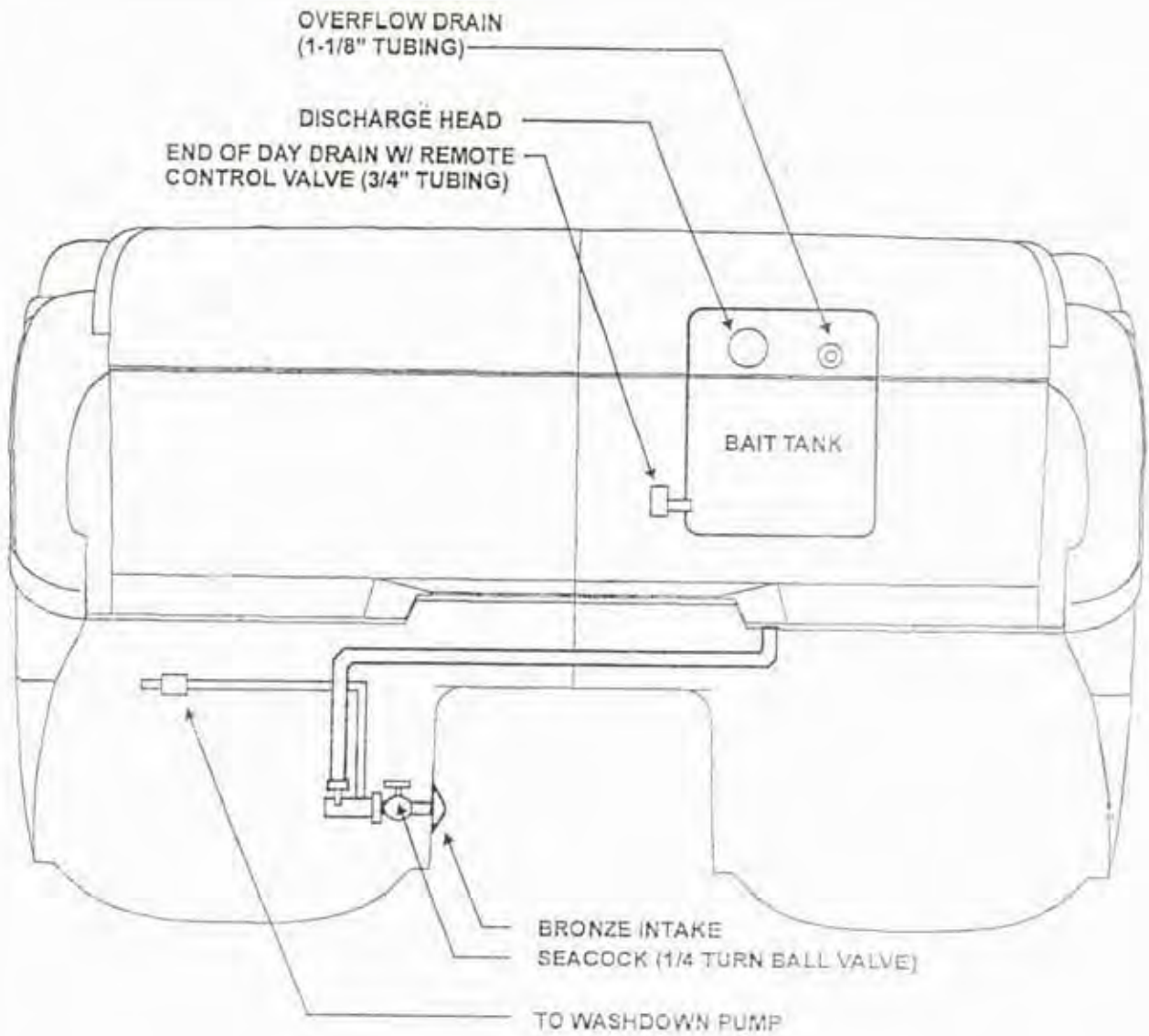

The electrical system for each engine is isolated, except in emergencies when the battery jumper switch may be used to temporarily connect both sides (see below). Main power forward to the helm is provided by the starboard battery through a #6 ga. feed that is protected with a 30A. in-line fuse in the starboard battery/oil injection tank compartment. All accessories are supplied by the starboard battery, including the starboard and port bilge pumps in both manual and automatic modes. **CAUTION:** If additional batteries or battery switching devices are installed, ensure that the automatic side of the bilge pumps (wired independently from the main feed -- see Wiring Code, p.15) remains directly connected to the battery system.

Battery Parallel Switch

The battery jumper switch is located in the starboard battery/oil injection tank compartment. Its purpose is to provide a means of **temporarily** cross-connecting the port and starboard batteries in parallel to provide starting capability for either engine should the individual dedicated battery become discharged. The normal switch position is **OFF** if no cross-connection is necessary to avoid the possibility of diode failure in the alternators. If it becomes necessary to use the jumper switch, turn it to **ON** and start the engine on the discharged side. Turn the switch **OFF** (normal position) and start the other side.

Battery Capacity

Use of a series 27 marine battery as a minimum will be sufficient for all but direct-injection outboards (Ficht/Optimax). Due to the precise voltage and amperage requirements of the ECM modules, these installations require a minimum of 750 cold cranking amps/1000 marine cranking amps. Therefore, a larger series 29 battery is strongly recommended for satisfactory operation. **CAUTION:** The computer control systems of many outboard motors continually draw small amounts of current, even when not running. The batteries may therefore discharge completely if the boat is unused over an extended period (approx. 30 days). In such cases, use of a maintenance trickle charger is recommended, or optionally, disconnecting the batteries completely. Disconnection will not harm the control systems.

Battery Connection Warning

Disconnecting and reconnecting the battery while the engine is running by either removing the battery cable(s) from the battery post(s) will cause an extremely high voltage variation to be produced on the 12 volt line. This voltage will likely cause immediate failure of instruments and any equipment which is operating at the time and may damage the alternators. Less obvious, yet just as destructive are loose, or bad connections between battery cables and battery posts caused by corrosion and/or frayed cables. Also included in this category are defective, cracked, or corroded battery switches and isolators. The possibility of damage is due to the fact that in almost all battery- started engine applications, the battery acts as a voltage limiter. As a preventative measure, battery terminals and clamps should be cleaned and tightened periodically. Cracked, corroded, or otherwise defective battery switches or isolators should be replaced.

WIRING CODE - ALL MODELS

FUNCTION	COLOR	GAUGE	BREAKER/FUSE AMPS	BREAKER/FUSE LOCATION
BATTERY TO BATTERY JUMPER	RED	#4	NONE	N/A
HARNESS MAIN FEED	RED	#6	30A. FUSE	STBD. BATTERY COMPARTMENT
WINDLASS	RED	#6	50A. BREAKER	STBD. BATTERY COMPARTMENT
WASHDOWN PUMP	BROWN	#14	10A. BREAKER	PANEL
BILGE PUMP MANUAL (x 2)	BROWN	#16	5A. FUSE (x 2)	STBD. BATTERY COMPARTMENT
BILGE PUMP AUTO (x 2)	BROWN/WHITE STRIPE	#16	5A. BREAKER (x 2)	PANEL
COCKPIT/INTERIOR LIGHTS	BLUE	#16	5A. BREAKER	PANEL
HORN	ORANGE/WHITE STRIPE	#16	5A. BREAKER	PANEL
WIPER	ORANGE/BLACK STRIPE	#16	5A. BREAKER	PANEL
WIPER PARK	BLACK/WHITE STRIPE	#16	N/A	N/A
NAV. LIGHTING	GREY	#16	5A. BREAKER	PANEL
ANCHOR LIGHT	GREY/WHITE STRIPE	#16	5A. BREAKER	PANEL
BAITWELL PUMP	BROWN	#16	10A. BREAKER	PANEL
FRESH WATER PUMP	BROWN/YELLOW STRIPE	#16	10A. BREAKER	PANEL
ALL GROUNDS	BLACK	#4-6-14-16	N/A	N/A
INSTRUMENT WIRING:				
TACH	GREY	#16	N/A	N/A
VOLTMETER	PURPLE (FROM IGNITION)	#16	N/A	N/A
FUEL SENDER	PINK	#16	N/A	N/A
INST. LIGHTS	BLUE	#16	N/A	N/A
IGNITION	PURPLE	#16	N/A	N/A

NOTE: All factory-installed wiring is tinned copper and conforms to ABYC Yacht specifications.

GAUGE TROUBLESHOOTING QUICK REFERENCE GUIDE

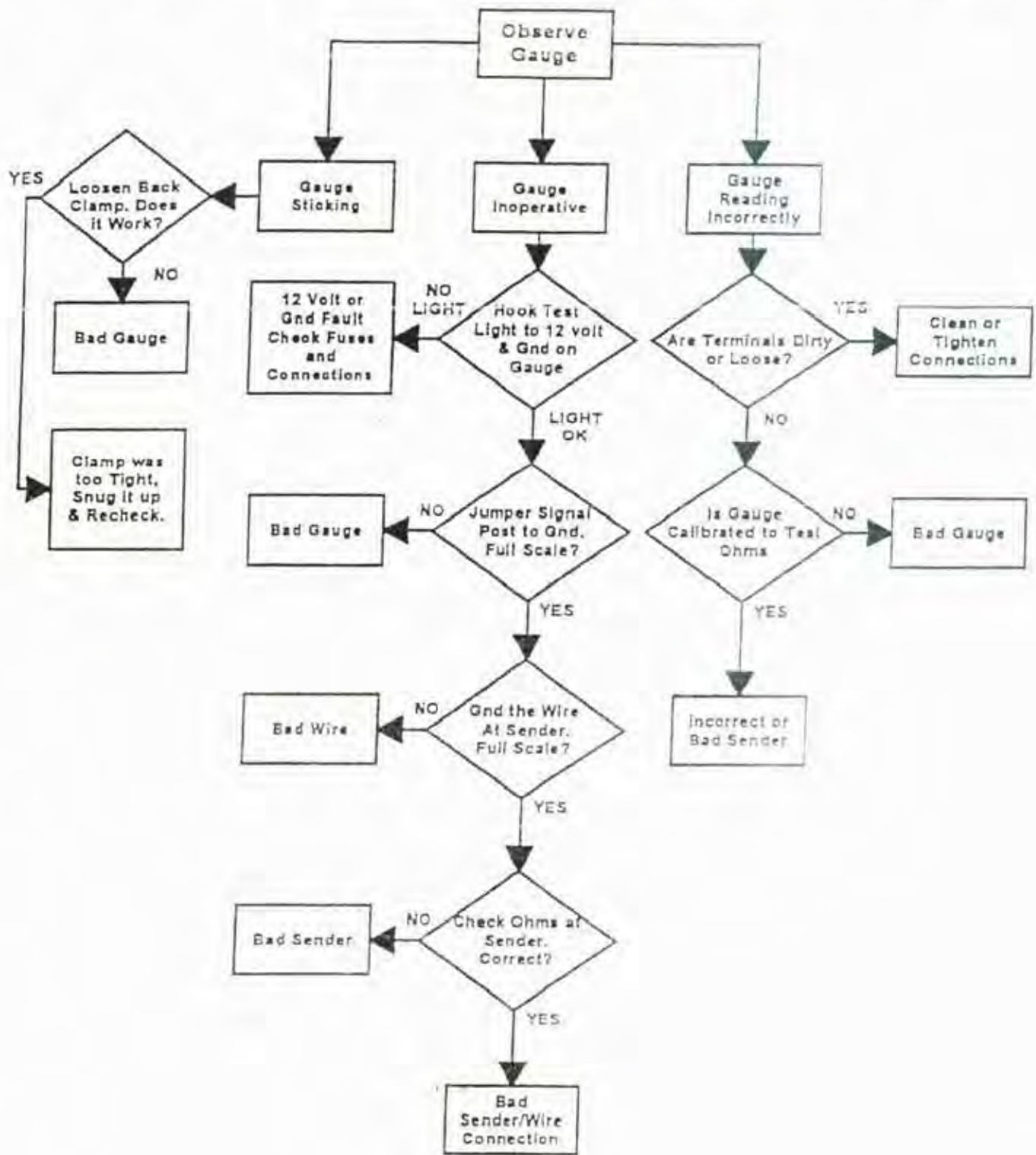

MARINE INSTRUMENTATION -- GENERAL FACTS

Meter Movement Stops

Some marine tachometers have no internal meter stops which therefore permit 360 degrees of pointer movement. When the ignition is shut off, the pointer will fall to approximately to the 6 o'clock position. When the ignition is switched back on, the pointer will go to zero and then to the correct RPM when engine is started.

Other models will stop on zero with no power applied, but have the potential for pegging at the maximum RPM's if the switch on the back of the tach is between positions.

To remedy this, the engine is started and revved up to RPM's higher than mid-range. This will allow the tach to re-synchronize itself and operate normally. The tach can also be shut off, and a magnet used on the face of the lens to return the pointer to zero. Either of these methods can be used (with switch on back of the tach in the correct position) to return to normal operation.

Lens Fogging

Most marine instruments have small vents in their cases to allow a way out for moisture that finds its way in. It is possible for moist air to be drawn into vents when the air inside the tachometer or gauge cools down after the instrument is turned off. The morning sun can draw this moisture up against the lens, causing fogging. This same sun will help force the moisture back out of the instrument as well. Running with the instrument lights "on" can also speed up moisture removal. Fogging is not abnormal, nor will it harm your instruments, which are built to withstand a harsh environment.

Radio Transmissions

Some interference (erratic operation) may be noticed on tachometers during radio transmissions. This will neither damage the instrument nor affect its accuracy when not transmitting.

Operation

Electronic tachometers work by counting pulses generated by the ignition system or alternator. The tach is hooked up to + 12VDC, Ground, and one of the signal sources listed above. By selecting the right tach and setting the switch on the back to the correct position, you let the tachometer know how many pulses are being sent per engine revolution. From this information, the tach displays the correct engine speed. Instrument part numbers are located on a label attached to the outside of the case (i.e. TC0000A).

Application

4 cycle engines: The tach signal terminal is connected to the negative terminal on the ignition coil or to a transistorized tach driver circuit connected to the ignition system. This circuit will have a wire (usually gray) for connection to the tach. The correct tachometer will have a white label on the side indicating which switch position is for each engine type. This label will include 4, 6, and 8 cylinder engines for positions 1, 2, and 3.

2 cycle engines: The tach signal terminal is usually connected to the unrectified AC output of the alternator/lighting coil. Sometimes it is hooked directly to the stator output wire (usually yellow) other times a gray tach output lead is provided. The correct tach for this application will have a white label on the side with switch positions for 4, 6, 8, 10, 12, or 20 pole alternators.

Calibration

Set up a calibrated "shop tach" or "strobe tach" to monitor the engine's true RPM. Start the engine and (after an appropriate warm-up period and with the shift in neutral) increase it's speed to the boat's normal cruising RPM read on the shop tach. Set the coarse adjustment switch to the proper position described on it's label. Remove the stop-plug or paper label corner (at the 8-o'clock position on the rear of the case for most) and insert a 5/16" Allen wrench into the "fine adjustment" trim pot, rotating it CW or CCW as necessary to indicate the true RPM.

Troubleshooting

Symptom recognition is the first step in effective instrumentation troubleshooting. Tachometers usually exhibit the following symptoms:

A) **Dead** - This is usually caused by: 1) No power applied, 2) No signal supplied, or 3) tach damaged by electrical transients caused by disconnecting the battery with the engine running.

1) Check to see if power is applied to tach by switching the instrument supply switch on and off. As power is applied, the pointer should jump slightly. If it does not, check to see that the wires are installed on the correct terminals and that 12 volts are actually applied to the terminals themselves.

2) If tach indicates that power is applied, check for the presence of a signal on the signal terminal. Measure the signal between the signal and ground terminals. This should read in excess of 2 volts DC.

3) If power and signal are present, then it is possible that the tach has been damaged by electrical transients.

B) **Pegged** - This condition occurs on tachs with internal mechanical pointer stops. It is caused by removing power from the tach while it is running in excess of mid-scale RPM's or by the switch on back of the tach being in between positions. When power is re-applied, the tach pointer attempts to go clockwise to zero but cannot because the internal stop is in the way. Read "Marine Instrumentation General Facts" on the previous page for details on how to correct this condition.

C) **Erratic** - This symptom is caused 99% of the time by an intermittent connection between the wire and the ring or spade connector. Often the wire's insulation is pushed into the crimp area and crimped. The center conductor casually touches the connector allowing the tach to work most of the time but causing a nightmare for the technician. Electrical noise also can cause erratic readings. See "Reading High" below for further information.

D) **Reading High** - This is usually caused by the switch on the back of the tach being in the wrong position. If the number of cylinders or alternator poles selected by the switch is too low, the tach will read high. If a variable alternator or magnetic pick-up tach is being used, then further calibration may be necessary, as this calibration is done by the end user. See 'Calibration'. Excessive electrical noise may also cause the tach to read high. These noise spikes are counted by the tach as engine RPM's. The wire affected by the noise can be identified by connecting one wire at a time to the tachometer directly from the battery or the signal source on the engine.

Operation

Gauges operate by sending a low amperage current through the gauge's meter to ground via a sending unit with variable resistance. The resistance of the sending units increase or decrease with the changes in volume. As the sender's resistance varies, the amount of current allowed to flow through it to ground changes and the meter deflects. Instrument part numbers are located on a label attached to the outside of the case (i.e. GA0000A).

Troubleshooting

A) Gauge appears to "stick" during operation - Slightly loosen nuts holding back clamp and check operation. If gauge now operates properly and is not loose in panel, gauge now should provide suitable service. If gauge continues to stick during operation -- replace gauge

B) Gauge is inoperative:

1) To test for voltage to the gauge (use a 12-volt test light or voltmeter for testing):

a) Turn key switch to ON position. Connect the test light or voltmeter lead to the ignition "I" terminal of the gauge and the other lead to the ground "G" or "GND" terminal of the gauge. If test light lights or approximately 12 volts is indicated on the test meter, the ignition and ground connections are good.

b) If test light does not light or there is no reading on the test voltmeter, check the positive 12 volt power source at the key switch or fuse block. If no power is available at those points, correct the lead problem or replace any blown fuses.

c) If test light still does not light or voltmeter still shows no voltage, check ground wire and connections by connecting one lead of test light or voltmeter to a known source of B(+) and the other lead to the ground terminal of the gauge. If lamp lights or voltage is indicated on the voltmeter while touching the ground terminal of the gauge, the ground connection to the gauge is good. If lamp does not light or voltmeter does not show voltage, check ground connection to gauge and connection to ground source.

2) To test gauge operation and sending unit connections:

a) Turn key switch to OFF position. Connect a jumper lead between the "S" terminal and the "G" or "GND" terminal of the gauge. Turn key switch to ON position. If the gauge registers a full scale reading under those conditions, the gauge is good. If less than full scale reading is indicated, the gauge is defective and should be replaced.

b) If no reading is indicated, remove sending unit lead wire from sending unit on the engine. Turn the key switch to the "ON" position. Ground the sending unit lead wire to a good ground and note the gauge reading. If the gauge registers a full scale reading the sending unit may be defective.

c) Remove jumper lead. Remove sending unit lead wire from the sending unit on the fuel tank. Turn key switch to ON position. Ground the sending unit lead wire to a good ground and note the gauge reading. If the gauge now (after grounding the sending unit lead wire) registers a full scale reading, the sending unit is defective and should be replaced. NOTE: Intermittent readings usually indicate loose connections or shorted wiring. Check all connections and wiring if the above checks do not pinpoint a specific defect.

C. Sending Unit is defective - Disconnect sending unit lead from gauge "sender" terminal. Using ohmmeter, test sending unit resistance. If sending unit shows EITHER zero ohms or open circuit, check sending unit or wiring for defects.

Operation

A voltmeter indicates the battery voltage and the general condition of the battery charging system. The meter requires no warm-up and indicates voltage changes instantly. Instrument part numbers are located on a label attached to the outside of the case (i.e. VP0000A).

Troubleshooting

A) Gauge appears to "stick" during operation - Slightly loosen nuts holding back clamp and check operation. If gauge now operates properly and is not loose in panel, gauge now should provide suitable service. If gauge continues to stick during operation, replace gauge.

B) No voltage reading is noted on the voltmeter:

1) If the indications are normal (engine starts, lamps lights, etc.) proceed with this test, otherwise, check battery voltage with a test voltmeter, or a 12 volt test light.

2) Check for voltage at voltmeter by connecting test voltmeter or 12 volt test light to "+" and "-" terminals of voltmeter; turn ignition switch on.

a) If light does not light, or if test voltmeter reads the same as installed voltmeter, the problem is in the battery charging system or wiring. Refer to the outboard motor manufacturer's shop manual for trouble-shooting procedure.

b) If test voltmeter indicates correct voltage; typically 14 volts with engine running and at least 12 volts with no accessories on and engine off (see outboard motor shop manual for details), then replace voltmeter.

WATER PRESSURE GAUGES

Operation

Gauges indicate cooling system pressure and proper operation of water pumps and thermostats. A sudden drop in pressure indicates that a foreign object (plastic bag, seaweed) is obstructing the water intakes. The gauges are directly supplied by tubing connected to each outboard -- No sending unit is utilized. Instrument part numbers are located on a label attached to the outside of the case (i.e. WP0000A).

Troubleshooting

A) Gauge appears to "stick" during operation - Slightly loosen nuts holding back clamp and check operation. If gauge now operates properly and is not loose in panel, gauge now should provide suitable service. If gauge continues to stick during operation -- replace gauge.

B) Gauge is inoperative - Remove tubing from affected gauge. Start outboard and check for water flow at the gauge end of the tubing (This may take a few seconds). If there is no water flow, check for proper water pump and thermostat operation, a loose tubing connection at the outboard or a kink in the tubing line. If all of these are normal -- replace gauge.

THIS DRAWING IS THE PROPERTY OF ATLANTIC MARINE PRODUCTS, INC. ANY INFORMATION, SPECS OR DESIGNS MAY NOT BE COPIED OR USED IN ANY WAY WITHOUT THE WRITTEN PERMISSION OF ATLANTIC MARINE PRODUCTS, INC. AND IT MUST BE RETURNED UPON REQUEST

REVISIONS				
ZONE	REV	DESCRIPTION	DATE	APPROVED

NAV-ANC SWITCH DETAILS

WIPER SWITCH DETAILS

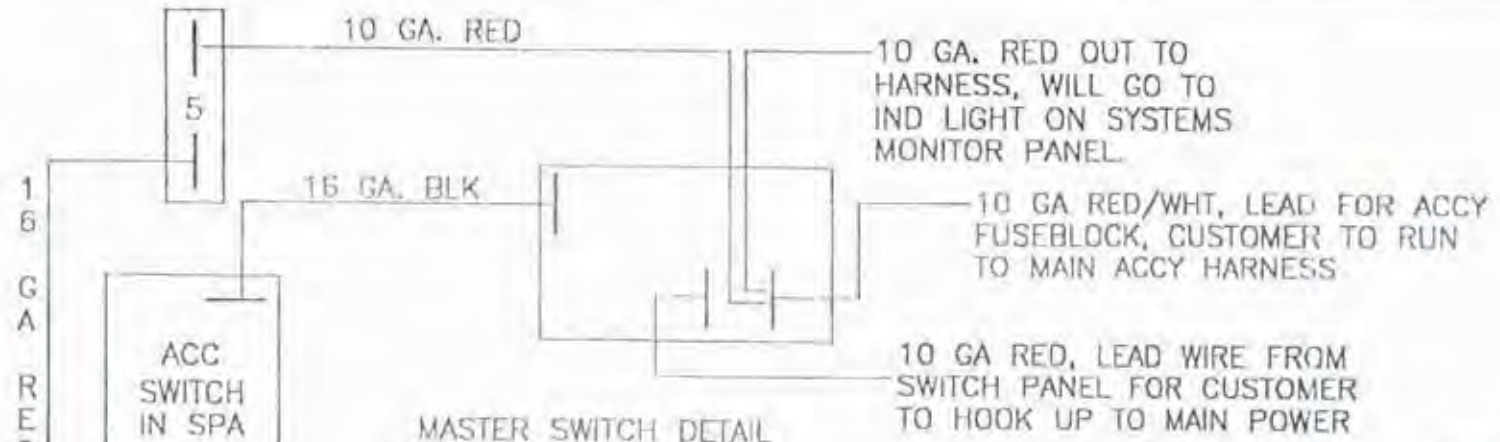
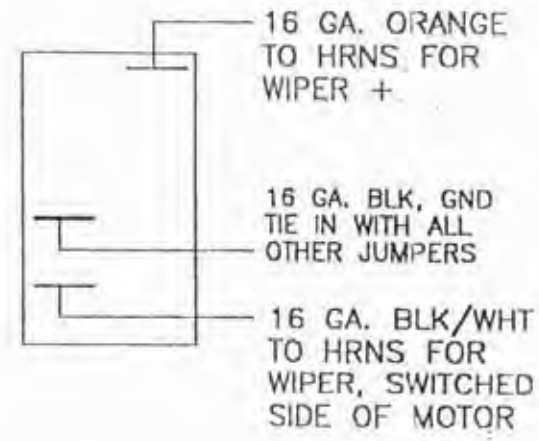
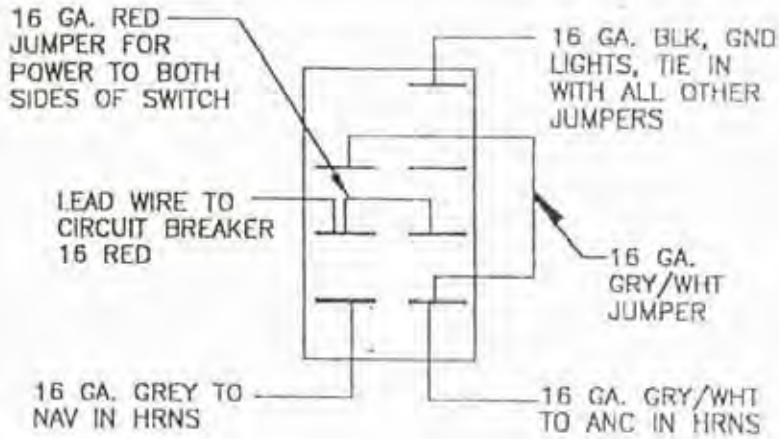

MASTER SWITCH DETAIL

DETAILS OF SWITCH WIRING

MACHINE & FABRICATION NOTES
 ALL DIMS ARE +/- .010 & ANGLES ARE +/- 1'
 UNLESS NOTED OTHERWISE
 FINISHED EDGES ARE INDICATED BY FINISH MARK ✓
 PERIMETER EDGES ARE TO BE FINISHED, BREAK ALL SHARP EDGES AND CORNERS. PARTS ARE TO BE

ATLANTIC MARINE PRODUCTS, INC			
DRN BY: GMM	WORLD CLASS CATAMARAN		
CHK BY: GMM	25 CABIN SWITCH PNL		
SHEET 1 OF 1	DATE DRAWN: 7AUG97	DWG NO.: NTS NAF001	REVISION: 0

8 7 6 5 4 3 2 1

THIS DRAWING IS THE PROPERTY OF ATLANTIC MARINE PRODUCTS, INC. ANY INFORMATION, SPECS OR DESIGNS MAY NOT BE COPIED OR USED IN ANY WAY WITHOUT THE WRITTEN PERMISSION OF ATLANTIC MARINE PRODUCTS, INC. AND IT MUST BE RETURNED UPON REQUEST

ZONE		REV	REVISIONS	DATE	APPROVED
			DESCRIPTION		

WIPER SWITCH DETAILS

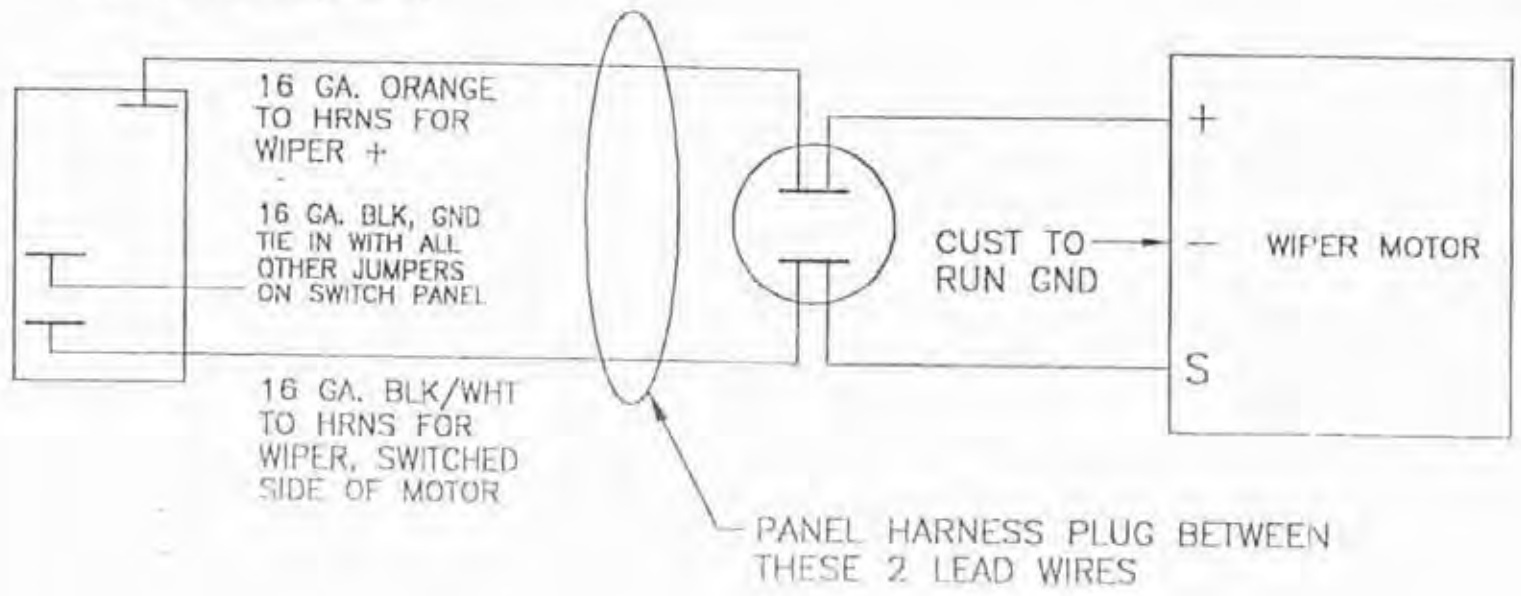

DETAILS OF SWITCH WIRING

<p>MACHINE & FABRICATION NOTES</p> <p>ALL DIMS ARE +/- .010 & ANGLES ARE +/- 1° UNLESS NOTED OTHERWISE</p> <p>FINISHED EDGES ARE INDICATED BY FINISH MARK \surd</p> <p>PERIMETER EDGES ARE TO BE FINISHED, BREAK ALL SHARP EDGES AND CORNERS. PARTS ARE TO BE CLEAR AND FREE OF DEBRIS</p>		<p>ATLANTIC MARINE PRODUCTS, INC</p> <p>DRN BY: GMM</p> <p>CHK BY: GMM</p> <p>SHEET 1 OF 2</p> <p>DATE DRAWN: 7AUG97</p>		<p>WORLD CLASS CATANARAN 25 CABIN SWITCH PNL</p> <p>DWG NO. NTS NAF001</p> <p>REVISION 0</p>	
---	--	---	--	---	--

8 7 6 5 4 3 2 1

THIS DRAWING IS THE PROPERTY OF ATLANTIC MARINE PRODUCTS, INC. ANY INFORMATION, SPECS OR DESIGNS MAY NOT BE COPIED OR USED IN ANY WAY WITHOUT THE WRITTEN PERMISSION OF ATLANTIC MARINE PRODUCTS, INC. AND IT MUST BE RETURNED UPON REQUEST

REVISIONS				
ZONE	REV	DESCRIPTION	DATE	APPROVED

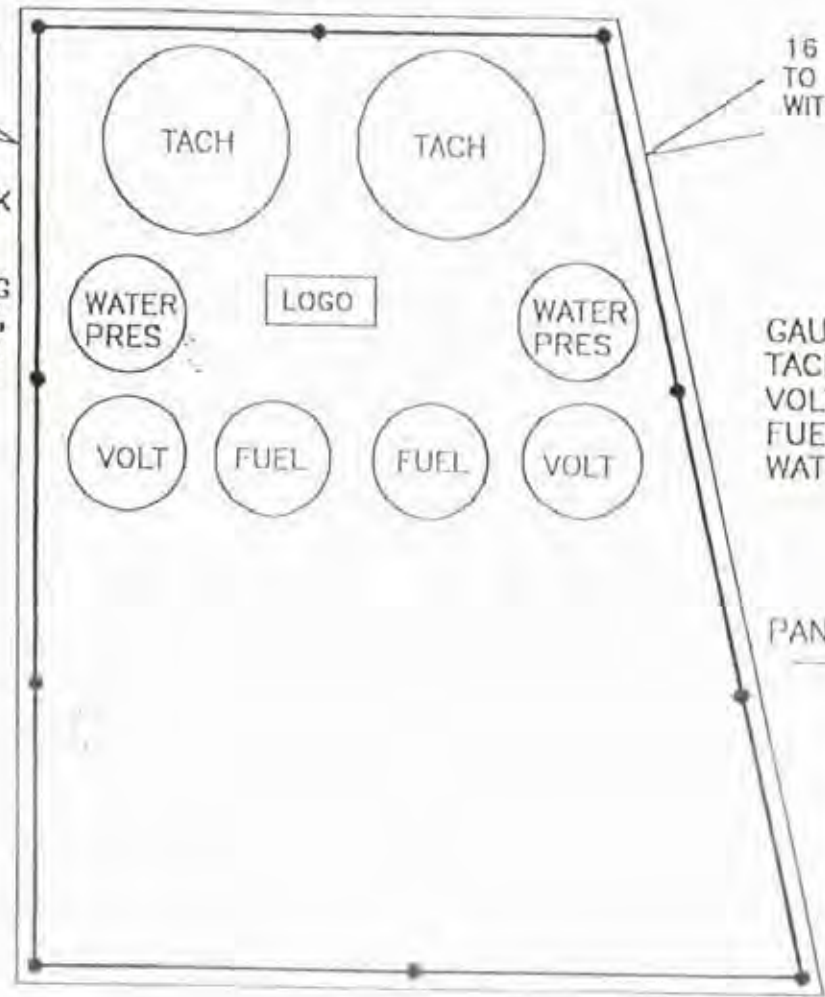

16 GA PURPLE & 16 GA BLACK LEADS FOR CUSTOMER TO HOOK UP, HANG OFF PANEL 12", TAPE TOGETHER WITH RED TAPE FOR PORT DESIGNATION

16 GA PURPLE AND 16 GA BLACK LEADS FOR CUSTOMER TO HOOK UP, HANG OFF PANEL 12", TAPE 2 TOGETHER WITH GREEN TAPE FOR STBD DESIGNATION

ASSEMBLY PARTS

- GAUGES ARE FARIA CHESAPEAKE WHITE SS SERIES
- TACH 7K = TC9863/XI01900 (2 REQ'D)
- VOLTMETER = VP9158/XY02400 (2 REQ'D)
- FUEL = GP9373/XY02400 (2 REQ'D)
- WATER PRES. 30PSI = OP1022/XU06900 (2 REQ'D)
- WATER PRESSURE KIT SHIPS WITH EVERY PANEL ASSEMBLY, INCLUDED WITH GAUGE. (2 REQ'D)
- PANEL, MACHINED & SCREENED, NAF004 (1 REQ'D)

NOTES

BASIC PREWIRE FOR ALL THE GAUGES WITH LEADS FOR THE PURPLE (IGN), BLACK (GND), BLUE (LIGHTS), RUN PORT AND STBD SIDE SEPERATELY. SEE WIRING DIAGRAM

FINAL ASSEMBLY PART NUMBER 09-0006

MACHINE & FABRICATION NOTES		ATLANTIC MARINE PRODUCTS, INC	
ALL DIMS ARE +/- .010 & ANGLES ARE +/- 1° UNLESS NOTED OTHERWISE		DRN BY: GMM	
FINISHED EDGES ARE INDICATED BY FINISH MARK ✓		CHK BY: GMM	
PERIMETER EDGES ARE TO BE FINISHED, BREAK ALL SHARP EDGES AND CORNERS. PARTS ARE TO BE		NORTH AMER. FIBERGLASS	
		CEN. CON. INST PHL.	
		DATE DRAWN 17JUN87	
		SCALE 1:1	
		PART NO. NAF004	
		REV. 0	

THIS DRAWING IS THE PROPERTY OF ATLANTIC MARINE PRODUCTS, INC. ANY INFORMATION, SPECS OR DESIGNS MAY NOT BE COPIED OR USED IN ANY WAY WITHOUT THE WRITTEN PERMISSION OF ATLANTIC MARINE PRODUCTS, INC. AND IT MUST BE RETURNED UPON REQUEST

REVISIONS				
ZONE	REV	DESCRIPTION	DATE	APPROVED

HORN NAV/ANC COCKPIT PORT STBD LIVEWELL RAW ACC-1 ACC-2 ACC-3 ACC-4 MASTER
 LIGHTS LIGHTS BILGE BILGE PUMP WATER

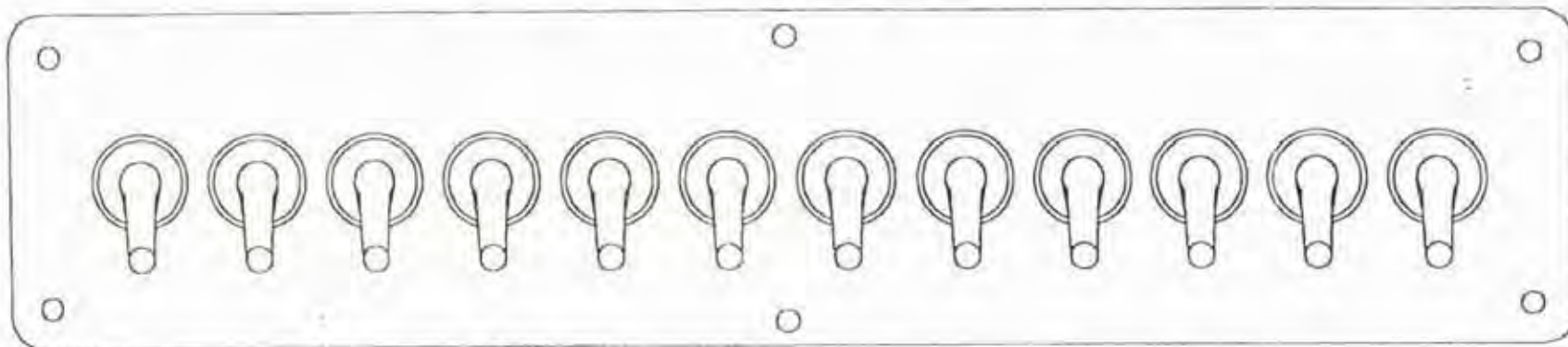

ASSEMBLY PARTS

- CARLING CHROME BAT TOGGLE SWITCHES, NON LIT SERIES
 - NAV-ANC DPDT ON-OFF-ON 2GM51-78 (1 REQ'D)
 - HORN SPST OFF-MOM 6GA5B-78 (1 REQ'D)
 - ALL OTHERS SPST OFF-ON 2CA51-78 (10 REQ'D)
- BLACK BOOTS FOR SWITCHES C1131/35-20-BLACK (12 REQ'D)
- PANEL HARNESSSES, 8 WAY & 4 WAY MOLDED
 - NAFSHR-C (1 REQ'D) NAFSHR-D (1 REQ'D)
 - SEE SAMPLE FOR EXACT PLACEMENT
- PANEL, MACHINED, NO SCREENING, NAF-002 (1 REQ'D)

FINAL ASSEMBLY PART NUMBER 09-0004
 THIS PANEL IS PART OF THE FINAL ASSEMBLY NUMBER. SEE CIRCUIT BREAKER PANEL AND FULL ASSY DRAWING FOR ALL OTHER INFO

NOTES

- JUMPERS AND PREWIRE SHOULD BE TAKEN FROM CUTSHEETS AND PLACED PER SAMPLE.
- SEE SEPERATE DRAWING FOR THE WIRING OF THE NAV-ANC, AND FOR ALL OTHER WIRING, ALSO SEE SAMPLE.
- SEE WIRING DIAGRAM FOR PROPER PLACEMENT OF ALL WIRES FROM THE HARNESSSES.
- DROP OFF LENGTHS CAN BE FOUND ON THE FINAL ASSEMBLY DRAWING THAT INCLUDES THE CIRCUIT BREAKER PANEL THAT IS PART OF THE FINAL ASSEMBLY.

MACHINE & FABRICATION NOTES
 ALL DIMS ARE +/- .010 & ANGLES ARE +/- 1°
 UNLESS NOTED OTHERWISE
 FINISHED EDGES ARE INDICATED BY FINISH MARK ✓
 PERIMETER EDGES ARE TO BE FINISHED. BREAK ALL SHARP EDGES AND CORNERS. PARTS ARE TO BE

ATLANTIC MARINE PRODUCTS, INC
 DRN BY: GMM
 CHK BY: GMM
 SHEET 1 OF 1
 DATE DRAWN: 12 AUG 97
 SCALE: 1:1
 DWG NO.: CC SW/BKR SHROUD ASSY
 REVISION: 0
 SYCBASSY

8 7 6 5 4 3 2 1

THIS DRAWING IS THE PROPERTY OF ATLANTIC MARINE PRODUCTS, INC ANY INFORMATION, SPECS OR DESIGNS MAY NOT BE COPIED OR USED IN ANY WAY WITHOUT THE WRITTEN PERMISSION OF ATLANTIC MARINE PRODUCTS, INC. AND IT MUST BE RETURNED UPON REQUEST

REVISIONS				
ZONE	REV	DESCRIPTION	DATE	APPROVED

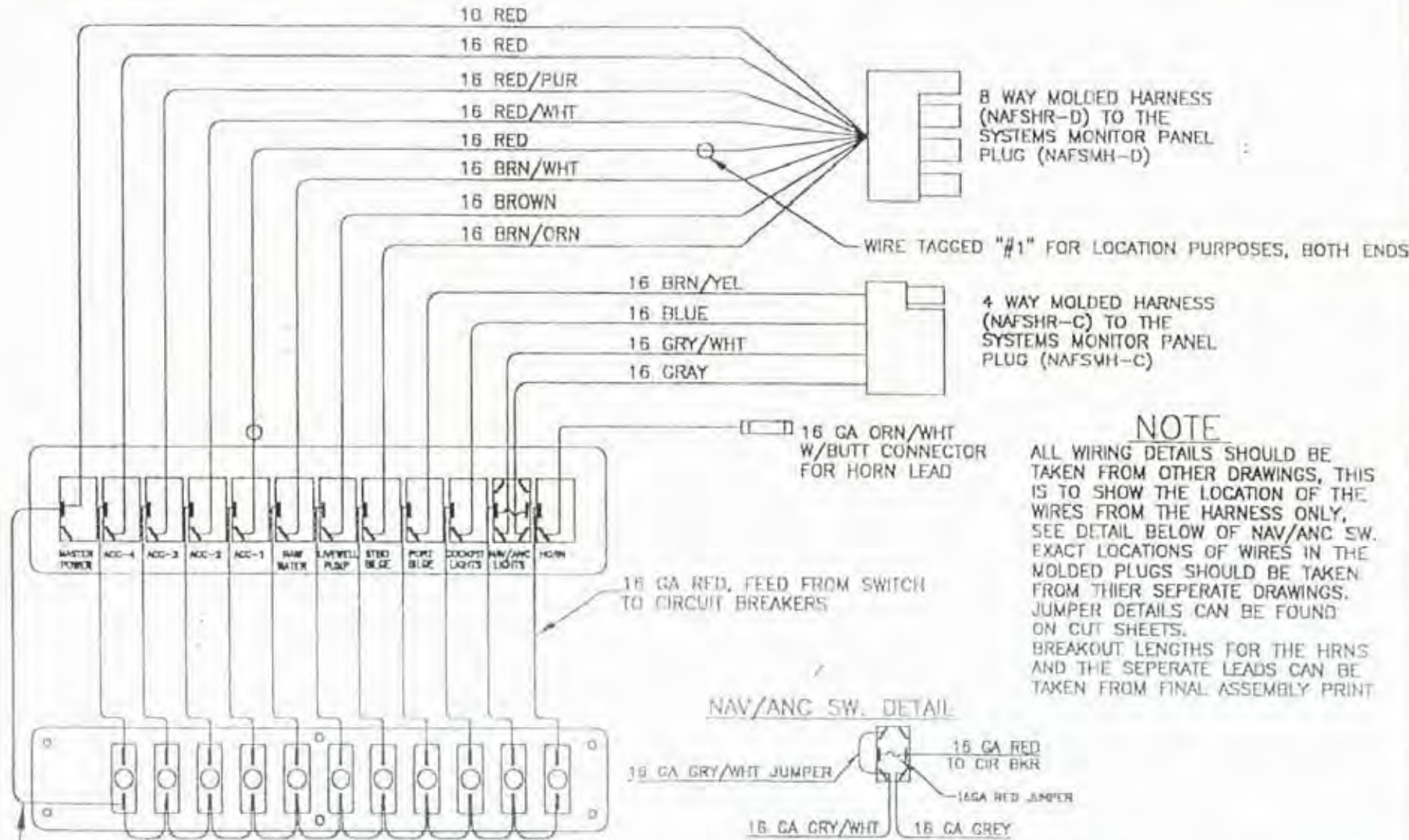

FINAL WIRING ASSEMBLY 09-0004

MACHINE & FABRICATION NOTES ALL DIMS ARE +/- .010 & ANGLES ARE +/- 1° UNLESS NOTED OTHERWISE. FINISHED EDGES ARE INDICATED BY FINISH MARK PERIMETER EDGES ARE TO BE FINISHED, BREAK ALL SHARP EDGES AND CORNERS, PARTS ARE TO BE CLEAR AND FREE OF DEBRIS.		ATLANTIC MARINE PRODUCTS, INC DRN BY: GMM CHK BY: GMM SHEET 1 OF 2 DATE DRAWN: 12 AUG 97 SCALE: 1:1 DWG NO.: SW/BKR SHROUD ASSY REVISED BY: SWCBASSY REVISION: 0	
--	--	--	--

THIS DRAWING IS THE PROPERTY OF ATLANTIC MARINE PRODUCTS, INC. ANY INFORMATION, SPECS OR DESIGNS MAY NOT BE COPIED OR USED IN ANY WAY WITHOUT THE WRITTEN PERMISSION OF ATLANTIC MARINE PRODUCTS, INC. AND IT MUST BE RETURNED UPON REQUEST

ZONE REV		REVISIONS	DATE	APPROVED
		DESCRIPTION		

8 WAY MOLDED ACCY HRNS NAFSMH-D



6"

4 WAY MOLDED ACCY HRNS NAFSMH-C



6"

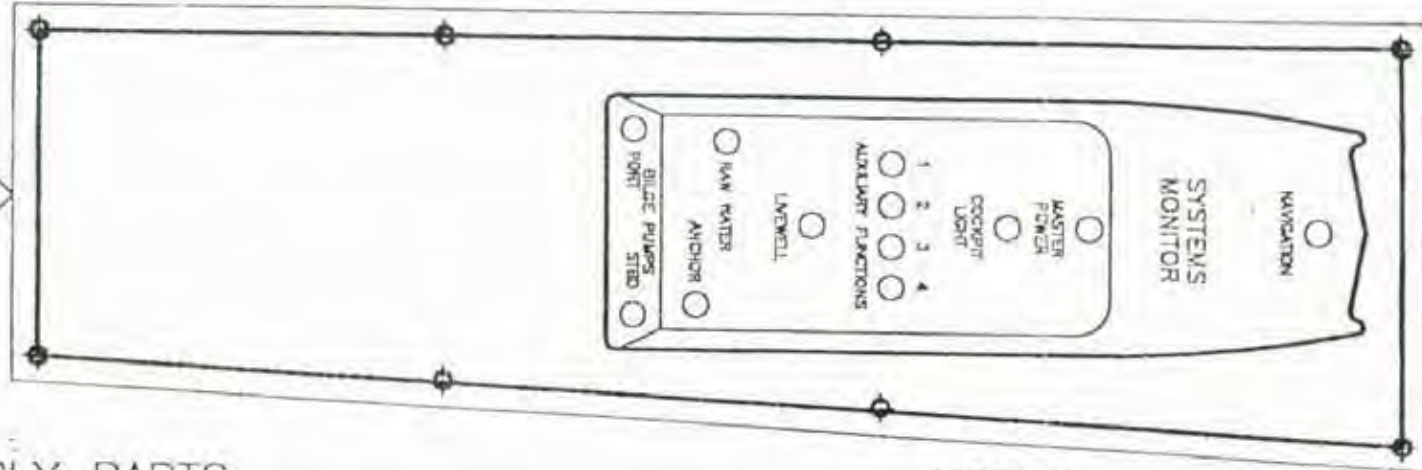

ASSEMBLY PARTS:

- ALL LIGHTS ARE SOLICO 14V LED LIGHTS
- "MASTER", 6401-14/BL BASE, RED LED, (1 REQ'D)
- ALL OTHERS, 6404-14/BL BASE, GREEN LED, (11 REQ'D)
- LIGHTS ARE MOUNTED USING TINNEMAN CLIPS, CLIPS ARE APPLIED FROM BACK OF LIGHT, SEE SAMPLE.
- 3SCLIP, (12 REQ'D)
- HARNESS TO SWITCH PANEL, NAFSMH-C (1 REQ'D)
- HARNESS TO SWITCH PANEL, NAFSMH-D (1 REQ'D)
- PANEL, MACHINED & SCREENED, NAF007 (1 REQ'D)

NOTES:

- ALL LIGHTS ARE GROUND TO LEAD GROUND THAT CUSTOMER WILL WIRE INTO GROUND BLOCK
- LEAD FROM ONE SIDE OF THE LIGHT GOES TO THE SWITCH PANEL, LINE SIDE OF SWITCHES, THERE WILL BE A PIGGY BACK TERMINAL ON THAT SIDE OF THE LIGHT FOR THE CUSTOMER TO HOOK UP WIRE FROM ACCESSORY HRNS.
- SEE SAMPLE FOR WIRE PLACEMENT AND ROUTING OF HARNESSES TO SWITCH PANEL.
- BACKSIDE OF PANEL IS SCREENED WITH THE FUNCTIONS FOR CUSTOMER REF WHEN ATTACHING THE MAIN HARNESS TO THE LIGHTS.
- SEE WIRING DIAGRAM FOR PROPER PLACEMENT OF ALL WIRES
- JUMPERS SHOULD BE TAKEN FROM CUTSHEET AND BE PLACED PER SAMPLE

(GND, 16 BLK)

(GND, 16 BLK)

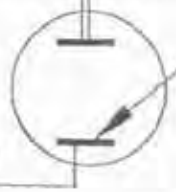

CUSTOMER TO LAND ALL WIRES IN BOAT TO THIS TERMINAL. ALL OTHER WIRES ARE PRERIGGED.

FUNCTION WIRE TO HARNESS TO SWITCH PANEL.

NOTE: FUNCTION WIRE ATTACHES TO THE + SIDE OF THE LIGHT, IT IS MARKED WITH A RED INK SPOT

FINAL ASSEMBLY PART NUMBER 09-0005

MACHINE & FABRICATION NOTES
 ALL DIMS ARE +/- .010 & ANGLES ARE +/- 1'
 UNLESS NOTED OTHERWISE
 FINISHED EDGES ARE INDICATED BY FINISH MARK
 BREAK ALL SHARP EDGES AND CORNERS, PARTS ARE TO BE CLEAR AND FREE OF DEBRIS.

ATLANTIC MARINE PRODUCTS, INC
 DRN BY: GMM
 CHK BY: GMM
 SHEET 1 OF X
 DATE DRAWN: 14AUG97
 SCALE: 1:1
 PNC NO.: NAF007
 REVISION: 0

8	7	6	5	4	3	2	1
THIS DRAWING IS THE PROPERTY OF ATLANTIC MARINE PRODUCTS, INC. ANY INFORMATION, SPECS OR DESIGNS MAY NOT BE COPIED OR USED IN ANY WAY WITHOUT THE WRITTEN PERMISSION OF ATLANTIC MARINE PRODUCTS, INC. AND IT MUST BE RETURNED UPON REQUEST					REVISIONS ZONE REV DESCRIPTION DATE APPROVED		

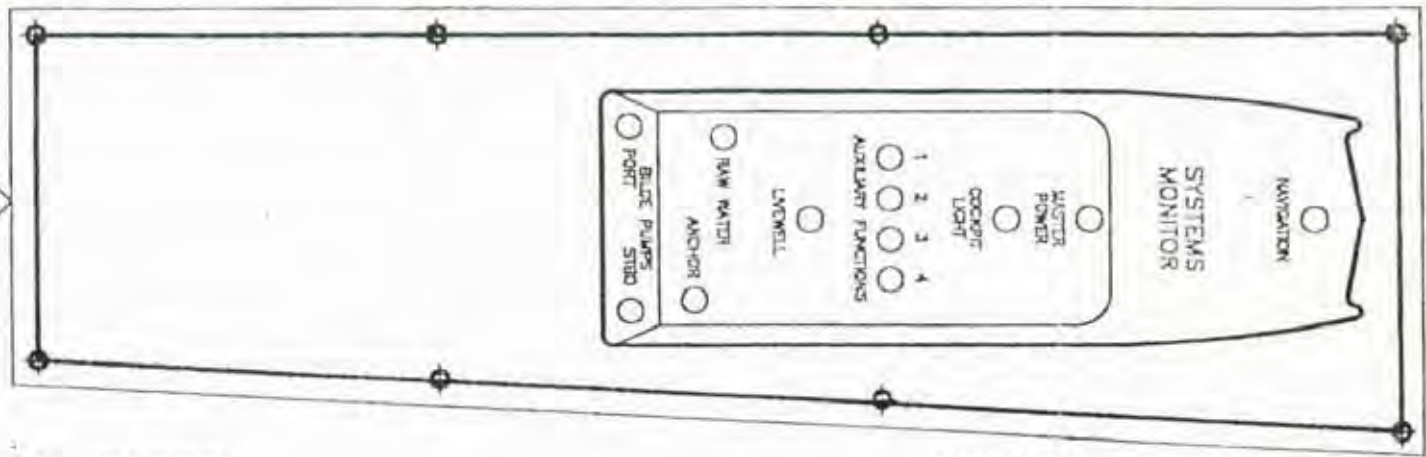
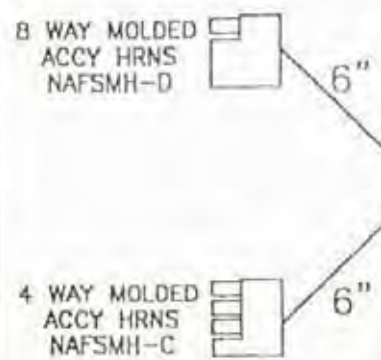

ASSEMBLY PARTS:

- ALL LIGHTS ARE SOLICO 14V LED LIGHTS
- "MASTER", 6401-14/BL BASE, RED LED, (1 REQ'D)
- ALL OTHERS, 6404-14/BL BASE, GREEN LED, (11 REQ'D)
- LIGHTS ARE MOUNTED USING TINNEMAN CLIPS, CLIPS ARE APPLIED FROM BACK OF LIGHT, SEE SAMPLE.
- 3SCIP, (12 REQ'D)
- HARNESS TO SWITCH PANEL, NAFSMH-C (1 REQ'D)
- HARNESS TO SWITCH PANEL, NAFSMH-D (1 REQ'D)
- PANEL, MACHINED & SCREENED, NAF007 (1 REQ'D)

NOTES:

- ALL LIGHTS ARE GROUND TO LEAD GROUND THAT CUSTOMER WILL WIRE INTO GROUND BLOCK
- LEAD FROM ONE SIDE OF THE LIGHT GOES TO THE SWITCH PANEL, LINE SIDE OF SWITCHES, THERE WILL BE A PIGGY BACK TERMINAL ON THAT SIDE OF THE LIGHT FOR THE CUSTOMER TO HOOK UP WIRE FROM ACCESSORY HRNS.
- SEE SAMPLE FOR WIRE PLACEMENT AND ROUTING OF HARNESSSES TO SWITCH PANEL.
- BACKSIDE OF PANEL IS SCREENED WITH THE FUNCTIONS FOR CUSTOMER REF WHEN ATTACHING THE MAIN HARNESS TO THE LIGHTS.
- SEE WIRING DIAGRAM FOR PROPER PLACEMENT OF ALL WIRES
- JUMPERS SHOULD BE TAKEN FROM CUTSHEET AND BE PLACED PER SAMPLE

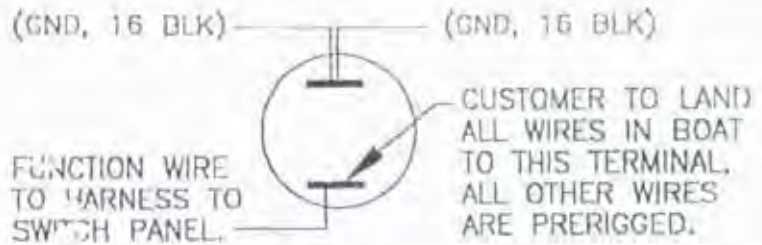

NOTE: FUNCTION WIRE ATTACHES TO THE + SIDE OF THE LIGHT, IT IS MARKED WITH A RED INK SPOT

FINAL ASSEMBLY PART NUMBER 09-0005

MACHINE & FABRICATION NOTES ALL DIMS ARE +/- .010 & ANGLES ARE +/- 1' UNLESS NOTED OTHERWISE FINISHED EDGES ARE INDICATED BY FINISH MARK PERIMETER EDGES ARE TO BE FINISHED, BREAK ALL CORNERS & EDGES ARE TO BE CLEAR AND FREE OF DEBRIS.		ATLANTIC MARINE PRODUCTS, INC DRN BY: GMM CHK BY: GMM SHEET OF 2 DATE DRAWN: 14AUG97 SCALE: 1:1 PWC NO.: NAF007 REVISION: 0	
--	--	---	--

8 7 6 5 4 3 2 1

THIS DRAWING IS THE PROPERTY OF ATLANTIC MARINE PRODUCTS, INC ANY INFORMATION, SPECS OR DESIGNS MAY NOT BE COPIED OR USED IN ANY WAY WITHOUT THE WRITTEN PERMISSION OF ATLANTIC MARINE PRODUCTS, INC. AND IT MUST BE RETURNED UPON REQUEST

REVISIONS				
ZONE	REV	DESCRIPTION	DATE	APPROVED

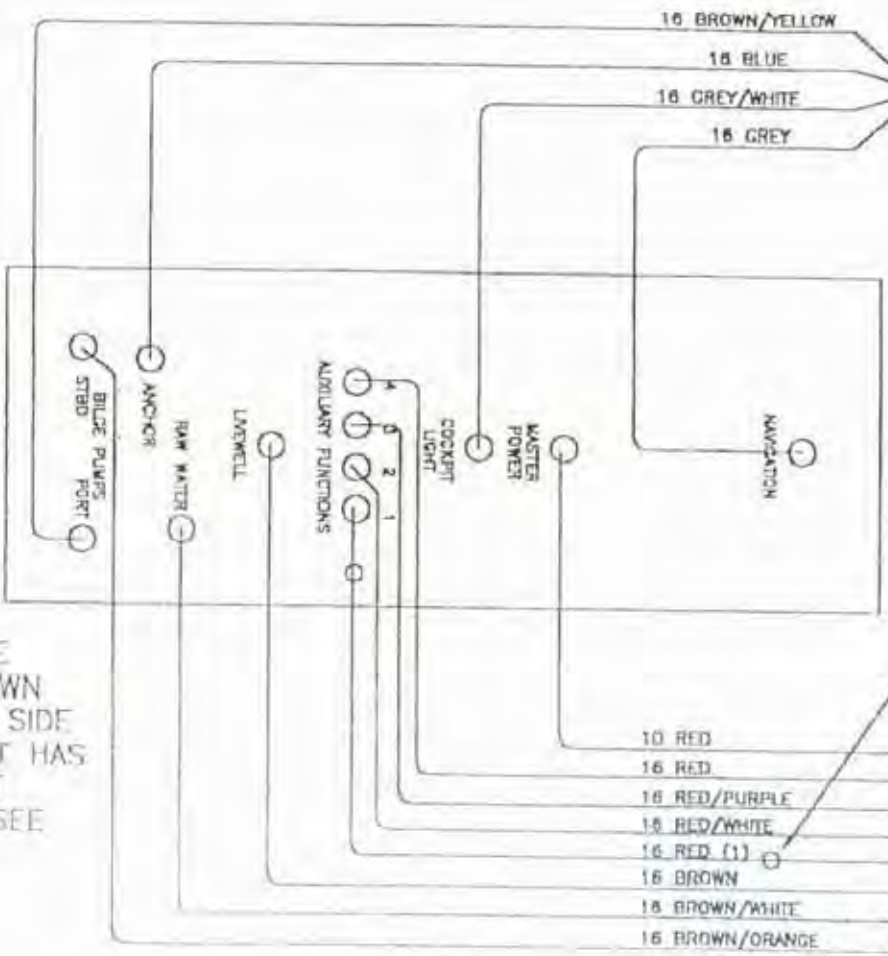

16 BROWN/YELLOW
18 BLUE
16 GREY/WHITE
16 GREY

4 WAY MOLDED HARNESS (NAFSMH-C) TO SWITCH PANEL PLUG (NAFSHR-C)

CUSTOMER WILL BRING 16 GA BLACK AND JUMP OFF NAVIGATION LIGHT FOR PROPER GROUND, AS INDICATED IN CUT SHEETS, PIGGYBACK TERMINAL SHOULD BE LEFT OPEN ON NAVIGATION LIGHT FOR CUSTOMER TO DO SO.

TAGGED "#1" FOR LOCATION PURPOSES, BOTH ENDS.

10 RED
16 RED
16 RED/PURPLE
16 RED/WHITE
16 RED (1)
16 BROWN
18 BROWN/WHITE
16 BROWN/ORANGE

8 WAY MOLDED HARNESS (NAFSMH-D) TO SWITCH PANEL PLUG (NAFSHR-D)

GROUND WIRES ARE NOT SHOWN REFER TO CUT SHEET FOR THE PROPER PLACEMENT AND LENGTH

WIRES FROM THE HARNESSES SHOWN GO TO THE (+) SIDE OF THE LIGHT, IT HAS A RED INK SPOT DENOTING (+). SEE SAMPLE ALSO.

NOTE

ALL WIRING DETAILS SHOULD BE TAKEN FROM OTHER DRAWINGS, THIS IS TO SHOW THE LOCATION OF THE WIRES FROM THE HARNESSES ONLY. EXACT LOCATION OF WIRES IN 8 & 4 WAY MOLDED PLUGS SHOULD BE TAKEN FROM THEIR SEPERATE DRAWINGS ALSO. *UMPER DETAILS CAN BE FOUND ON CUT SHEET. BREAK/UT LENGTHS FOR HARNESSES SHOULD BE TAKEN FROM FINAL ASSEMBLY DRAWING.

FINAL WIRING ASSEMBLY 09-0005

<p>MACHINE & FABRICATION NOTES ALL DIMS ARE +/- .010 & ANGLES ARE +/- 1° UNLESS NOTED OTHERWISE FINISHED EDGES ARE INDICATED BY FINISH MARK ✓ PERIMETER EDGES ARE TO BE FINISHED, BREAK ALL CORNERS & CHAMFER EDGES ARE TO BE CLEAN AND FREE OF DEBRIS.</p>		<p>ATLANTIC MARINE PRODUCTS, INC DRN BY: GMM CHK BY: GMM SHEET OF 1 DATE DRAWN: 7SEP97 SCALE: 1:1 DWG NO.: NAF007</p>		<p>WORLD CLASS CATAMARAN CEN CONSYS MON PNL REVISOR: 0</p>	
---	--	--	--	--	--

THIS DRAWING IS THE PROPERTY OF ATLANTIC MARINE PRODUCTS, INC. ANY INFORMATION, SPECS OR DESIGNS MAY NOT BE COPIED OR USED IN ANY WAY WITHOUT THE WRITTEN PERMISSION OF ATLANTIC MARINE PRODUCTS, INC. AND IT MUST BE RETURNED UPON REQUEST

REVISIONS				
ZONE	REV	DESCRIPTION	DATE	APPROVED

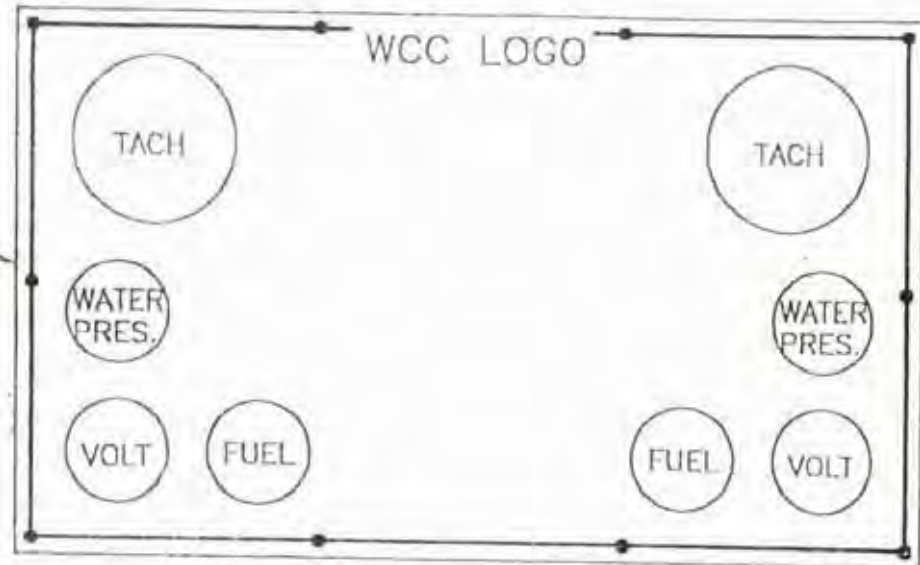

16 GA PURPLE, AND 16 GA BLACK LEADS FOR CUSTOMER TO HOOK UP, HANG OFF PANEL 12", TAPE 2 TOGETHER WITH RED TAPE FOR PORT DESIGNATION

16 GA PURPLE, AND 16 GA BLACK LEADS FOR CUSTOMER TO HOOK UP, HANG OFF PANEL 12", TAPE 2 TOGETHER WITH GREEN TAPE FOR STBD DESIGNATION

ASSEMBLY PARTS

- GAUGES ARE FARIA CHESAPEAKE WHITE SS SERIES
- TACH 7K = TC9863 / XI01900 (2 REQ'D)
- VOLTMETER = VP9158 / XY02400 (2 REQ'D)
- FUEL = GP9373 / XY02400 (2 REQ'D)
- WATER PRES. 30PSI = OP1022 / XU06900 (2 REQ'D)
- WATER PRESSURE KIT SHIPS WITH EVERY PANEL ASSEMBLY, INCLUDED WITH GAUGE. (2 REQ'D)
- PANEL, MACHINED & SCREENED, NAF005 (1 REQ'D)

NOTES

BASIC PREWIRE FOR ALL THE GAUGES WITH LEADS FOR THE PURPLE (IGN), BLACK (GND), BLUE (LIGHTS), RUN STBD AND PORT SIDE IGN SEPERATELY.

FINAL ASEMBLY PART NUMBER 09-0003

MACHINE & FABRICATION NOTES
 ALL DIMS ARE +/- .010 & ANGLES ARE +/- 1'
 UNLESS NOTED OTHERWISE
 FINISHED EDGES ARE INDICATED BY FINISH MARK ✓
 PERIMETER EDGES ARE TO BE FINISHED. BREAK ALL CORNERS TO BE CLEAR AND FREE OF DEBRIS.

ATLANTIC MARINE PRODUCTS, INC
 DRN BY: GML
 CHK BY: GML
 SHEET 1 OF 2
 DATE DRAWN: 17JUNE97
 SCALE: 1:1
 DWG NO.: NAF005
 REVISED: 0

THIS DRAWING IS THE PROPERTY OF ATLANTIC MARINE PRODUCTS, INC ANY INFORMATION, SPECS OR DESIGNS MAY NOT BE COPIED OR USED IN ANY WAY WITHOUT THE WRITTEN PERMISSION OF ATLANTIC MARINE PRODUCTS, INC. AND IT MUST BE RETURNED UPON REQUEST

ZONE REV		REVISIONS	DATE	APPROVED
		DESCRIPTION		

BASIC WIRING FOR 12 VOLT GAUGES

1 16 GAUGE PURPLE AND 16 GAUGE BLACK LEADS FOR CUSTOMER TO HOOK UP, HANG 12" FROM PANEL, NO TERMINATIONS. PORT AND STBD ARE WIRED SEPERATE, THE ONLY COMMON WIRE BETWEEN PORT & STBD IS THE 16 GA BLUE FOR THE LIGHTS.

2 CUSTOMER TO RUN WIRES FOR SIGNAL TO THE TACH AND THE FUEL FROM THE MAIN HARNESS. WATER PRESSURE WILL BE HOOKED UP BY CUST. HARDWARE FOR WATER PRESSURE GAUGE IS WITH EACH INSTRUMENT PANEL.

3 GAUGES ARE FARIA CHESAPEAKE SS WHITE SERIES
 TACHOMETER, 7K TC9863
 WATER PRES 30PSI OP1022
 FUEL LEVEL GP9373
 VOLTMETER VP9158

4 PLEASE REFER TO THE FARIA MANUAL FOR THE PROPER TACH SETTINGS AND CARE FOR THESE GAUGES: DO NOT OVER TORQUE THE BRACKETS, IT MAY CAUSE DAMAGE TO THE GAUGE HOUSING AND INTERIOR PARTS.

THIS WIRING DIAGRAM COVERS BOTH THE CENTER CONSOLE AND THE CUDDY CABIN MODEL INSTRUMENT PANEL ASSEMBLIES: CENTER CONSOLE 09-0006 CUDDY CABIN 09-0003

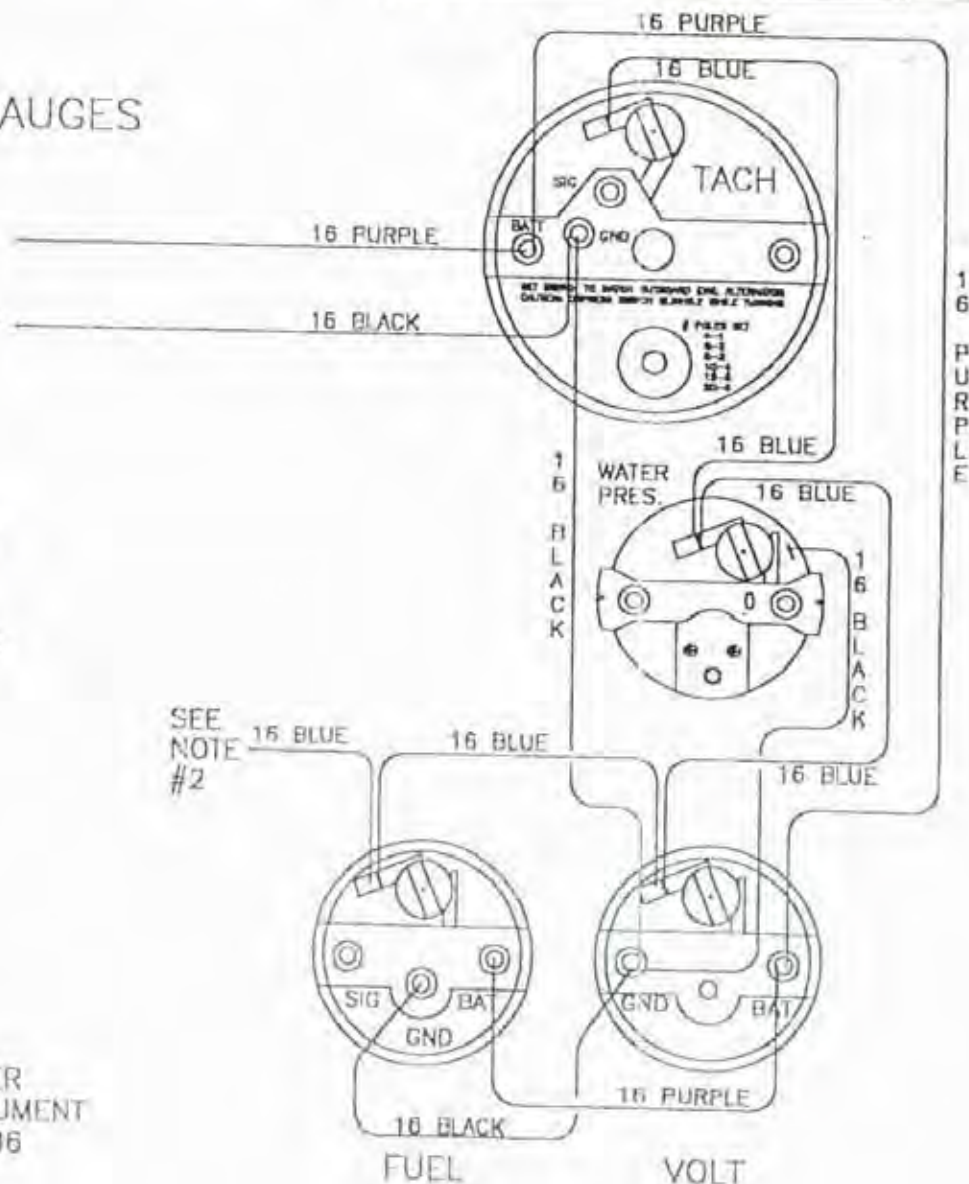

MACHINE & FABRICATION NOTES
 ALL DIMS ARE +/- .010 & ANGLES ARE +/- 1'
 UNLESS NOTED OTHERWISE
 PERIMETER EDGES ARE TO BE FINISHED, BREAK ALL SHARP EDGES AND CORNERS. PARTS ARE TO BE CLEAR AND FREE OF BURRS.

ATLANTIC MARINE PRODUCTS, INC
 DRN BY: GML
 CHK BY: GML
 SHEET 1 OF X
 DATE DRAWN: 11/11/00
 Dwg No. 09-0006

THIS DRAWING IS THE PROPERTY OF ATLANTIC MARINE PRODUCTS, INC ANY INFORMATION, SPECS OR DESIGNS MAY NOT BE COPIED OR USED IN ANY WAY WITHOUT THE WRITTEN PERMISSION OF ATLANTIC MARINE PRODUCTS, INC. AND IT MUST BE RETURNED UPON REQUEST

REVISIONS				
ZONE	REV	DESCRIPTION	DATE	APPROVED

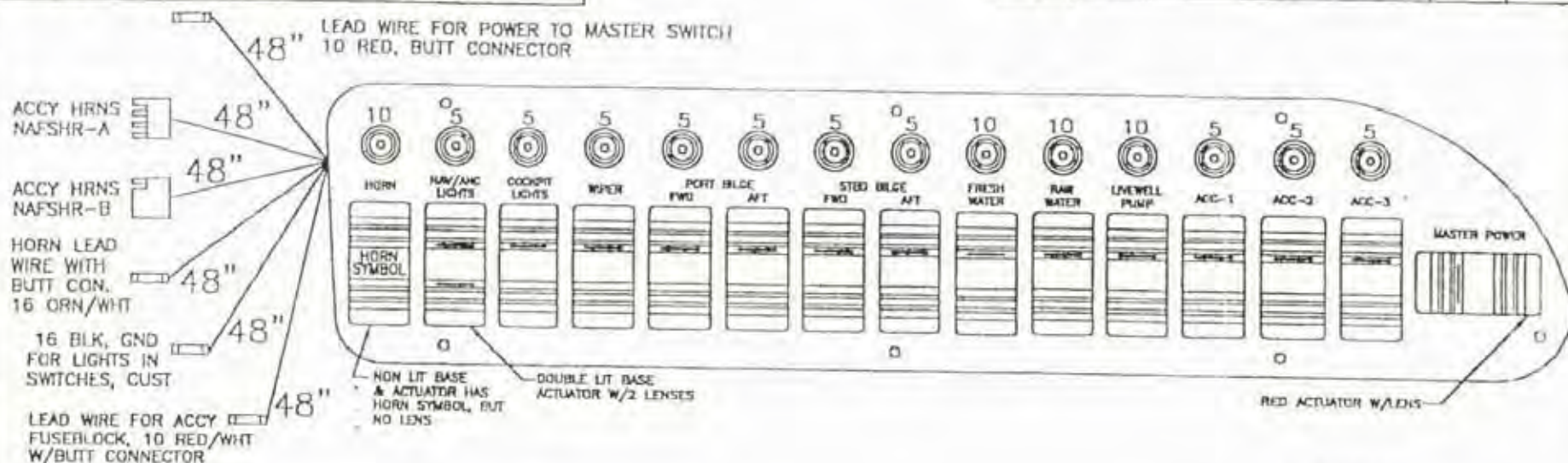

ASSEMBLY PARTS:

CARLING CONTURA III ROCKERS WITH ACUATORS, LIT AND NON LIT BASES, AND 4 STYLES OF ACUATORS BASES ARE AS FOLLOWS:

NAV-ANC, DPDT ON-OFF-ON, DOUBLE LIGHTS, VJD1D66B-00000-000 (1 REQ'D)
 HORN, SPST OFF-MOM, NON LIT, V2D1S00B-00000-000 (1 REQ'D)
 ALL OTHERS, SPST, OFF-ON, LIT, VIDAB60B-00000-000 (13 REQ'D)

ACTUATORS ARE AS FOLLOWS:

NAV-ANC, HARD BLACK, 2 RED LENS, WCNCOO, (1 REQ'D)
 MASTER, HARD RED, 1 LENS, WCM500, (1 REQ'D)
 HORN, HARD BLACK, HORN SYMBOL, NO LENS, WGCZCX-XHN3 (1 REQ'D)
 ALL OTHERS, HARD BLACK, 1 LENS, WCMCOO, (12 REQ'D)

CIRCUIT BREAKERS ARE MPI THERMAL TRIP FREE PUSH TO RESET

5 AMP, 1680-217-050-97, (10 REQ'D)
 10 AMP, 1680-217-100-97, (4 REQ'D)

CLEAR BOOTS FOR CIRCUIT BREAKERS, C1221/24-4-CLEAR, (14 REQ'D)

PANEL HARNESSSES, MOLDED 8 WAYS
 NAFSHR-A (1 REQ'D) NAFSHR-B (1 REQ'D)
 SEE SAMPLE FOR EXACT PLACEMENT

PANEL, MACHINED & SCREENED, NAF001 (1 REQ'D)

NOTES

JUMPERS AND PREWIRE SHOULD BE TAKEN FROM CUTSHEETS AND BE PLACED PER SAMPLE.

SEE SEPERATE DRAWING FOR THE WIRING OF THE NAV-ANC SWITCH, MASTER SWITCH, AND THE WIPER SWITCH, ALSO SEE SAMPLE.

SEE WIRING DIAGRAM FOR PROPER PLACEMENT OF ALL WIRES

FINAL ASSEMBLY PART NUMBER 09-0001

MACHINE & FABRICATION NOTES
 ALL DIMS ARE +/- .010 & ANGLES ARE +/- 1°
 UNLESS NOTED OTHERWISE
 FINISHED EDGES ARE INDICATED BY FINISH MARK
 BREAK ALL SHARP EDGES AND CORNERS. PARTS ARE TO BE CLEAR AND FREE OF DETRICE

ATLANTIC MARINE PRODUCTS, INC
 DRN BY: GMM
 CHK BY: GMM
 SHEET 1 OF 2
 DATE DRAWN: 1-1-11
 DWG NO. 09-0001
 WORLD CLASS CATAKARAN
 25 CABIN SWITCH PNL
 REVISION

THIS DRAWING IS THE PROPERTY OF ATLANTIC MARINE PRODUCTS, INC ANY INFORMATION, SPECS OR DESIGNS MAY NOT BE COPIED OR USED IN ANY WAY WITHOUT THE WRITTEN PERMISSION OF ATLANTIC MARINE PRODUCTS, INC. AND IT MUST BE RETURNED UPON REQUEST

ZONE REV		DESCRIPTION	DATE	APPROVED

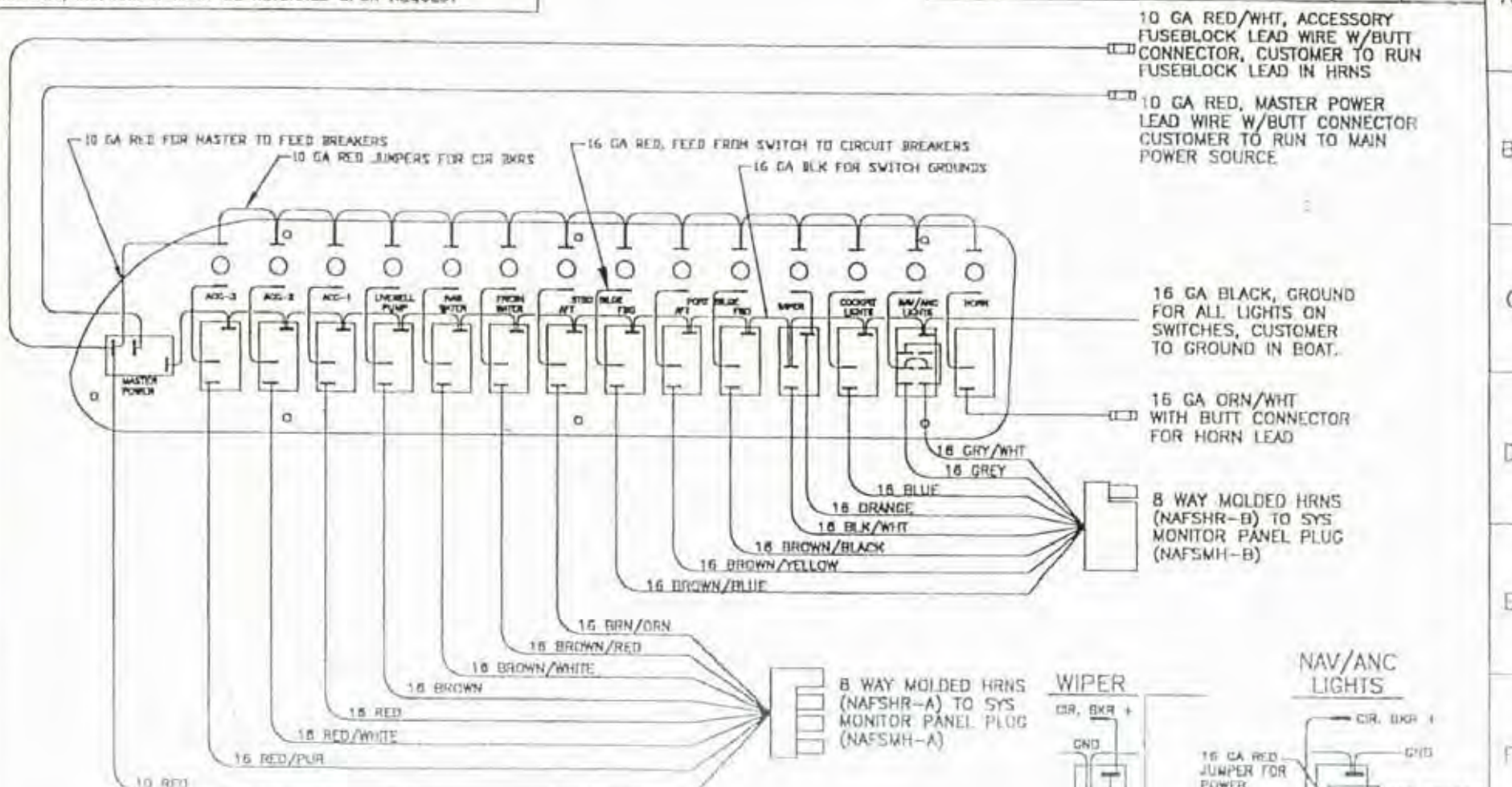

NOTE

ALL WIRING DETAILS SHOULD BE TAKEN FROM OTHER DRAWINGS, THIS IS TO SHOW THE LOCATION OF THE WIRES FROM THE HARNESSSES ONLY, DETAILS OF WIPER AND THE NAV-ANC SWITCH ARE GIVEN FOR PLACEMENT OF WIRES ONLY. EXACT LOCATION OF WIRES IN 8 WAY MOLDED PLUGS SHOULD BE TAKEN FROM THEIR SEPERATE DRAWINGS ALSO. JUMPER DETAILS CAN BE FOUND ON CUT-SHEETS. BREAKOUT LENGTHS FOR HRNS AND LEADS SHOULD BE TAKEN FROM FINAL ASSEMBLY PRINTS

FINAL WIRING ASSEMBLY

MACHINE & FABRICATION NOTES		ATLANTIC MARINE PRODUCTS, INC	
ALL DIMS ARE +/- .010 & ANGLES ARE +/- 1° UNLESS NOTED OTHERWISE		DRN BY: GMM	WORLD CLASS CATAMARAN
FINISHED EDGES ARE INDICATED BY FINISH MARK ✓		CHK BY: GMM	25 CABIN SWITCH PNL
PERIMETER EDGES ARE TO BE FINISHED, BREAK ALL SHARP EDGES AND CORNERS, PARTS ARE TO BE CLEAR AND FREE OF DEBRIS		SHEET 1 OF 1	DATE DRAWN: 8/10/97
		SCALE: NTS	DRG NO: NAF001
			REVISION: 0

8 7 6 5 4 3 2 1

THIS DRAWING IS THE PROPERTY OF ATLANTIC MARINE PRODUCTS, INC ANY INFORMATION, SPECS OR DESIGNS MAY NOT BE COPIED OR USED IN ANY WAY WITHOUT THE WRITTEN PERMISSION OF ATLANTIC MARINE PRODUCTS, INC. AND IT MUST BE RETURNED UPON REQUEST

REVISIONS				
ZONE	REV	DESCRIPTION	DATE	APPROVED

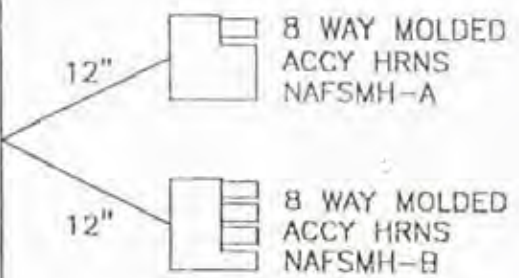
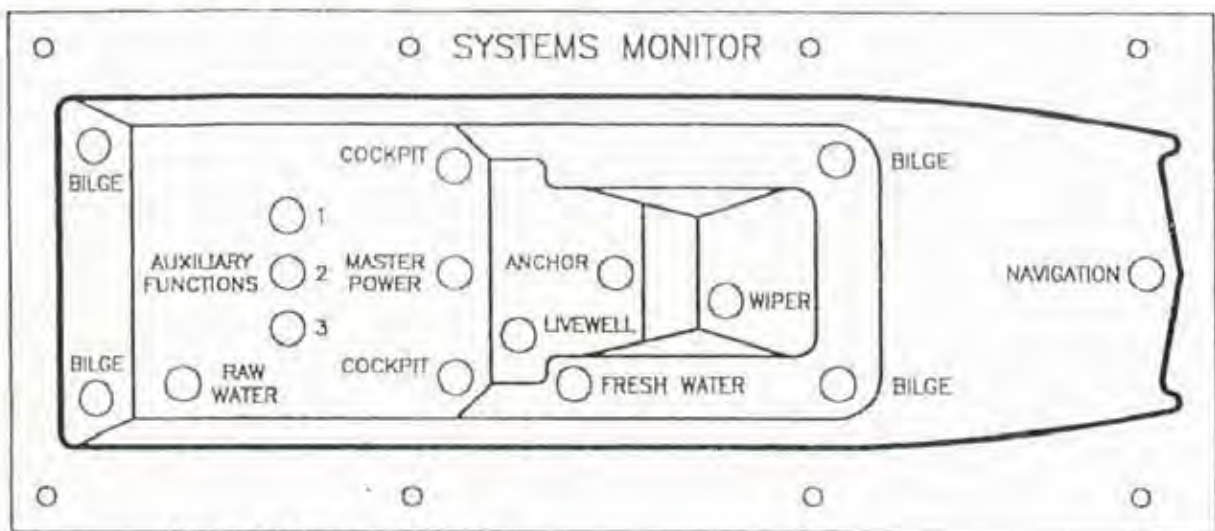

CUSTOMER TO RUN 16 GA BLACK FROM PANEL TO GROUND BLOCK.

NOTES:

ALL LIGHTS ARE GROUND TO LEAD GROUND THAT CUSTOMER WILL WIRE INTO GROUND BLOCK
 LEAD FROM ONE SIDE OF THE LIGHT GOES TO THE SWITCH PANEL, LINE SIDE OF SWITCHES, THERE WILL BE A PIGGY BACK TERMINAL ON THAT SIDE OF THE LIGHT FOR THE CUSTOMER TO HOOK UP WIRE FROM ACCESSORY HRNS.
 SEE SAMPLE FOR WIRE PLACEMENT AND ROUTING OF HARNESSSES TO SWITCH PANEL.
 BACKSIDE OF PANEL IS SCREENED WITH THE FUNCTIONS FOR CUSTOMER REF WHEN ATTACHING THE MAIN HARNESS TO THE LIGHTS.
 SEE WIRING DIAGRAM FOR PROPER PLACEMENT OF ALL WIRES
 JUMPERS SHOULD BE TAKEN FROM CUTSHEET AND AND BE PLACED PER SAMPLE

ASSEMBLY PARTS:

- ALL LIGHTS ARE SOLICO 14V LED LIGHTS
- "MASTER", 6401-14/BL BASE, RED LED, (1 REQ'D)
- ALL OTHERS, 6404-14/BL BASE, GREEN LED, (15 REQ'D)
- LIGHTS ARE MOUNTED USING TINNEMAN CLIPS, CLIPS ARE APPLIED FROM BACK OF LIGHT, SEE SAMPLE.
- 3SCIP, (16 REQ'D)
- HARNESS TO SWITCH PANEL, NAFSMH-A (1 REQ'D)
- HARNESS TO SWITCH PANEL, NAFSMH-B (1 REQ'D)
- PANEL, MACHINED & SCREENED, NAF008 (1 REQ'D)

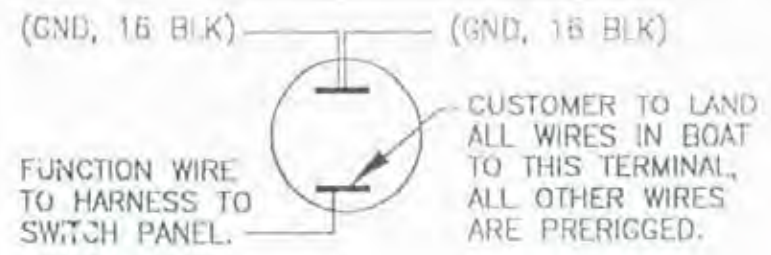

NOTE: FUNCTION WIRE ATTACHES TO THE + SIDE OF THE LIGHT, IT IS MARKED WITH A RED INK SPOT.

FINAL ASSEMBLY PART NUMBER 09-0002

MACHINE & FABRICATION NOTES		ATLANTIC MARINE PRODUCTS, INC	
ALL DIMS ARE +/- .010 & ANGLES ARE +/- 1° UNLESS NOTED OTHERWISE		DRN BY: GMM	
FINISHED EDGES ARE INDICATED BY FINISH MARK		CHK BY: GMM	
PERIMETER EDGES ARE TO BE FINISHED, BREAK ALL CORNERS & ROUNDS TO BE CLEAR AND FREE OF DEBRIS.		WORLD CLASS CATAMARAN	
DATE DRAWN: 26 JUNE 97		CABIN BOAT SYS MON PNL	
SCALE: 1:1		DRG NO. NAF008	
		REVISION: 0	

THIS DRAWING IS THE PROPERTY OF ATLANTIC MARINE PRODUCTS, INC. ANY INFORMATION, SPECS OR DESIGNS MAY NOT BE COPIED OR USED IN ANY WAY WITHOUT THE WRITTEN PERMISSION OF ATLANTIC MARINE PRODUCTS, INC. AND IT MUST BE RETURNED UPON REQUEST

REVISIONS				
ZONE	REV	DESCRIPTION	DATE	APPROVED

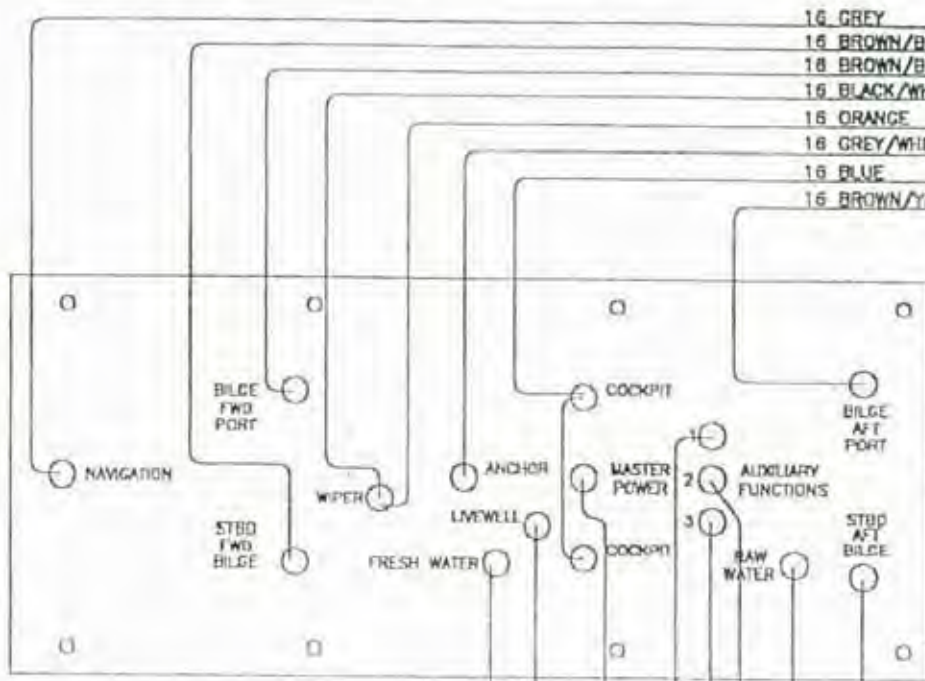

- 16 GREY
- 16 BROWN/BLUE
- 16 BROWN/BLACK
- 16 BLACK/WHITE
- 16 ORANGE
- 16 GREY/WHITE
- 16 BLUE
- 16 BROWN/YELLOW

8 WAY MOLDED HARNESS (NAFSMH-B) TO SWITCH PANEL PLUG (NAFSHR-B)

DETAILS

16 GA ORANGE, + SIDE OF LIGHT
TERMINAL WITH RED INK SPOT

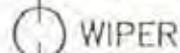

16 BLACK/WHITE, - SIDE OF LIGHT

JUMPER BETWEEN THE COCKPIT IND. LIGHTS IS FROM + TO + 16 GAUGE BLUE, SEE CUT SHEET.

CUSTOMER WILL BRING 16 GA BLACK AND JUMP OFF NAVIGATION LIGHT FOR PROPER GROUND, AS INDICATED IN CUT SHEETS, PIGGYBACK TERMINAL SHOULD BE LEFT OPEN ON NAV LIGHT TO DO SO

- 16 BROWN/ORANGE
- 16 BROWN/WHITE
- 16 RED/WHITE
- 16 RED/PURPLE
- 16 RED
- 10 RED
- 16 BROWN
- 16 BROWN/RED

8 WAY MOLDED HARNESS (NAFSMH-A) TO SWITCH PANEL PLUG (NAFSHR-A)

GROUND WIRES ARE NOT SHOWN REFER TO CUT SHEET FOR THE PROPER PLACEMENT AND LENGTH

WIRES FROM THE HARNESSES SHOWN GO TO THE (+) SIDE OF THE LIGHT, IT HAS A RED INK SPOT DENOTING (+). SEE SAMPLE ALSO.

NOTE

ALL WIRING DETAILS SHOULD BE TAKEN FROM OTHER DRAWINGS, THIS IS TO SHOW THE LOCATION OF THE WIRES FROM THE HARNESSES ONLY. DETAIL OF WIPER IND LIGHT IS GIVEN FOR PLACEMENT OF WIRES ONLY. EXAC. LOCATION OF WIRES IN 8 WAY MOLDED PLUGS SHOULD BE TAKEN FROM THEIR SEPERATE DRAWINGS ALSO. JUMPER DETAILS CAN BE FOUND ON CUT SHEET. BREAKOUT LENGTHS FOR HARNESSES SHOULD BE TAKEN FROM FINAL ASSEMBLY DRAWING.

FINAL WIRING ASSEMBLY 09-0002

<p>MACHINE & FABRICATION NOTES ALL DIMS ARE +/- .010 & ANGLES ARE +/- 1° UNLESS NOTED OTHERWISE FINISHED EDGES ARE INDICATED BY FINISH MARK ALL EDGES SHOULD BE DEBURRED, BREAK ALL SHARP EDGES AND CORNERS, PARTS ARE TO BE CLEAR AND FREE OF DEBRIS.</p>		<p>ATLANTIC MARINE PRODUCTS, INC DRN BY: GMM CHK BY: GMM SHEET 1 OF 3 DATE DRAWN: 26 JUN 97 SCALE: 1:1 DWG NO: NAF008 REVISION: 0</p>	
<p>WORLD CLASS CATAMARAN CABIN BOAT SYS MON PH</p>		<p> </p>	

REV	DATE	BY	CHK
B	07/04/97	B-HM	AJZ

CONCEPT 0 WIRING DIAGRAM

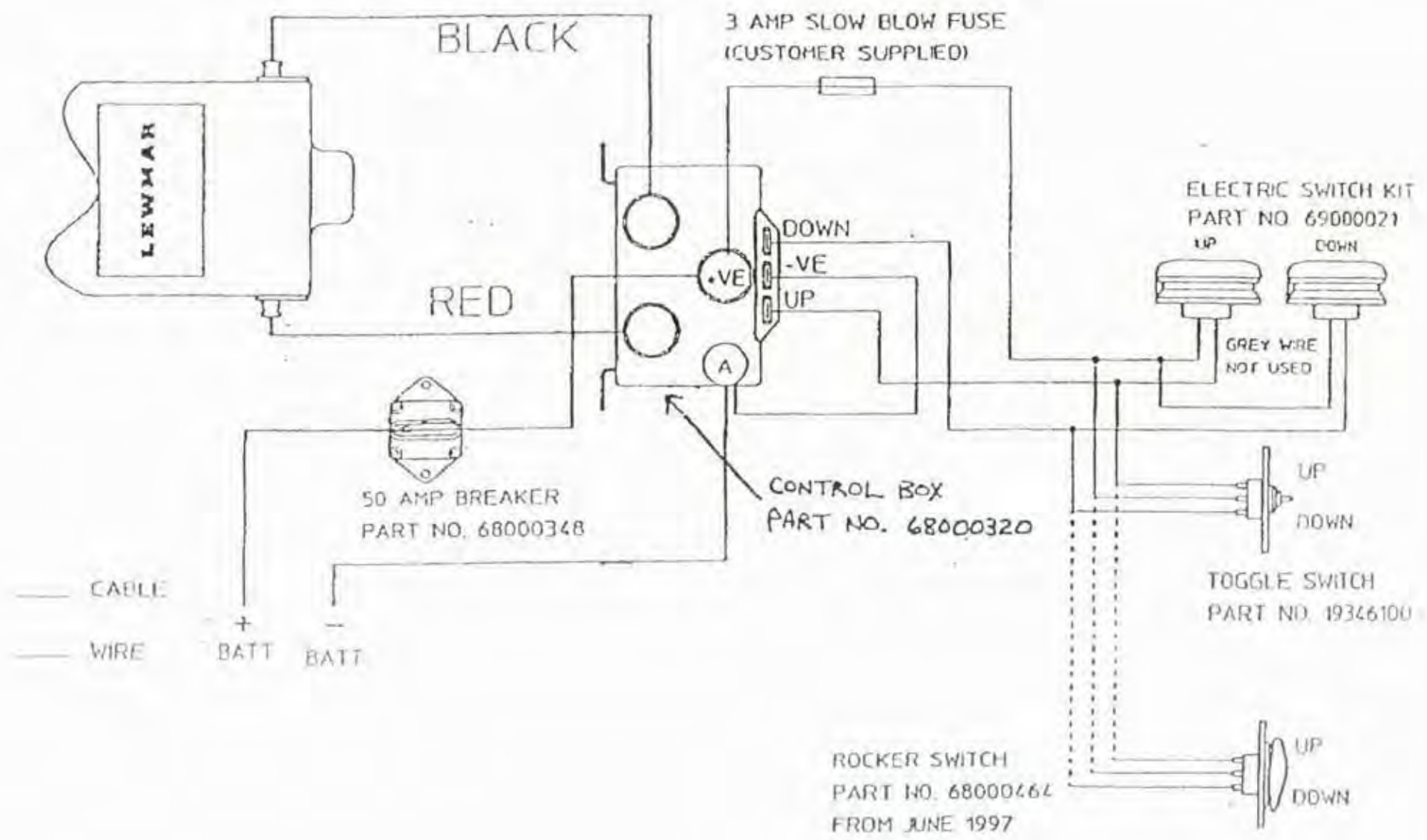

DRW	A_HCC	FIG No	WSD0751	LEWMAR
DATE	16.01.97			

Operation and Maintenance Guide

The Lewmar Concept Windlass installed on your boat is an automatic rope/chain anchor windlass. The unit is designed to use 1/4" ACCO G40 chain, spliced to 1/2" 3 strand nylon. The unit is operated with a toggle switch located at your helm station. This toggle operates the windlass in both the up and down direction.

Anchoring:

1- Before anchoring the retaining clip that is attached to your chain should be released to allow the free running of the anchor rode.

2- Release the anchor and rode by pressing down on the toggle switch. Allow the line to run out to an appropriate length for the depth of water you are anchoring. Pausing periodically will allow your boat to drift back, both setting the anchor, and allowing the slack to come out of your anchor rode.

3- When your anchor is secure, and you have let out the proper amount of scope you should tie off your rode to a cleat. This provides a safe holding point for the boat. Although the windlass will hold the boat, it is always best to tie your rode off for long periods of time preventing excess strain on the windlass.

Anchor Retrieval:

1- When you are ready to pull up your anchor, untie your rode allowing the windlass to retrieve your anchor rode.

2- Although the windlass is designed to pull more than the weight of the anchor and rode, it is best to assist it by using your engines. The speed of your boat should be consistent with both wind and current, making sure that you are not driving over the rode as the windlass retrieves it.

3- During anchor retrieval the rode may begin to pile up beneath the windlass motor. Obstructions in the locker can prevent the rode from sliding into the deepest part of the locker. The rode may jam the windlass, and cause the windlass to stop if it piles up high enough. To prevent any complications during the retrieval of your anchor it is recommended that the line be cleared from beneath the windlass approximately every 50 feet.

4- When it is time to break the anchor loose from the bottom you should always use your engines to assist the windlass. The power located in your engines is far greater than the windlass.

5- Care should be taken when you reach the chain section of your rode, to slow your retrieval down to prevent the anchor from overriding the anchor roller.

6- When the anchor is up and safely in the anchor roller, replace the retaining clip for safe operation of your boat.

Other Tips:

1- To help in anchoring and retrieval it is good to mark your rode with an oil based paint every 50 feet to allow a visual guide to the amount of rode that is released. It is also beneficial to mark the last few feet of the chain to indicate when the anchor is about to enter the roller.

2- If the unit jams it can be cleared by operating in the opposite direction releasing the kink in the rode, or any obstructions. Sometimes it may be necessary to inspect the rope for kinks in order to prevent any jamming of the windlass.

Maintenance:

1- The windlass is designed to operate in the marine environment, however like any equipment that is exposed to salt water it should be rinsed with fresh water. Rinsing the unit on a regular basis will prevent salt deposits, which may lead to poor operation of the unit, or corrosion.

2- The windlass controller is a small black box, which contains the solenoids that operate your windlass in the up and down directions. This is located in the anchor locker, and should be checked periodically for any corrosion. To prevent any corrosion a light coating of grease should be applied to the terminals and studs located on the box. A water proof grease similar to that used in fishing reels, and bicycle hubs may be used.