

# **MARK I/MARK II STERN DRIVES**

---

INTRODUCTION  
INSTALLATION  
MAINTENANCE



# **BMW MARINE**

<https://www.boat-manuals.com/>



**BMW MARINE**

---

## V12 ENGINEERING

428 Second St. Kenora  
Ontario Canada  
P9N 1G6

Ph: 1-807-543-3003

[bmwmarine.com](http://bmwmarine.com)



# MARK I/MARK II STERN DRIVES

---



BMW MARK I STERN DRIVE



BMW MARK II STERN DRIVE

# Contents

---

<b>Introduction</b> .....	5
Comparing the Mark I and Mark II .....	5
Water Inlet and Prop Collar ...	5-6
U-joint .....	6
Serial Number and Prop Ratio ...	6
Stern Drive Operation .....	6
Power Trim/Tilt System .....	6

© Copyright 1984 by  
BMW of North America, Inc.

All rights reserved. This book may not be reproduced in whole or in part without the express permission of BMW of North America, Inc.

BMW of North America, Inc. reserves the right at any time to make changes or modifications to systems, procedures, descriptions, and illustrations contained in this book without necessarily updating this document. Information herein is current as of May, 1984.



<b>Installation</b> .....	7
Preparing the Transom Shield ...	7
Installing the Power Trim Pump .....	7
Installing the Electrical Panel ...	7
Installing Hydraulic Control Lines .....	8
Mounting the Exhaust Horn .....	8
Installing the Shift Cable .....	8
Installing Trim Wire Conduit .....	8
Installing Hydraulic Hoses .....	8-9
Installing U-joint and Exhaust Boots .....	9
Attaching Drive Unit to Transom Shield .....	9
Adjusting Sending Unit .....	10

<b>Maintenance</b> .....	11
Adjusting Shift Cable .....	11-12
Adjusting Trim Tabs .....	12
Checking Stern Drive Oil ...	12-13
Checking Zinc Anodes .....	14
Replacing Rubber Hoses and Boots .....	14
Preventing Corrosion .....	14
Checking Hydraulic Fluid in Trim/Tilt System .....	14
<b>Special Tools</b> .....	16-17
<b>Stern Drive Electrical System</b> .....	18-19
<b>Stern Drive Hydraulic System</b> .....	20
<b>Specifications</b> .....	21

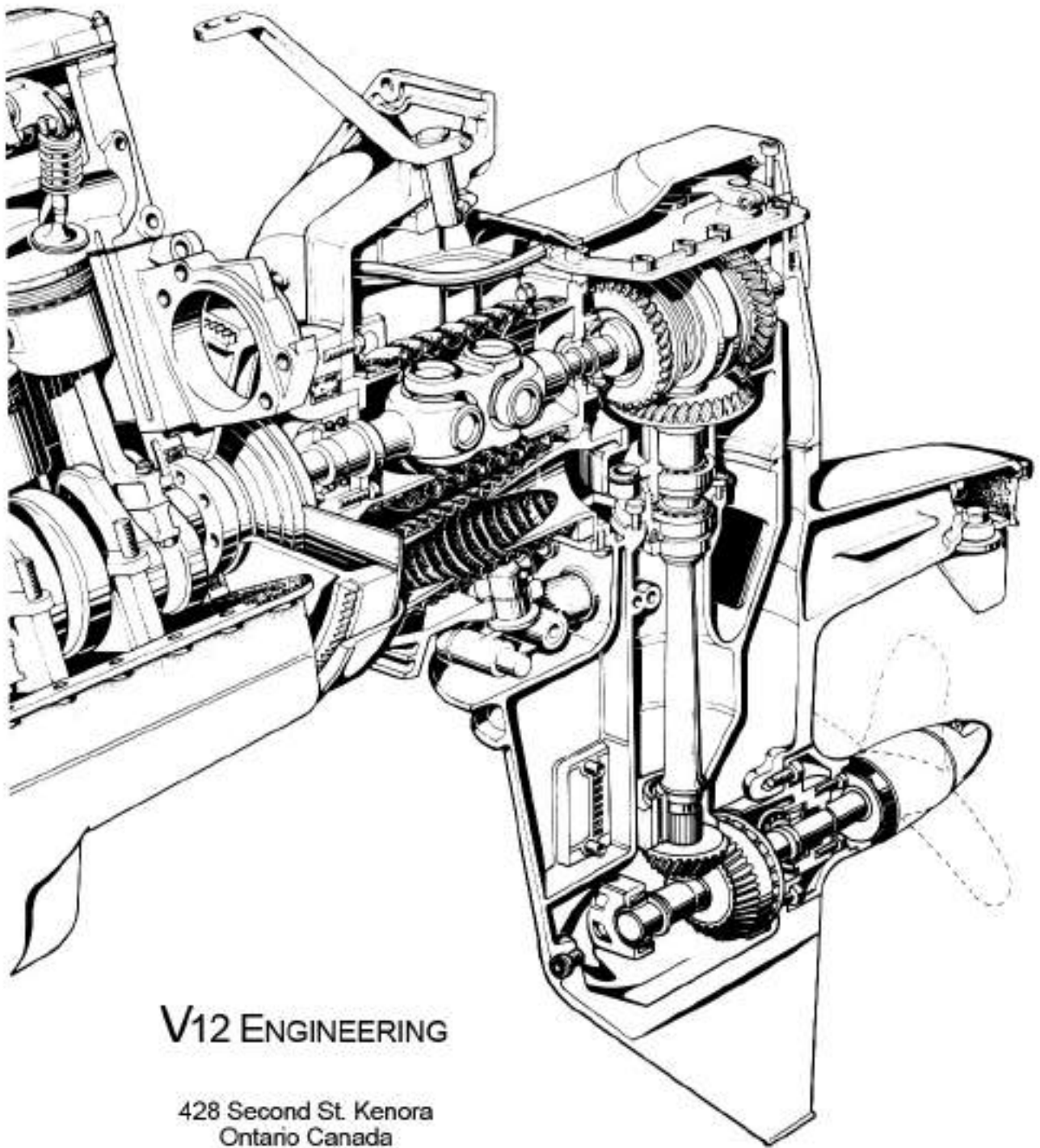

## V12 ENGINEERING

428 Second St. Kenora  
Ontario Canada  
P9N 1G6

Ph: 1-807-543-3003

[bmwmarine.com](https://www.bmwmarine.com/) <https://www.boat-manuals.com/>

# Introduction



For many years, serious boating enthusiasts have been seeking an advantage. BMW Marine offers one.

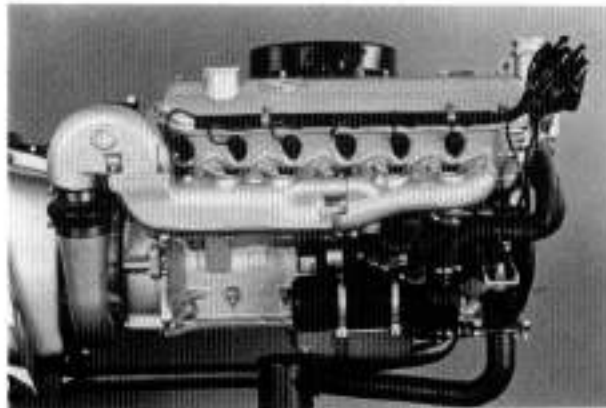

## BMW Gasoline Engine

From the lightweight, economical 7 and 12 horsepower diesel engines to the incredibly smooth running 6-cylinder gasoline engines, BMW offers a marine engine for every application.

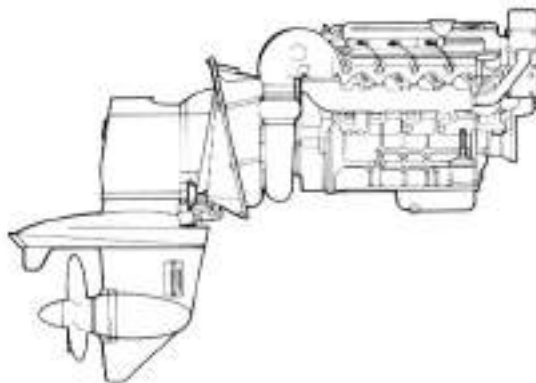

## BMW Engine and Stern Drive

But the BMW Marine advantage is that BMW Marine engines are mated to BMW stern drives.

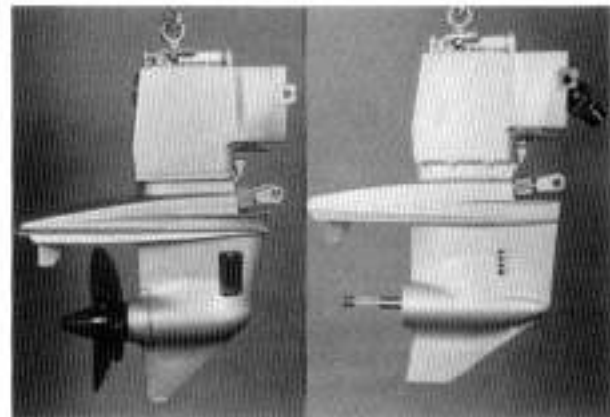

Mark I Stern Drive

Mark II Stern Drive

The BMW Mark I stern drive, on the left, and the latest stern drive, the Mark II, on the right, provide boaters with the ultimate in marine drive units.

## BMW Stern Drives

- *Introduction*
- *Installation*
- *Maintenance*

This booklet will introduce you to the Mark I and Mark II stern drives and give you important installation and maintenance information.

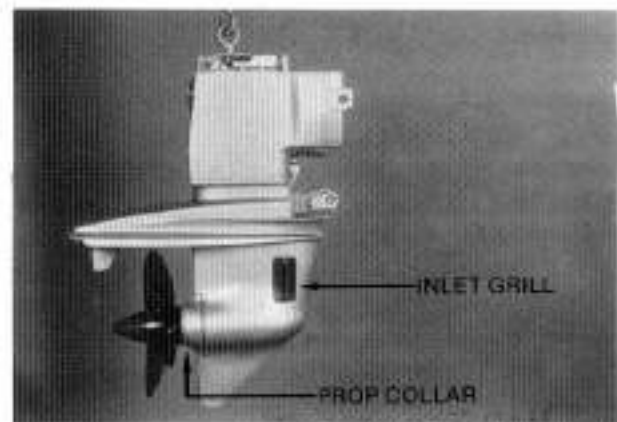

Mark I

The Mark I stern drive is easily identified by its removable water inlet grill and zinc prop collar.

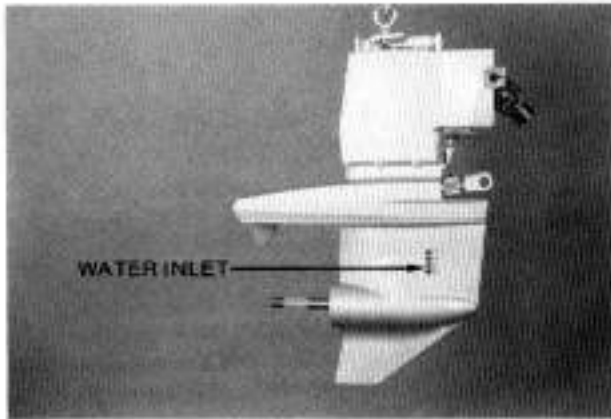

**Mark II**

On the Mark II stern drive, the water inlet is cast into the housing and no prop collar is used.



**Prop Ratio Stamp**

In case the plate becomes damaged, the serial number is also stamped into the housing directly under the plate, and the prop ratio is stamped on the end of the stern drive output shaft.

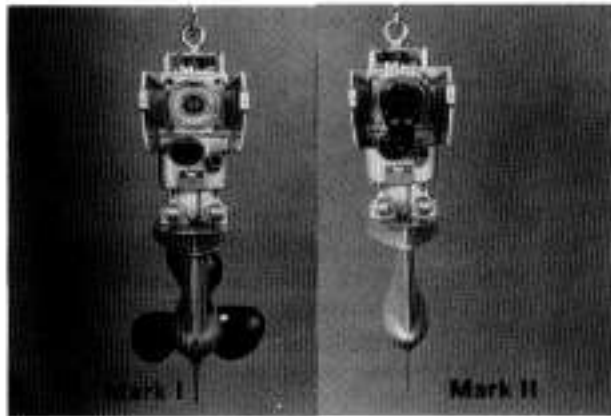

Another difference is the placement of the U-joint. With the Mark I, the U-joint is on the engine. But a U-joint is part of the Mark II stern drive. Always use never-sieze when assembling the U-joint on the engine output shaft.

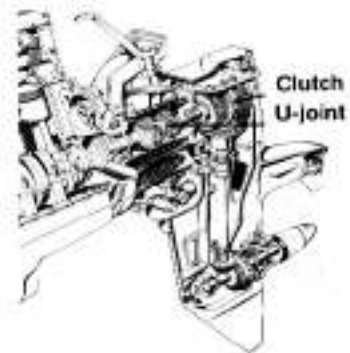

Both stern drives operate through a U-joint and a forward/reverse clutch. Gears are spiral cut for quiet operation and increased durability.

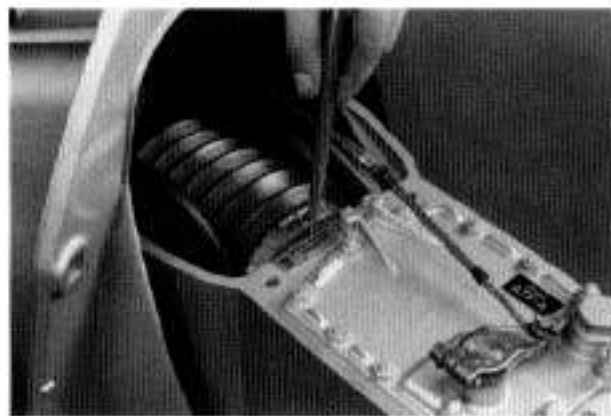

**Serial Number Plate**

On both stern drives, the serial number and prop ratio are stamped on a plate on top of the unit.



The power trim/tilt system has been built into the stern drive to protect it from debris. The BMW stern drive can be trimmed at any speed for maximum economy and performance.





## BMW Stern Drives

- Introduction
- **Installation**
- Maintenance

Installing the stern drive involves these steps: preparing the transom shield, making hydraulic and mechanical connections, and mounting the stern drive to the transom shield.



**Transom Shield**

The transom shield mounts on the boat transom. In turn, the stern drive mounts on a steering yoke in the transom shield. The transom shield must be prepared before the stern drive can be installed.

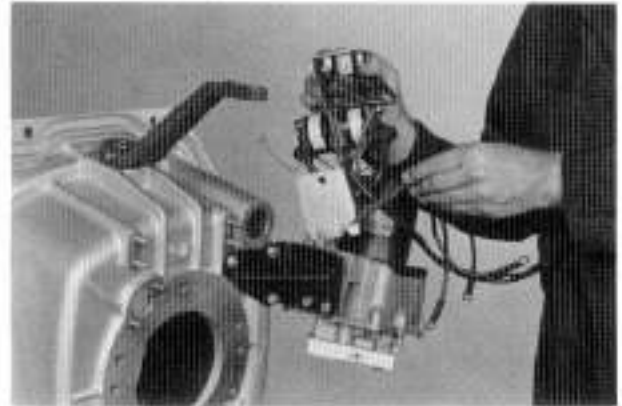

**Trim Pump and Electrical Panel**

To prepare the transom shield, install the power trim pump and stern drive electrical panel. The electrical panel mounts between the transom shield and trim pump and includes circuit breakers for the trim/tilt relay system.



**Hydraulic Control Lines Installed**

With the power trim pump and electrical panel installed, add the hydraulic control lines to the transom. When you install the hydraulic lines, loosen the pump mounting bracket, fit and tighten the hydraulic lines, and finally, tighten the pump bracket. This procedure eliminates unnecessary strain on the hydraulic lines.

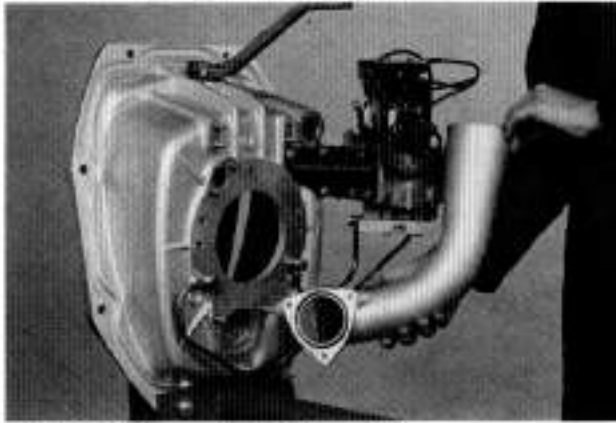

### Exhaust Horn and Backflow Valve

The next part of preparing the transom shield is mounting the exhaust horn. To protect the engine, a backflow valve is fitted to the Mark II exhaust horn. Press the valve into the horn with the flaps vertical.

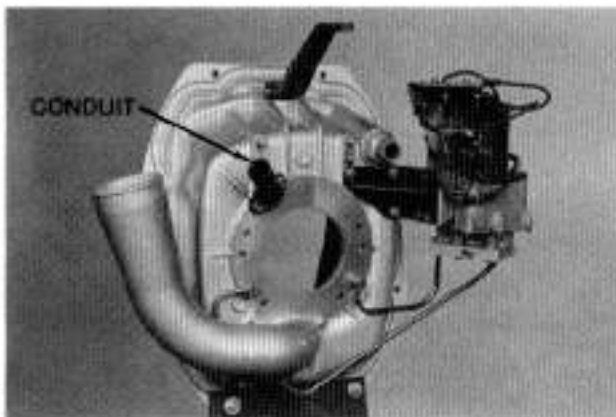

### Conduit Installed

Finally, install the shift cable and trim wire conduit. The conduit protects the electrical wires and stern drive shift cable as they pass through the transom shield. For the greatest protection, BMW provides a rubber gasket between the conduit and the transom shield. Make certain this gasket is in place.

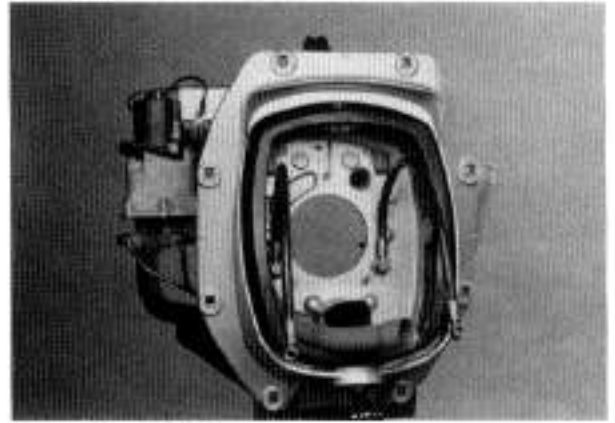

### Hoses Installed

With the transom shield prepared, and working from the outboard side of the shield, install the two flexible hydraulic trim/tilt hoses and the fresh water intake hose. The hoses must be routed inside the steering yoke.

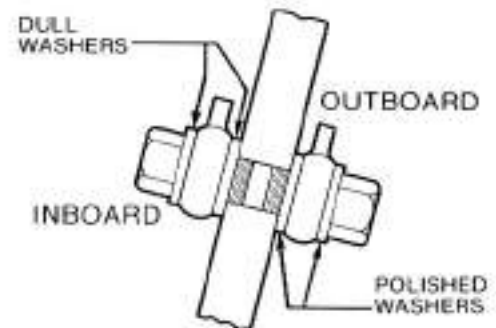

When you install the hydraulic hoses, use polished washers, outboard, and dull washers, inboard. The polished cadmium-plated washers protect the bolts from premature corrosion.

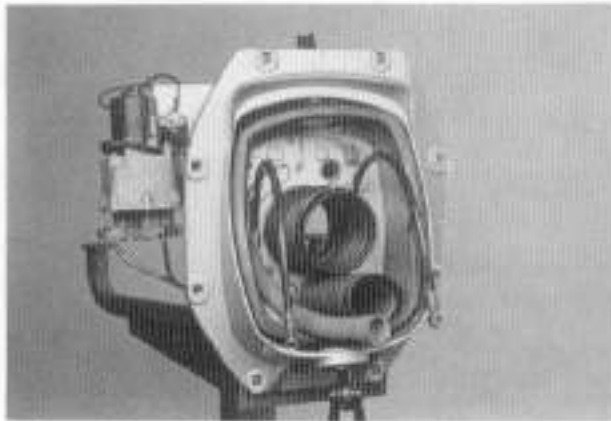

### Exhaust Boots Installed

The final step in preparing the transom shield is to put the U-joint and exhaust boots in place. The U-joint boot must be positioned with the extra ridges facing down so the boot can flex completely when the stern drive unit is fully tilted up. The U-joint screw clamp must face up, and the exhaust boot clamp must face down.



### Attaching Boot Rib

To insure proper fit, it is important that the boot rib be popped into the proper position on the engine tail shaft and stern drive collar.

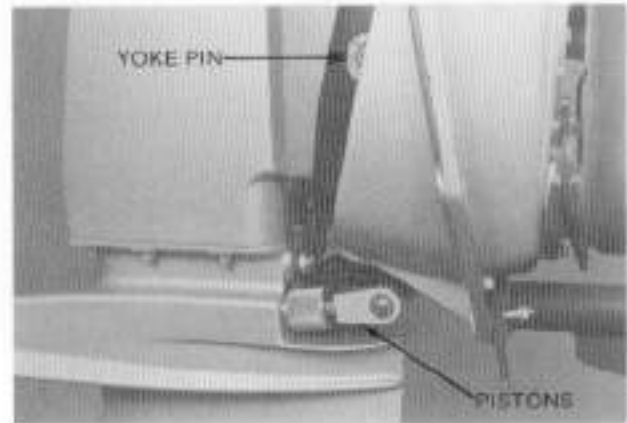

### Attaching Stern Drive to Shield

The stern drive unit is attached to the transom shield by pins on either side of the steering yoke and at the trim/tilt pistons.



### Sending Unit Cover

A sending unit for the trim/tilt system is part of the starboard side yoke pin. The cover of this sending unit must be precisely adjusted for proper trim/tilt indication. Consult the BMW stern drive installation manual or a BMW Marine dealer for installation instructions.

## V12 ENGINEERING

428 Second St. Kenora  
Ontario Canada  
P9N 1G6

Ph: 1-807-543-3003

[bmwmarine.com](http://bmwmarine.com)

<https://www.boat-manuals.com/>

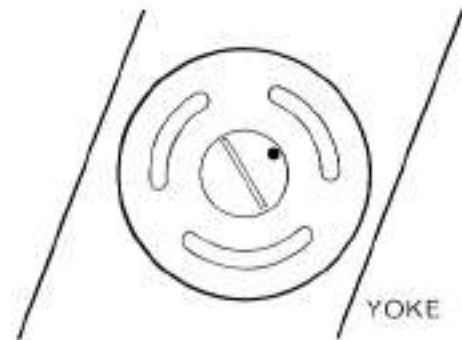
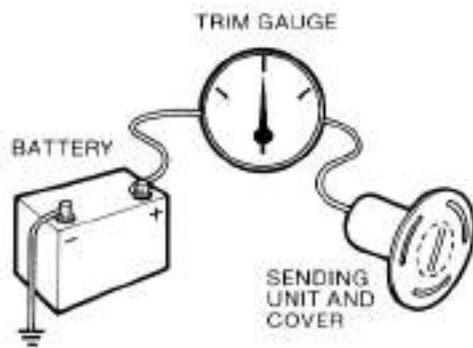

Then, install the sending unit into the steering yoke with the mark in the same position, and place the cover on the sending unit. This procedure makes precise adjustment of the trim sender easier.

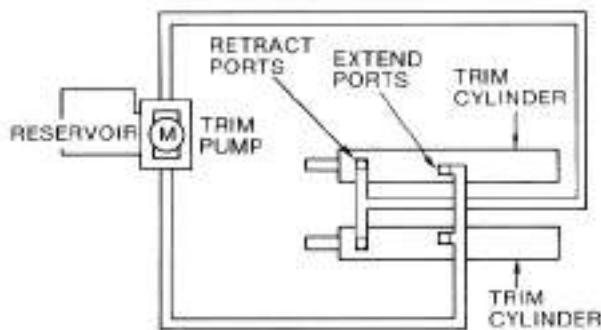

To make accurate adjustment of the sending unit easier, follow this procedure. First, wire the sending unit, trim gauge, and a battery together. A detailed wiring diagram for this is shown here.

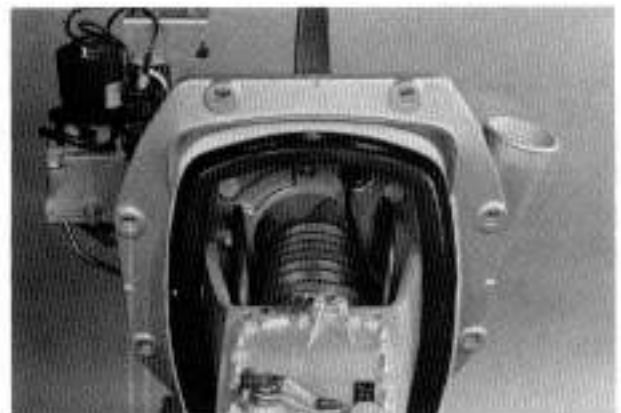

#### Mounted Stern Drive Unit

Check these points in your mounted stern drive unit: U-joint boot screw clamps face up, exhaust boot clamps face down, and the flexible hydraulic lines drape within the steering yoke.

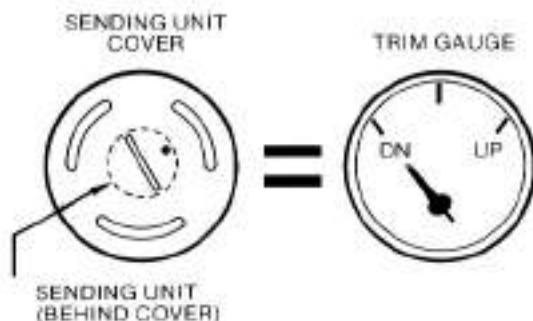

Second, place the sending unit cover on the sending unit, hold the cover, and turn the sending unit until the trim gauge indicates the "fully down" position. Note the position of the mark on the front of the sending unit.



## BMW Stern Drives

- Introduction
- Installation
- **Maintenance**

Built-in quality makes BMW stern drive maintenance simple. Aside from physical inspection, checking and changing oil in the stern drive and trim/tilt system, and adjusting the stern drive shift cable, no other maintenance is normally required.



### Shift Cable Adjusted

Once the stern drive is installed, the shift cable must be attached and adjusted. Be sure the cable collar rests securely in its bracket. The stern drive cover holds the collar in place.

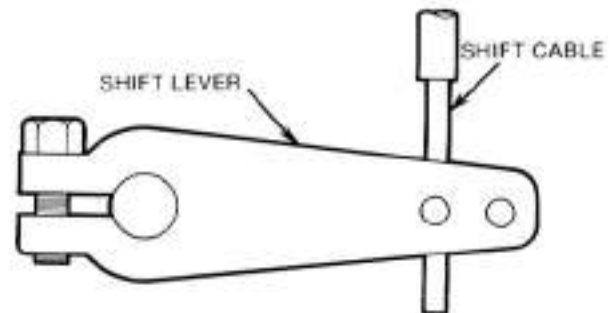

Position the cable end in the shift lever as shown. For best operation, be sure the cable end is always placed in the inside hole on the shift lever.

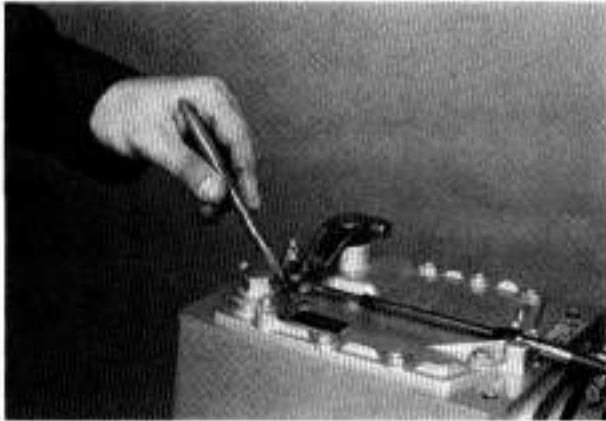

### Lining Up Shift Lever

With the boat shift control in neutral, adjust the cable end so the shift lever lines up with the raised line on the stern drive housing.

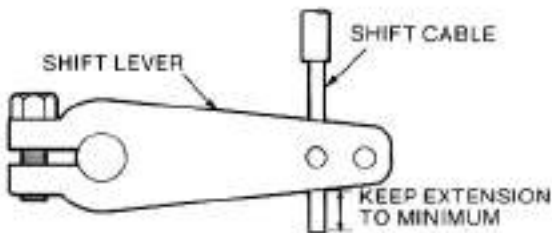

Be sure the cable does not extend too far past the lever. If it does, it might interfere with the stern drive cover during operation. If necessary, adjust the cable at the boat shift control lever.



### Adjusting Trim Tabs

To lessen steering torque, both the Mark I and Mark II stern drives have adjustable trim tabs. To adjust the trim tab, loosen the trim tab nut using a 17mm box end wrench and turn the tab. The BMW Marine Stern Drive Owner's Manual explains trim tab adjustment in more detail.

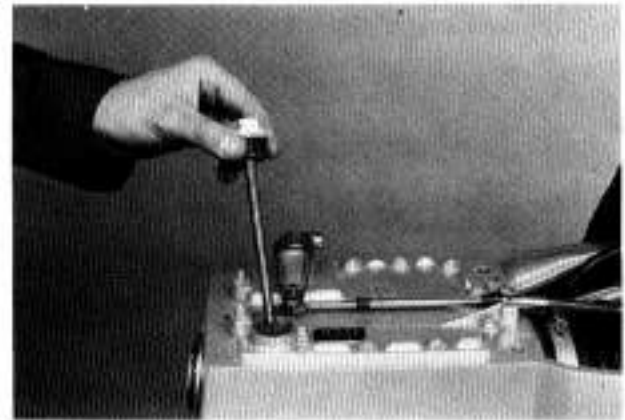

### Checking Oil Level

Be sure to check the stern drive oil level regularly. The dipstick is on top of the stern drive and is marked for minimum and maximum oil levels. Use only the preferred Type F (Ford) automatic transmission fluid or DEXRON ATF in the stern drive.

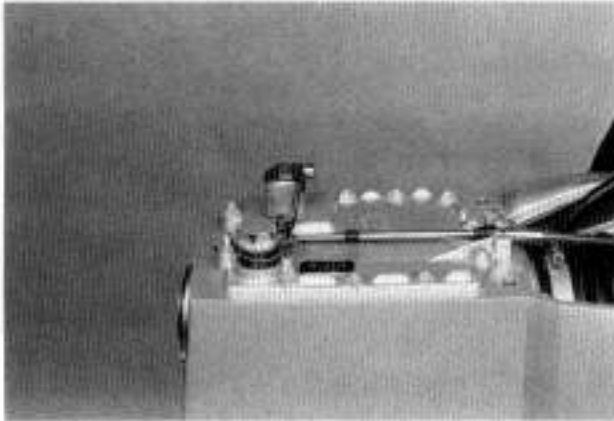

### Dipstick Unscrewed for Check

To check the oil level, insert the dipstick, but do not screw it in. Check the stern drive oil level only when the boat engine is not running.

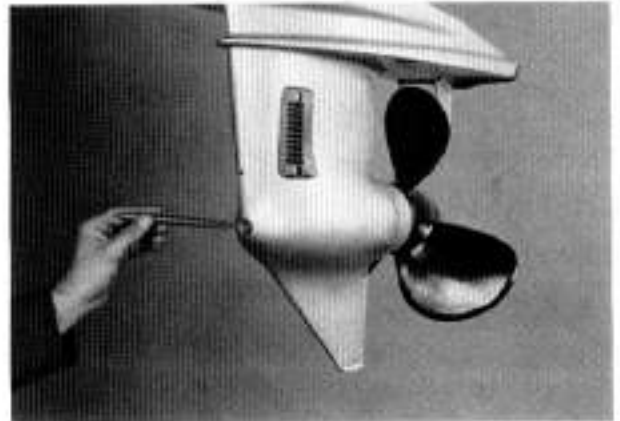

### Mark I Oil Drain Plug

The oil in the stern drive should be changed before each boating season. The oil drain plug on the Mark I stern drive is on the *front* of the drive unit.

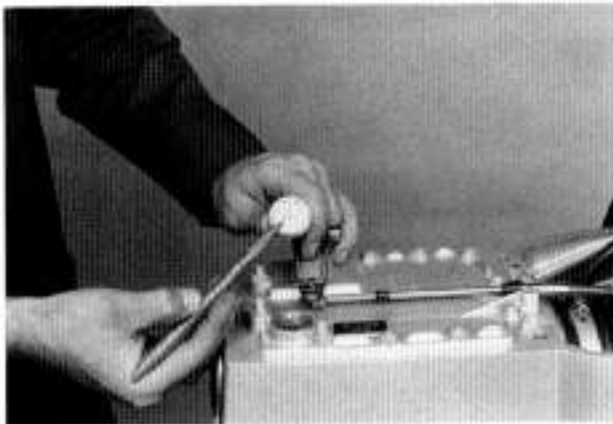

### Dipstick with "X" Stamp

Check that the dipstick provided with your Mark I stern drive has an "X" stamped on it. If it does not, see your BMW dealer. Dipsticks without an "X" are provided on Mark II drive units.



### Mark II Oil Drain Plug

On the Mark II, the oil drain plug is on the *rear* of the stern drive near the prop. Make certain all old oil is completely drained from the stern drive before adding new oil. Both the Mark I and Mark II units hold 6.8 U.S. quarts of transmission fluid, if *completely* drained.



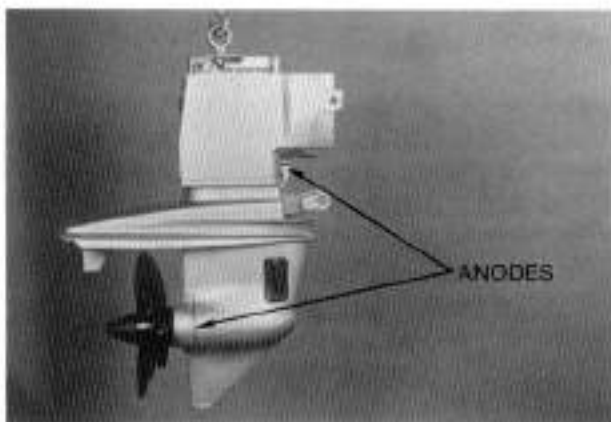

### Mark I Corrosion Protection

For superior protection against corrosion, BMW builds sacrificial zinc anodes into each stern drive. The anodes corrode so the stern drive does not. On the Mark I, one anode is near the trim/tilt pistons. The prop collar is the other anode.

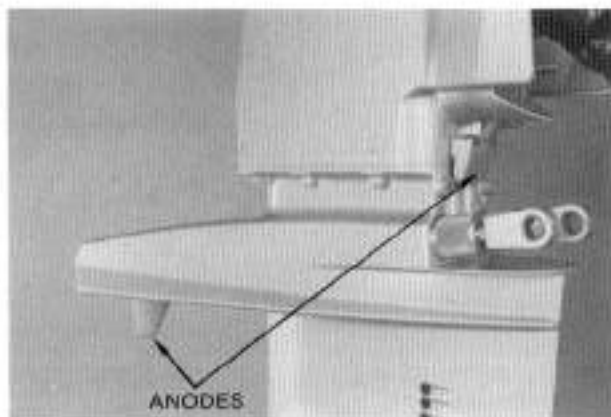

### Mark II Corrosion Protection

The Mark II uses the same anode near the trim/tilt pistons. Instead of the prop collar, however, the trim tab serves as the other anode. Check the anodes regularly and replace any that are more than half eaten away by corrosion.

## Inspect Hoses and Boots

- Loose?
- Damaged?
- Screw Clamps?

As you inspect the anodes, also check the condition of all rubber hoses and boots. Replace damaged boots, and replace all boots and screw clamps before each boating season.

## Inspect Prop

- Nicked?
- Bent?
- Dented?

Check the prop condition, too. The prop must be free of any nicks or dents. For best performance, be sure none of the blades are bent. Replace a damaged propeller immediately.



### Hydraulic Fluid Fill Plug

For increased protection, reliability, and dependability, the trim/tilt system is built into the stern drive, rather than being attached externally. Be sure to check the hydraulic fluid level of the system regularly. There are two oil plugs in the system—a vent plug and a fill plug. The fill plug is the lower of the two.



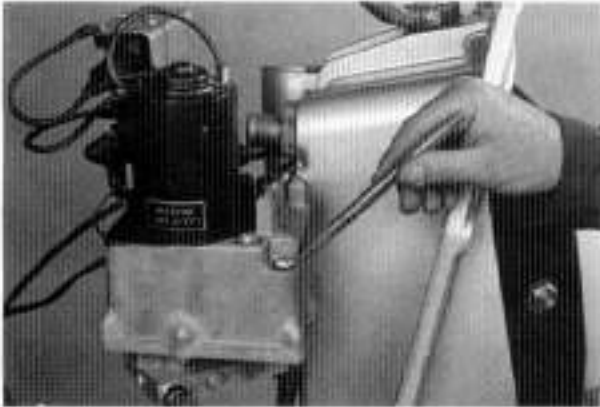

### Removing Fill Plug

To fill the reservoir, remove the fill plug and be sure to check that the vent plug is already open. Fill the reservoir with Type F transmission fluid to the threads in the fill plug hole. Replace the fill plug and operate the system through several complete cycles to bleed air from it. Then, top off the oil level again. Be sure to tighten only the fill plug after bleeding the system. Make sure that the vent plug remains open.



### Touch Up Paint

Touch-up paint is available from your BMW Marine dealer to prevent corrosion and to keep your BMW stern drive looking like new.

## Check Often

- Screw Clamps
- Exhaust & U-joint Boots
- Oil Levels

To get the best performance from your BMW stern drive, the position and tightness of the screw clamps, the condition of the exhaust and U-joint boots, and the oil level in the stern drive and trim/tilt system should be checked regularly.

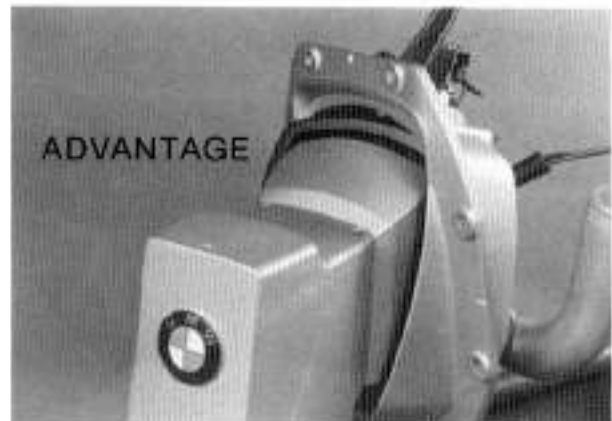

BMW stern drives, quality construction and superior engineering. Together, they give you the BMW Marine advantage.



# Special Tools

## Mark I and Mark II Stern Drives











Figure	Tool Name Part Number	Mark I	Mark II
	CLUTCH SHAFT HOLDER  74 64 1 330 936	•	
	ALIGNMENT TOOL KEYWAY  74 64 1 330 937	•	•
	SPANNER CLUTCH SHAFT NUT  74 64 1 330 938	•	•
	REMOVER  74 64 1 330 939	•	•
	INSTALLER BUSHING  74 64 1 330 940	•	•
	SPANNER BEVEL GEAR NUT  74 64 1 330 941	•	•



Figure	Tool Name Part Number	Mark I	Mark II
	SPANNER DRIVE SHAFT NUT  74 64 1 330 942	•	•
	BUSHING  74 64 1 330 943	•	
	PRESS-IN MANDREL  74 64 1 330 944	•	•
	SQUARE PROFIL  74 64 1 330 969	•	•
	DISTANCE BUSHING PROP. SHAFT GEAR  74 64 1 330 970		•

V12 ENGINEERING

428 Second St. Kenora  
Ontario Canada  
P9N 1G6

Ph: 1-807-543-3003

# Stern Drive Electrical System

## Trim/Tilt System Wiring Diagram

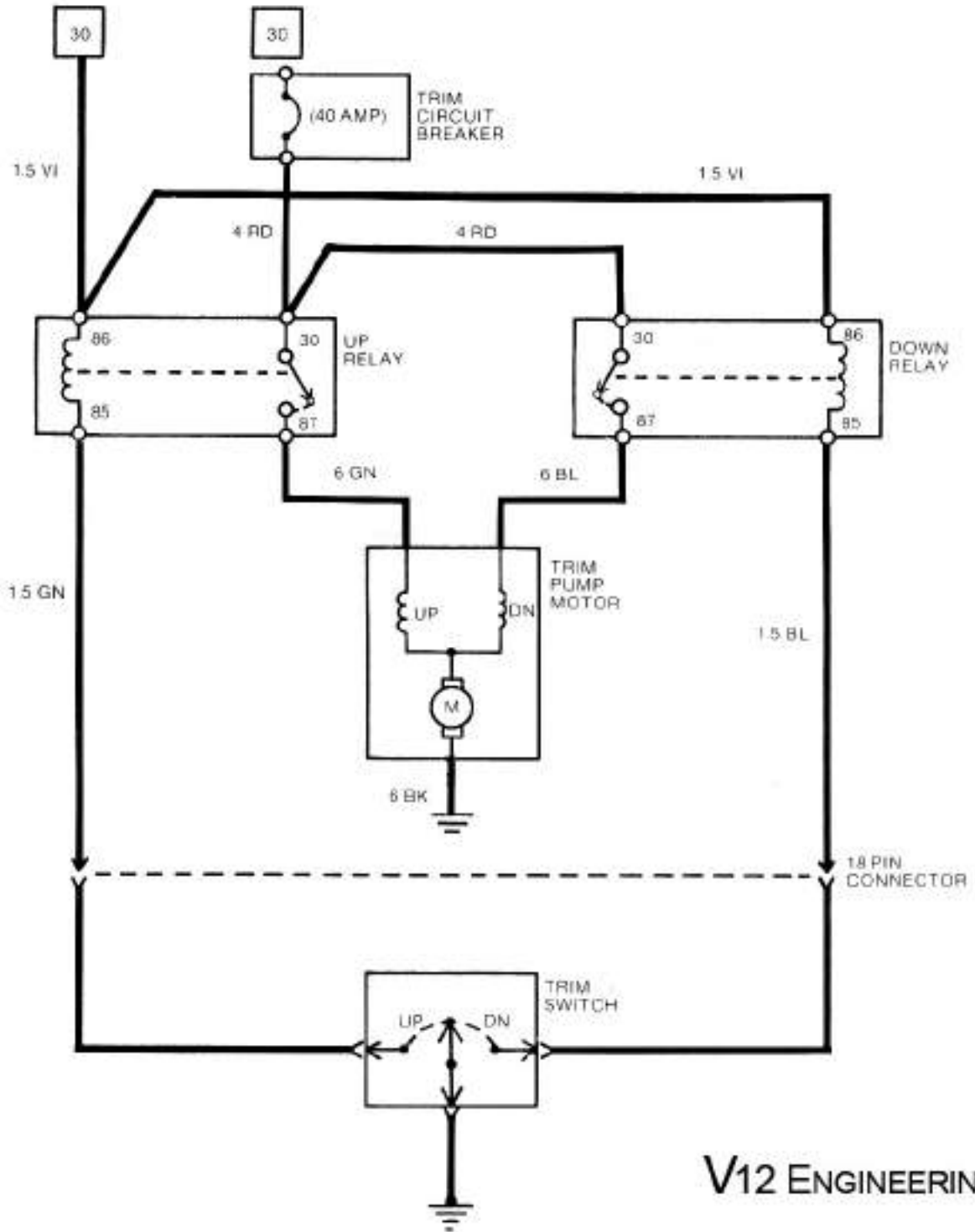

V12 ENGINEERING

428 Second St. Kenora  
Ontario Canada  
P9N 1G6

Ph: 1-807-543-3003



# Trim/Tilt Indicator Wiring Diagram

## MOTOMETER

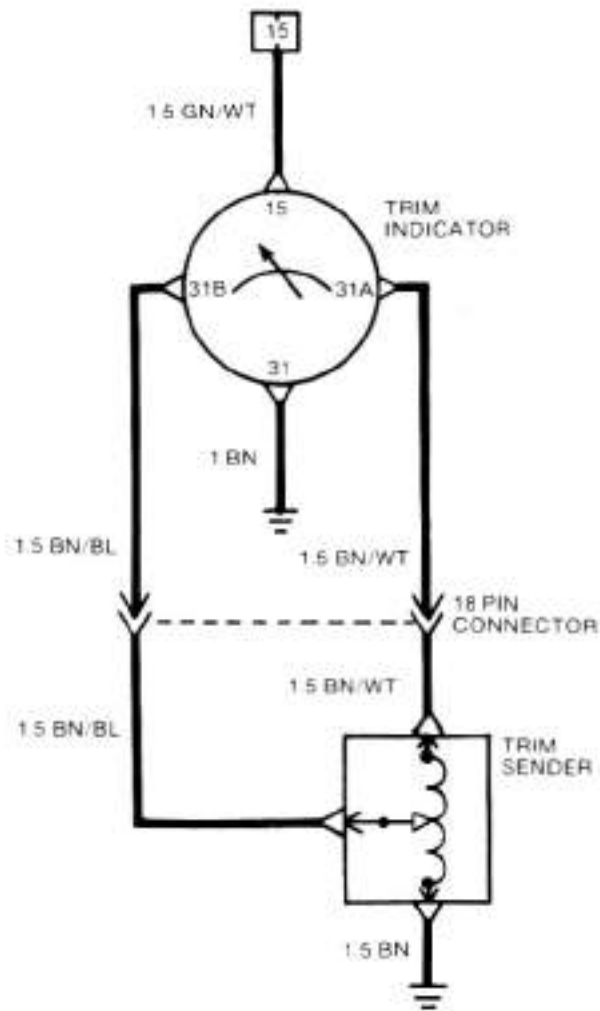

## VDO

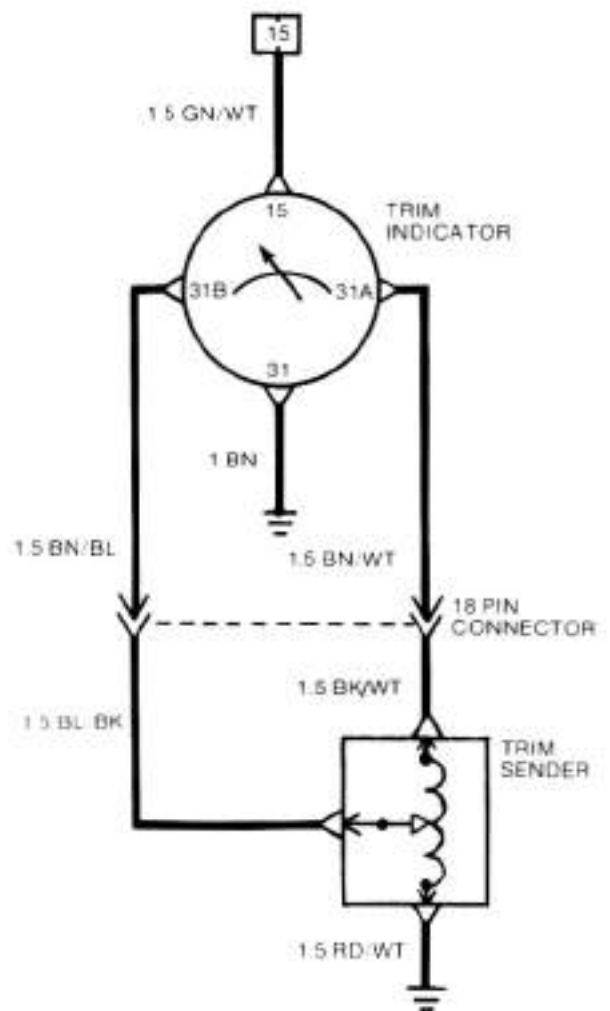

<p>CAVITY NUMBER</p> <p>4 FEMALE CONTACT</p> <p>GROUND REFERENCE NUMBERS ARE PROVIDED FOR GROUND LOCATION ON THE ENGINE</p> <p>G100</p>	<p>MALE CONTACT</p> <p>CONNECTOR REFERENCE NUMBERS ARE PROVIDED FOR CONNECTOR LOCATION ON THE ENGINE.</p> <p>C103</p>	<p>CONNECTOR IS ON COMPONENT WIRES (PIGTAILED)</p> <p>WIRE SIZE (MM<sup>2</sup>) AND INSULATION COLOR ARE PROVIDED FOR EACH WIRE.</p> <p>2.5 GN</p>	<p>WIRE COLOR CODE</p> <table border="0"> <tr><td>RD</td><td>RED</td></tr> <tr><td>BK</td><td>BLACK</td></tr> <tr><td>GN</td><td>GREEN</td></tr> <tr><td>BR</td><td>BROWN</td></tr> <tr><td>YL</td><td>YELLOW</td></tr> <tr><td>WT</td><td>WHITE</td></tr> <tr><td>BL</td><td>BLUE</td></tr> <tr><td>VI</td><td>VIOLET</td></tr> </table>	RD	RED	BK	BLACK	GN	GREEN	BR	BROWN	YL	YELLOW	WT	WHITE	BL	BLUE	VI	VIOLET
RD	RED																		
BK	BLACK																		
GN	GREEN																		
BR	BROWN																		
YL	YELLOW																		
WT	WHITE																		
BL	BLUE																		
VI	VIOLET																		

# Stern Drive Hydraulic System

## Trim/Tilt Hydraulic System

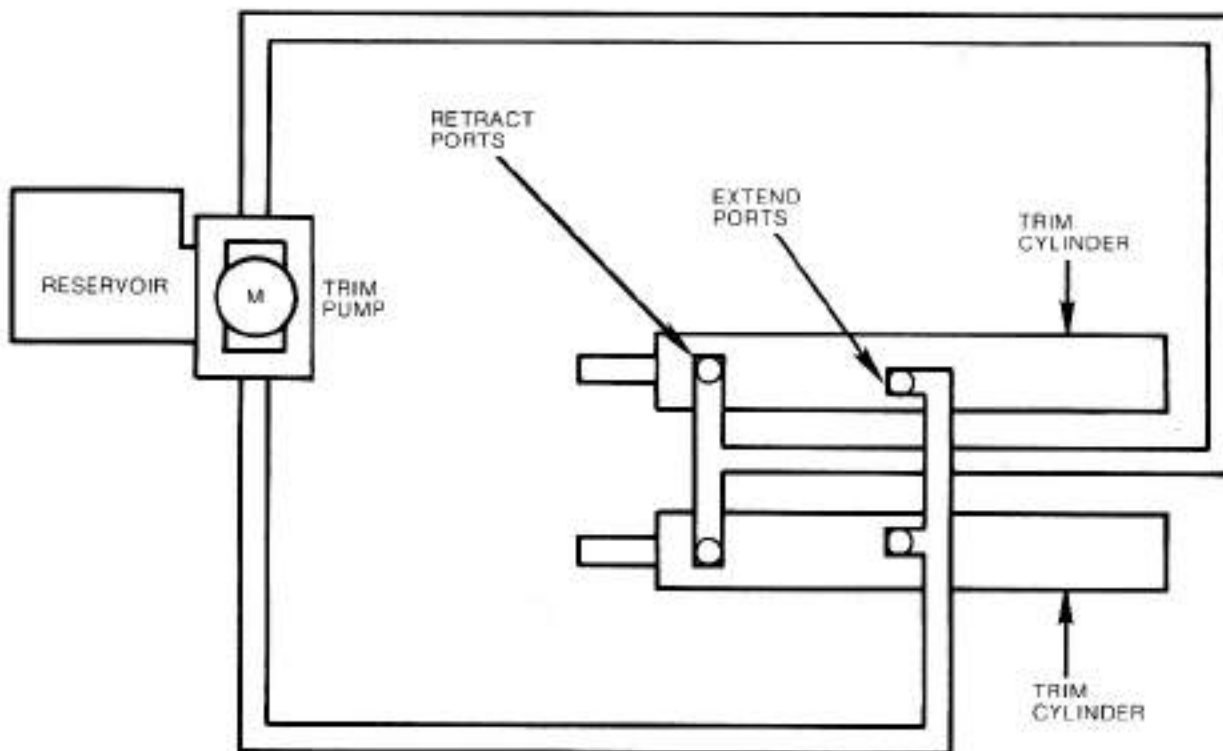

V12 ENGINEERING

428 Second St. Kenora  
Ontario Canada  
P9N 1G6

Ph: 1-807-543-3003

[bmwmarine.com](http://bmwmarine.com)

# Specifications



<b>Lubrication</b>	
Oil Capacity Oil Type	6.8 U.S. quarts transmission fluid ATF Type F (Ford) preferred, or DEXRON ATF

<b>Gear Reduction Ratios</b>	
1.61 to 1	D150/D190 Engines
1.95 to 1	G190/G220 Engines
2.2 to 1	G130 Engine

<b>Torque Values</b>	
Upper Cover Screws	15 ft lbs
Piston Rod Pivot Pin Lock Screws	15 ft lbs
Trim Tab Lock Screw	30 ft lbs
Sacrificial Anode	15 ft lbs
Shift Cover to Upper Gear Housing	15 ft lbs
Upper Gear Housing Studs	Loctite 270

**V12 ENGINEERING**

428 Second St. Kenora  
Ontario Canada  
P9N 1G6

Ph: 1-807-543-3003

# Notes

---





# Notes

---



**V12 ENGINEERING**

428 Second St. Kenora  
Ontario Canada  
P9N 1G6

Ph: 1-807-543-3003

**bmwmarine.com**



**BMW MARINE**

---

## V12 ENGINEERING

428 Second St. Kenora  
Ontario Canada  
P9N 1G6

Ph: 1-807-543-3003

[bmwmarine.com](http://bmwmarine.com)

