

Workshop Manual

BMW D7

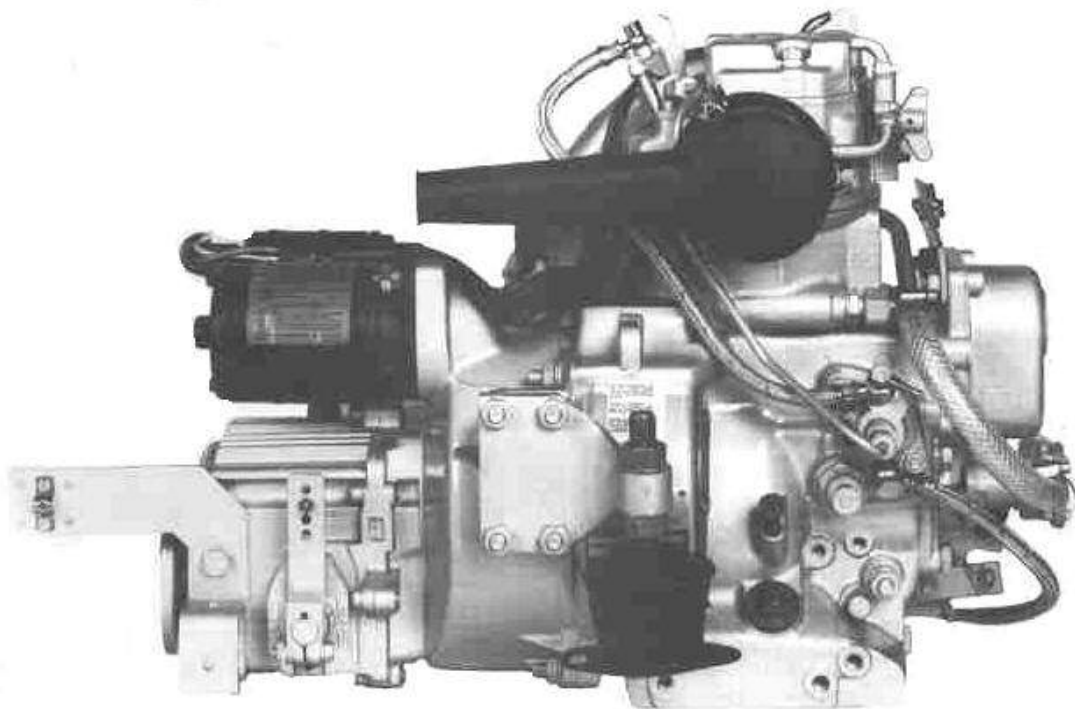

BMW Marine

This copy of the BMW D7 Workshop Manual has been re-created using images computer scanned from a manual rather than original artwork.

<https://www.boat-manuals.com/>

BMW D7 Marine Engine

A four-stroke diesel engine with direct injection and open-circuit cooling system. The Neoprene impeller of the coolant pump is driven directly from the crankshaft. Electric starter and flywheel alternator are standard equipment. The injection system is fitted with automatic bleeding.

Notes on Use

This workshop manual describes complete procedures for dismantling, overhaul and assembly of the BMW D7 marine engine.

If only part of the procedure is to be carried out (e.g. small repairs or replacement of gaskets, oilseals) the remainder can be ignored.

The relevant technical data is provided with each section. General specifications are found on page iii.

Assembly is generally a reversal of removal procedure. Special attention, however, should be paid to "notes on assembly".

Checking and adjustment procedures, where applicable, are to be found at the end of the relevant section.

	Page		Page
Introduction	i	Fuel System	27
Summary	1	Remove, adjust:	
Removing cylinder head	3	- Injection valve	27
- Preparations	3	- Injection pump	29
- Valve mechanism	4	- Engine speed	31
- Valves	5	Check:	
- Cylinder head	7	- Injection pump	32
- Cylinder	7	- Injection valve	32
		- Fuel pump	32
Removing gearbox	8	Air filter	33
- Starter	8	Electrical system	34
- Reversing gear	8	- Wiring diagram	34
- Bearing cover	9	- Generator	35
- Hand crank mechanism	10	- Starter motor	39
- Connecting rod	11	Water Pump	40
- Piston	13		
- Fuel pump	14		
- Timing gear cover	14		
- Fuel regulator	15		
- Crankshaft	16		
- Valve lifters	19		
- Camshaft	20		
Assemble crankshaft	20		
- Camshaft	20		
- Crankshaft	20		
- Fuel regulator	21		
- Timing gear cover	21		
- Fuel pump	21		
- Piston	21		
- Connecting rod	21		
- Hand crank mechanism	21		
- Bearing cover	22		
- Reversing gear	22		
- Starter	22		
Assemble cylinder head	22		
- Cylinder	22		
- Cylinder head	23		
- Valves	23		
- Valve mechanism	23		
- Hoses & pipes	23		
Adjust:	24		
- Valve clearance - valve timing	24		
- Decompression lever	25		
- Automatic decompression	26		

Technical data

Capacity	280cc / 17.1 cu.in.
Bore x stroke	73 mm x 67 mm / 2.87 in x 2.64 in
Max. power	4.5 kw / 6 bhp @ 3600 rpm
Compression ratio	22 : 1
Dry weight with gearbox	68 kg / 150 lbs
Gearbox reduction	forward 2.7:1, reverse 1.9:1
Max. installation angle	15°

Specifications

Fuel	Diesel oil, DIN 51601/USA #2
Lubricating oil, engine	HD-API CC/CD
gearbox	Hurth ATF Dexron - ZF SAE 20 W 20
Oil capacity, engine	2 litres / 3.5 pints UK / 4.4 pints US
gearbox	0.4 litres / 0.7 pints UK / 0.85 pints US
Fuel filter	BMW 13 32 1 328 270
Air filter	BMW 13 71 1 329 269
Injector	Bosch
Injection pressure	135 + 8 bar
Injection pump	Bosch PFR 1 K 70 A 343/II
Starter motor	Bosch 0.8 kw
Generator	14V 350W 25A
Battery	12V 60 Ah
Gearbox	Hurth HBW5 - ZF Bw 3

Adjustment data

Injection ends	11.5° - 12.5° BTDC
Valve clearances, cold	0.15 mm / .006 in.

Torque settings

	Nm	kpm	Remarks
Cylinder head nuts M 8	40	4.0	Use permanently elastic sealing compound (e.g. Atmosit) on the stud screws in the oil space!
Connecting rod screws	40	4.0	Oil threads and screw head insert lightly
Counter weight screws	22	2.2	Oil threads and screw head insert lightly
M 6 hex nut for the mounting of the injector	10	1.0	
Flywheel bolts M 10	70	7.0	
Injection pump delivery valve	40	4.0	
M 6 hex head screw for fastening bearing cover retaining yoke on the flywheel side	10	1.0	
Nozzle nut	85	8 - 9	

List of Special Tools D7

BMW Part No.	Description
74 64 1 333 525	To refit ball hub
74 64 1 333 526	To refit crankshaft gear
74 64 1 333 513	Crankshaft installation tool
74 64 1 333 514	Puller for valve lifter shaft
74 64 1 333 515	Tool for crankshaft removal
74 64 1 333 516	Tool for camshaft needle bearing installation
74 64 1 333 517	Wrench for injection adjuster
74 64 1 333 527	Crankshaft gear puller
74 64 1 333 535	Tool for adjustment of injection pump
74 64 1 333 528	Tool for injection adjuster
74 64 1 333 536	Multi purpose extractor
74 64 1 333 529	Auxiliary wrench for cable connector
74 64 1 333 530	Sleeve 27 - 36 mm internal extractor
74 64 1 333 531	Counter support-internal extractor
74 64 1 333 537	Allen socket with center pin 8 mm
74 64 1 333 538	Allen socket with center pin 10 mm
74 64 1 333 539	Clamping holder to grind valve-valveseat
74 64 1 333 540	Allen wrench 6 mm elongated
74 64 1 333 518	Auxillary bush-oil seal
74 64 1 333 519	Punch - needle bearing camshaft
74 64 1 333 520	Socket 13 mm (long size)
74 64 1 333 541	Allen socket 6 mm
74 64 1 333 521	Retaining bracket for cylinder
74 64 1 333 542	Press-in mandrel-valve guide 7 mm Ø
74 64 1 333 532	Hand reamer 7 mm Ø H 7 for valve guide
74 64 1 333 543	Flare nut wrench 17/19 mm
74 64 1 333 522	Special tool for governor spring
74 64 1 333 523	Box wrench 10mm
74 64 1 333 524	Piston ring clamp
74 64 1 333 544	Measuring device for bumping clearance
74 64 1 333 545	Testing device for injection equipment
74 64 1 333 546	Dial gauge 1/100 mm
74 64 1 333 547	Torque wrench 1 - 140 NM
74 64 1 333 534	Guiding pin 7 mm Ø (valve reseating tool)
74 64 1 333 548	Handle for valve reseating tool
74 64 1 333 549	Piston ring pliers
74 64 1 333 550	Allen socket 8 mm
74 64 1 333 551	Valve reseating tool 42.5 mm Ø
74 64 1 333 552	Gudgeon pin extractor

BMW Marine Diesel Engine D7

Description:

Water cooled single cylinder four stroke producing 4.5 kW (DIN) (6 Hp)

1. Cylinder head cover
2. Decompression lever
3. Throttle cable mount
4. Hand crank attachment
5. Cover
6. Sea water pump
7. Fitting
8. Hose clips
9. Sea water hose
10. Engine mounts
11. Cylinder head
12. Metering device

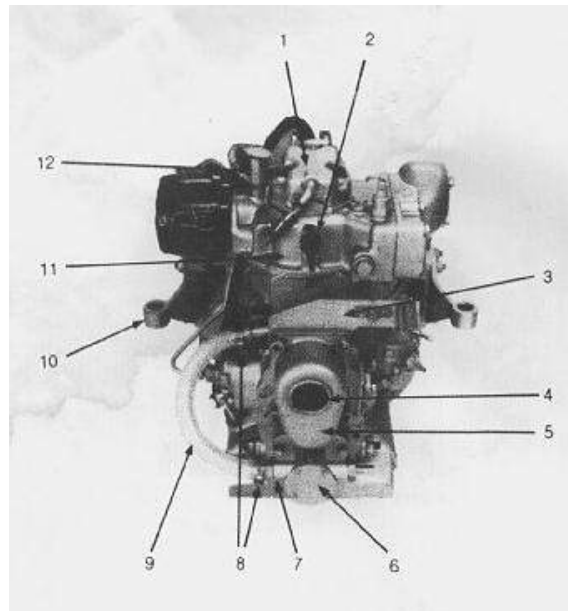

13. Fuel return hose
14. Injector
15. Air filter
16. Fuel injection pipe
17. Injection pump
18. Throttle
19. Dipstick
20. Oil filler screw

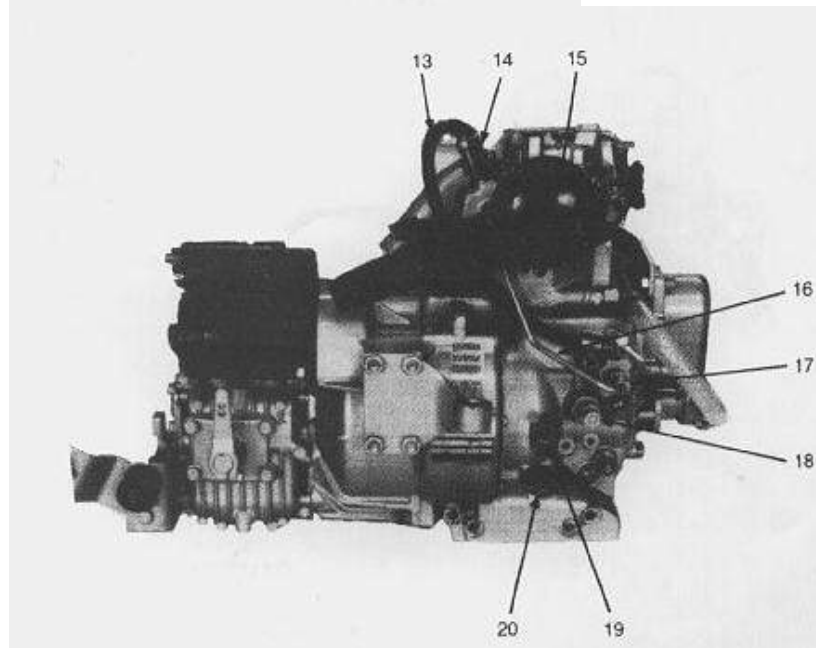

- 21. Exhaust
- 22. Starter
- 23. Retainer yoke
- 24. Gear box
- 25. Crankcase
- 26. Fuel pump
- 27. Fitting
- 28. Sea water pipe

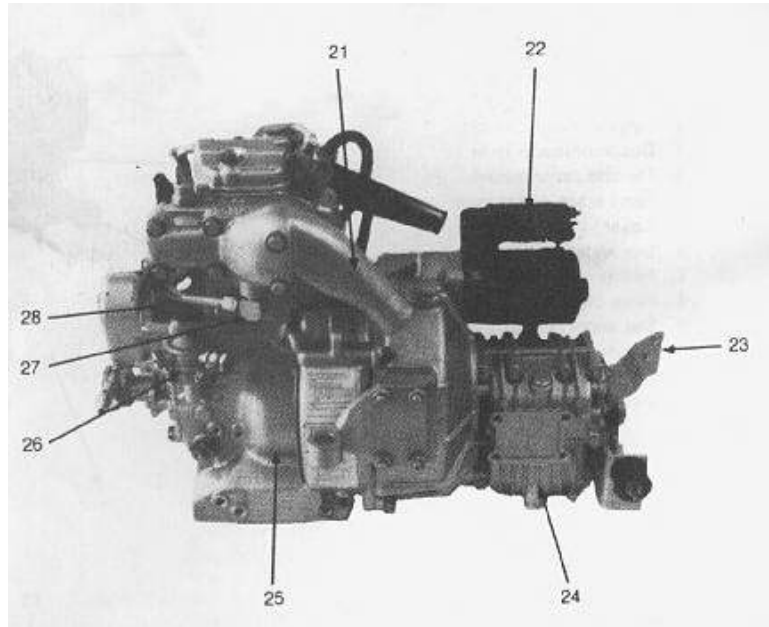

CAUTION

To avoid damage to engine parts, always use special tools as shown in the illustrations. The tools to be used fit only in the position shown.

Removing cylinder head and cylinder

- Remove air filter (1)
- Loosen sea water pipe from exhaust manifold and water pump and remove (2) + (3)

CAUTION

Cover all openings in the fuel system

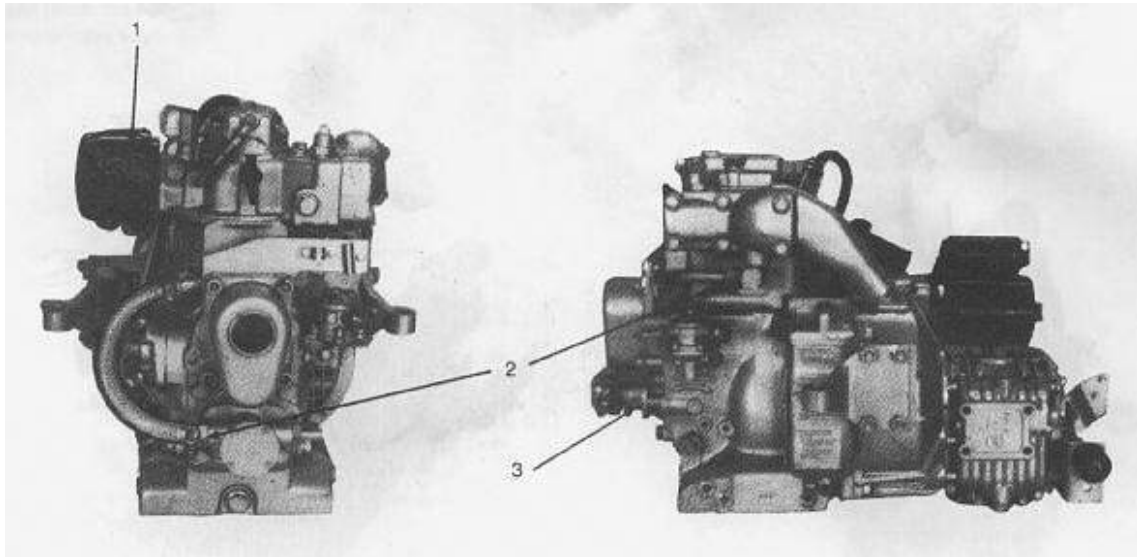

- Disconnect fuel return hose from injector and remove (4)
- Disconnect fuel injection pipe from injector and injection pump and remove (5)
- Remove clip of crankcase vent hose (6), unscrew both nuts of the rocker cover and remove the rocker cover with gasket (7)

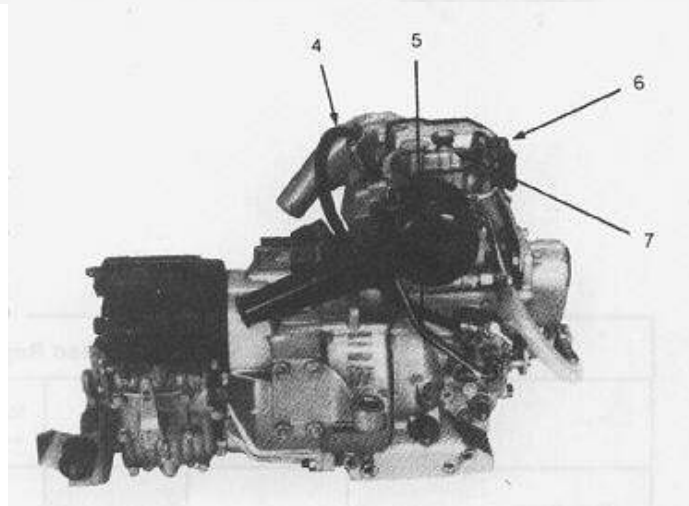

Detach
Disassemble
Remove

Air filter, seawater hose, fuel overflow hose, cylinder head vent hose clip, cylinder head cover with gasket, rocker shaft with rockers, pushrods

Cylinder Head

- Remove rocker shaft with bushing and retainer yoke and remove rockers (8) and (9)
- Pull out both pushrods

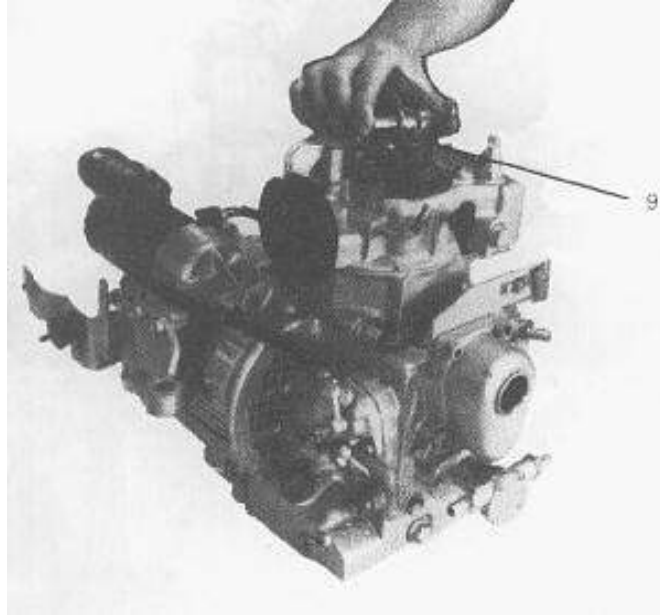
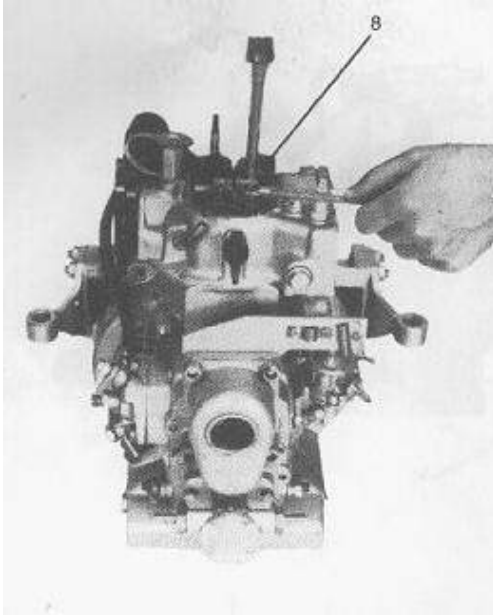

Cylinder Head Repair Data				
	Dimension	D7 nominal values	Max. allowable wear (mm)	Remarks
Rocker arms shaft dia.	mm	18 -0.027	0.05	After press fitting
Rocker arm internal dia.	mm	18 $+0.024$ $+0.006$	0.05	
Rockaer arm radius	mm	8	No flats	
Valve seat angle	°	45		

Detach
Disassemble
Remove

Rocker shaft with rockers, pushrods

- Remove decompression lever from the underside of the cylinder head (10)
- Unscrew the M10 nut and unscrew stud bolt.
- Remove the spring
- Remove retaining pin with pointed pliers
- Unscrew inner clamping sleeve on gear segment and remove shaft and gear segment.
- Remove valves & valve springs (11)
- Press down the spring retainers

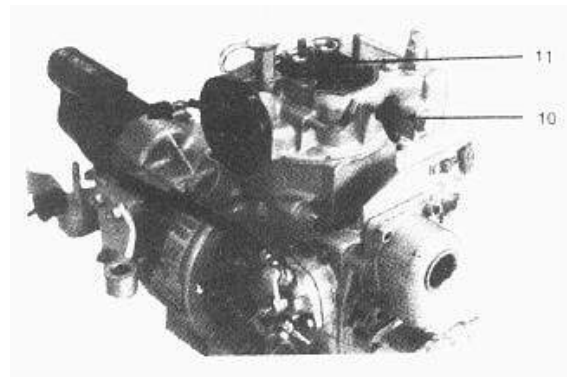

WARNING

Danger of injury due to spring retainers and valve keys popping out.

- Loosen both key halves while applying pressure from below and remove with pointed pliers.
- Remove cap and washer from under the valve spring
- Remove valve
- Press out the valve guides from below

NOTE

When pressing in the new valve guides, when parts are cold note minimum force of 1000 N (approx 100 kp)

- Ream the valve guides
- Rework leaky valve seats with a 45° valve seat cutter. Mill only enough to remove spots from valve seats.
- Reseat valves using auxiliary tool
- No 74 64 1 333 539

Detach
Remove
Rework

Decompression lever handle, clamping sleeve on handle, spring shaft,
valve poppets, spring plate with valve spring, cone halves, valve guides

Cylinder Head

The valves should sit back as measured from the seating surface of the cylinder head, according to the following table:

Repair Data Valves				
Cylinder Head	Dimension	D7 nominal values	Max. allowable wear (mm)	Remarks
Valve clearance cold	mm	0.15		
Intake valve stem dia	mm	7 $\begin{smallmatrix} -0.04 \\ -0.05 \end{smallmatrix}$	0.05	
Exhaust valve stem dia	mm	7 $\begin{smallmatrix} -0.05 \\ -0.04 \end{smallmatrix}$	0.05	
Intake valve disc dia	mm	30.5		
Exhaust valve disc dia	mm	30.5		
Valve sit back max	mm	0.70		CAUTION! Valve sit back may not be less than 0.45 mm as otherwise the danger exists that the valve disc hits the piston.
Valve sit back min	mm	0.45		
Valve guide bore	mm	7 $\begin{smallmatrix} +0.09 \\ 0 \end{smallmatrix}$		
Outer diameter	mm	10 $\begin{smallmatrix} +0.023 \\ +0.029 \end{smallmatrix}$	0.05	The sealing surface of the cylinder head can be reworked to a maximum of 0.5 mm if the sit back of 0.7 mm is exceeded due to valve seat milling.
Valve guide bore in cylinder head	mm	10 $+0.0011$		
Valve guide press in force	kp	100		
				With the cylinder head cold.

Table: Valve sit back

Remove cylinder head and pull off cylinder (12)



The cylinder head is unusable in the following cases:

- Sealing surface fouled or damaged i.e. uneven
- Clean the sealing surface and re-grind, observing the tolerances
- Valve seats worn out or no longer suitable for re-facing.
- Cracks in the valve seats in the cylinder head

NOTE

Measure cylinder bore with a cylinder indicator

In the following cases, the cylinder is unusable:

- Seize marks are found in the bore
- Scratches are present
- Wear exceeds 0.15 mm

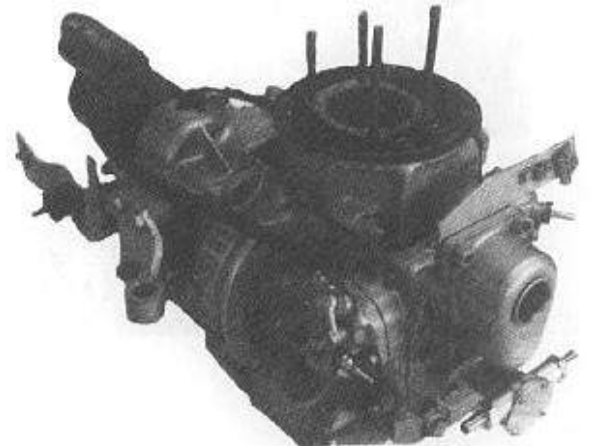

Repair Data Cylinder				
Cylinder	Dimension	D7 nominal values	Max. allowable wear (mm)	Remarks
Bore dia	mm	73 + 0.01	0.15	
Roughness Ra	μ	1.0 – 1.2		
Oversizes	mm	+ 1		

Remove Unusability of cylinder head/cylinder
 Detach Cylinder head, cylinder

Remove starter (13)

- Remove attaching clamp of the cable to the stator and remove starter
- Remove the four cylinder screws M 10 and remove the flywheel (15) and (16)

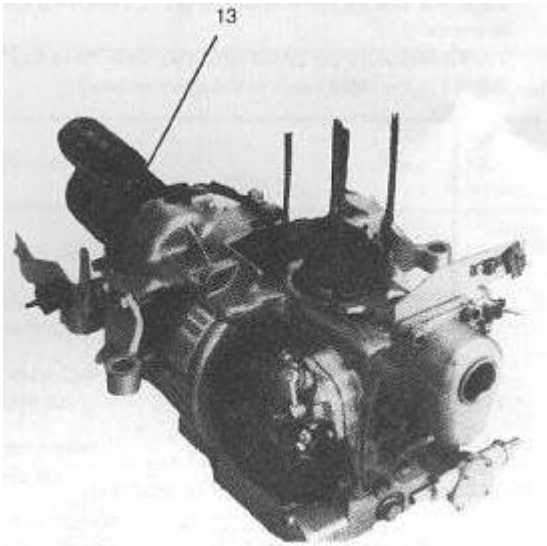

Remove gearbox (14) complete with flywheel cover.

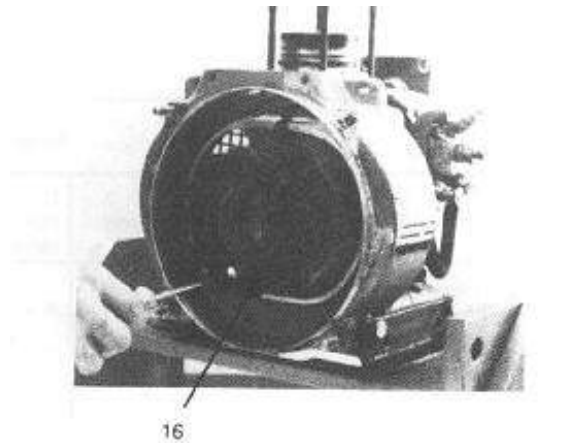
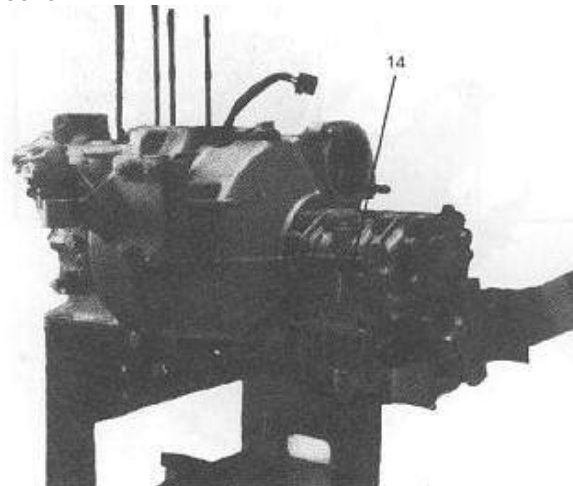

Remove bearing cover
Detach

NOTE

- After loosening the four M6 hex screws, remove the bearing cover with locking plate and the sealing ring located on the inner face (17)

Bearing cover can be replaced when the engine is cold

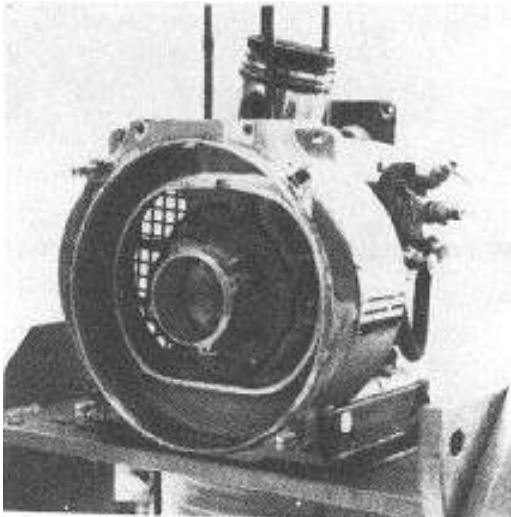

- Remove screws from cover of timing gear cover and take off the cover (18)

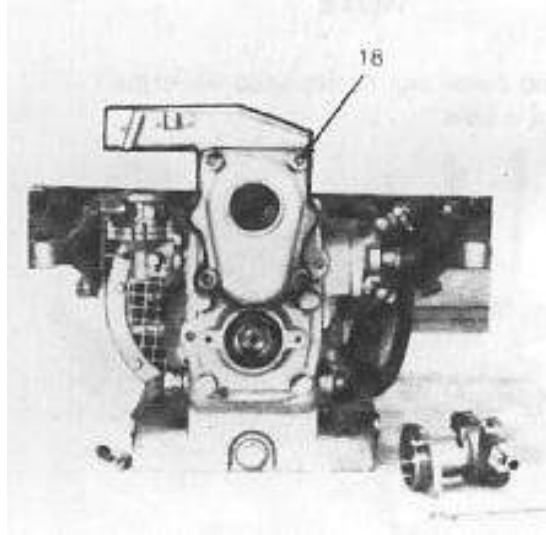

- Remove hand crank mechanism (19) with extractor tool No 666 332 00

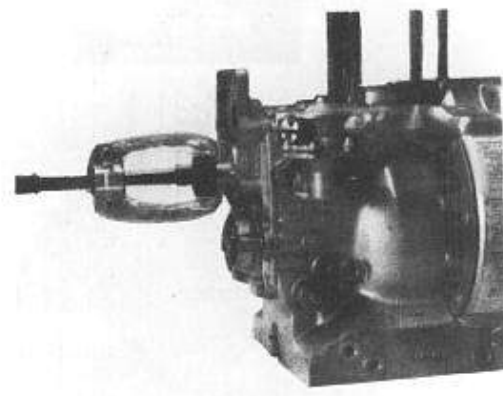
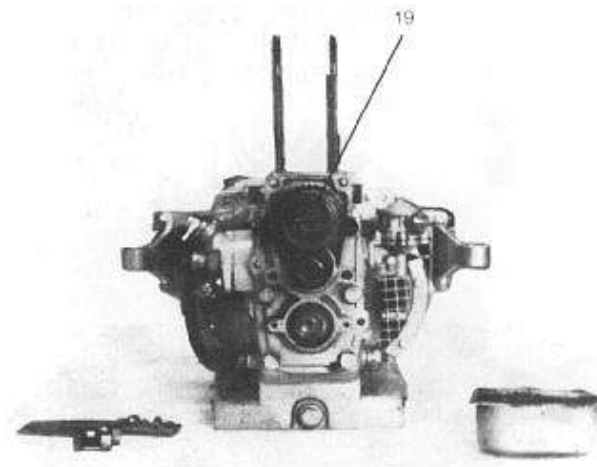

Detach Cover of timing gear cover, hand crank device, dipstick, cover on engine bottom,
Remove connecting rod

Dipstick / cover on engine bottom / connecting rod

- Turn the engine on to the flywheel side (23) and remove dipstick (24)

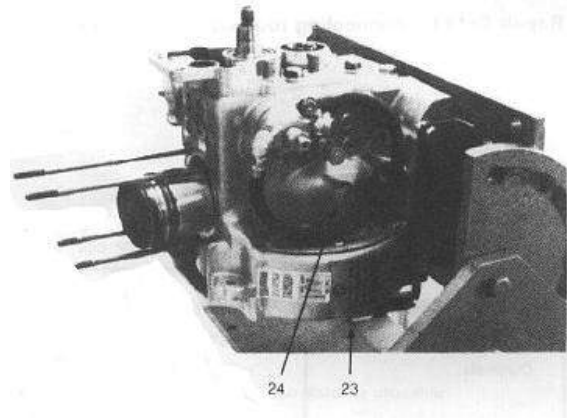

- Remove cover and O-ring from crankcase on the engine bottom (25).

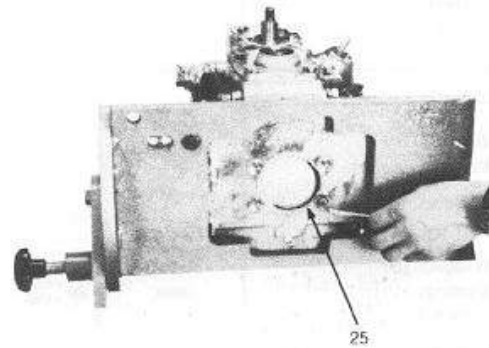

- Unscrew the two connecting rod screws (26).
- Take out connecting rod cap with oil pick-up (27) from below and piston and connecting rod (28) from top.

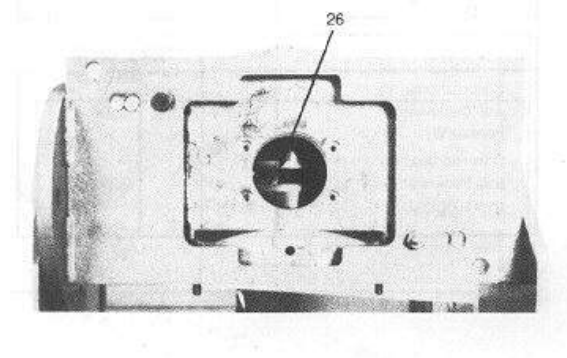
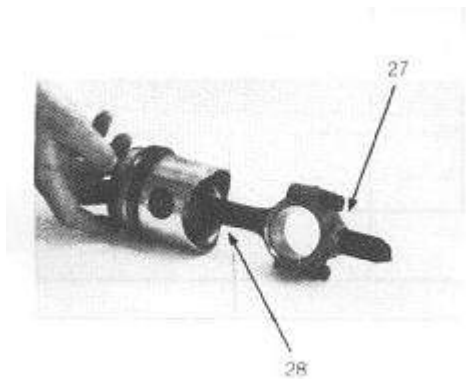

Detach
Remove

Dipstick / cover on engine bottom / connecting rod

Table: Repair data for connecting rod and connecting rod bearing

Repair Data for con-rod bearing and con-rod				
Con-rod bearing	Dimension	D7 nominal values	Max. allowable wear (mm)	Remarks
Outer dia	mm	46		Minimum bearing play = 0.040-0.076mm when new max wear to 0.15mm Total play after wear: max 0.15mm
Inner dia	mm	42 ^{+0.016} _{-0.026}	see table on page 17	
Width	mm	26.5		
Undersize	mm	41.5	see table on page 17	
Con-rod bearing wall thickness normal(W)	mm	1.998 ^{+0.02}		
Con-rod bearing wall thickness oversize(WU)	mm	2.248 ^{+0.02}		
Con-rod				
Gudgeon pin bushing bore dia	mm	28 ^{+0.013} ₀		0.20
Con-rod bearing bore dia	mm	46 ^{+0.010} _{-0.006}		
Gudgeon pin bushing: outer dia	mm	28 ^{+0.048} _{+0.035}		
inner dia – loose	mm	25 ^{+0.082} _{+0.068}		
- installed	mm	25 ^{+0.020} _{+0.007}		
Thread con-rod bolts		M8		

Note

Heat piston to remove piston pin

- Remove the gudgeon pin snap rings and press out the gudgeon pin by hand while the parts are still warm (29).

In the following cases, the piston is unusable:

- ring land between the rings broken
- piston scuffed
- ring groove worn out
- and cracked

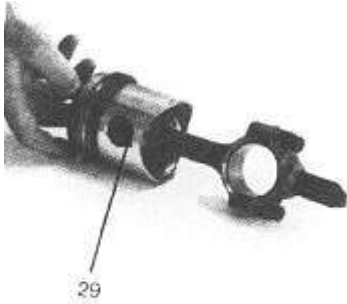

Piston rings are unusable when the gap is too big

Repair Data				
Piston	Dimension	D7 nominal values	Max. allowable wear (mm)	Remarks
Piston dia	mm	72.96		
Oversize	mm	+1.00		
Overall length	mm			82mm
Piston ring gap (new condition)	mm	0.25 – 0.4	Up to 2.00	

Unscrew Piston
Detach

- Remove fuel pump (29a)

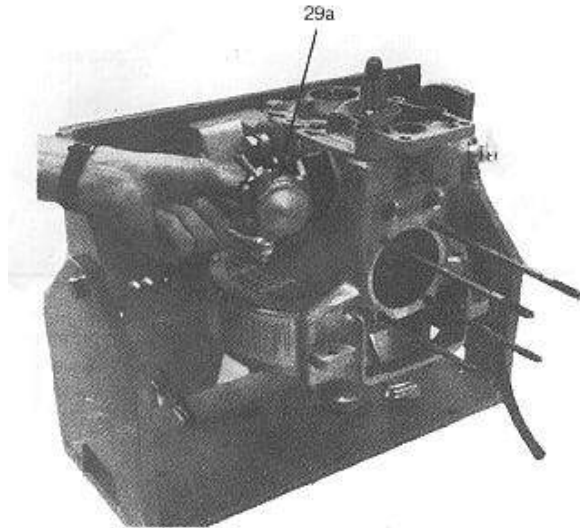

- Remove pump plunger (29b)

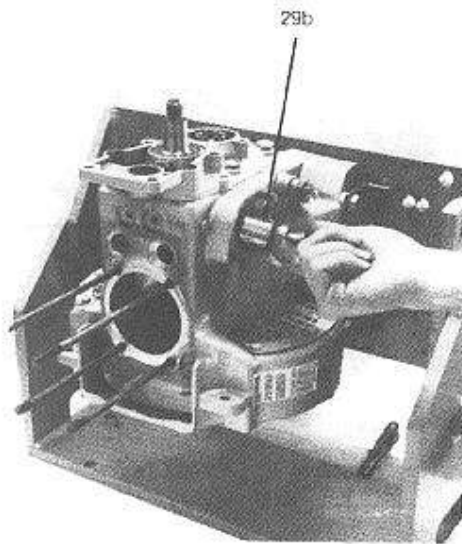

- Unscrew the three M16 hex nuts and remove timing gear cover (29c)

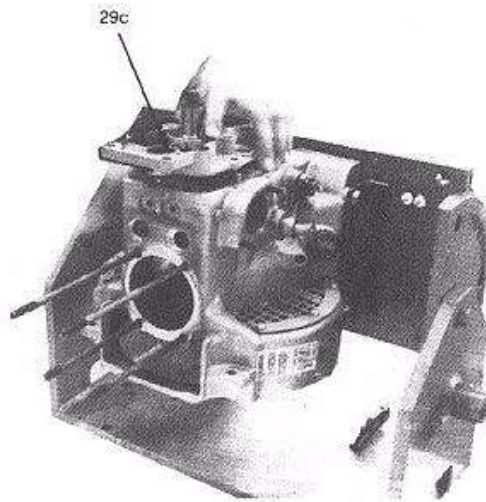

Detach Fuel pump, pump plunger, timing gear cover
Remove

Fuel regulator, gear on crankshaft

- Bring engine into the horizontal position, as shown in Fig (29d)
- Remove gear from crankshaft using extractor tool (29k)
- Loosen M6 hex nut (29f) on the regulator lever and pull out locking pin with pointed pliers
- Unscrew both M10 hex nuts (29e) from regulator shaft.
- Remove regulator shaft together with round nut, spring washer, sealing ring and friction disc.
- Unscrew M8 hex nut. Withdraw eccentric bolt with cap plate and sealing ring
- Loosen M20 hex nut. Remove start filling (29h) with sealing ring.
- Pull out clamping sleeve, using pointed pliers.
- Withdraw regulator lever with regulator spring (29i)
- Turn engine on flywheel side.

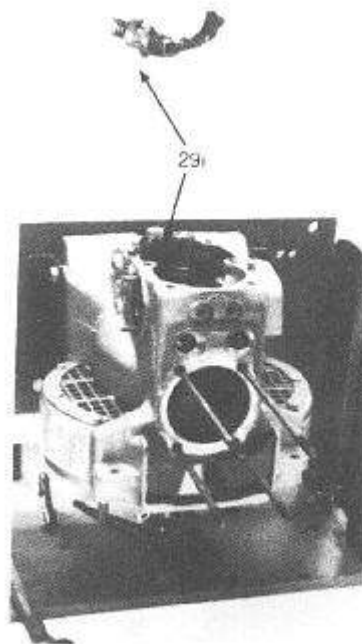
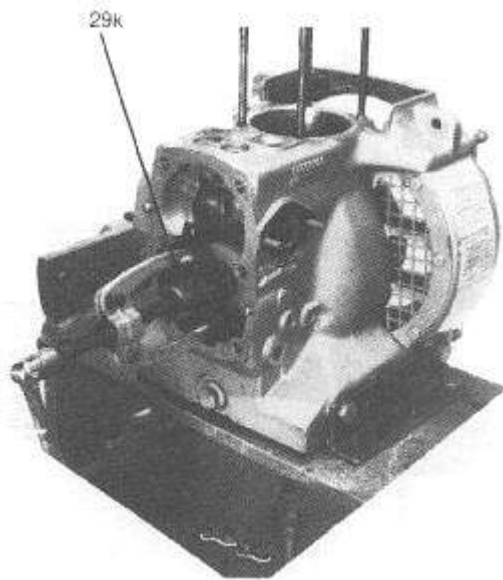
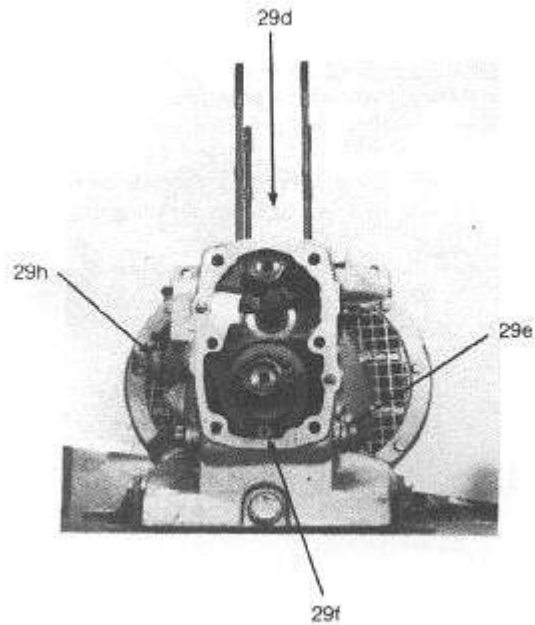

Repair Data for Regulator Spring Washers			
Maximum rpm	No of balls	Regulator Spring BMW Part No	Wire Dia
3600/160	4	13 41 1 329 652	2.6

Remove Regulator lever with regulator spring

- Remove ball sleeve with sliding disc taking care that no balls fall out (30)

Ball hub and spacer washer (31) remain on crankshaft. Detach these parts only when removing the crankshaft.

- Turn the engine block into the horizontal position.

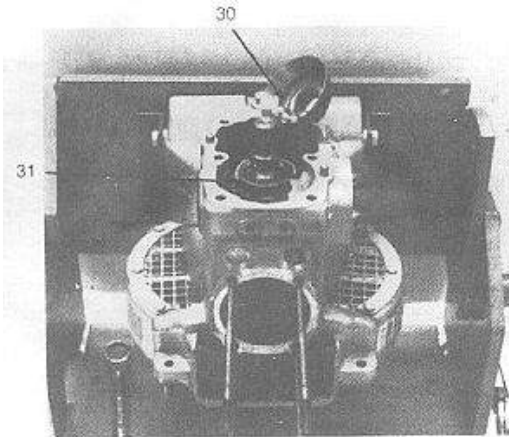

Removing the crankshaft

NOTE

It is essential that all plastic parts such as oil filler cover and cold start cover are removed

- Heat the crankcase on a heating plate to between 80 and 100° C (32)
- Press out the crankshaft with extractor tool (33) 74 64 1 333 515
- Press off the roller bearing on timing side (33a)
- Press off straight roller bearing together with spacer washer and drive dog hub (34)

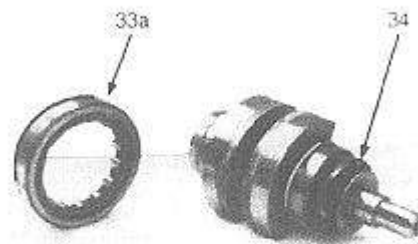
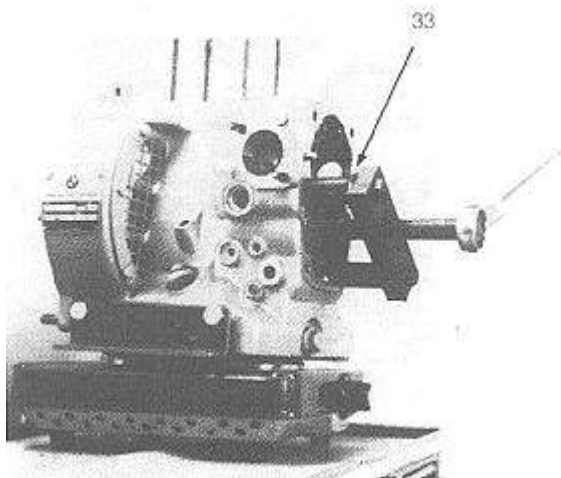
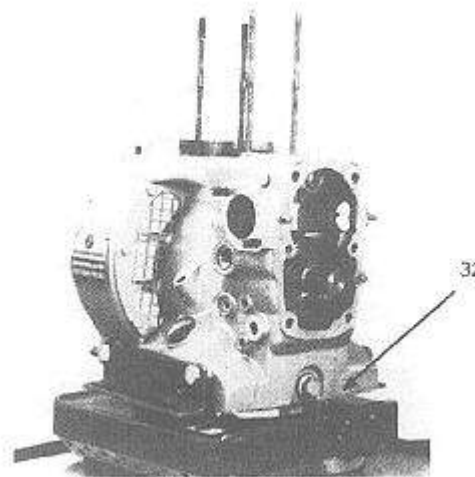

The outer race of the straight roller bearing on the timing gear side remains in the crankcase and can be removed with the aid of a press

In order to remove the bearing rings which have been shrunk on to the crankshaft (35) heat the crankshaft on a heating plate or with a sufficiently large gas burner rapidly to about 70 to 80° C

After removal of the M8 cylinder head screws, remove the counterweights (36).

Set the crankshaft on a solid support and loosen bearing race by a blow to the crankshaft.

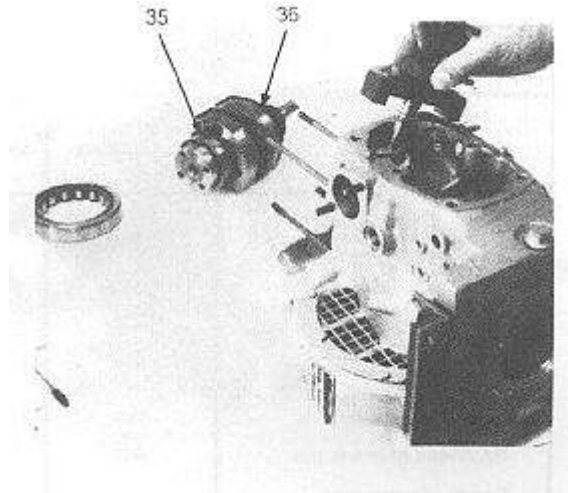

Repair Data for Crankshaft Crank Pins

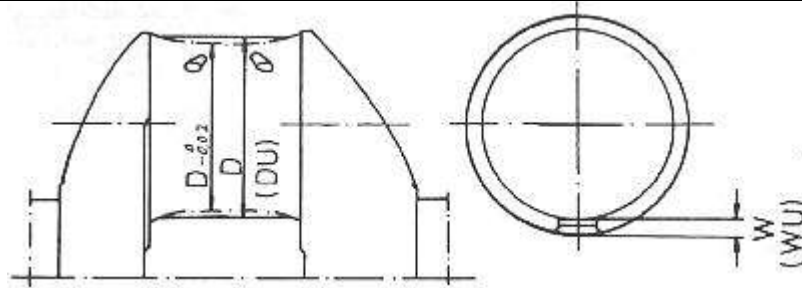

Crank pins must not become convex upon regrinding. A concave shape of from 0.01 to 0.02 mm in diameter in the mid portion of length is allowable.

Crank pin nominal diameter (D)	42	-0.060 $+0.074$	mm	Total play when worn out max 0.15mm
Crank pin diameter undersize (DU)	41.5	-0.060 -0.074	mm	

Table: Repair data for crankshaft

Repair Data for Crankshaft				
Crankshaft	Dimension	D7 nominal values	Max. allowable wear (mm)	Remarks
Crank pin dia	mm	42.0 $\begin{smallmatrix} -0.060 \\ -0.070 \end{smallmatrix}$	Total play 0.15 max	Max allowable crank pin out-of-round 0.05mm
End float	μ	0.3		
Crankshaft crank pin width	mm	33.0 $\begin{smallmatrix} +0.068 \\ 0 \end{smallmatrix}$		
Radii on crank pin	mm	3.0		
Hardness of crank pin	RC	50-55		
Depth of hardening of crank pin	mm	1.1-1.5		
Diameter of ball hub (regulator)	mm	29.0 $\begin{smallmatrix} +0.021 \\ 0 \end{smallmatrix}$		
Diameter of ball sleeve	mm	28.0 $\begin{smallmatrix} -0.020 \\ -0.041 \end{smallmatrix}$		
Diameter of gear on crankshaft	mm	22.0 $\begin{smallmatrix} +0.048 \\ +0.035 \end{smallmatrix}$		
Regrinding of crankpin	mm	0.5	Grinding finish see page 17	Hardness at least 48 RC
Axial play	mm	0.3-0.4		

Valve lifters and camshaft

- Remove the plastic plug from the side of the engine block (37)
- Unscrew the M8 set screw (38) with a 4 mm Allen key and remove together with plug

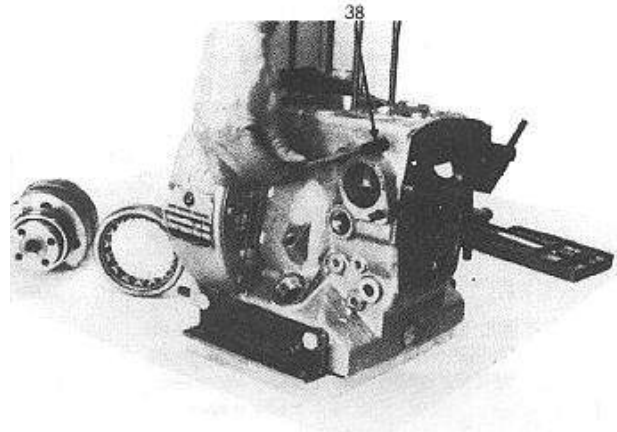
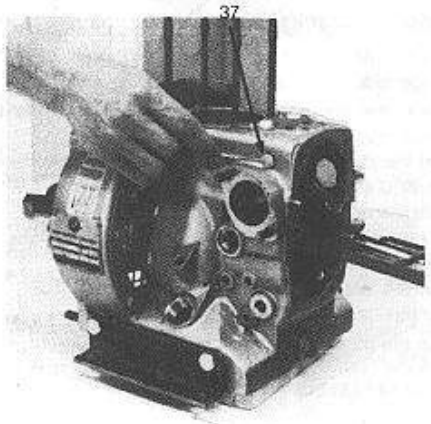

CAUTION

When removing the camshaft, lift off both rockers from the camshaft to prevent damage by the cam lobes

- Pull out valve rocker shaft with the aid of extractor tool No 74 64 1 333 514 (39)

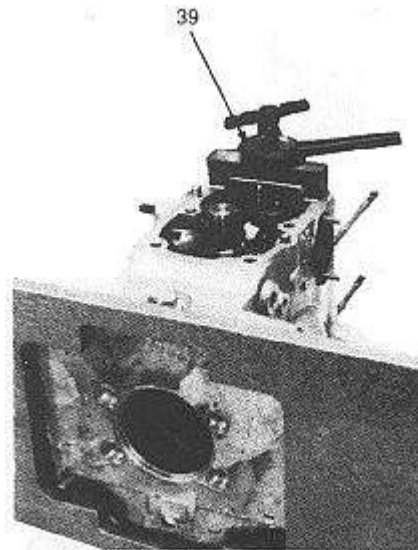

- Remove valve rockers together with washer (39b, 39c)
- Replace valve rockers if worn.
- Withdraw camshaft
- Press roller bearing off the camshaft
- Rotate crankshaft so that the needle bearing becomes accessible.
- A damaged camshaft needle bearing can be removed from the crankcase with drift punch No 74 64 1 333 519.

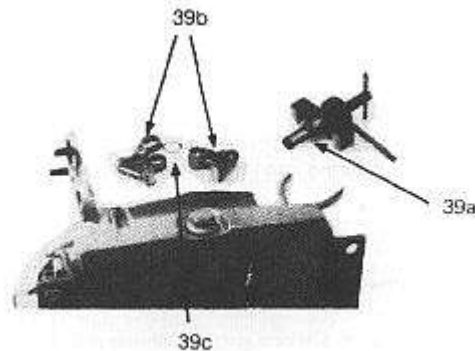

Remove Valve lifter shaft, valve lifters, camshaft, roller bearing

Reassembly of the engine parts is carried out in the reverse order.

NOTE

The tooth gear on the camshaft is marked with the letter "L". This indicates the direction of rotation of the engine as viewed from the front.

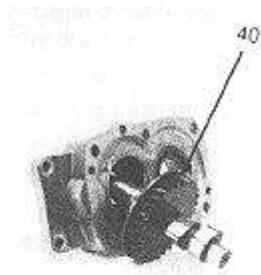

- Drive in the rear camshaft bearing using the assembly punch No 74 64 1 333 516.
- Install the camshaft.
- Screw in the set screw and replace the plastic plug.
- Insert the valve lifter shaft and tighten, so that the valve lifters show a minimum of axial play but are still free to move on the valve lifter shaft.

NOTE

Take care that the thrust washer is placed between the valve lifters and the crankcase to prevent the valve lifters from wearing into the aluminium case.

Installing the crankshaft

- Attach the counterweights, tightening the bolts to a torque of 2.2 kg/m (16 lb/ft)
- Heat the inner race of the roller bearing to between 70 and 80° C and mount on the crankshaft.
- Place the retainer ring on the outer bearing race.
- Push inner straight roller bearing onto the crankshaft together with spacer washer and drive dog hub.
- Heat the crankcase to between 100 and 150° C on a heating plate.
- Push the outer race of the bearing on the flywheel side onto the crankshaft and screw it on using special tool No 74 64 1 333 513



CAUTION

The crankshaft bearing is asymmetrical. The correct position is that shown in the illustration (41). The large rounding must be placed towards the outside, to ensure sufficient lubrication.

- Push the crankshaft with bearing into the heated crankcase from the flywheel side, until it reaches the stop of the special tool.

CAUTION

When installing the crankshaft, make sure that the axial play between the crankshaft and crankcase is between about 0.2 and 0.4 mm.

- Replace all plastic parts such as oil filter cover and cold start cover
- Turn the engine back onto flywheel side and place ball sleeve with sliding disc into position. Take care that the balls are inserted correctly.

- Set the engine block into the horizontal position
- Insert regulator lever and regulator spring
- Insert clamping sleeve into the regulating spring with pointed pliers
- Install start filling sealing ring and tighten M20 hex nut
- Install eccentric bolt with cap, plate and sealing ring.
- Insert regulator shaft and tighten both M10 hex nuts.
- Insert stop pin into the regulator lever and tighten hex nut.

Install gear on the crankshaft

- Before assembly, heat the cog for the crankshaft on a heating plate or in an oil bath to approx 80°C and assemble with tool No 74 64 1 333 526
- When mounting the cog onto the crankshaft, take care that the marking on the cog opposite the key groove points to the outside
- Turn engine block onto flywheel side.

When mounting the timing gear cover, adjust the cog on the camshaft and the cog on the crankshaft so that their markings are opposite each other.

Check upper dead center and overlapping.

- Mount the timing gear gear cover with light taps of a hammer and tighten both M16 hex nuts

NOTE

It is imperative that copper washers be used for the timing cover screws

- Insert pump tappet and mount fuel feed pump
- Before assembling the pistons, heat them on a hot plate. Insert gudgeon pin and the gudgeon circlips.
- Turn the piston ring gaps of the two piston rings and of the oil scavenge ring 120° to each other
- Lightly oil the threads and the screw head inserts of the connecting rod parts
- Insert the connecting rod bearing half with the hole into the connecting rod cap
- Insert the connecting rod bearing half without the hole into the connecting rod
- Assemble the connecting rod. Tighten the connecting rod screws with torque wrench and 6mm socket No 74 64 1 333 541 to torque of 40 Nm (4 kpm)

Install connecting rod in such a manner that the scoop is filled through the scoop opening when dipping into the lubricating oil. Scoop opening must point in running direction. The lubricating system is based on the centrifugal principle.

CAUTION

Set the cylinder slowly with great care onto the piston so that no piston ring is broken or damaged. Observe that the opening in the combustion chamber located in the piston crown points towards the flywheel side.

- Install crankcase cover with seal into the underside of the engine block
- Insert dipstick
- Turn engine block to the horizontal
- Assemble starting crank mechanism with extractor tool No 666 332 00
- Screw on the cover to the timing gear cover
- Mount bearing cover

CAUTION

In order to avoid damage to the bearing cover during assembly, use auxiliary bushing No 74 64 1 333 518

- Fill the groove in the bearing cover between packing washer and dust lip with ball bearing grease
- Mount the sealing ring on the inside of the holder, onto the holder with grease in order to prevent slipping during assembly.
- Insert the thrust ring into the dry bushing with the graphite coated side towards the outside.
- Mount the cog onto the camshaft without Woodruff key and tighten

NOTE

The marking of the cog on the camshaft must align with the Woodruff key groove.

- Coat the sliding surface of the dry bushing with molykote grease
- Insert the cog with needle bearing into the dry bushing
- Fill the housing with approx 100g of hot bearing grease e.g. "Calypsol WDT" or equivalent quality and assemble with gasket.

Install Regulator lever, regulator spring
Mount Regulator shaft, cog on crankshaft

Timing gear cover, connecting rod
Cover on crankcase, starting crank device,
cog on camshaft

- Fasten the stator in the crankcase and screw on the attaching clamp
- Install the flywheel. Tightening torque of the flywheel screws is 7.0 kpm
- Attach the reversing gear
- Attach the starter
- Adjust the gap with a corresponding cylinder foot gasket

The gasket set contains gaskets of various thicknesses.

NOTE

When installing the cylinder head pay close attention to the following points. It is imperative that a new cylinder head gasket be used and pay close attention to valve sit back and tightness

Tightness is checked by filling fuel into the intake or exhaust channel. If nothing leaks through, the valve seat is tight.

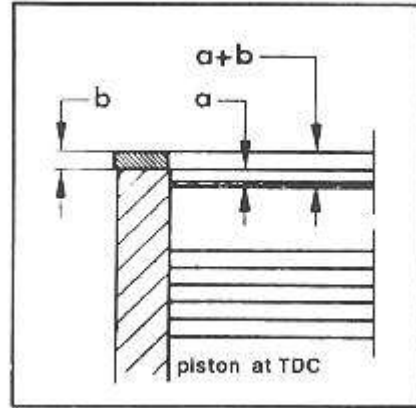

CAUTION

Do not damage the rubber sealing rings for the decompression lever, resp. decompression shaft and stop pin

After replacing cylinder, piston, connecting rod, crankshaft or crankcase, measure the gap between cylinder and piston upper surface at TDC (42).

Use the measuring bridge No 74 64 1 333 544 and clamping piece No 74 64 1 333 546 with measuring gauge, for measuring the gap.

- Mount the completely assembled cylinder head onto the cylinder
- Fasten the cylinder head with the aid of socket wrench No 6425 evenly and crosswise with the required tightening torque.

Tightening torque of the M8 hex nut on studs (tension rod) for the fastening of cylinder and cylinder head – 35 Nm (3.5 kpm)

NOTE

Oil threads lightly. However, do not use molykote. Seal locking screws in the oil space of the cylinder head with a permanently elastic sealing compound (e.g. Atmosit or similar)

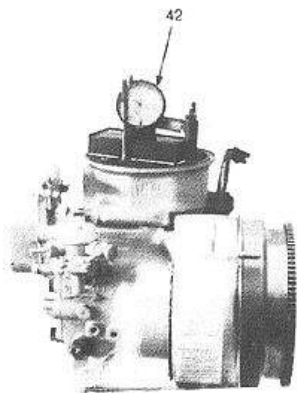

CAUTION

If the gap is too small piston, cylinder head and valves may be damaged. If the gap is too large, the engine loses performance.

Repair Data

Cylinder Head	Dimension	D7 nominal values
Piston gap (A)	mm	0.55 – 0.65
Cylinder head (b) gasket	mm	1.50
Cylinder shim	mm	0.1/0.2

Assemble Flywheel
Test Valve seat tightness, piston gap

Cylinder head

- Press in valve guides from underneath
- Insert valves
- Insert valve springs with cap and washer
- Insert spring plate
- Insert both valve keys, while applying counter pressure to the valve
- Insert shaft with gear segment and screw in internal clamping sleeve.
- Slide handle with ring onto the shaft and screw in external clamping sleeve.
- Insert push rods
- Insert rocker arms and assemble rocker shaft with bushing and retaining plate (43)

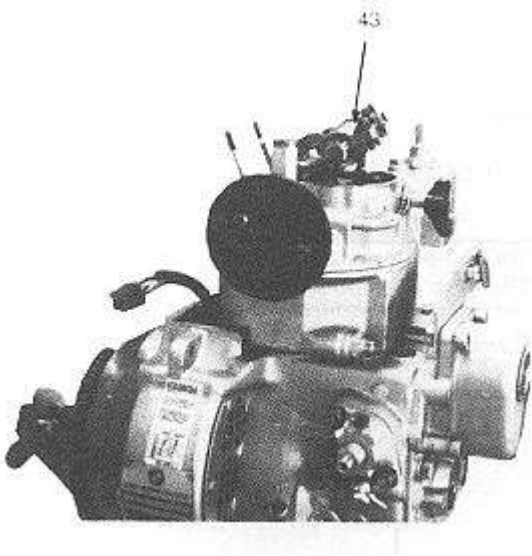

NOTE

Check that the rocker arms are free to move

- Adjust valve clearance
- Fasten cylinder head cover and vent hose clamp with both nuts
- Fasten injection pipe to the injection pump and to the injector
- Attach leak-off-line hose to the injector
- Install water pump
- Fasten water hose to the water pump and to the exhaust manifold
- Attach air filter
-

Assemble Valves, push rods, rocker arms, cylinder head cover.
Install Injection pipe, leak-off-line, water hose, air filter

Adjust valve clearance and timing

The following must be carried out:

NOTE

Carry out the testing and adjusting when the engine is cold.

- Set the decompression lever to "0"
- Remove cylinder head cover
- Crank the engine in rotation direction until the compression resistance can be felt
- Check valve clearance between rocker arm and valve shaft with a feeler gauge

- In the case of incorrect valve clearance, loosen the lock nut and adjust the set screw with a screwdriver so that the feeler gauge can be pulled through between the rocker arm and the valve shaft with noticeable resistance after the nut is re-tightened

Repair Data Valves				
Cylinder Head	Dimension	D7 nominal values	Max. allowable wear (mm)	Remarks
Valve clearance cold	mm	0.15		
Intake valve stem dia	mm	7	0.05	
Exhaust valve stem dia	mm	7	0.05	
Intake valve disc dia	mm	30.5		
Exhaust valve disc dia	mm	30.5		
Valve sit back max	mm	0.70		CAUTION! Valve sit back may not be less than 0.45 mm as otherwise the danger exists that the valve disc hits the piston.
Valve sit back min	mm	0.45		
Valve guide bore				
Outer diameter	mm	7	0.05	The sealing surface of the cylinder head can be reworked to a maximum of 0.5 mm if the sit back of 0.7 mm is exceeded due to valve seat milling.
Valve guide bore in cylinder head	mm	10		
Valve guide press in force	mm	10		
	kp	100		With the cylinder head cold.

Adjust Valve clearance

Decompression lever adjustment

If the engine is not decompressed in Position “1” of the decompression lever, adjust the decompression screw as follows:

- Crank the engine to the same position as in the valve adjustment
- Turn the decompression lever to Position “1”
- After loosening the hex nut, turn the adjusting screw to the right until the rocker arm touches the valve shaft
- From this position, turn the adjusting nut another quarter ($\frac{1}{4}$) revolution to the right and secure by tightening the nut.

The engine is equipped with automatic decompression.

Function:

- If the handle is set to Position “2”, cranking the motor automatically turns the handle further to Position “0” (compression)
- A specially designed tappet turns the decompression shaft further with every raising of its valve.

Extract the clamping sleeve of the gear segment on the valve shaft with pointed pliers and dismantle the decompression shaft with gear segment.

Installing the automatic decompression system

NOTE

The hole for the clamping sleeve in the gear segment, viewed from the flattened side of the shaft, lies towards the outside of the engine.

In this arrangement, the automatic decompression is operated by the left tappet (when looking towards the timing gear side). The decompression handle turns clockwise.

The length of the tappet (with collar) is adjustable. The standard length is 147.8 – 148 mm

Adjust Automatic decompression

Timing gear adjustment

Correction is required in the following cases:

- If the collar pan constantly engages the cog lightly, in the case of running the engine and zero position of the decompression lever (Shaft moves back and forth)

In this case, shorten the tappet somewhat and dimension "A" will become larger (see figure)

- The decompression shaft is not rotated further properly from position "2" of the handle

In this case, lengthen the tappet somewhat and dimension "A" will become smaller (see figure)

Correct the position of the collar pan to the cog (lateral distance) by a small movement of the rocker arm shaft on the cylinder head plane.

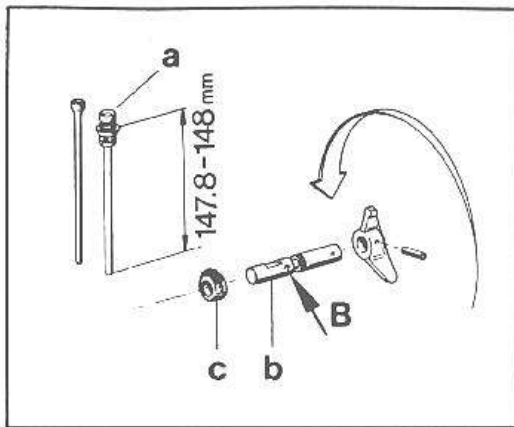

NOTE

Choose distance "B" so that certain functioning of the automatic system is ensured. In the running position of the engine (lever position "0") the collar pan may not touch the cog.

Fix the cog segment on to the shaft so that the clogged area is on the upper side when the flattened part of the shaft points upward.

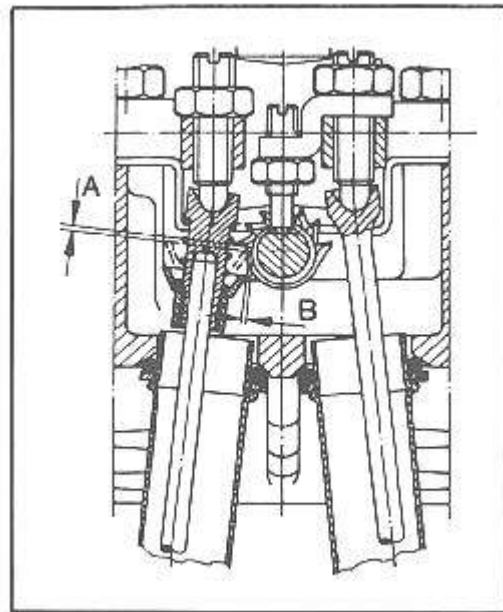

Adjust Decompression lever

Injector check

Check injection valve for:

- Function
- Injection pressure (ref figure with pintle type nozzle)

CAUTION

Be sure to observe a maximum of cleanliness when working on the fuel system

- Remove injection pipe and leak-off-line
- Loosen M6 hex nut and remove injector from the cylinder head together with holding bracket

NOTE

During removal and installation of the injector, pay attention to the sealing washer in the cylinder head

Position of the sealing disc: the side with a recess towards the injection nozzle. The sealing washer must seal properly.

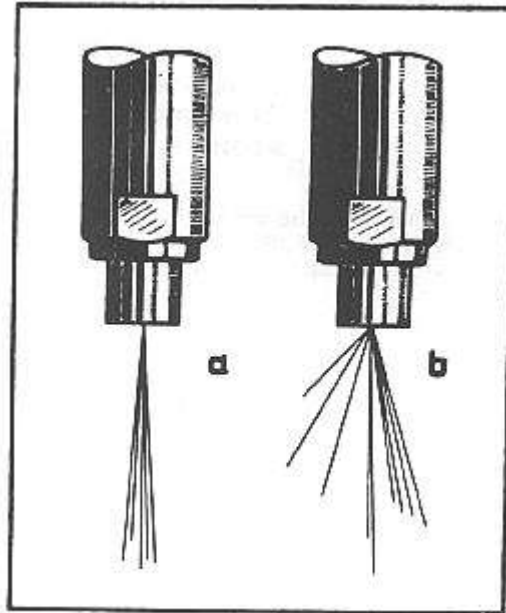

Fuel Injection Equipment		
		Remarks
Injection Pump Bosch type code Bosch No BMW Part No	PFE 1Q 55/19 0 414 050 996 1351 1329 656	With second hole in housing (for automatic venting)
Injector Assy Bosch type code Bosch No BMW Part No	- 0432 297 022 1351 1329 667	
Nozzle Bosch type code Bosch No BMW Part No	DNO SD 21 0434 250 001 1353 1329 669	
Injection pressure	135 bar	

Remove Injector

Check Injection system

- Adjust the injection pressure by inserting or removing shims at the injector spring

NOTE

A shim with a thickness of 0.1 mm changes the pressure by approx. 15 bar

- Unscrew the screw cap and remove the injector nozzle

CAUTION

- Clean the nozzle only with a Bosch nozzle cleaning device.
- Do not use hard objects as steel brushes, wire or similar.
- Carry out the cleaning and testing of the nozzle with a maximum of cleanliness, rinse injector parts in clean fuel only. Microscopically small particles can lead to wear and malfunction.

NOTE

A malfunctioning nozzle leads to, amongst other things, poor combustion (black exhaust smoke), poor performance and overheating of the cylinder head, piston and cylinder.

Injector overhaul

Extreme cleanliness is necessary during work on injector.

- Unscrew sleeve nut F (22 mm) and withdraw injector jet G
- Clean jet with correct apparatus, not with sharp tool, wire brush or similar. All traces of carbon should be removed.

Injector should be replaced as a complete unit if:

- Jet needle H is damaged or eroded
- Overheating of the needle and jet has occurred (blueing)
- Taper of jet needle does not seal

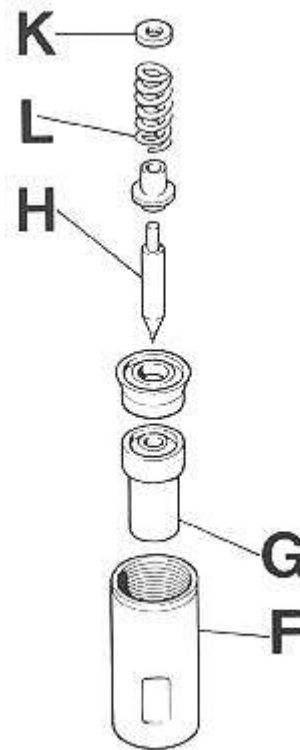

Injector operation check and adjustment

This should be carried out as completion of checking operation of injector pump.

- With special tool 74 64 1 333 545 fitted to injector pump. See page 32

Remove Injector nozzle

Injection pump

Preliminary tasks before removing the injection pump:

The injection pump has two hose connectors and a pipe connection. The lower connection is for the fuel supply, the upper connection is designed for the fuel return hose.

- Remove the injection pipe
- Clamp off the fuel supply line
- Pull off fuel return hose and fuel supply line from the injection pump

Set the engine throttle to the full position without pulling the start filling lever when removing the injection pump.

- Remove the injection pump hex nuts and pull out the pump

NOTE

Pay attention to the shims between the pump and crankcase and the washer in the pump tappet.

- First install the fuel supply line, then fasten the valve.

When installing the injection pump, rotate the camshaft so that the injection pump tappet lies on the camshaft basic radius (lowest position).

- Set regulator lever with the aid of the throttle

The start maximum fuel eccentric must be turned in such a manner that the eccentric arm points vertically upward before installing the injection pump.

- Bring the regulator lever into the center position by slightly adjusting the position of the eccentric shaft.
- Rotate the plunger on the injection pump

NOTE

The bolt must be exactly in the middle of the groove in the pump housing.

- Insert the shims and carefully slide injection pump in without shifting the regulating bushing

Remove Injection pump

NOTE

- Slide the pump in to about the last 4 mm without overcoming any resistance. Only then may resistance occur due to the tension of the tappet spring
- This tension can be overcome by a small pressure and the pump pushed in completely by hand.

If this is not possible, the plunger pin is interfering with the regulator lever.

CAUTION

- A fastening of the pump in this position would cause serious damage to the pump, regulator lever and, in some cases, to the engine (during start, because of a blocked regulator)
- Determine the correct position of the injection pump:
 - (1) Move the throttle in both directions. The regulator lever must audibly reach its stops.
 - (2) Remove the injection pipe together with delivery valve holder

NOTE

- When moving the throttle and the start filling button, the pump plunger must rotate
- Screw down the injection pump after the completed check
 - Connect the fuel supply line and fuel return hose
 - Adjust injection pump

Injection Pump Adjustment	
Injection timing – delivery end in degrees before TDC	11.5 – 12.5
Delivery stroke in mm	1.40

NOTE

The injection pump of this engine has the helical groove on top of the plunger. The adjustment of the injection timing and delivery stroke is therefore done at the injection end.

Preliminary work:

- Clamp off the fuel supply line
- Unscrew injection pump pressure valve holder. Remove spring, sealing ring, valve cone and pressure valve (see figure)
- Screw in adjusting device No 74 64 1 333 535 with sealing ring and pressure valve body

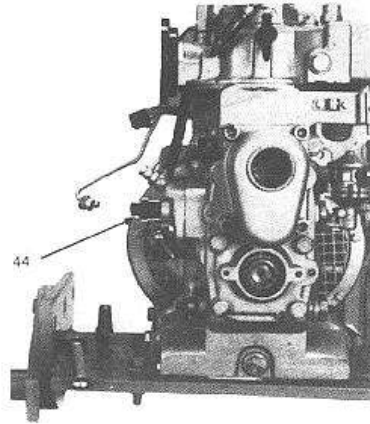

Set throttle into position "START". Do not pull cold start filler.

- Set flywheel to approx 2.00 mm before top dead center (observe direction of rotation)
- The marking for top dead center (OT) as well as the degrees for the injection pump timing are located on the flywheel
- The countermarking on the crankcase is located on the flange thread hole on the upper right (when looking at the flywheel)
- Insert dial indicator with extension pin with the zero setting at 1.00 mm and clamp (45)
- Open the fuel supply line. Fuel free from air must flow from the adjustment device.

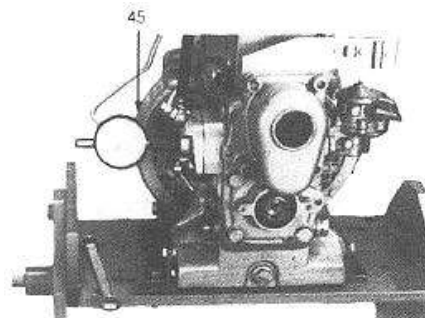

Adjustment of the delivery end:

- Crank the engine in the direction of rotation until the fuel stops to flow from the adjustment device
- Slowly crank further, until the fuel just begins to flow again

NOTE

The number of degrees indicated on the flywheel must correspond with the nominal values (11.5 – 12.5° BTDC). If the values do not correspond, correct with the shims inserted under the pump.

Basic rule:

More shims = delivery ends later (lower number of degrees)

Less shims = delivery ends earlier (higher number of degrees)

In order to determine which thickness of shims must be removed or added, rotate the flywheel to the required number of degrees from the delivery end already determined (dial indicator set at zero)

The value shown on the dial indicator corresponds to the thickness of the shims which must be added or removed in order to compensate for the difference.

NOTE

Repeat the procedure after the adjustment as a double-check

- Set the delivery stroke at the correctly set delivery stop.
Set the dial to zero.
- Rotate the flywheel against the direction of rotation until the dial indicator indicates the delivery stroke value.
Hold the flywheel at this position.

At this point fuel must just start flowing out of the leak-off-line. If this does not occur, loosen the start filling lock nut with wrench No 74 64 1 333 517 and carefully turn the eccentric shaft with wrench No 74 64 1 333 528 until the fuel begins to flow.

- Subsequently tighten the locknut again

NOTE

As a check, also repeat this adjustment.

- After the adjustment is completed remove the dial indicator and install the completely assembled delivery valve with injection pipe in the correct sequence.

NOTE

Pressure valve body with the exterior truned groove lies in the direction of the pump tappet.

When screwing in the injection pipe, replace the internal copper sealing ring and the external O-ring. Observe tightening torque.

CAUTION

When adjusting rpm it is imperative that a tachometer is used

NOTE

The camshaft is geared down in a ratio of 1:2. The rpm measured there must therefore be multiplied by 2 in order to arrive at the nominal rpm

- In order to adjust the rpm, remove the plastic plug and loosen the retaining nut
- Turn the eccentric shaft, recognisable from the outside only as a set screw, with the aid of a screwdriver, until the desired rpm is reached
- Move the throttle in the direction of STOP briefly after each adjustment of the eccentric shaft and then bring the throttle to the full throttle stop position
- Check injection pump and injection valve for correct function (46)
- After having correctly adjusted the rpm, fasten the retaining nut again and insert the plastic plug

Preliminary work for the functional check of the injection pump and injection valve

- Remove injection pipe
- Vent the engine correctly

NOTE

Carry out the check with the throttle in the fully open position and with the starting filling not pulled.

- After installing the testing device No 74 64 1 333 545 of which the connections at the sides must be closed off, crank the engine by hand until the pressure gauge shows a pressure of 300-350 bar

WARNING**Danger of Injury**

- Stop cranking and watch whether the pressure is maintained. If the pointer falls back, and if the pump does not maintain a pressure of 250 bar either, the injection pump is defective

NOTE

During the testing, the injection valve can be connected to the testing device in place of a blind plug.

WARNING**Danger of Injury**

- When cranking the engine by hand, watch the injection pressure on the pressure gauge and the function of the injector

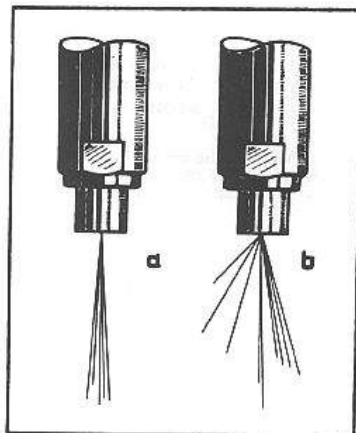

Correct function "a"

Incorrect function "b"

WARNING**Danger of injury due to the fuel jet**

As the engine has automatic fuel system venting, the necessity for a manual venting does not apply, as the trapped air in the injection pump escapes through the return line during the filling of the pump with fuel.

Due to the pulsating of the feed pump, the restrictor causes a constant flow of fuel in the injection pump. Possible gas bubbles are automatically drawn off, thereby service interruptions resp. interferences are prevented.

NOTE

In the case of possible service interferences and after longer periods of engine standstill check the functioning of the vent valve.

- Crank the engine with the handcrank resp. starter and remove the vent valve at entry to the fuel tank
- Fuel must pulse from the fuel line

If this is not the case, stop the engine and unscrew the vent valve

- Clean the valve with fuel and compressed air, resp. replace the valve
- When cleaning the fuel supply pump, unscrew cover and remove filter.
- Clean the fuel filter, especially under protruding corners of the cover
- Insert the filter again, fasten cover.

Check Injection pump, injector

Check Fuel jet, venting
Clean Fuel pump

Cleaning the air filter

- Loosen clips. Remove filter element.
- Remove sealing ring from cover and clean groove
- Install new sealing ring and filter element.

NOTE

Never use an old filter element

- Clean air intake openings and pipe in the filter

NOTE

Premature engine wear occurs if unfiltered or badly filtered air is drawn in through a badly maintained air filter

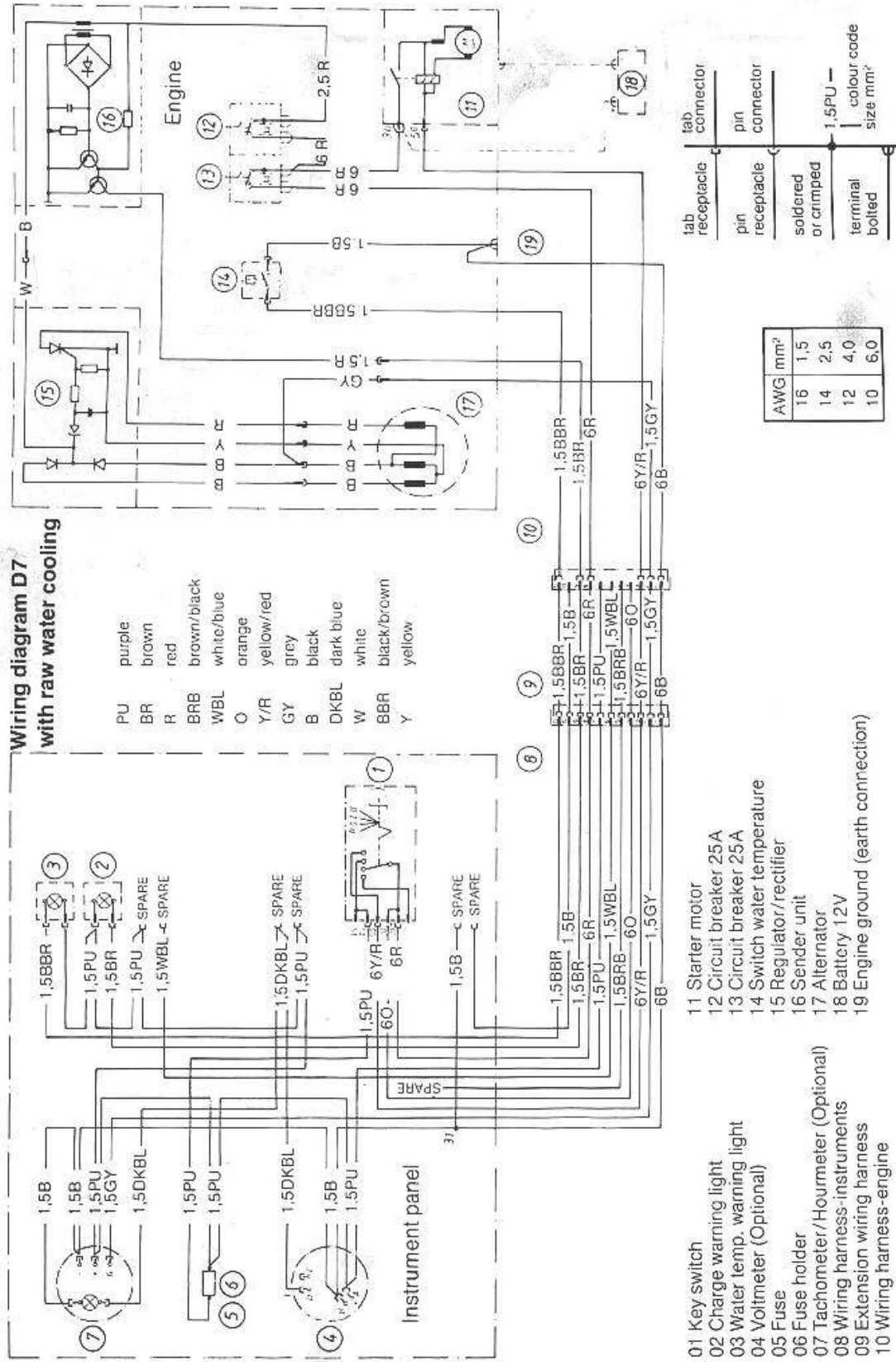

Preparation

- Remove starter motor
- Detach gearbox/clutch cover assembly
- Remove clutch
- Remove flywheel

Rotor Removal

- Extract spring clip A from flywheel magnet by inserting snip-nosed pliers into cut-outs provided

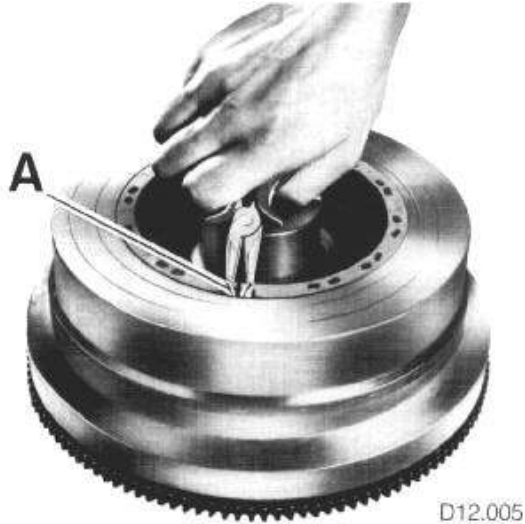

- Pull magnet B from flywheel with even movement, if necessary with suitable puller



Generating Equipment Removal

- Disconnect leads from temperature sensor and remove stator cable plug C from socket on equipment carrier
- Remove bolts D (13 & 19 mm), noting position of spacers, washers and injector pipe clip (if fitted) and remove carrier and equipment complete from engine.

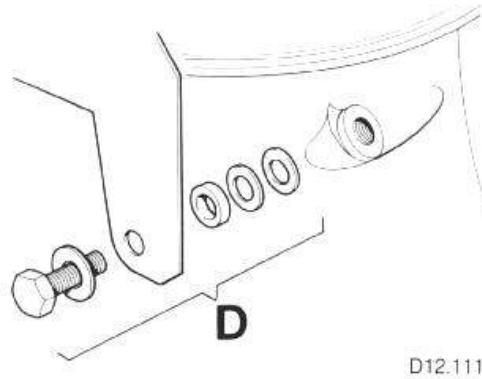
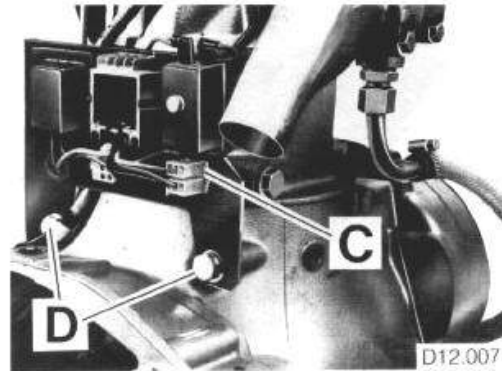

Stator Removal

- Detach plug E from stator cables with fine implement, first marking their positions.

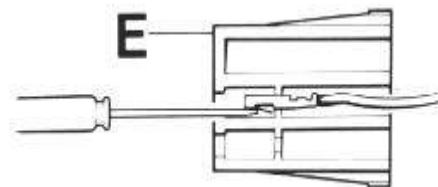

- Flatten lockwasher/cable clip F (renew on assembly), securing stator cable to bearing housing (SW 13)
- Remove bolts G (7 mm) and lift off stator

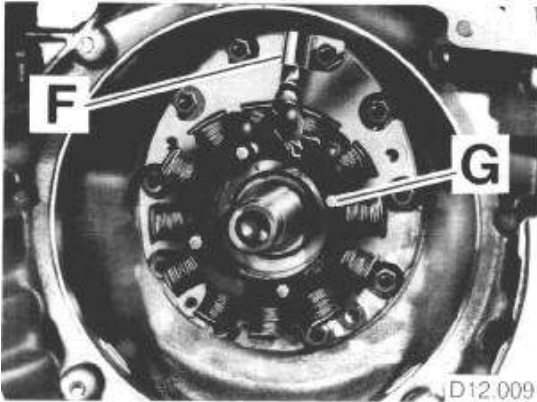

- Lay stator harness close to bearing housing, to avoid contact with flywheel
- Bend tags of stator cable end slightly to ensure firm fit before fitting to plug. Note fitted positions of cables.

Operation check and fault-finding

- Check that cable insulation is in order
- Examine stator windings for possible damage
- Check all connections for corrosion and ensure that connections are firm
- The generator generates current without mechanical contacts and has no bearings. Faults, therefore, generally arise from short-circuits, loose or wrong connections in electrical circuit of boat.

When faults occur, first check circuit, then operation of generator in situ (see wiring diagram)

Required for testing are:

- Voltmeters 0-15 DC, 0-250 AC
- Ammeter 0-40
- Test/amp 12V

Notes on Assembly

- Grip magnet (rotor) firmly by hand and carefully place in flywheel, taking care to avoid jamming by lowering unevenly. If necessary, tap magnet with judicious use of soft-faced hammer

CAUTION

Do not hit magnet directly with a metal tool, or heat flywheel (loss of magnetism can result)

Fault	Possible Cause	Check	Remedy
Control lamp remains lit after starting engine	Faulty impulse transmitter. Faults in boat circuit (e.g. short circuits)	Check impulse transmitter (see section checking procedure 1)	Check boat circuit for faults. Renew impulse transmitter
	No charge	Check charge (see checking procedure 2)	See 2 (this table)
No charge	Defective control unit	Check voltage (see checking procedure 3)	Depending on result renew control unit and/or generator
	Faulty generator (control unit is usually also defective)	Check voltage (see checking procedure 3)	Renew generator rotor and/or stator. Possibly renew control unit.

Checking Procedure 1 – Impulse Transmitter

Thin red lead of impulse transmitter earths control lamp when engine is stationary. When charge from control unit passes through transmitter, this earth is interrupted.

To check:

- Disconnect thin red lead from boat circuit and connect 12V testlamp connected to B+ (charge lead)
- With the engine stationary, testlamp should light, and at 1150 rpm extinguish
- If the lamp does not extinguish, impulse transmitter is defective and should be renewed, or generator is not charging.

- When no or insufficient charge are shown, control unit and/or generator are defective
- For further fault location, voltage between each of the 2 black leads, red lead and generator should be checked.

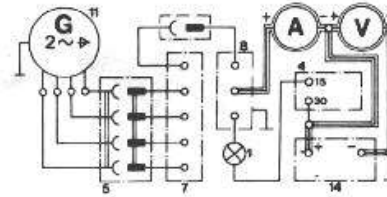

D12.011

- 4 Starter solenoid
- 5 Connector
- 7 Regulator
- 11 Generator
- 14 Battery

Checking Procedure 2 – Charge Current

Charge current passes from control unit (white lead) through impluse transmitter (black lead – thick red lead) to B+ (connection 30)

To check:

- With engine stationary, disconnect thick red cable from boat circuit and interpose 0-40 Amp ammeter
- Start engine, switch one or two items of electrical equipment on (to load battery)

Checking Procedure 3 – Voltage Check

(without load)

This check enables generator to be checked independently of control unit and battery

- With the engine stationary, disconnect control unit from generator (2 black, red lead from 4 pole plug)
- Connect one black lead and red lead to 250V voltmeter, ensuring remaining black lead cannot earth
- Start engine, set to maximum speed and compare reading with that specified (see diagram)
- Repeat test with second lead
- If reading is correct, generator is in order and charging fault lies with control unit or boat circuit.

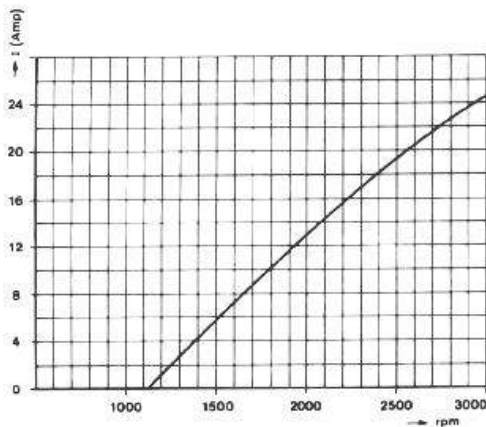

D12.113

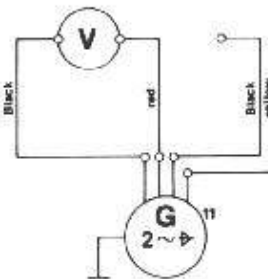

D12.116

- If reading is not adequate, whereby reading of leads 1 and 2 are different, there are 2 possibilities:
 - when both leads lie below the correct reading, rotor magnetism is inadequate and rotor should be replaced
 - when only one lead shows a low reading, a fault in the stator windings is indicated and the stator should be renewed.

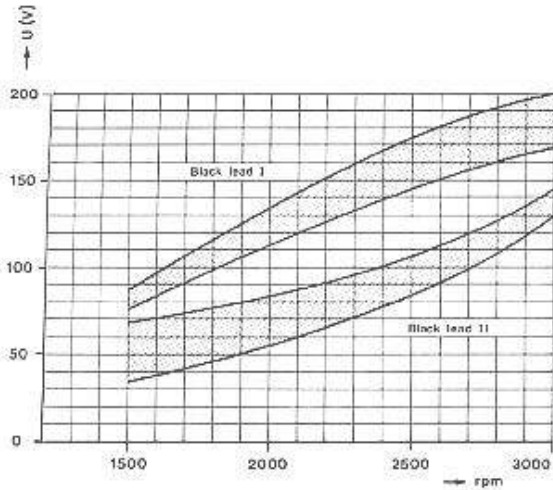

D12.114

Starter Motor Removal

- Disconnect cables A from solenoid (connector 19mm) and remove insulation B
- Remove fixing nuts C (19mm) and detach earth strap D from upper stud
- Lift off starter motor

When faulty renew.

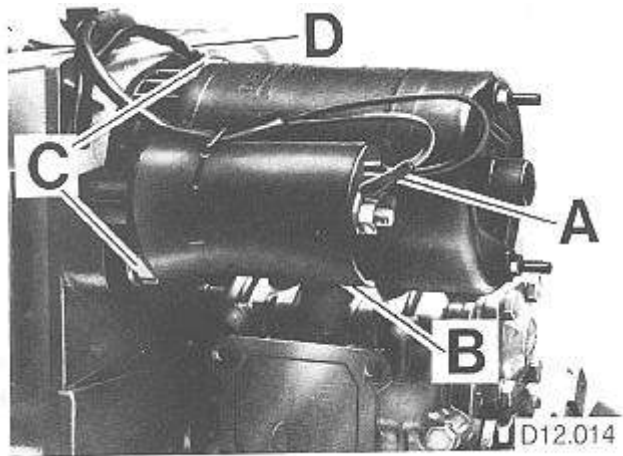

Service Instructions

A. Disassembly

- Remove cover screws, cover and gasket
- Press out impeller with 2 screwdrivers
- After removing the cam, remove residual traces of sealing compound from cam and pump housing
- Remove lip seal and O-ring
- Remove bearing assembly circlip
- Remove the shaft with ball bearing by pressing in the impeller side of the shaft
- Press off the ball bearings from the shaft. Do not press the ball bearings over the sealing surface of the shaft

B. Assembly

- Press the ball bearings on to the shaft. Do NOT press the ball bearings over the sealing surface of the shaft
- Press the shaft with ball bearings into the pump housing and fit the circlip and sealing plates (11)
- Assemble O-ring and sealing plate with the opening towards the impeller
- Fasten the cam, before doing so, apply sealing compound to cam and screw to prevent leakage
- Lubricate the impeller and fit it with a rotating movement in the intended direction of impeller rotation
- Fit a new gasket before mounting the cover

Weight and Dimensions

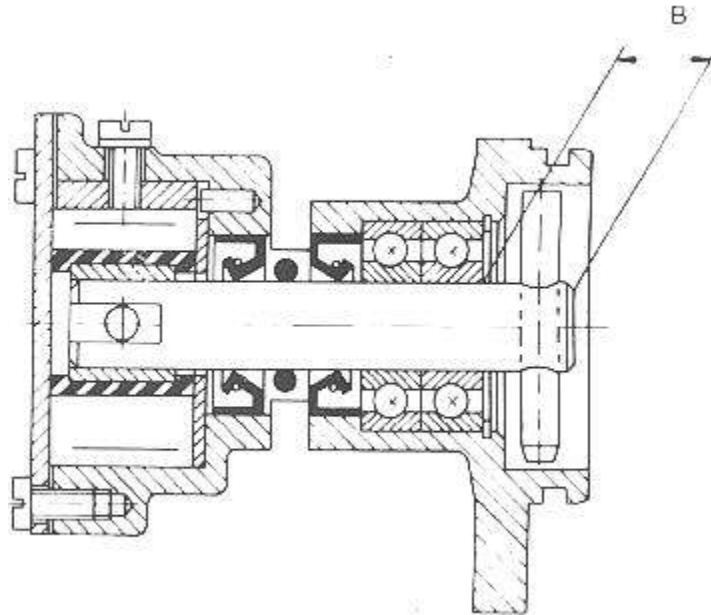

Type: F35B-8
 Dimension B 12.5
 Weight 0.5kg

Performance Table F35B-8 Impeller Neoprene												
Kp/cm ²	500 rpm		700 rpm		900 rpm		1400 rpm		2000 rpm		2500 rpm	
	kW	l/min	kW	l/min	kW	l/min	kW	l/min	kW	l/min	kW	l/min
0.3	0.06	3.6	0.06	5.2	0.09	6.8	0.13	11.2	0.18	16.0	0.18	20.5
0.6	0.06	3.4	0.09	4.6	0.09	6.2	0.13	10.6	0.18	15.8	0.18	19.6
1.0	0.06	2.7	0.09	4.0	0.09	5.6	0.13	9.2	0.18	13.6	0.18	17.0

Performance stated is for new pumps and water at room temperature

Waterpump

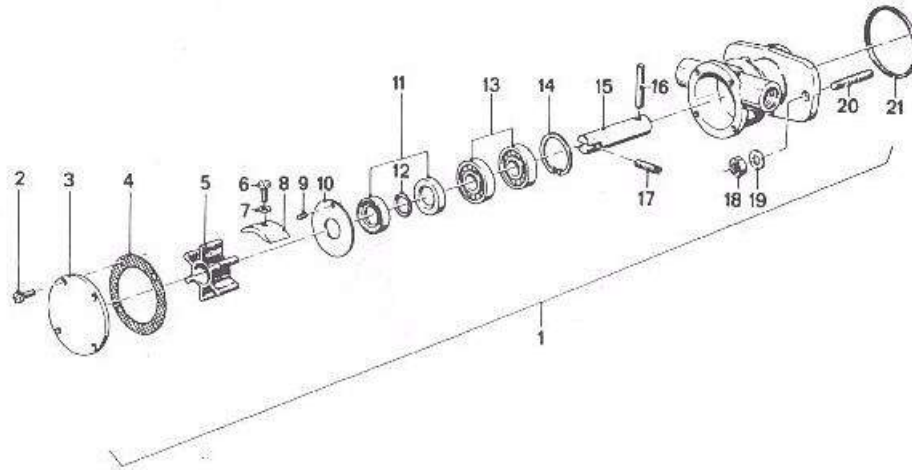

- | | |
|-----------------------------|------------------------------|
| 1. Sea water pump | 12. O-ring |
| 2. Cheese head screw M4 x 8 | 13. Deep groove ball bearing |
| 3. Cover | 14. Snap ring |
| 4. Seal | 15. Shaft |
| 5. Impeller | 16. Clamping sleeve |
| 6. Cheese head screw | 17. Stop screw |
| 7. Washer | 18. Hex head nut M6 |
| 8. Cam | 19. Washer |
| 9. Straight pin | 20. Stop screw M6 x 16 |
| 10. Sealing plate | 21. O-ring |
| 11. Sealing ring | |