

BERTRAM YACHT

450

OPERATOR'S MANUAL





DETACH BEFORE MAILING



BERTRAM

3003 N.W. 29 STREET, MIAMI, FLORIDA 33142 / TELEPHONE (305) 633-5011

WARRANTY CARD

Name _____
Last _____ First _____ Middle _____
Street _____
City & State _____ Zip _____
Telephone _____ Hull No. _____
Date of Purchase _____ Dealer _____

I have received a copy of and have read The Bertram Yacht Warranty and understand that said Warranty becomes effective upon receipt by Bertram Yacht, Inc. of this Warranty Card, completed and signed. I understand that there is no other Warranty by Bertram Yacht, Inc. applicable to the above described boat purchased by me.

- I have received my Owners Manual.
- I have not received my Owners Manual.

BOAT NAME: _____

THIS WARRANTY DOES NOT APPLY TO
COMMERCIAL/CHARTER BOATS

PURCHASER'S SIGNATURE



BERTRAM YACHT, INC.

LIMITED WARRANTY (U.S.A.)

The limited warranty: Bertram Yacht, Inc. ("Bertram") warrants, subject to the limitations herein, to the first retail purchaser of this yacht ("first owner") *provided* the First Owner completes, signs and returns the Bertram Warranty Registration Card to Bertram at the address below by certified mail, return receipt requested, within (10) day of the First Owner's purchase of the yacht, and any properly registered subsequent owners, that it will repair or replace defects in (a) items manufactured by Bertram for one (1) year and (b) the yacht's hull and its fiberglass structural components for five (5) years. These warranties run from the date of Delivery. "Delivery" means the date of the actual delivery of the yacht to the First Owner. Unless prohibited by applicable state law, an action hereunder shall be barred unless it is commenced with in (1) year from the date the cause of action accrues, regardless of the time remaining in the applicable period above.

Bertram's Obligation. Bertram's obligation is limited to repairing or replacing, at its option, any covered items found to be defective at a facility designated by Bertram. Repaired or replaced items shall be warranted as provided herein for the remainder of the applicable warranty period. Defective parts or components that are replaced shall thereupon become the property of Bertram.

Procedures. Notice of defects occurring under this Limited Warranty *must* be given to Bertram within a reasonable time, not to exceed thirty (30) days after discovery, or the time such defect should reasonably have been discovered, in writing, at the address below, by certified mail, return receipt requested. All notices must include the owner's name, address, phone number, the hull number, the nature of the defect, the date it was discovered, the date of purchase, and the name and address of the party from whom the yacht was purchased. A copy must also be sent to the dealer from whom the yacht was purchased. The owner must thereafter provide all information necessary to allow Bertram to verify compliance with these requirements. The dealer must obtain Bertram's written approval before repairing the yacht and must follow all applicable Bertram procedures. As to items not covered by this Limited Warranty, the owner may contact the appropriated manufacturer representative, to which the dealer will direct the owner on request.

Future Improvements. Bertram reserves the right to improve its design or materials without any obligation to incorporate any changes into any previously manufactured yachts.

Exclusions: This Limited Warranty is **NOT** applicable to:

- a. Damage to a yacht part or component, caused by any alteration, modification, or repair, or which has been removed from the yacht, unless specifically authorized in writing by Bertram.
- b. Paints; varnishes; gelcoats; anti-fouling products; chrome plated, anodized, aluminum, or other plated finishes; the color fastness of materials or finishes; external wood paneling, siding, and trimming; stainless steel, fabrics and canvas – all of which are subject to the effects of different climates and use (including cracking and crazing); osmosis blistering if the original gelcoat surface has been altered in any way – including repair, application of any coating other than marine antifouling bottom paint, improper surface preparation for paint, or excessive sanding of sandblasting.
- c. Engines, engine parts, controls, accessories, air conditioning systems, transmissions, electronics (including the installation thereof unless installed by Bertram), batteries, appliances, propellers, generators, and any equipment not manufactured by Bertram. Some of these items are warranted by their manufacturers as stated in the applicable warranties as supplied by their manufacturers. The owner shall look exclusively to these manufacturers for any and all such warranty claims.



- d. Yachts which have been used for or subjected to: commercial or charter service; careless operation, grounding, collision, hurricane conditions or other extreme forces of nature; military or paramilitary operations; racing, towing, improper storage, service or maintenance; negligent operation; lack of maintenance; improper use; use in violation of instructions provided by Bertram; or use in violation of Federal, State, or other governmental laws, regulations, or rules.
- e. Any published or announced catalog speeds; fuel consumption; weight; draft and performance characteristics; since these are estimated or obtained from test runs.
- f. Electrolysis, galvanic or crevice corrosion, or any deterioration of underwater items or items requiring repairs or replacement as a result of lack of maintenance or improper use.
- g. Any damage or failure that occurs from either increasing the horsepower of the original engines installed by Bertram.
- h. Compliance with the laws, regulations, or rules of any governmental or regulatory body or agency other than the U.S.A.
- i. Direct, incidental, or consequential damages, costs or expenses, including but not limited to, loss of time, inconvenience, rental charges, travel expenses, loss of use, dockage fees, towing and storage charges, and the costs of transportation to the repair facility designated by Bertram, incurred as a result of any defects, or as a result of any steps the owner must take to become entitled to repair or replacement, and injury or damage to persons or property resulting from information provided by the dealer if erroneous or not approved in advance and in writing by Bertram. **SOME STATES DO NOT ALLOW THE EXCLUSION OF LIMITATION OF INCIDENTAL OR CONSEQUENTIAL DAMAGES SO SUCH LIMITATION MAY NOT APPLY TO YOU.**

DISCLAIMER; LIMITATION OF DURATION OF IMPLIED WARRANTIES. EXCEPT FOR THE REPAIR OR REPLACEMENT BY BERTRAM OF ITEMS COVERED BY THE LIMITED WARRANTY, BERTRAM MAKES NO OTHER WARRANTIES EXCEPT FOR THE IMPLIED WARRANTIES THAT CANNOT BE DISCLAIMED, ALL OF WHICH ARE LIMITED IN DURATION TO THE APPLICABLE PERIOD PROVIDED IN THE LIMITED WARRANTY. SOME STATES DO NOT ALLOW TIME LIMITATIONS ON HOW LONG AN IMPLIED WARRANTY LASTS, SO THIS LIMITATION MAY NOT APPLY TO YOU.

Modifications; Subsequent Owners. This limited warranty may only be modified in writing by an authorized Bertram officer. No dealer or other party may modify the Limited Warranty. Subsequent owners to the First Owner may register to qualify for the benefits of this Limited Warranty by following the procedures specified after contacting Bertram at the address and phone set forth below.

Venue. To the extent permitted by law, venue for any dispute shall lie in Miami-Dade County, Florida, unless an alternative venue is elected by Bertram.

THIS WARRANTY GIVES YOU SPECIFIC LEGAL RIGHTS AND YOU MAY ALSO HAVE OTHER RIGHTS WHICH VARY FROM STATE TO STATE.

Bertram Yacht, Inc.
3663 NW 21st Street
Miami, Florida 33142
Telephone; (305) 633-8011
Telefax: (305) 633-2868

FOREWORD

Do not attempt to operate your vessel until you are thoroughly familiar with the contents of this manual and all of your vessel's onboard systems.

Included in this manual are the appropriate warnings, cautions, notes, and maintenance information for your Bertram's onboard systems. Additional information pertaining to the equipment installed on your boat is provided by the manufacturers of the equipment and is located in the owner's information case, which was placed aboard before delivery. It is very important that you study these manuals and understand the operation of all of the systems.

Your Bertram's unique design and the care taken in its manufacture will give you outstanding performance and many years of boating pleasure. Your Bertram is built with the finest materials available and handcrafted to Bertram's demanding quality control standards. It is factory tested and thoroughly inspected.

As durable as it is, your Bertram will benefit from reasonable care. A yacht is a complex mechanism. It will require preventative and corrective maintenance and minor adjustments. This operator's manual helps explain the operation and required maintenance of the many systems onboard your boat.

The better you understand your Bertram, the more pleasure you will get from it. We recommend that you read this manual and all manuals thoroughly, and keep it onboard for reference. If any points in this manual are unclear, your Bertram dealer will be happy to assist you.

This manual is not intended to replace years of boating experience or the excellent classes on boating safety offered by the United States Coast Guard Auxillary and the United States Power Squadron. We have included material that covers some of the aspects of safe boating, but we urge you to attend a safe boating course and stay current on navigation and safe boating practices.

YOUR VESSEL'S DOCUMENTATION

This manual contains the following:

- ✓ ✓ Glossaries of nautical, wave, and weather terms
- ✓ ✓ Technical specifications
- ✓ ✓ Equipment descriptions
- ✓ ✓ Service information
- ✓ ✓ Supplementary illustrations including the docking plan, electrical drawings, and mechanical drawings
- ✓ Bertram warranty registration card
- ✓ Package containing the user manuals and operation instructions supplied by the manufacturer of each major mechanical and electrical system component

Please complete all of the warranty registration cards and return them to the respective manufacturers. This will help you receive service rapidly and efficiently. It will also protect you in the event of a product safety recall.

WARNINGS, CAUTIONS, & NOTES

Throughout this manual, you will find special information in the form of warnings, cautions, and notes. These are intended to alert you to possible dangers to yourself, passengers, and crew. Please read these special information items carefully. Pay close attention to the warnings and exercise good seamanship. You are the most important factor in preventing accidents.

WARNING

FAILURE TO HEED A WARNING MAY RESULT IN SERIOUS INJURY OR DEATH.

CAUTION

Failure to heed a caution may result in injury and/or damage to your vessel.

NOTE

A note is intended to emphasize important information.

UNITED STATES COAST GUARD REGULATIONS

If your Bertram is to be operated in the waters regulated by the United States Coast Guard, there are certain requirements that must be met. These requirements are discussed in the Coast Guard Publication *Federal Requirements for Recreational Boats*.

Some, but not all, of the items you are required to carry aboard are furnished as standard equipment on your vessel.

If you are operating in the U.S. territorial waters, the Coast Guard Regulations require that all vessels of 12 meters (39.4 feet) or more in length carry aboard a copy of the USCG publication *Navigation Rules, International – Inland*.

NOTE

United States Coast Guard Regulations state that it is the responsibility of the vessel owner to be certain that all required equipment is onboard and in proper working order.

*Bertram has supplied you with a copy of **Navigation Rules, International – Inland**.*

*Regardless of how much experience you have, it is important to refresh your memory by studying the **Navigation Rules** on a regular basis.*

VESSEL INFORMATION

Vessel Name

Owner's Name

Owner's Address

Hailing Port

Hull Identification Number

Registration Number

TECHNICAL DATA

Length Overall	41 feet, 8 inches	(12.7 meters)
Length Hull	39 feet, 0 inches	(11.9 meters)
Beam	13 feet, 4 inches	(4.05 meters)
Draft (as built)	4 feet	(1.22 meters)
Fuel Capacity**	459 U.S. gallons	(1740 liters)
Water Capacity**	106 U.S. gallons	(400 liters)
Displacement*	34,398 lbs	(14,700 kg)
Height Above Waterline (bridge)	12 feet, 7 inches	(3.84 meters)

* Full fuel and water, 6 people, and 1000 lbs of gear

** The usable volume of fuel/water in the tank will vary depending upon sea conditions.

Main Engines and Transmissions

Please see the information provided by the manufacturers and the Bertram Yacht Sea Trial Report.

Propellers

Please refer to the enclosed Sea Trial Report.

Propeller Shafts

Shaft Material:	Aquamet 17
Shaft Diameter:	2.250 inches
Shaft Length:	154.63 inches
Shaft Machining:	SAE Standard J-755

NOTE

The propeller specifications are correct for the boat as delivered from the Bertram Yacht factory. Changes made to the boat's configuration (adding a tower, davit, tender, etc.) will have an impact on the vessel's performance and may alter the engine loading and require different propeller specifications. A test should be conducted to verify the correct performance.

Generator

Please see the information provided by the manufacturer.

Fuel Remaining In Tank

Fuel gauge reading vs. tank gallons

Gauge Reading	Amount of Fuel
Full	459
$\frac{3}{4}$	332
$\frac{1}{2}$	182
$\frac{1}{4}$	55
Empty	0

Ventilation & Exhaust Blowers

Head Exhaust Blowers

150 cubic feet per minute (CFM)

Engine Room

Four 250 CFM thermostatically controlled with manual override (on at 110 degrees F, off at 90 degrees F)

Pumps

Bilge pumps:

1,750 gallons per hour (GPH)

Gray water:

4.0 gallons per minute (GPM)

Black water:

4.0 gallons per minute (GPM)

MECHANICAL SYSTEMS

Propulsion System

WARNING

COMING INTO CONTACT WITH MOVING MACHINERY CAN RESULT IN INJURY OR DEATH.

CAUTION

Loud noises can damage your hearing. To prevent possible hearing loss, before you enter the engine room while the engines are running, we strongly suggest that you use hearing protection with an OSHA noise reduction of at least 20 db.

Propulsion System Care

Please thoroughly read and understand the information contained in the operator's manual for the engines installed in your vessel. All of the information that you need to operate the engines and maintain them properly is contained in these manuals. These manuals are provided to you in your operator's information briefcase.

Fuel System

Your fuel system consists of:

- A flame retardant and self-extinguishing fiberglass fuel tank with internal baffling.
- Aircraft- type fuel lines.
- Manual fuel shut-off valves at the fuel tank and in the engine room. Boats that are built to RINA (Registro Italiano Navale) standards have fuel shut-off valves outside the engine room.
- Primary and secondary fuel filters.

A fuel filter service valve facilitates servicing the filter without the possibility of fuel leaking into the bilge. Each fuel/water separator has a drain fitting at the bottom to allow the removal of collected water. The filters should be visually inspected and drained at regular intervals, depending on climatic conditions.

Fuel fill deckplates are provided on both sides of the vessel. A deckplate key is provided to facilitate the removal of the deckplate cover.

The fuel in the tank, as indicated by the fuel gauge, cannot register fuel gallonage accurately due to the shape of the tank. Keep this in mind when planning for or during a voyage, in order to reduce the risk of running low on fuel. The technical data sheet shows the approximate relationship between the fuel gauge and the actual fuel remaining in the tank.

NOTE

If diesel fuel does spill into the bilge, it is a violation of applicable laws and/or regulations to pump it overboard.

CAUTION

Never use galvanized steel fittings in any diesel fuel system. Diesel fuel reacts chemically with the zinc coating to form a powder that clogs fuel filters and may damage your engines.

Do not store fuel for long periods in your vessel's tank. Stored fuel will spoil and may damage your engines.

In some parts of the world, the diesel fuel has a greater sulfur content, which may cause poorer performance and exhaust system damage. YOU are responsible for the quality of the fuels that you use, so make absolutely sure that the diesel fuel you are using is of the proper quality. Ask your dealer to recommend an additive or filter, which will help avoid the problems associated with contaminated fuel, which can, if untreated, cause permanent damage to your engines.

Diesel fuel must be kept clean and free of contamination. Fuel contaminated with water is subject to algae growth.

Engine/Shaft Alignment

Two separate alignment procedures are performed by Bertram to ensure that your vessel's propulsion system is correctly aligned. These same procedures are necessary anytime an engine is moved or damage occurs to the driveline.

The first type of alignment is **parallel or bore alignment**. In this instance, a misalignment occurs when the centerline of the transmission and the centerline of the shaft are **parallel but not coaxial**. The allowable misalignment must be less than 0.0005 inches per coupling outside diameter. It is most unlikely that this alignment will change unless an engine is moved or serious damage occurs to the driveline. Parallel alignment procedures require precision measuring equipment and a competent technician.

The second type of alignment is **angular or face alignment**. In this instance, the shaft coupling is not parallel to the transmission output flange. The formula for allowable angular misalignment is the same as it is for parallel alignment, 0.0005 per coupling outside diameter. Therefore, for a five-inch diameter coupling, the maximum misalignment allowable would be 0.0025. Angular alignment should be periodically checked, due to engine mount sag.

The initial alignment check is considered part of the dealer's pre-delivery preparation. After delivery, the alignment is an owner-maintenance responsibility.

Propellers

The engineers at Bertram have calculated a specific combination of diameter and pitch to give your vessel the maximum efficiency and speed based on the rated horsepower of your engines. Therefore, any changes in pitch and diameter could reduce the boat's performance and engine life by placing undue stress on the engines by overloading (not achieving the rated RPM at full speed). If propeller replacement is necessary, it is vital to use the original configuration and manufacturer.

If items such as a fishing tower, tender, davit, or anything else that changes the displacement or trim of the vessel are added to your boat, it may be necessary to adjust the propeller specifications. Bertram Yacht is not responsible for any changes that may become necessary. Please contact a propeller specialist for recommendations based on the modifications that were made. Keep in mind that anything that adds weight to your boat, or affects its aerodynamics or hydrodynamics, will affect its performance.

Propeller Installation

To eliminate the possibility of propeller-induced vibration, these steps must be closely followed.

1. Inspect the shaft keyway and the key for proper fit. The key must fit snugly in the keyway.
2. Inspect the fit of the key in the propeller keyway. If the key does not fit in the keyway, carefully file the keyway (not the key) with long even strokes.
3. Place the propeller on the shaft **without the key** and seat the propeller on the shaft taper. The propeller should fit tight on the shaft without wobble and without space between the propeller hub and the shaft at the forward and aft ends of the hub.
4. Mark the location of the propeller on the aft at the forward end of the hub. **Do not use a graphite pencil.**
5. Remove the propeller.
6. Install the key in the shaft keyway.
7. Reinstall the propeller.
8. Ensure that the propeller is fully seated and the propeller hub again aligns with the mark made in step 4.
9. Using a feeler gauge, check for a 0.006 to 0.010 clearance between the top of the key and the bottom of the keyway in the propeller hub.
10. Install the full (thick) nut.
11. Tighten the nut to seat the propeller.
12. Remove the full nut, install the half nut (thin), and tighten it against the propeller hub.
Note: The half nut is installed against the propeller because there is less frictional loss when tightening the nut against the propeller. The full nut, due to the number of threads per inch, is used as a jam nut.
13. Install the full nut and tighten securely against the half nut.
14. Install the cotter pin and bend over both legs.

The sequence and method of propeller nut installation, as described above, is in accordance with S.A.E. specification # J-755.

Propeller Hazard

WARNING

TO REDUCE THE RISK OF SERIOUS INJURY OR DEATH, DO NOT ENTER THE WATER FROM YOUR VESSEL, OR BOARD YOUR VESSEL FROM THE WATER, WHILE THE ENGINES ARE RUNNING.

When swimming or working in the water near your vessel, remember that your propellers have sharp blades that can seriously injure someone who may be pushed against them by wave action or current, even if the propellers are not turning. To reduce the risk of injury from the propellers:

- Do not allow a passenger to enter the water unless the engines are shutdown.
- Do not allow anyone to board or disembark from a tender unless the engines are shutdown.

Propeller Shafts

Information regarding the diameter, length, and material of the shafts can be found in the technical data pages of this manual.

Propeller Shaft Seals

The shaft seals prevent water from leaking around the shaft and into the boat. The seals installed in your Bertram are of the dripless type and do not require adjustment as in a traditional stuffing box. Special nitrile lip seals endure a watertight fit around the shaft. A constant supply of water is necessary for cooling and lubricating the shaft and seal. This water supply is provided by hose connections from the seals to the engine heat exchanger discharge. Water must be supplied to the seals anytime the shafts are rotating. A lack of cooling water may cause distortion of the seal resulting in leakage around the shaft. A cross-over hose is installed from the starboard engine to the port shaft seal and from the port engine to the starboard shaft seal. This provides cooling and lubrication in the event that you are forced to operate on one engine. Please refer to the literature provided in your owner's information packet.

Propeller Shaft Replacement

Due to the extremely tight fit of the coupling to the shaft, it is recommended that shaft replacement be performed only by qualified technicians.

Rudder Alignment

To obtain the best handling, your rudders are adjusted to a slightly toe-in attitude. In other words, the leading edge of the rudders should be slightly closer than the trailing edge. If your steering system is disassembled for any reason, please contact the Bertram Yacht Service Department for the correct "toe-in" specification for your vessel.

Rudder Seals

The rudder seals are dripless and do not require adjustment as in a stuffing box. The function is the same as for the shaft seals. However, instead of a nitrile lip seal, there are three O-rings inside the rudder port that fit tightly between the rudderstock and the rudder port. Waterproof grease is applied during assembly and provides lubrication for the O-rings. Should the rudders need to be removed, waterproof grease must be applied during re-assembly. Care must be taken when reinstalling the rudders not to damage or dislodge the O-rings or damage the rudderstock or the rudder port.

Bilge Pump Systems

Oil Discharge Warning

CAUTION

The Federal Water Pollution Control Act prohibits the discharge of any oily waste into, or upon, the navigable water and contiguous zone of the United States. If such discharge causes a film, or sheen upon, or a discoloration of the surface of the water, or causes a sludge or emulsion beneath the surface of the water, it is considered a violation of the regulation.

This applies to any overflow of oil, as well as any bilge pump discharge.

*Violators are subject to a penalty of **\$5,000.00.***

Your Bertram has three or more independent bilge pump systems. Each bilge pump system consists of a pump, a manual/automatic control switch, and an automatic bilge pump switch.

None of the bilge pumps can be switched off from the flybridge control station. The bilge pumps are connected directly to the batteries through fuses located on the main supply panel in the engine room. The bilge pumps will continue to operate even if the battery disconnect switches are turned off. The bilge pump control is wired so that the flybridge control switches can select between automatic and manual.

An indicator light on the helm console illuminates if any one of the pumps are running. The forward, midship, and aft bilge pumps are in the lower part of the bilges, just below their bilge pump switches. This arrangement assures that there will be a positive shutdown signal to the pump when the bilges are nearly dry.

Emergency Bilge Pump

Your Bertram's main engines have the ability to pump the engine room bilges during an extreme emergency. This system should never be used or tested, except in an emergency in which there is a danger of sinking. If the electric bilge pumps can maintain the flooding, do not use the emergency system.

You may periodically want to test the emergency valves to assure that they will open in an emergency. With the **engines stopped**, release the safety latch on the valve handle, open the emergency suction valve to its full open position, and then immediately return it to its fully closed position. **Flooding will occur if the valve remains in the open position.**

Maximum pumping capacity is achieved at the maximum engine RPM. By regulating the engine speed, it may be possible to control the flooding, allowing time for temporary repairs.

WARNING

THE OPERATOR OF THE VESSEL MUST BE AWARE OF THE POTENTIAL RISK TO THE MAIN ENGINES WHEN USING THE EMERGENCY PUMPING SYSTEM.

WARNING

THERE IS EXTREME DANGER OF FIRE AND ELECTROCUTION IF WATER IS FLOODING OR SPRAYING ELECTRICAL EQUIPMENT.

IN THE EVENT OF SERIOUS FLOODING, STOP THE GENERATOR IMMEDIATELY TO LESSEN THE DANGER OF ELECTRICAL SHOCK OR FIRE.

Emergency Bilge Pump Operation

If the main engine seawater intake and emergency ball valves are not operated correctly, the main engine seawater impeller may ingest air and either stop pumping the bilge water effectively, or overheat the main engine and exhaust system. This could damage the engine and cause an exhaust hose fire. The boat could then take on additional water through the exhaust system.

A full flow of water must be present at all times. Do not allow the emergency bilge pump system to pump the bilge dry or operate with intermittent water flow.

If both the main engine seawater intake and emergency pump valves are in the open position, water will flow through the engine seawater intake and into the bilge through the emergency pumping system.

WARNING

THE BOAT WILL QUICKLY SINK, BECAUSE OF THE SIZE OF THE OPENINGS.

The engine seawater pump impeller can be damaged in only a few seconds by bilge debris or lack of water. Always maintain a constant flow of water when switching between the normal engine water intake and emergency pumping system.

Never leave the emergency system operating without constant and proper supervision.

Please read the following information carefully, and understand the serious consequences of emergency pumping system misuse.

With the bilge flooded to a level significantly higher than the emergency suction intakes and the engine at idle, open the emergency suction valve and close the main engine seawater intake. Increase the engine speed until the water level in the bilge decreases to a safe level, but not below the emergency water intake. Make temporary repairs to stop the flooding.

If the emergency bilge pump system can lower the bilge water, try to control the water level temporarily by one of the following methods:

1. Decrease the engine speed until achieving a balance between the incoming water and the amount of water being pumped overboard by the regular bilge pumps and the emergency pump.
2. Slowly open the main engine seawater intake valve until the bilge water level ceases to drop. If the engine seawater intake valve is fully opened and the water level continues to drop, slowly close the emergency suction valve until the water level ceases to drop.

CAUTION

The engine emergency suction valve must be fully opened before the engine seawater intake valve is fully closed. Never shut down the engines with both valves open.

Toilet (Head) System

CAUTION

Do not use lye-based clog dissolvers in the head system.

Do not flush the toilets when the holding tank is full, as indicated by the red indicator light on the holding tank monitor. Continued flushing could severely damage the toilet system.

NOTE

*It is unlawful to discharge untreated waste within the territorial waters of the United States. Violators are subject to fine of **\$5,000.00 per incident.***

Marine toilets on vessels operating within the territorial water of the United States shall discharge directly into a holding tank, which is to be emptied by a dockside pump-out facility, or at sea beyond the territorial limits. To satisfy U.S. regulations, all outlet seacocks on vessels operating within the Territorial waters must be locked shut with a padlock, a non-reusable wire-tie, or have the valve handle removed.

For vessels operating outside of the U.S. Territorial waters, it is generally acceptable to have a toilet system where the waste is either discharged into a holding tank and then pumped overboard, or where the toilet discharges directly overboard through a discharge seacock. However, you, as the owner, must determine and conform to local regulations whenever you operate your vessel.

To avoid damage to the head system, **do not** operate the vessel with the overboard discharge seacock in the open position.

Each toilet has a lever for flushing the toilet. Simply press the lever; the toilet functions automatically. An electronic timer will activate the toilet pump for a pre-set time.

The holding tank monitor is located in the salon D.C. panel. When the holding tank indicator light activates, the tank should be pumped according to the above regulations. The push-to test and push-to silence buttons will test to monitor the system and silence the alarm until the holding tank is emptied.

There are two ways to empty the holding tank:

1. Dockside pump-out using the waste deck plate (within Territorial waters)
2. Onboard holding tank pump (outside Territorial waters)

To accomplish onboard holding tank pump-out:

1. Switch the holding tank pump circuit breaker on.
2. Open the overboard discharge seacock.
3. Under the forward companionway sole, you will find the momentary switch for the pump. Depress the momentary switch, and hold it until you hear a change in the sound from the pump, indicating that the tank is empty.

Fresh Water System

Fresh Water Tank

The fresh water tank is located below decks. The tank is filled through a deckplate and vented overboard. The water tank level gauge sender is located inside the tank, and the gauge with a power switch is located on the D.C. distribution panel in the salon.

NOTE

The water tank can be filled only through the deckplate. It cannot be filled using the dockside water supply quick-connect fitting in the cockpit.

Fresh Water Pump

The operation of your vessel's fresh water pump is automatic and normally does not need priming, except before its initial use or if the fresh water tank is empty.

The pump holds an average static pressure of 30 psi. When the pressure drops below approximately 21 psi, the pump automatically turns on and raises the pressure. If the pressure continues to drop because of an empty tank, the low-pressure cut-out switch will shut off the pump.

To prime the pump:

- Ensure that the tank is at least partially full.
- Start the pump by lifting the momentary pump restart switch located in the salon D.C. distribution panel.
- Hold the momentary pump restart switch until the pump continues to run on its own, then release the switch.
- Once the pump has raised the pressure, open a faucet to release any trapped air.

Water Heater

The water heater is located in the machinery room, or in the forward bilge, depending on the model of your boat. The thermostat is pre-set by the manufacturer to 140-145 degrees. We recommend that you do not raise the temperature above this setting.

The water heater may be damaged if the circuit breaker is switched on when the water heater is empty. The water heater operates on 240-VAC from either the generator or shore power.

WARNING

DO NOT OPEN THE WATER HEATER THERMOSTAT ACCESS PANEL, UNLESS THE CIRCUIT BREAKER IS TURNED OFF.

Showers

The showers use a customary mixing valve for adjusting the water temperature. The hand-held showerhead is equipped with a push-button cut-off to stop the water flow without changing the temperature setting. This is to facilitate what is referred to as a yachtsmen's shower, the purpose of which is to conserve water.

Galley and Head Sinks

The galley sink drains overboard. The head sinks and showers drain into the gray water tank.

Engine and Generator Cooling Water

The engine room is equipped with a coiled fresh water hose and nozzle to facilitate filling the main engine and generator heat exchangers.

Dockside Water Supply

CAUTION

When leaving the vessel unattended, the dockside fresh water supply should be disconnected to prevent flooding the bilges in the event of a broken pipe.

The dockside fresh water quick-disconnect is located in the cockpit. A pressure regulator reduces the pressure to within limits of the onboard system.

Gray Water Tank

The gray water tank is located in the bilge below the sole. This tank has a pump and automatic float switch. The pump automatically discharges the shower and sink water overboard and receives its power through the gray water pump circuit breaker.

The gray water tank and pump must be inspected and cleaned regularly. Do not use caustic cleaners to clean the tank.

NOTE

The gray water tank circuit breaker must be in the on position anytime the air conditioner is being used, since the forward air conditioning condensate drains into the gray water tank and will cause the pump to run, even if the showers are not in use.

Gray Water Tank Monitor

The gray water tank liquid level is monitored and has an indicator light and alarm horn. When the liquid level of the gray water tank reaches a nearly full condition, an indicator light will come on and an alarm will sound. A momentary push button switch is provided to manually override the automatic operating function. If pressing and holding the switch for a few minutes does not cause the alarm horn to stop sounding and the light to extinguish, briefly press the silence button. The light will remain lit until the problem is fixed, but the alarm horn will stop sounding. Correct the problem as soon as possible to prevent the tank from overflowing.

The monitor system can be disabled permanently by turning off the circuit breaker. This monitor also includes the tank level warning system. Turning off the circuit breaker will disable the holding tank warning system as well as the gray water tank system.

Seawater & Washdown System

CAUTION

The seawater faucets are clearly labeled to prevent the accidental use of seawater for drinking or cooking. Do not use this system for fighting electrical fires, because of the potential for shock hazard.

NOTE

The seawater system should always be switched off when the boat is left unattended.

The seawater system is a convenience feature and is designed to accommodate an angler's needs. The seawater washdown system will make the cleaning of fish, fish boxes, and the cockpit area while at sea easier. The system is also an integral part of the live well system.

Live Bait Well System

The live well will keep bait alive only when it is operating and aerating the water. When the water in the live well reaches the drain near the top of the tank, the excess water will drain overboard.

To operate the live well:

- ✓ Turn on the seawater washdown pump.
- ✓ Open the water supply valve located near the overhead in the machinery room.
- ✓ Close the live well drain valve located near the supply valve.

To drain the live well after use:

- ✓ Turn off the washdown pump or close the water supply valve.
- ✓ Open the drain valve.

Windlass

WARNING

EXERCISE EXTREME CARE WHEN OPERATING THE WINDLASS, ESPECIALLY ONE EQUIPPED WITH A WILDCAT. THIS DEVICE HAS THE CAPABILITY OF INFLECTING SEVERE INJURY.

YOUR BOAT IS EQUIPPED WITH A ROCKER TYPE WINDLASS CONTROL SWITCH AT THE HELM AND TWO FOOT SWITCHES ON THE FOREDECK. IF YOU HAVE AN ASSISTANT ON THE FOREDECK, ONLY THAT PERSON SHOULD OPERATE THE WINDLASS.

The windlass is intended only to lift the anchor. It is not designed to be a mooring bit or to haul the boat towards the anchor. The correct procedure to retrieve an anchor is to slowly power forward on the main engines as the windlass is retrieving the anchor rode. After the anchor rode is perpendicular to the vessel, the windlass can then retract the anchor.

CAUTION

To avoid accidental operation, the windlass circuit breaker must always be off, except when the windlass is in use.

NOTE

If your windlass has a wildcat, the fit of chain links to the wildcat is critical. The chain must not jam, skip, or jump.

Windlass Operation

The capstan head is keyed directly to the windlass motor and will revolve whenever the windlass motor is activated.

Deploying the anchor:

- Switch the windlass circuit breaker on.
- Release the chain stopper.
- Allow the anchor to drop by carefully releasing the tension on the capstan and rotating it counter clockwise.
- You may also lower the anchor by depressing the "down" foot switch or depressing the bottom of the rocker switch at the helm station.

Retrieving the anchor:

- Tighten the tension on the capstan by turning it clockwise.
- Depress the "up" foot switch.
- You may also depress the top of the rocker switch at the helm station.
- When the anchor is fully retracted in the sheave box, reset the chain stopper and secure it with the locking pin.
- Switch off the windlass circuit breaker.

Cablemaster Shore Cord Retractor

WARNING

DO NOT PLACE YOUR HANDS INTO THE HAWSE PIPE WHEN RETRIEVING THE CABLE.

CAUTION

To prevent the cable from becoming tangled in moving machinery, always check to be certain that all of the cable is contained in the drum when completely retrieved.

The Glendinning Cablemaster is a shore power cable retrieval system designed to eliminate the necessity of manually moving the shore cord around the cockpit and dock.

The retrieval system is motorized by the D.C. electrical system and is protected by a circuit breaker on the salon distribution panel. The operating switch is located in the pilaster lockers.

The Cablemaster consists of two major components: the hawse pipe and the power unit. Within the hawse pipe, a neoprene gasket/wiper prevents the entrance of water and helps clean the cable as it is retracted into the boat. When the cable is retracted completely into the boat, the shore cord plug cover activates the "in-limit" switch, turning off the motor. The "out-limit" switch is located in the guide and roller assembly. The nylon safety collar activates the "out-limit" switch and serves as a mechanical stopping device should the "out-limit" switch fail.

NOTE

Experience has shown that when only a short section of the shore power cable is regularly used, the cable may be subjected to sharper than normal coiling, which in turn causes undue kinking of the cable. To relieve this condition, routinely pay the cable out completely and stretch it on the dock. Allow the Cablemaster to retract the cable into the boat.

ELECTRICAL SYSTEMS

D.C. Electrical System

The 24-volt direct current (D.C.) electrical system on your Bertram is powered by two banks of wet cell marine batteries. Each battery bank is used to start the main engines and supply D.C. power to onboard electrical equipment.

The generator circuit is 12 VDC. Twelve volts are supplied by a dedicated 12-volt battery. When two generators are installed, each generator has its own dedicated battery.

The battery banks are charged by one of the following sources:

- A.C. shore power via the converters.
- On-board generator via the converters.
- Main engine alternators.

Except for the momentary paralleling of the battery banks for starting the main engines, the two battery banks are completely independent of each other.

The generator itself charges the generator battery.

D.C. Power Distribution

This panel is located in the engine room and contains both main battery disconnect switches, the generator disconnect switch, windlass switch and fuse, parallel solenoid, emergency battery parallel switch, plus miscellaneous fuses for monitors, bilge pumps and power feeds to the distribution panels. The fuse descriptions are on the face of the panel.

The D.C. distribution panel, located in the salon, contains the port and starboard main and branch circuit breakers. Additionally this panel contains:

- A battery condition voltmeter, which allows you to read the voltage level of each battery bank.
- The holding tank monitor.
- The grey water tank monitor.
- The bilge flood monitor.
- The fresh water tank gauge, along with the pump restart switch.
- Additional blank locations for equipment that you may want to add at a later date.

D.C. Equipment Protection

CAUTION

Do not replace existing circuit breakers or fuses with devices having a higher trip value than those installed by the factory. Such modification could result in a fire or equipment failure.

A tripped circuit breaker or burned-out fuse may indicate a problem in the circuit or in the equipment protected by that device. If the same circuit breaker or fuse trips or burns out repeatedly, the cause must be determined and corrected to avoid possible equipment damage.

Battery Disconnect Switches

CAUTION

The battery disconnect switches are designed for use under normal operating conditions. If this switch opens the D.C. circuit while the engine is being started, the switch should be replaced as soon as possible to avoid future failure.

The main battery disconnect switches are located on the Main Supply Panel in the engine room. These switches connect and/or disconnect the batteries from the vessel's D.C. circuits. To activate the D.C. system, the main battery switches must be turned on. However, Bertram suggests that these switches be left in the off position whenever your vessel is unattended for long periods.

The main battery switches do not control the D.C. power from the converters. Whenever the shore power is connected and the main shore power circuit breaker and the A.C. converter circuit breakers are on, the converters will continue to charge the batteries. In addition, the main battery switches have no effect on the bilge pumps and fire/bilge flood monitors.

Battery Parallel System

There are two ways to parallel your batteries:

- Momentary battery paralleling to start the main engines.
- Emergency paralleling for use when an alternator fails, momentary paralleling solenoid fails, or the D.C. converter fails to charge both battery banks.

NOTE

The emergency parallel system is intended for emergency use only. If the batteries are paralleled, they will both charge and discharge at the same rate. Do not use this system on a continual basis because of the possibility of both battery banks going dead and leaving the main engines without a source of starting power.

12/24 VDC Voltage Equalizer

The voltage equalizer is a device that will keep both 12-volt batteries of the same 24-volt bank at an equal state of charge when uneven loads are applied to the individual 12-volt batteries of the 24-volt bank. This device draws amperes from the 24-volt battery bank to charge one of the 12-volt batteries of the same bank. The 12-volt battery being charged is the one at the ground (low) end of the 24-volt battery bank. Never connect a 12-volt load to the high end of the 24-volt battery bank.

A voltage equalizer is used when it is desirable to draw a 12-volt load from a 24-volt system, rather than installing a separate 12-volt battery and charging device. If an equalizer was not used, the battery bank would quickly become unbalanced and cause power and battery failure. A marine converter, when used alone, is not suitable for this type of charging, because it senses the over-all voltage of the 24-volt bank, and it is not capable of sensing unbalanced loads within the battery bank.

The system is protected by fuses in the 12-volt and 24-volt power feeds of the equalizer. The fuses are located at the source of battery power to the equalizer. There is also a push button circuit breaker on the equalizer to protect it from a short circuit.

Engine Room Ventilation

The natural ventilation system for your vessel is designed so that fresh air is drawn in through the air/water separators in the hull side vents and ducted down to the engine room. To supplement the natural air ventilation, there is also a thermostatically controlled forced air ventilation system.

The electric power for these blowers is connected to the blower circuit through a circuit breaker on the salon distribution panel. When the blowers are in their normal operating mode and the circuit breaker is turned on, the blowers automatically operate when the engine room temperature rises above 110 degrees and turn off below 90 degrees. The blowers have a manual override switch on the thermostat housing, which allows them to operate regardless of engine room temperature. This is valuable when working in the engine room.

Stateroom Ventilation

The foredeck hatch can be opened either partially or completely to bring fresh air into the stateroom area. This hatch is hinged at the aft end and has two pairs of locking dogs. Both sets of locking dogs are operated from inside the stateroom, and both sets can be dogged down to secure the hatch. The second pair of dogs are for added security and to ensure a watertight seal.

In addition to being a source of fresh air, this hatch also serves as an emergency egress hatch, if necessary.

Head and Shower Ventilation

Each head is equipped with an extractor, which is activated by a bulkhead-mounted switch. The exhaust blower lowers the humidity level by drawing away moist air from the shower and exhausting it overboard.

Galley Ventilation

- A 120-VAC extractor removes heat and cooking odors and ventilates the galley area.

Navigation Lights

NOTE

Your transom door must be kept closed while underway at night to gvoid obscuring the stern light. This door should remain closed at all times when underway to minimize the possibility of someone falling overboard.

All of the navigation lights furnished with your vessel meet the current 72 COLREGS requirements. However, it is the legal responsibility of the vessel's owner to ensure that in the event of modifications to the vessel superstructure, the required areas of visibility for each of these lights are not obscured.

Your Bertram is delivered to you with a complete set of navigation lights. These lights fully comply with the requirements of the International Regulations for Preventing Collisions At Sea (72 COLREGS). All vessels may use the 72 COLREGS as the controlling document when in international waters. In U.S. navigable waters, reference must be made to the Great Lakes and Western River Rules.

The 72 COLREGS require that the navigation lights shall be switched on if your vessel is being operated between sunset and sunrise, or in times of reduced visibility. For a vessel of this size, the required navigation lights consists of a red (port) and green (starboard) sidelight, a white masthead light, and a white stern light; or if you are not docked or anchored in a recognized anchorage, a white masthead light.

A.C. Electrical System

All of your vessel's A.C. equipment uses either 120- or 240-volt 60-Hertz power. When you are at sea, at anchor, or if you are docked where useable commercial power is not available, the onboard generator supplies your Bertram's electrical power. Where dockside power is available, your boat can use the 120/240-volt electrical power via the shore power cord.

This power is controlled and distributed from the 120/240-volt A.C. distribution panel in the salon. Depending on the model, you may have a distribution sub-panel in the galley or in the area of the companionway steps.

The frequency, voltage, and ammeters in the A.C. distribution panel monitor the power source in use.

NOTE

If your boat has been wired for 220-volt 50 Hz (European service), please disregard the references to 120/240-volt 60 Hz and the GFCI ratings.

CAUTION

If your boat is equipped with a rotary selector switch for selecting shore electrical power or ship's power, you must set all main circuit breakers to the off position before switching to or from shore power. Failure to do so may result in damage to the rotary switch and any A.C. motor.

To avoid circuit overloading, do not exceed the current draw of the shore power or the main generator circuit breakers.

Any A.C. electrical device may be damaged if the voltmeter reading drops below 110-volts or 220-volts.

A.C. Distribution Panel

This panel is divided into four general areas. Shore power/generator selection, power monitoring meters, generator controls, and circuit distribution.

Shore/Generator Selection

The selector switch (if equipped) or generator/shore main circuit breakers allow you to select between shore or generator electrical power. This area also has an ammeter with an L1 and L2 switch to monitor the load on both power leads of the 240-VAC (volts alternating current), a frequency meter, and a voltmeter. If your boat is over 45 feet, it may have two shore power cables and two generators. The general description in this chapter will still apply.

Generator Controls

This area contains the switches to start and shutdown the generator and a momentary battery parallel switch.

Circuit Distribution

This area contains the single pole 120-VAC and two pole 240-VAC branch circuit breakers for the A.C. circuits on your boat. A number of spare circuit breaker mounting plugs are provided for later circuit additions by your technician.

Loss of Power

Loss of electrical power may be caused by a shore system failure at the dock. An A.C. main shore power breaker in the cockpit may have tripped. An A.C. branch circuit breaker may have tripped or the generator main breaker on the generator control box may have tripped.

A.C. Generator System

To satisfy your vessel's A.C. power requirements while underway, your vessel has one or two generators. They are located either in the engine room, or the machinery room aft of the engine room.

The generator controls located on the salon A.C. distribution panel gives you control over the generator operation.

Please be certain to read the manual provided by the generator manufacturer for complete operation and maintenance of the unit.

Starting the Generator

Before starting the generator, do the following:

- Check the generator cooling water seacock to be sure it is open.
- Check the sea strainer for debris.
- Check the coolant level in the heat exchanger.
- Check the lube oil level.
- Check that the generator main disconnect switch is on.
- Set both the port and starboard main battery disconnect switches to on.

CAUTION

If the generator does not start after several attempts, its waterlift muffler may have filled with water. In order to prevent seawater from entering the generator engine and causing serious damage, unscrew the muffler drain plug and drain the muffler.

When attempting to start the generator, do not exceed 20 seconds of cranking. Wait 2 to 3 minutes before trying again.

You can select the generator power source by turning off the shore power breaker on the panel, move the protector slide toward the shore power breaker, and turn on the generator main breaker. If your vessel is equipped with a rotary selector switch, be sure the main circuit breakers are off, and turn the rotary switch to the generator position.

If your vessel has two generators, you can operate on one generator only. You must, however, limit the amount of amperage draw by turning off unessential equipment. You can also operate both generators and split the total amperage draw between the generators. To do this, turn one rotary switch to generator #1 and the other rotary switch to generator #2.

Do not allow either generator to run in standby without a load.

Stopping the Generator

Before stopping the generator, remove all loads by turning off the main A.C. breakers. Push the momentary start/stop switch to the stop position.

Your generator has an automatic shutdown system that stops the generator before any fault damages the unit. Your generator will shutdown for the following reasons:

- ✓ High exhaust temperature
- ✓ High water temperature
- ✓ Low oil pressure

A.C. Shore Power

WARNING

TO MINIMIZE SHOCK HAZARD, UNPLUG THE SHORE POWER CABLE AND CLOSE THE INLET COVER TIGHTLY. DO NOT ALTER THE SHORE POWER CABLE CONNECTIONS.

DO NOT CUT OR DISCONNECT THE GREEN GROUNDING CONDUCTOR IN THE SHORE CORD OR AT THE DOCK OUTLET. THIS CONDUCTOR IS NEEDED TO PROVIDE THE SAME GROUND POTENTIAL BETWEEN THE SHORE GROUND AND YOUR BOAT'S GROUND AND MINIMIZES THE SHOCK HAZARD TO PEOPLE ON THE BOAT OR IN THE WATER.

CAUTION

Before connecting or disconnecting the shore power cord, ensure that the main shore power circuit breaker is switched off or that the power selector switch is off. This will help to prevent connector arcing and damage. The shore power cord is a twist-to-lock fitting. Ensure that this fitting is properly locked-in place before switching the main shore power breaker to the on position. This will help to prevent arcing. The shore power inlet is rated at 50 amperes. To protect your dockside shore power cord fitting, do not exceed 50 amperes current draw.

Your Bertram has a standard Cablemaster shore cord and reel assembly. The shore cord and its plug are accessible from inside a weather-tight receiver in the cockpit. The shore power feeds into the A.C. power selector switch, as previously described.

Circuit Protection

CAUTION

Do not replace an existing circuit breaker or fuse with one of a higher rating. Such modification could cause equipment and/or circuit failure and fire.

A tripped circuit breaker or blown fuse may indicate a problem in that circuit or in equipment protected by that breaker or fuse. If the same protection device repeatedly trips or burns out, the cause must be determined and corrected to avoid possible equipment damage. As stated in the above **caution**, under no circumstances should any circuit breaker or fuse be replaced with one of a higher value.

Ground Fault Circuit Interrupter (GFCI)

To reset the tripped GFCI outlet, depress the red reset button until it locks in place. If the button will not reset, there may be a problem with the appliance in use or with the circuitry.

Circuit breakers on this vessel protect onboard equipment and circuits from overloads and short circuits. However, circuit breakers may not protect people from electrical shock. Ground fault is a leakage of current to ground, often through the body of a person who is the electrical path to ground. It is the most common type of current leakage responsible for electric shock accidents.

Your Bertram is equipped with Ground Fault Circuit Interrupters protection in the galley, heads, wet deck areas, and the engine room.

Except for a red reset button and a black test button located between the two outlets, GFCI receptacles look similar to unprotected receptacles.

Each GFCI outlet is a standard duplex 120-VAC outlet, except that if the GFCI outlet senses six or more milliamperes of ground fault current, this outlet will act as a circuit breaker and open the circuit. If this occurs, the reset button will pop out. If this continues to occur, a marine electrician should be consulted.

To test a GFCI outlet, depress the black test button. The red reset button should pop out. If it does, depress the reset button until it locks in place. If the reset button does not pop out, have the receptacle and the circuit tested by a marine electrician.

Galvanic Isolator

A grounding conductor is not normally a current-carrying conductor. However, there are abnormal conditions when an A.C. current may flow through this conductor. Two of the possible conditions are:

- A breakdown of the insulation between a current-carrying conductor and the ground conductor
- Incorrect or inadequate wiring on shore or on your vessel

To minimize the electrical shock hazard when your vessel is connected to shore power, the shore power green grounding conductor is electrically connected to the vessel's grounding system. This, in effect, electrically connects your vessel's underwater metal fittings (through the bonding system) to the shore A.C. grounding system and to the other vessels, which are connected to the same shore power system. This condition can cause difficulties, in that your expendable zinc may be overloaded to a point where it cannot provide sufficient protection against electrolytic corrosion. To stop the overload, the electrical path must be blocked, without cutting the green grounding conductor in your shore power. To do this, a galvanic isolator is wired in series with the green grounding conductor.

The U.L. listed **galvanic isolator** in your Bertram is a solid-state device designed to stop the accelerated underwater corrosion that can occur when your vessel is dockside and connected to shore power. The galvanic isolator is a passive unit that requires no maintenance and acts as an electrical filler to prevent the flow of D.C. current through the green grounding conductor, without sacrificing the safety features of the grounding system.

International Shore Power

CAUTION

A 220-volt 50 Hz system will not operate safely on a 120/240-volt 60 Hz system, nor will a 120/240-volt 60 Hz system operate safely on a 220-volt 50 Hz system.

If this vessel will be operated in foreign ports that have shore power of 220-VAC 50 Hz, Bertram's International Option must be ordered early in the production schedule. The international system is a 2-wire 220-VAC 50 Hz system with a ground system designed for foreign ports. All standard equipment is changed from 120/240-volt 60 Hz to 220-volt 50 Hz. The generator would also be changed to a 220-volt 50 Hz unit. 120-VAC power is not available with the foreign port option.

Automatic Converters

The onboard A.C. to D.C. converters change the A.C. input power to D.C. output, which charges the appropriate battery bank. The converters are completely automatic and will maintain the batteries in a fully charged condition. It is recommended that the converters be left in the "On" position at all times.

NOTE

Because the converters are always on, it is important to monitor the electrolyte level in the batteries on a regular basis.

Telephone & Cable TV

Your Bertram is equipped with a standard telephone jack and cable television connection. The inlet is located in the pilaster locker.

FIRE MONITOR AND EXTINGUISHING SYSTEMS

NOTE

Some models do not have duplicate readouts because of the vessel's particular configuration.

Boating safety studies show that the best way to fight shipboard fires is to prevent them. Most shipboard fires are preventable by these obvious steps:

- Do not allow fuel spillage to accumulate in the bilge.
- Store paint and other combustible materials properly.
- Take appropriate care when cooking, especially frying.
- Take appropriate care with smoking materials.
- Do not exceed the safety factor built into the electrical wiring.

Unfortunately, onboard fires do occur. Boating safety statistics* indicate that unless the fire is extinguished within the first 5-10 minutes, 80% of all pleasure craft are destroyed.

To provide you with fire-fighting capabilities, the following equipment is included as an essential part of your Bertram:

- Engine room fire monitor (overheat detection).
 - Engine room fixed fire extinguishing system with a fire extinguisher discharge monitor.
 - Portable hand-held fire extinguishers.
- DOT U.S.C.G. COMDTINST M16754.1G "BOATING STATISTICS"

NOTE

The fire monitor system monitors your vessel for fire (overheat) in the engine room only. The fire system monitor is separate from the onboard fixed fire extinguishing system. The fire system monitor will not detect fire outside of the engine room. The combination fire and bilge flood monitor is tested and silenced using the same switches and controlled by the same power fuses. It can be disabled completely by removing the fuse in the D.C. main supply panel located in the engine room or machinery room, depending on the model.

Fire System Operation

If an overheat condition occurs, the red indicator light will illuminate and the alarm will sound, indicating an overheat condition in the engine room.

Acknowledge the condition by briefly pressing the silence button located at the flybridge helm station or the button on the D.C. distribution panel in the salon. The alarm horn will stop sounding. The indicator light will remain illuminated until the heat detectors reset themselves.

The monitor system can be tested at any time by pressing the monitor test button located on the helm station control panel. When the button is pressed, the light will illuminate, and the alarm horn will sound. Releasing the button will cause the light to go out, and the horn will stop sounding. An open circuit in the heat detection system wiring will also cause the monitor to respond as if there is an overheat condition.

Engine Room Fixed Fire Extinguishing System

READ VERY CAREFULLY

WARNING

TOXIC BY-PRODUCTS ARE PRODUCED WHEN THE FIRE-FIGHTING AGENT (FE-241) EXTINGUISHES THE FIRE. AVOID BREATHING THE FUMES.

INHALATION OF FE-241 (chlorotetrafluoroethane) IN HIGH CONCENTRATIONS MAY CAUSE DEATH WITHOUT WARNING. READ THE MANUAL PROVIDED WITH THE FIRE EXTINGUISHING SYSTEM FOR COMPLETE INFORMATION.

MOST FIRE-FIGHTING AGENTS WILL STOP ENGINES BY OXYGEN DEPLETION. AGENT FE-241 MAY NOT STOP YOUR ENGINES OR GENERATOR. IF THE ENGINES ARE NOT STOPPED QUICKLY, THE FIRE-FIGHTING AGENT CONCENTRATION MAY BE RAPIDLY REDUCED AND ELIMINATED AS AN EFFECTIVE FIRE-FIGHTING AGENT.

IN ORDER TO GIVE FE-241 A CHANCE TO EXTINGUISH A FIRE, THE CONCENTRATION MUST REMAIN AS HIGH AS POSSIBLE. DO NOT OPEN THE ENGINE ROOM ACCESS HATCH.

THE FIXED FIRE EXTINGUISHER WILL FIGHT FIRES ONLY IN THE ENGINE ROOM. FIRES OUTSIDE THE ENGINE ROOM SHOULD BE FOUGHT WITH THE PORTABLE HAND-HELD EXTINGUISHERS.

Your vessel has an automatic/manual fixed fire extinguishing system. The system consists of a FE-241 gas agent bottle along with its controls and indicators. The bottle is located in the engine room. The indicator and engine shutdown override control switch is located at the helm station on the flybridge. The manual discharge "T" handle and a second discharge light are located in the cockpit pilaster locker on the starboard side. Please read the fire extinguisher system operation manual for complete instructions.

System Operation

The first indication of an over-temperature condition will usually be the fire monitor horn and indicator light. When the temperature rises rapidly due to a fire, there may be only a brief time span between the monitor indication and the discharge of the fixed fire system.

When the fire system is automatically or manually discharged, it will:

- Y Shut down the forced air ventilation system.
- Y Shut down both main engines.
- Y Shut down the generators.
- Y Release the FE-241 fire-fighting agent.
- Y Initiate the system alarm and indicator light.
- Y Close the air intake vents on the intake plenums automatically, if your vessel was built to RINA (Registro Italiano Navale) standards, or is over 67 feet.

WARNING

EVERYONE ABOARD MUST IMMEDIATELY DON LIFE JACKETS (PFDs), MOVE TOPSIDE, PROCEED QUICKLY AND SAFELY TO A LOCATION FURTHEST FROM THE FIRE, AND REMAIN THERE AS A GROUP. THIS SHOULD BE DONE BEFORE CHECKING THE CONDITION OF THE VESSEL. GATHER ALL PORTABLE HAND-HELD FIRE EXTINGUISHERS IN THE COCKPIT. IF THERE IS AN ENGINE ROOM FIRE, DO NOT WAIT FOR THE SYSTEM TO DISCHARGE AUTOMATICALLY. DISCHARGE THE SYSTEM MANUALLY FROM THE COCKPIT BY REMOVING THE SAFETY PIN AND PULLING THE DISCHARGE "T" HANDLE.

NOTE

Depending on the rate of rise in temperature, the time between the fire monitor system alarm and the fixed system discharge may be too short to be acted upon as separate events. Automatic discharge of the fire system cannot be defeated. It will always discharge at its designed discharge temperature.

After Discharge of the Fire System

WARNING

DO NOT OPEN THE ENGINE ROOM ACCESS HATCH, OR TRY TO ENTER THE ENGINE ROOM, FOR AT LEAST 15 MINUTES AFTER THE FIRE AGENT HAS DISCHARGED. THIS WOULD ALLOW OXYGEN TO ENTER THE ENGINE ROOM BEFORE HOT METALS AND/OR FUELS COOL, WHICH MIGHT CAUSE RE-IGNITION AND FLASHBACK.

NOTE

Except in the rare case of coincidental emergencies (more than one at one time) requiring immediate power to maneuver your vessel out of the way of danger from another source, you must allow the fire-fighting agent sufficient time to extinguish the fire completely.

If you hear the fire extinguisher discharge alarm, the fire system has discharged. Take these steps immediately:

- Have everyone aboard don a life jacket and move quickly and safely away from the fire.
- Assign one person to be in charge of your abandon ship bag, which should include a fully charged hand-held VHF radio, emergency flares, dye markers, bottled water, and anything else needed to survive at sea.
- **Contact the Coast Guard on VHF channel 16 (156.800 MHz) or SSB radio frequency 2182 kHz. Say, "MAYDAY, MAYDAY, MAYDAY!" Describe the situation. Describe the vessel. Give your location and the number of people aboard.**
- If you have an emergency life raft, prepare it for deployment.
- If you have a tender, launch it immediately, before you lose electrical power.
- Unless other dangers make maneuvering power necessary, immediately shutdown both engines, if the automatic system has not already done so.
- Shut down all electrical power except for the bilge pumps, navigation lights, and VHF or SSB radios.
- Extinguish all open flames.
- Do not open the engine room access hatches for at least 15 minutes.
- Verify that the fire is totally extinguished by carefully feeling around the hatches and bulkhead to ensure that these surfaces are cool before opening any hatches.
- Stand by with portable hand-held extinguishers, in case the fire spreads past the engine room or re-ignites.

The Firefighting Plan

After an active fire prevention program, a well-thought out and well-rehearsed vessel fire-fighting plan is the next most important step towards organizing the fire-fighting efforts of the vessel operator, the crewmembers, and the passengers. Such organization is vital since studies of fires at sea show that a quick reaction time is absolutely essential to extinguishing shipboard fires. Therefore, the vessel operator, as well as other designated persons onboard, must be thoroughly familiar with the following:

- Location of the life jackets (PFDs).
- Location of the switches to shutdown the engines, generators, D.C. power supply, and ventilation blower system.
- Location and use of every hand-held portable fire extinguisher onboard, as well as which type of fire it should (and should not) be used on.

Inspection and Restarting of the Vessel's Systems

WARNING

THE COMBUSTION BY-PRODUCTS OF FE-241 ARE TOXIC. WAIT FOR THE NATURAL VENTILATION TO COMPLETELY EXCHANGE THE ENGINE ROOM AIR BEFORE ENTERING.

After The Fire Has Been Extinguished

- Silence the fire monitor system by briefly pressing the silence button on the flybridge or salon D.C. electrical panel. The light will remain illuminated until the heat detectors reset themselves.
- Use the fire system manual override switch to allow switching on the blowers, generators, and main engines.
- Ventilate the engine room to remove any unburned FE-241.
- Have the proper type of USCG hand-held fire extinguishers ready before you cautiously open the engine room access hatches.
- Carefully examine the engine room for damage and determine the cause of the fire.
- Make the necessary emergency repairs, making certain that none of the seawater cooling intake hoses for the main engines are burned through.
- If your vessel was built to RINA (Registro Italiano Navale) standards, or is over 67 feet long, you must manually reopen the air intake shutters located on the intake plenums outboard of each engine.
- Start your engines.
- Turn on only those electrical circuits necessary to maneuver your vessel safely.
- **If you have alerted the Coast Guard, inform them that the fire has been extinguished and you are able to get underway under your own power.** Contact them again when you are safely secured at your destination.
- Continue to the nearest port.
- Have the fixed fire extinguisher system and any hand-held fire extinguishers serviced as soon as possible.

Classes of Fires

For the purpose of selecting the correct fire-fighting tool, fires are divided into the following classes:

Class "A" Fires

Class "A" fires are fueled by paper, wood, fabric, rubber, and some plastics. Water is the best means of extinguishing class "A" fires. Drench the fire. Open the material to expose all burning embers and re-drench. You may tie a line around the smoldering material and throw it overboard until you are certain the fire is out. Then retrieve the material and stow it in the cockpit until you return to the dock.

Class "B" Fires

Class "B" fires are fueled by flammable liquids, gasoline, oils, paint, and cooking fats. Carbon dioxide and dry chemical extinguishers are suitable agents to use on class "B" fires. A firefighter should aim his extinguisher at the base of the fire, not at the smoke, working in a horizontal sweeping motion from the front of the fire to the back.

Class "C" Fires

Class "C" fires are caused by energized electrical equipment. Carbon dioxide and dry chemical fire extinguishers will extinguish class "C" fires. **Class "C" fires must never be fought with water.** Water will cause more short circuits and more fires and will endanger the life of the firefighter by electrocution.

Galley grease fires may be fought with dry chemical extinguishers, baking soda, or covering the fire; but **never** with water, which will splatter the hot grease and possibly spread the fire.

WARNING

NEVER ATTEMPT TO DISABLE ANY PART OF YOUR FIXED FIRE EXTINGUISHER SYSTEM. THIS SYSTEM CONTAINS LIQUEFIED GAS AT HIGH PRESSURE AND SERIOUS INJURY OR DEATH COULD RESULT.

PERFORMANCE

Hull Efficiency

Your Bertram is designed to carry comparatively heavy loads without appreciably reducing performance. However, for the best performance results, you should maintain the original trim, which is with a slight bow up attitude. Therefore, we suggest that you become familiar with how the vessel behaves, especially the visual relationship between the bow and the horizon.

All gear and equipment onboard should be properly stowed while underway. Be aware that the more personal gear and accessories are placed aboard, the greater the decrease in the vessel's speed, and the greater the amount of exhaust smoke and soot.

Marine Growth

To obtain the maximum hull efficiency, the hull bottom of your vessel must be kept free of marine growth. Even a slight amount of growth will increase resistance, thus decreasing performance and efficiency. In most cases, keeping the bottom free of growth will require a trained diver to clean the hull bottom. Depending on local conditions, in order to maintain maximum efficiency, this may need to be done once a month, or even more frequently. A diver will also have to clean the water intakes and all hull bottom mounted equipment to insure that all marine growth is clear and that all intakes and equipment are working properly. Failure to keep the hull bottom clean is one of the leading causes of owner complaints. Keeping the hull bottom clean is solely the responsibility of the owner.

Water in the Bilge

The bilges should be kept as dry as possible to minimize excess weight. The added weight of bilge water causes the vessel to ride lower in the water, which increases resistance. This increased resistance reduces your vessel's speed and increases fuel consumption. Another consequence of excess bilge water is called the free-water effect. As the bilge water "sloshes" from side to side, it may influence the amount of roll at low speeds, or make it difficult to trim the vessel at higher speeds.

Atmospheric Conditions

There are some operational considerations to keep in mind. Engines develop slightly less horsepower in warm air. Therefore, a vessel that departs cooler climates and proceeds to warmer, more humid air may not perform the same as it did in the cooler climate.

CONTROL, MANEUVERING, & SAFETY

Main Engines

NOTE

Each time before you start the main engines, it is important that you check the lubricating oil level, the coolant level, and the transmission oil level. This is also a good time to check the fluid level and pressure in your steering system.

Each engine package, even from the same manufacturer, may have slightly different operating procedures. Therefore, specific information on engine operation is not contained in this operation's manual. Refer to the engine manufacturer's operators manual.

For emergency manual operation of electronically controlled gears, please refer to the transmission operation manual

CAUTION

To avoid possible serious engine damage, do not attempt to start or operate your engines until you have read and understood the engine manufacturer's operators manual.

Before starting the engines, ensure that the transmission controls are set in neutral.

Exhaust System

CAUTION

If your vessel is equipped with a heat retention blanket, it must be kept in place at all times during engine operation to prevent serious burns or combustible material from coming into contact with the hot surfaces and causing a fire. It is not uncommon for the heat retention blankets to deteriorate, due to the extreme temperature. If you see that the blanket is deteriorating, have it replaced immediately.

Engine Instruments

Your Bertram has two identical sets of engine monitoring instruments, one set for each engine. The instruments purpose is to assist you in the efficient operation and proper maintenance of your boat. Therefore, you should:

- Become familiar with the function of each instrument.
- Make it a habit to scan the instruments frequently when underway.
- Pay particular attention to the instruments when first starting the engines.
- Make a note of what constitutes normal operational pressures and temperatures.

NOTE

If your boat is equipped with electronic engine displays, the remainder of this section may not apply. Refer to the engine manuals supplied by the engine manufacturer.

Engine Coolant Temperature

The coolant temperature gauges indicate the temperature of the coolant circulating through the engines. Any sudden rise in the coolant may indicate an engine cooling system malfunction. The engine should immediately be brought to idle and shut down until the cause is determined.

Possible causes:

- Low coolant level in the heat exchanger
- Water flow restricted at the hull bottom sea strainer
- Defective coolant pump
- Defective seawater pump impeller
- Defective thermostat

WARNING

TAKE EXTREME CARE WHEN ENTERING THE ENGINE ROOM TO DETERMINE THE CAUSE OF THE OVERHEATING CONDITION. HOT COOLANT MAY HAVE ESCAPED FROM THE COOLING SYSTEM, MAKING THE ENGINE ROOM SOLE SLIPPERY.

HOT COOLANT MAY SPRAY FROM THE ENGINE UNDER HIGH PRESSURE.

Engine Lube Oil Pressure

Any rise or drop in the lube oil pressure could indicate a major engine problem. Return the engines to idle and shut them down.

Possible causes:

- Low lube oil level
- Overheated lube oil (restricted lube oil cooler)
- Defective lube oil pump

Gear Oil Temperature

A rise in the gear oil temperature may damage the transmission. Return the engines to idle, shift into neutral, and determine the cause of the high temperature.

Possible causes:

- Low gear oil level
- Clutch plate slippage
- Restricted gear oil cooler

Gear Oil Pressure

A decrease in gear oil pressure may cause serious transmission damage. Immediately return the engines to idle and shut them down.

Possible causes:

- Overheated transmission
- Low gear oil level
- Defective gear oil pump

D.C. Voltage

The voltmeters allow you to monitor the voltage in the battery banks. The normal operational range for a 12-volt battery is from 12.5 to 14.1 volts. The normal range for a 24-volt system is from 25.0 to 28.2 volts.

Possible causes:

- Defective engine alternator
- Low battery water
- Corroded battery terminals
- Batteries are near the end of their service life

Tachometer

The tachometers measure engine speed (not propeller shaft speed) in Revolutions per Minute (RPM). Diesel engines perform best when they are at relatively constant speeds. Therefore, a substantial change in either the engine RPM from a fixed power setting or a decrease in the maximum RPM may be an indication of a problem.

Possible causes:

- Poor fuel supply
- Hull bottom has become fouled with marine growth
- Contaminated fuel from water, algae, etc.
- Propeller damage
- Hot, humid weather conditions
- Restricted engine room air intake
- Restricted air filters
- Significant increase in the vessel's displacement
- Bilge flooding

NOTE

It is strongly recommended that you study and become familiar with the engine manufacturer's operator's manual.

Steering Control System

Maneuvering by shifting gears is for docking and similar minimum speed maneuvers. For maneuvering at normal cruising speeds, your Bertram is equipped with a positive-control, no-kickback, pressurized, hydraulic steering system.

The steering system consists of:

- An axial, piston-steering station helm pump
- A pressure-relief valve
- Two double-action slave and steering cylinders
- A reservoir with a sight glass
- A steering system pressure gauge
- An engine-mounted, power-steering pump (if equipped)

When you turn the helm, the axial piston pump forces hydraulic fluid into either side of the single action, unbalanced steering cylinders attached to the rudder arm. The piston pushes or pulls the rudder from amidships. The rudders are secured to each other with a tie-rod.

From the steering cylinders, the hydraulic fluid is piped to the relief valve. The relief valve is equipped with the system purging valves and filters. From the relief valve, the hydraulic fluid is piped to the reservoir. The reservoir has a system pressure gauge, air pressure inlet, and fluid fill port. This steering system is designed and built specifically for marine use, and is designed to prevent any outside air from entering the system. If needed, the steering system's air pressure can be re-charged by using an ordinary bicycle pump.

NOTE

If your Bertram is equipped with electronic "fly by wire" steering, the circuit breaker located inside the bridge helm console should be turned off when the steering system is not needed. Unless the circuit breaker is turned off, the power steering pump will continue to operate and may shorten the life of the power assist.

If the electric power assist should become disabled, it is still possible to steer the vessel. However, it will require more turns of the steering wheel to accomplish the same degree of rudder angle; approximately 10 turns lock-to-lock.

Trim Tab Controls

WARNING

BEFORE ENTERING AN INLET OR RUNNING AHEAD OF A FOLLOWING SEA, RETRACT THE TRIM TABS TO THE FULL UP POSITION. FAILURE TO DO SO MAY RESULT IN BROACHING OR PITCH POLLING

NOTE

Do not press both the "bow down" and "bow up" switches at the same time. Do not hold the switches down for an extended period, as this will cause the circuit breaker to trip.

Do not shift into reverse or back down unless both trim tabs are completely retracted. It is possible that water pressure against the trim tab could damage the cylinders or the trim tab planes.

Each time you make a significant speed change, you may need to readjust the trim tabs. As the speed increases, less trim tab is required to maintain a constant trim angle.

Too much bow down trim may induce "bow steer" and degrade the handling of your vessel.

The trim tab system is electro-hydraulic and receives power from the D.C. breaker panel inside the bridge console. The two trim tabs can adjust your vessel's fore and aft underway trim in the same way that flaps help an aircraft maintain the proper flight attitude. The trim tabs can also adjust the port and starboard list caused by the wind or unusual load conditions.

A rocker-type switch mounted on the console activates the trim tabs. The top of each rocker is marked with the words "bow down". Depressing the switches in the bow down position causes the trim tabs to extend and force the bow down. Depressing the switches in the bow up position retracts the trim tabs and allows the bow to rise. In a head sea condition, the ride sometimes can be softened by depressing the switches toward the bow down position and lowering the bow. **Remember, you should never extend the trim tabs (bow down) in a following sea.**

While underway, you may find that your vessel lists to port or starboard. Improper loading or a beam wind usually causes this. You can correct the list by pressing one of the trim tab switches. If your vessel is listing to port, depress the starboard switch until the list is corrected. If your vessel is listing to starboard, depress the port switch.

Engine Control & Maneuvering

NOTE

An acrylic cover protects your instruments and switches. The switches are weatherproof but not waterproof. Electrical damage may result if water gets behind the cover.

CAUTION

Carefully read all of the information contained in the operator's manual for the type of engine and transmission controls installed in your vessel before you attempt to get underway. Failure to do so may result in injury and damage to your vessel and vessels nearby.

Before attempting to start your engines, confirm that all engine and control circuit breakers, located on the 24-VDC panel inside of the console, are switched on. If the main engine circuit breakers are switched on, and the electronic control circuit breakers are switched off, it may be possible to start the engines with the transmission in gear.

The main navigation and engine control console is equipped with the following:

- ✓ Engine, transmission, and steering controls
- ✓ Engine performance instruments
- ✓ Engine and accessory switches
- ✓ Fuel gauge
- ✓ Battery condition gauges
- ✓ Fire and bilge flood monitor lights and alarms
- ✓ Generator operation indicator lights
- ✓ Bow thruster joystick (if equipped)
- ✓ Trim tab activation switches
- ✓ Anchor windlass control (if equipped)
- ✓ Navigation/anchor light switch
- ✓ Horn switch

Aft Control Station (If Equipped)

CAUTION

The aft control station has little or no forward visibility. Do not use this station unless you have a lookout posted on the bridge.

While Underway

WARNING

WHILE UNDERWAY, DO NOT ALLOW ANYONE TO MOVE TO OR FROM THE FOREDECK. DO NOT LEAVE THE TRANSOM DOOR OPEN.

Prudent Boat Speed

Your Bertram's deep "V" hull cushions wave impact by slicing through the waves, rather than pounding against them. However, even a Bertram will eventually encounter extreme conditions that a prudent seaman must not ignore. Your speed should be reduced, as required by adverse sea conditions, in the interest of your comfort, safety, and needless strain on the engines and boat structure. Always obey the posted speed limit and "no wake" regulations.

Slow Speed Maneuvering

Your Bertram's twin counter-rotation propellers and twin rudders make her a pleasure to maneuver, even at idle speeds. For example, to turn your boat in her own length in a confined area, place one engine in forward, and the other in reverse with the rudder amidships, and the throttles at or near idle. This turn can be made in any direction. With the port engine in forward and the starboard in reverse, you will turn clockwise. With the port engine in reverse and the starboard in forward, you will turn counter-clockwise. If desired, you can speed up the turn by applying rudder and/or throttle in the direction of the turn.

Cruising Speed Maneuvering

Your Bertram's rudders are in fact lifting surfaces, similar to an aircraft wing. At speed, when you put the rudders over, a lifting force is generated as the water passes over the high- and low-pressure sides of the rudders at different speeds. This lifting force pushes your stern out and away from the direction of the turn. For instance, when getting underway from a dock on your starboard side, if you were to put the helm hard over to port in an effort to move your bow away from the dock, your rudder position would push your stern into the dock.

You should be aware that there is a practical limit to how far you can turn a rudder, after which it simply produces drag. This is why the rudders on your boat are limited to approximately 22 degrees port and starboard from amidships.

When you begin a turn, your vessel pivots around a point forward of amidships. The pivot point changes with speed, and forward and aft trim. The bow pivots around a circle that is slightly smaller than that of the stern, with the bow just inside the intended turning track and the stern just outside of the track.

High Speed Caution

Under certain conditions such as: reduced fuel load, shallow water, high speed, and a trimmed down by the bow attitude, the boat may experience a ground effect phenomenon. Whereby, the boat is forced to ride higher in the water due to the incompressibility of the water beneath the hull. Should this phenomenon occur, the boat might experience a sudden and drastic list to one side. To prevent this from happening, it is prudent to operate at reduced speeds when the above conditions are present.

Compass

CAUTION

The compass aboard this vessel has not been compensated. Compass compensation is the responsibility of the boat owner and should be performed by a competent compass technician.

The addition or removal of any electronic equipment or gauge in the instrument panel, or in the immediate vicinity of the compass, may have an influence on compass deviation.

The compass installed on your boat is a magnetic card compass. Like all magnetic compasses, it is affected by:

- Nearby ferrous objects (steel and iron).
- Magnetic fields generated by nearby electrical or electronic equipment, including other compasses.
- Variations in the earth's magnetic field.

The compass can be the most important navigational instrument on a vessel. A compass is, basically, a permanent magnet, free to swing into alignment with the influence of existing magnetic fields.

Variation

Local variation is the angular difference between magnetic North and true North. Variation is expressed in degrees East or West of true North and is not affected by your vessel's heading. It ranges from about 0 degrees to about 20 degrees East or West error, depending on your global position.

This variation is the world's magnetic field shifting continuously and irregularly, so magnetic North moves slightly each year. You will find local variation readings printed on current navigation charts, which is why it is important to keep your charts up to date.

Deviation

Objects in the immediate vicinity influence every compass. Deviation is the angular difference between the reading your compass provides as installed and the reading it would provide if the objects were not there.

Deviation is caused by such shipboard influences as your engines, electric motors, instruments with meter movements, electronic equipment, speakers, and other objects placed near the compass.

Deviation is expressed in degrees East or West of true North. It varies with the heading of your vessel, because as your vessel turns, the position of the objects that affect the compass change relative to magnetic North.

You must record deviation of the compass on a compass deviation card and place it near the compass. You must record the deviation for each individual compass that you use, because the position of each compass relative to the materials around it determines the deviation.

Your compass is fitted with a set of compensation, or adjustment, screws to minimize these errors. It is seldom possible to compensate for all compass deviation errors, since this type of error varies as the heading of your vessel varies. However, the error should remain the same for any given heading, as long as no changes are made to the instruments and electronics near the instrument panel.

There is a vertical mark on the compass called a "lubber line". This line was oriented when your compass was installed, so an imaginary line drawn from the compass pivot point to the lubber line will be parallel to the longitudinal axis of your vessel. Thus, your vessel's course is the compass card reading below the lubber line.

Draft

To avoid running aground and damaging your underwater gear, it is absolutely vital that you know exactly how much water your vessel draws (draft). Any vessel's draft varies depending on her load and the salinity and temperature of the water. A vessel will draw slightly less in saltwater than in fresh. We suggest that you determine the draft with the vessel at or near the maximum load that you intend to carry. To determine the draft:

- Measure the freeboard (hull height above the water) from the top of the covering board to the water line at the center of the transom.
- Subtract that measurement from the dimension given for the distance from the covering board to the bottom of the propeller as noted in the docking plan (supplied in this manual) to determine the vessel's draft at the transom.
- Record this dimension where it will be readily available.

Grounding

CAUTION

When aground, do not attempt to drive the vessel off. Trying to re-float a vessel under its own power could result in damage to the propellers, propeller shafts, struts, and transmissions.

Do not run the engines while aground. Sand, dirt, and foreign matter could be drawn into the main engine and generator cooling systems.

The odds are that eventually you will either run aground or hit a piece of floating debris (flotsam). If either of these happens, take the following steps to protect your vessel and minimize any damage.

If You Are Aground:

- Resist the impulse to shift into reverse and back off.
- Shift both transmissions into neutral and shutdown both engines.
- Determine if any damage has occurred to the hull or driveline.
- Remember, the wind and/or current may turn the vessel broadside to the shoal.
- If possible, rig an anchor off the stern to prevent the vessel from broaching or being driven harder aground.
- If you grounded at low tide, you may be able to wait for the tide to rise, and float the vessel off.

If You Have Struck Flotsam:

- ✓ Return the engines to idle.
- ✓ Shift both transmissions into neutral.
- ✓ Determine if you have sustained any driveline damage or hull damage.
- ✓ If you determine the damage is minor, scan the water forward and aft, and attempt to back out of the danger area.
- ✓ If you have sustained hull damage and are taking on water, contact the Coast Guard.
- ✓ If the driveline is severely damaged, call for towing assistance.

Recommendations for Re-floating a Vessel

Most vessels run aground at the bow. Unless your vessel has received hull damage that requires repair before re-floating, the most important thing is for you to avoid damaging your propulsion system, or being driven further ashore, and for you to prevent possible damage from pounding or broaching.

Pounding

Pounding occurs when each wave raises a grounded vessel's hull and drops it against the seabed. Bottom damage from pounding can range from cracking the fiberglass to opening serious holes in the hull. As each wave strikes against the vessel, the continuing wave action tends to drive the vessel further aground.

Broaching

Broaching is the most serious problem a grounded vessel may face and occurs when the vessel is thrown or turned broadside to the shore or shoal by waves. Broaching is dangerous for two reasons. First, broaching continually drives the grounded vessel harder aground. Second, currents are set up around the grounded vessel's bow and stern. These currents tend to scour sand away from under the vessel's hull, piling the sand up amidships and to the leeward of the vessel, eventually leaving the hull supported only amidships. This can break the vessel's back.

Staying Afloat

The first step is to determine the location and extent of any hull damage. Bertram hulls are among the strongest made, but running any vessel onto sharp coral or a rock can damage it.

If necessary, make a patch using one or more of the two-part emergency, fast-setting epoxy patch kits, readily available at marine hardware stores. These patches can be applied to almost any hole from either inside or outside your hull. At least one of the kits should be part of your emergency gear.

You may wish to set one or more stern anchors as quickly as possible to prevent broaching or being driven further ashore.

Damaged Underwater Gear

CAUTION

Only under emergency conditions should your vessel be operated at cruising speed with vibration-caused damage to underwater gear.

Height Above the Waterline

Besides knowing your vessel's draft, it is also vital to know her height above the waterline. This measurement should be taken with the vessel in her lightest condition.

Towing

WARNING

DO NOT SECURE TOW LINES TO DECK CLEATS, WHICH ARE FOR MOORING ONLY. CLEATS ARE NOT FASTENED TO YOUR VESSEL FOR TOWING.

TAKE ADDED CARE IF TOWING, OR BEING TOWED, WITH NYLON LINES. THESE LINES STRETCH, AND IF A FITTING FAILS OR THE LINE PARTS, THE END CAN SNAP BACK WITH SUFFICIENT FORCE TO CAUSE INJURY OR DEATH.

Although a common courtesy, towing is not recommended, since it can be dangerous to the occupants of both vessels. Towing is best left to professionals. Most towing accidents fall into one of three categories.

- ✧ Most recreational type boats do not have suitable deck fittings for towing or being towed.
- ✧ The boating public, in general, has limited knowledge and experience in towing.
- ✧ Recreational boaters sometimes fail to use good judgment due to inexperience and expediency.

In all towing operations, the primary objective is to ensure the personal safety of everyone involved. Your first goal is to save lives and avoid personal injury. The saving of the vessel is secondary and must never take precedence.

Preparation for Rough Weather

CAUTION

To prevent flooding, keep all hatches secured while underway.

Bertram has a long tradition of exceptional strength and seaworthiness. However, never lose sight of the fact that there is no vessel, regardless of its size and strength, that is completely immune to the dangers of heavy weather. It has been documented that supertankers have sustained wave damage to the bridge one hundred feet above the water. Therefore, when preparing for heavy weather, ensure that the cockpit hatches are secure and tightly dogged down to prevent flooding below decks.

Heavy Weather Checklist

- ✓ Close and secure all hatches and doors. Double-check that all cockpit hatches are secure.
- ✓ Occasionally operate the bilge pumps in the manual mode to assure that bilges are dry.
- ✓ Secure all loose gear. Stow all small items and lash down larger items.
- ✓ Have everyone don and properly adjust a PFD.
- ✓ Obtain the best fix possible on your current position and update the plot on your chart.
- ✓ Prepare your emergency gear, such as flashlights, first aid kit, sea anchor, and distress flares.
- ✓ Plot a course change to the nearest protected harbor or sheltered water.
- ✓ Stay current with local marine weather reports. If possible, assign one person to monitor the marine weather channels.
- ✓ Post at least one lookout whose sole responsibility is to watch for other vessels or possible dangers.
- ✓ Inform your crew and passengers of what you want them to do, or not to do. Advise them of your intentions.

Man Overboard

At the cry, "MAN OVERBOARD!" immediate action is of the utmost importance—every second counts, particularly at night or in heavy weather. It is extremely helpful to indicate which side he went over, such as: "MAN OVERBOARD—PORT!" This focuses the attention of those who did not see the accident and guides their actions.

Maneuvering for Pick-Up

Circumstances will dictate the best procedure as to how to approach the person in the water. One good procedure is to stop the boat a short distance up-wind from the victim and allow the boat to drift down. As the boat approaches the person in the water, shut down the engines and prepare to throw your type IV throwable device. Once the person is in range, throw the life ring, and pull him to the boat.

Use of Personal Flotation Devices

By Federal regulation, any vessel, powered or not, is required to have one (1) United States Coast Guard approved Personal Flotation Device (PFD) of suitable size and readily available for each person onboard. If the vessel is not used commercially, PFDs may be type I, II, or III. If the vessel is to be used commercially, and will be carrying six or more passengers for hire, the PFDs must be type I.

Bertram furnishes type II adult size (90 lbs) PFDs. This type of PFD is capable of turning its wearer to vertical or slightly backward position in the water. These PFDs are high visibility orange, comply with all of the USCG requirements for a type II device, and carry the United States Coast Guard approval label. Type II PFDs come in four sizes: adult (90 pounds plus), child large (50 to 90 pounds), child medium (30 to 50 pounds), and child small (less than 30 pounds).

This type of PFD is donned by placing it over the head with the collar behind the neck. The waist strap should then be connected and adjusted to prevent this device from riding up on the wearer. The technique for donning a PFD should be practiced by everyone, so that they know where to find them and how to properly don one, even in the dark or in the water.

The recommended technique for water entry while wearing a PFD is to wrap both arms as tightly as possible around the wearer's chest and under the chin. This protects the face and keeps the PFD from riding up. Always jump into the water feet first, with both feet and knees slightly bent. The head should be tucked down into the pocket made by the folded arms. As soon as a wearer is in the water, he should join others for mutual assistance and warmth.

Please keep in mind that Bertram furnishes only adult sized PFDs and that the USCG requires that everyone onboard have the correct size PFD. Please also keep in mind that if a PFD is stowed wet, mildew will hasten the deterioration of the PFD. If used, they should be rinsed with fresh water and dried out of the sunlight.

The USCG does not consider as "readily available" any PFD left in their original plastic wrappers, since persons under stress may be unable to remove them quickly.

In addition to the PFDs, Federal regulations require at least one (1) United States Coast Guard approved type IV throwable device. This device must be located where it is immediately available to those on deck.

Bertram supplies one type IV device. You should mount this device in a suitable location. We recommend about 60 feet of light line be attached to the device.

Visual Distress Signals

Federal regulations require all vessels, 16 feet or longer, carry onboard a minimum of three (3) USCG approved daylight distress signals and three (3) night distress signals. These signals may be flares, smoke generating devices, or battery powered automatic emergency signaling devices.

It is your responsibility to ensure that the signaling devices have not exceeded the expiration date marked on the approval label.

WARNING

DO NOT USE AUTOMOTIVE TYPE ROAD FLARES AS YOUR REQUIRED NIGHT DISTRESS SIGNALS. THE "SLAG" FROM AUTOMOTIVE TYPE FLARES CAN CAUSE BURNS AND MAY CAUSE A FIRE.

Bertram does not supply these signaling devices. A Coast Guard pamphlet entitled "Visual Distress Signals for Recreational Boats" is available from the Department of Transportation. A vessel over 12 meters in length falls within the category that requires it to carry both a bell and a whistle or horn. Bertram has equipped your boat with a suitable bell and horn.

Fire or Emergency Abandon Ship Plan

One situation for which you must be prepared is an uncontrollable fire, or other emergency at sea, requiring all hands leave the vessel. As an important part of your fire preparedness plan, the operator, along with the crew and regular guests, should develop and practice an **abandon ship drill**. At a minimum, this plan should include:

- Location of the life jackets and how to don them
- Location and operation of any other emergency flotation equipment, such as a life raft or throwable devices
- Speedy operation of the forward emergency egress deck hatch
- How to summon help quickly by use of the hailing/emergency channels for the onboard radios
- When and how flares or daylight visual distress signals are used
- Use of dye markers
- Use of an Emergency Position Indication Radio Beacon (EPIRB)
- Location of an abandon ship bag and the proper use of each item contained in the bag (The abandon ship bag or container must be one that will float if it is accidentally dropped overboard or must be carried while swimming.)

Overhead Rod Locker

WARNING

DO NOT MOUNT EQUIPMENT ON THE TOP OF THE ROD LOCKER DOOR. ADDITIONAL WEIGHT MAY CAUSE INADVERTENT OPENING OF THE DOOR. NEITHER THE HINGES, NOR THE LATCHES, ARE DESIGNED TO SUPPORT ADDITIONAL WEIGHT. THE DOOR MAY SWING DOWN UNEXPECTEDLY AND COULD CAUSE INJURY.

Carbon Monoxide (co) Gas

WARNING

DIESEL INTERNAL COMBUSTION ENGINES USE PETROFUELS AND EMIT CARBON MONOXIDE GAS, WHICH IS COLORLESS, ODORLESS, AND LETHAL IF INHALED IN SUFFICIENT QUANTITIES.

When at anchor, be sure to open hatches and vents to maintain fresh air even with the air conditioning operating and when operating the generator.

When secured to a dock and/or immediately alongside other vessels, or when rafted against other vessels, pay particular attention to the main engine and generator exhaust emissions from nearby vessels, since a lethal concentration of carbon monoxide could be drawn into your vessel from outside by your ventilation system.

Remember that carbon monoxide (CO) poisoning is one of recreational boating's most insidious hazards. CO poisoning first attacks the brain's judgment center, and its first symptoms (headache and nausea) are easily confused with seasickness. CO is lethal, and its effects are cumulative. As CO builds up in your body, your blood can carry less oxygen. This can take place over a long period of time and at relatively low concentrations.

Symptoms of Carbon Monoxide Poisoning:

- Throbbing in the temples
- Dizziness
- Ringing in the ears
- Watery, itchy eyes
- Headache
- Nausea
- Cherry pink or red skin color

You Should Immediately:

- Move everyone out on deck into fresh air
- Open all hatches
- Shutdown the engines and generator until you have located the source of the carbon monoxide
- If it's coming from your vessel, make all necessary repairs before getting underway.
- You should also be aware that it is quite possible for you to get the exhaust fumes of other vessels tied alongside. If the carbon monoxide is from a nearby vessel, move your boat or leave it.

GENERAL MAINTENANCE & CARE

Battery Care

WARNING

GASSES ESCAPING FROM A LEAD ACID BATTERY ARE A MIXTURE OF HYDROGEN AND OXYGEN. THIS MIXTURE WILL EXPLODE VIOLENTLY AND CAUSE SPRAYING OF BATTERY ACID IF EXPOSED TO A SPARK OR OPEN FLAME.

DO NOT DISTURB THE BATTERY CONNECTIONS WHILE THE BATTERIES ARE CHARGING.

WHEN WORKING ON THE BATTERIES, BE CERTAIN THAT:

THE ENGINES ARE NOT RUNNING.

- **ALL D.C. LOADS HAVE BEEN TURNED OFF.**
- **THE CONVERTERS HAVE BEEN TURNED OFF.**
- **YOU ARE NOT WEARING RINGS OR METALLIC WATCH BANDS.**
- **YOU USE EXTREME CAUTION TO AVOID HAVING WRENCHES OR OTHER TOOLS CONTACT THE TERMINALS**

IF BATTERY ACID IS SPLASHED IN THE EYES, THE FOLLOWING IMMEDIATE ACTION IS REQUIRED:

- **WASH OUT IMMEDIATELY AND CONTINUOUSLY WITH PLENTY OF COLD, FRESH WATER FOR AT LEAST TWENTY (20) MINUTES.**
- **IF COLD, FRESH WATER IS NOT AVAILABLE, USE MILK OR ANY WATER-BASED, POTABLE (DRINKING) LIQUID.**
- **SEE A DOCTOR AS SOON AS POSSIBLE.**

IF ACID IS SPLASHED ON OTHER PARTS OF THE BODY OR CLOTHING: --

- **REMOVE THE CLOTHING IMMEDIATELY.**
- **WASH THE AREA WITH PLENTY OF COLD WATER.**
- **THE ACID MAY BE NEUTRALIZED WITH A SOLUTION OF BAKING SODA OR HOUSEHOLD AMMONIA AND WATER.**

CAUTION

Do not overfill battery cells. Excessive liquid will cause acid to spill from the vents when the battery is charging and will cause corrosion at the terminals.

Never add acid to a battery.

The first choice for adding water to the battery electrolyte is distilled water. If distilled water is not available, a good grade of potable (drinking) water may be used if the water is free of minerals, particularly iron. Adding water to a cell will temporarily lower the specific gravity of the electrolyte solution in that cell. However, that does not mean that the cell has lost any of its charge.

Under proper operating conditions, your batteries will require only a slight amount of distilled water every few weeks. If excessive water is required, this is frequently a sign that the battery has been overcharged, and the engine alternators and converters should be checked. With age, the batteries will begin to consume more water and give the appearance of improper charging. This is usually an indication that the batteries may need to be replaced in the near future.

Diesel Fuel

WARNING

NEVER ADD COMMERCIALY MARKETED DIESELHOL OR GASOHOL TO DIESEL FUEL. THIS MIXTURE CREATES BOTH EXPLOSIVE AND FIRE HAZARDS.

Use only a high quality diesel fuel that meets the engine manufacturer's requirements. It is the responsibility of the owner to insure that only a high quality diesel fuel is used. Particular attention to fuel quality is necessary in some areas of the world. Ask your dealer to recommend a test-kit, additive, or filter, which will help avoid the problems associated with contaminated fuel, which can, if untreated, cause permanent damage to your engines or exhaust system.

Oil or Fuel Soaked Rags and Wipes

WARNING

OIL OR FUEL SOAKED RAGS AND WIPES MAY BE SUBJECT TO SPONTANEOUS COMBUSTION. DO NOT KEEP OILY RAGS IN THE ENGINE ROOM.

Electrical Repairs

WARNING

A.C. CIRCUITS CAN DELIVER A LETHAL SHOCK!

BEFORE OPENING AN ELECTRICAL DISTRIBUTION PANEL OR SERVICING ANY ELECTRICAL EQUIPMENT:

- ✧ **DISCONNECT THE SHORE POWER CORD.**
- ✧ **STOP THE GENERATOR.**
- ✧ **TURN OFF THE MAIN BATTERY DISCONNECT SWITCHES.**

CAUTION

Do not replace your vessel's circuit breakers or fuses with breakers or fuses of higher amperage than those installed by Bertram. Choose breakers and fuses for the spare circuits with ratings that match the load of the equipment, but does not exceed the current carrying capacity of the cables in each branch circuit.

Bertram recommends that a qualified marine electrician perform any electrical maintenance or addition of any electrical device. If repairs or modifications are performed incorrectly, there is a risk of an electrical fire.

Cockpit Hatch Dog Adjustment

The hatch dogs on the cockpit hatches require adjustment to eliminate seepage. To avoid over-compressing the gaskets, these dogs should not be over tightened. After the hatch dogs are adjusted, check for seepage as water is poured over the hatch.

Non-Fiberglass Plastics

Besides fiberglass reinforced plastic (FRP), better known as fiberglass, your Bertram has both acrylic and Acrylonitrile Butadiene Styrene (ABS) parts. These parts are lightweight and very strong. However, they are relatively soft, and improper cleaning can easily scratch their surfaces.

Among other uses, clear acrylic plastic is used for the flybridge spray shield and the protective weather covers for your instruments and electronics. Acrylics are much tougher than glass and are resistant to stains and sunlight. However, hard objects, grit, brushes, and abrasives easily scratch them. Solvents such as acetone, mineral spirits, and lacquer thinner also readily attack them.

To clean acrylic plastic, use a commercial cleaner such as "Novus" or "Brilliance", manufactured by "Kleen Master", or a mild detergent in warm water and a 100% natural cotton cloth.

ABS plastic can be cleaned with a commercial plastic cleaner such as "Armorall" or "Brilliance". Do not use solvents such as lacquer thinner, acetone, mineral spirits, or abrasive cleaners.

Fiberglass Care

The gelcoat on your Bertram is unquestionably the finest quality product on the market today and is manufactured by Cook Composites and Polymers. Their gelcoat, "Armorcote", will provide outstanding shine and durability for many years.

Polyester gelcoats are very resistant to water and other chemicals, but the number of overly harsh cleaners that are available on the market is alarming. Avoid any strong alkaline, such as trisodium phosphate or high acidic cleaners, as well as bleach and ammonia. These materials, left in contact with polyester, may attack or change the color. Any cleaner that is used should be in contact with the polyester the minimum amount of time required to do the job. All cleaners are meant to attack dirt and remove it. The longer they remain in contact, the more they attack the dirt and finish. It is best to use mild detergents such as hand dishwashing soap, which will work for the majority of stains and dirt accumulations. Because "Armorcote" requires special chemicals to produce a perfect repair, it is suggested that any repair be left to a professional fiberglass technician.

Crevice Corrosion

Some metals develop a film that protects against corrosion. In cracks and crevices, not unlike between the propeller shaft and the strut bearings, this film is often broken down because of a lack of oxygen. Stainless steel is very susceptible to crevice corrosion.

If your vessel is not frequently used, or is in wet storage, it is important to rotate the propeller shafts approximately once a week to prevent crevice corrosion.

Galvanic Corrosion

One of nature's phenomena is the fact that two different connected metals immersed in an electrolyte (electricity-carrying liquid) develop electrical voltage and current. The metal that is most active electrically will deteriorate while protecting the metal that is less active. Therefore, Bertram installs a sacrificial zinc (anode) to the transom. The zinc is connected to all of the underwater and some internal fittings via the bonding system. It is important to inspect the zinc at least once a month. When the zinc has deteriorated to about one quarter of its original size, it should be replaced.

A list has been included that indicates which metal or alloy is more active. This list is called the nobility scale. Each metal is more active than the metal listed beneath it. Before replacing or adding any hardware to your vessel, you should refer to this list.

Least Noble: *Magnesium*
Galvanized iron
Alloy steel
Active stainless steel
Tin
Manganese bronze
Naval brass
Yellow brass
Admiralty brass
Copper
Silicone bronze
Tin bronze
Copper – nickel (70/30 alloy)
Passive stainless steel
Monel
Titanium
Silver
Platinum
Most Noble: *Gold*

Stray Current Corrosion

Stray current corrosion is similar to galvanic corrosion in that the more active metal will deteriorate. However, this type of corrosion is caused by an outside source rather than spontaneously in nature. Your vessel's D.C. or A.C. system, the dock's A.C. system, or other boats on the dock could be a source of stray current corrosion. Generally, stray current corrosion is much more destructive than galvanic corrosion. For this reason, your vessel is fitted with a **galvanic isolator** that electrically separates the green (ground) wire in the shore power system from the ground wire in the A.C. system. Zinc loss and stray currents are eliminated. The galvanic isolator is a passive device and requires no maintenance.

Stainless Steel

As the name implies, stainless steel will stain less than some other metals. However, it is not impervious to deterioration. During the manufacturing process, it is impossible to prevent microscope scratches on stainless steel fittings and fasteners.

Normally, stainless steel protects itself from corrosion by a naturally generated oxidized surface. This condition is called its passive state. When the film is scratched and unable to replace itself, the stainless steel will become more active and will leach out rust from the iron in its alloy makeup. A lack of oxygen in the scratches on the surface brings the stainless to an active state. The use of a passivator such as "Ospho" will return stainless to its passive state. After treating the part with a passivator, the use of a good polish and wax will eliminate the rust stains.

Aluminum Railings

The aluminum railings on your Bertram are made from the finest material available. However, like stainless steel, they require preventive maintenance. By thoroughly washing them with plenty of soap and water, they will remain undamaged by the marine environment for many years. A product developed by Rupp, called "Aluma Guard", provides an excellent protective shield.

MISCELLANEOUS SYSTEMS & ACCESSORIES

Air Conditioning System

The components in your air conditioning system are designed and built for saltwater use. Your system operates with seawater cooled, reverse-cycle condensers and either cools or heats as required for your comfort.

The condensate from the forward cooling units drains into the gray water sump tank and is automatically pumped overboard. **Important:** do not turn off the gray water pump circuit breaker. If the breaker is turned off, condensate may overflow the gray water tank. The salon cooling unit drains overboard via the common drain. The machinery room cooling units have a dedicated sump pump to discharge the condensate water.

All air conditioning units are 240-VAC and powered through the circuit breakers in the salon A.C. distribution panel.

Please see the documentation provided in the owner's information case for detailed information on your system.

If your vessel is equipped with a tempered water system, it is **not protected against freezing weather conditions**. To prevent damage to your tempered water air conditioning system, it must be "winterized" by a qualified air conditioning professional.

On some models, the air conditioning condensate drains into the shower sump pump and is pumped overboard. Therefore, it is imperative that the shower pump breaker be left **ON** at all times.

NOTE

Some models have a separate circuit breaker for the A/C cooling water pump. Whenever the A/C main circuit breakers are on, the water pump breaker must also be on.

It is very important that you read and understand the air conditioning operation's manual before you attempt to operate your air conditioning. Please read the air conditioning manufacturer's manual, provided with your owner's information.

Before starting the air conditioning system, make sure that the air conditioning seawater seacock is open. After starting the unit(s), confirm that seawater discharge is flowing from the through hull outlet.

If your boat has been hauled from the water, seawater may have drained from the system. When the boat is returned to the water, air may need to be bled from the seawater strainer before the A/C pump is operated.

Central Vacuum System

WARNING

TO AVOID ELECTRICAL SHOCK, DO NOT USE ON WET SURFACES OR VACUUM WATER OR DAMP MATERIALS.

FIRE DANGER:

DO NOT VACUUM HOT ASHES, CIGARETTE BUTTS, OR FLAMMABLE POWDERS.

DO NOT OPERATE NEAR FLAMMABLE GASSES OR LIQUIDS.

DO NOT CHANGE THE BAG WHEN THE HOSE IS CONNECTED AND THE VACUUM IS OPERATING.

Your vacuum system's accessories will allow you to reach all the living areas. However, the system is not a wet vacuum system and is not designed or intended for use in the bilges or engine room.

The vacuum is powered by 120-VAC. It is automatically switched on when the hose is plugged into the vacuum receptacle, and is automatically switched off when the hose is removed. Replacement collection bags are available from:

Wal-Vac, Inc.
318 Mart Street SW
Grand Rapids, Michigan 49508

Swim Platform

WARNING

THE PROPELLERS MAY REVOLVE VERY SLOWLY, EVEN IF THE TRANSMISSION IS IN NEUTRAL.

CARBON MONOXIDE POISONING DANGER:

DO NOT ALLOW ANYONE TO OCCUPY THE SWIM PLATFORM WHILE THE ENGINES OR GENERATOR ARE OPERATING.

OWNER'S RESPONSIBILITIES

We at Bertram Yacht, Inc. are proud of the vessels we manufacture. We warrant them in accordance with the terms of the Limited Warranty applicable to the original purchaser of our vessels. Keeping the vessel in good order, however, is the owner's responsibility, and requires a great deal of consideration. It is part of the nature of vessels, marine engines, and marine equipment that they require much attention and frequent, regular, and proper maintenance in order to stay in a condition where performance is maximized and in which they do not degrade. This is the owner's responsibility.

INDEX

50 ABANDON SHIP DRILL		
24 A.C. DISTRIBUTION PANEL		
23 A.C. ELECTRICAL SYSTEM	C/N	
28 A.C. SHORE POWER	W/C	
41 AFT CONTROL STATION	C	
31 AFTER FIRE SYSTEM DISCHARGE	W	
57 AIR CONDITIONING	N	
57 ALUMINUM RAILINGS		
38 ATMOSPHERIC CONDITIONS		
52 BATTERY CARE	W/C	
21 BATTERY DISCONNECT SWITCHES	C	
21 BATTERY PARALLEL SYSTEM	N	
11 BILGE PUMPS	C	
19 CABLEMASTER	W	
51 CARBON MONOXIDE	W	
58 CENTRAL VACUUM SYSTEM	W	
27 CIRCUIT PROTECTION	C	
33 CLASSES OF FIRES	W	
43 COMPASS	C	
28 CONVERTERS	N	
55 CREVICE CORROSION		
42 CRUISING SPEED MANEUVERING		
20 D.C. ELECTRICAL SYSTEM		
20 D.C. EQUIPMENT PROTECTION	C	
20 D.C. POWER DISTRIBUTION		
38 D.C. VOLTAGE		
46 DAMAGED UNDERWATER GEAR	C	
44 DEVIATION		
53 DIESEL FUEL	W	
16 DOCKSIDE WATER	C	
2 DOCUMENTATION		
44 DRAFT		
54 ELECTRICAL REPAIRS	W/C	
12 EMERGENCY BILGE PUMP	W	
41 ENGINE CONTROL	C	
36 ENGINE COOLANT TEMPERATURE	W	
36 ENGINE INSTRUMENTS	N	
37 ENGINE LUBE OIL PRESSURE		
8 ENGINE/SHAFT ALIGNMENT		
36 EXHAUST SYSTEM	C	
56 FIBERGLASS CARE		
32 FIRE FIGHTING PLAN		
29 FIRE MONITOR SYSTEM	N	
30 FIXED FIRE SYSTEM	W	
1 FOREWORD		
15 FRESH WATER PUMP		
14 FRESH WATER SYSTEM		
8 FUEL REMAINING IN TANK		
7 FUEL SYSTEM	C/N	
56 GALVANIC CORROSION		
28 GALVANIC ISOLATOR		
37 GEAR OIL PRESSURE		
37 GEAR OIL TEMPERATURE		
52 GENERAL MAINTENANCE	C	
6 GENERATOR		
27 GFCI		
16 GRAY WATER SYSTEM		N
17 GRAY WATER TANK MONITOR		
45 GROUNDING		C
54 HATCH DOGS		
46 HEAVY WEATHER CHECKLIST		
46 HEIGHT ABOVE WATERLINE		
34 HULL EFFICIENCY		
28 INTERNATIONAL SHORE POWER		C
17 LIVE BAIT WELL		
5,35 MAIN ENGINES & TRANSMISSIONS		
48 MAN OVERBOARD		
34 MARINE GROWTH		
7 MECHANICAL SYSTEMS		W/C
23 NAVIGATION LIGHTS		N
56 NON-FIBERGLASS PARTS		
11 OIL DISCHARGE WARNING		W
53 OILY RAGS AND WIPES		W
50 OVERHEAD ROD LOCKER		W
59 OWNER'S RESPONSIBILITIES		
49 PERSONAL FLOTATION DEVICES		
10 PROPELLER HAZARD		W
9 PROPELLER INSTALLATION		
10 PROPELLER SHAFT REPLACEMENT		
10 PROPELLER SHAFT SEALS		
5 PROPELLER SHAFTS		
5 PROPELLERS		N
7 PROPULSION SYSTEM CARE		
42 PRUDENT SPEED		
6 PUMPS		
11 RUDDER ALIGNMENT		
11 RUDDER SEALS		
15 SHOWERS		
42 SLOW SPEED MANEUVERING		
57 STAINLESS STEEL		
25 STARTING THE GENERATOR		C
39 STEERING		
56 STRAY CURRENT CORROSION		
59 SWIM PLATFORM		W
38 TACHOMETER		N
5 TECHNICAL DATA		
29 TELEPHONE & CATV		
13 TOILET (HEAD) SYSTEM		C/N
47 TOWING		W
40 TRIM TASS		W/N
42 UNDERWAY		W
3 USCG REGULATIONS		N
43 VARIATION		
22 VENTILATION SYSTEMS		
4 VESSEL INFORMATION		
49 VISUAL DISTRESS SIGNALS		W
2 WARNINGS, CAUTIONS, & NOTES		
17 WASHDOWN SYSTEM		C/N
15 WATER HEATER		W
35 WATER IN THE BILGE		
18 WINDLASS		W

W = WARNING
C = CAUTION
N = NOTE



This glossary is included for your reference.

ABAFT

Closer to the back of the vessel. The transom is said to be abaft of the cabin.

ABEAM

Along side; directly off one side of the vessel

ABOVE

Higher in the vessel. To go up to the next deck in a vessel is to go above.

ADAPTER

A coupling or device that permits fitting of different sizes to be joined

AFT

Toward the stern

AFTER END

The stern

AFTER PEAK

The compartment furthest aft.

AFTERMOST

Nearest the stern

AHEAD

Forward; when a vessel is moving ahead, is moving forward

ALOFT

Above the deck; if you are going up a mast or into the rigging, you are going aloft

AMIDSHIP OR AMIDSHIPS

Midway between the bow and the stern, or midway between the port and starboard sides

AMPERE

the standard unit used to measure the strength of an electrical current. abbreviated "Amp" or "A"

ANCHOR

A mechanical device used to hold a vessel in a desired position

ANCHOR LINE

Also called a rode. The line connecting the vessel to the anchor. It may be all rope, all chain, or a combination of rope and chain

AGROUND

Stuck fast to the bottom

ANCHOR BALL

A black, circular, day signal hoisted to show that the vessel is anchored. It is replaced by a light at dusk

ASTERN

Toward the stern; abaft

ATHWARTSHIPS

Along a line running perpendicular to the keel

BATTEN DOWN

To secure for rough weather

BEAM

1. The widest distance across a vessel from the outside skin on one side to the outside skin on the other.
2. A transverse structural member that stiffens and supports a portion of the deck

BEAM WIND

A wind blowing toward the side of the vessel, approximately perpendicular to the longitudinal axis of the vessel

BELAY

1. To make fast or secure, as to belay a line.
2. To cancel or stop an action, as belay the last order

BELOW

Lower in a vessel; to go below is to go to a lower deck or go into the cabin

BEND

A type of knot

BILGE

the lowest interior area of the hull, used to collect water that seeps or leaks in

BINNACLE

the stand of support for a magnetic compass

BITTER END

The last part of a rope or chain

BOLLARD

A single post on a dock used to secure a vessel's lines

BONDING

1. Electrically connecting exposed, metallic, non-current-carrying parts to the main engine block.
2. Cementing together with an adhesive

BOW

The front end of a vessel

BOTTOM

The portion of the hull below the bilge

BREAK OUT

Take out of storage and prepare for use

BRIDGE

The main operational control center of a vessel

BROACH

To be thrown broadside into the trough of waves and effectively out of control

BULKHEAD

An interior wall or partition

BULWARK

A portion of the hull extending above the deck

CAMBER

Transverse curvature of the deck

CAPSTAN

BILGE PUMP

A pump intended to remove spray, rainwater from the bilge

CENTERLINE

The fore and aft line at the middle of the vessel

CHAIN LOCKER

The compartment where the anchor line is stored

CHINE

The line where the bottom of the vessel meets the side. If this turn is rounded, it is a soft chine. If the turn is squared off, it is a hard chine.

CHOCK

1. A fitting or hole in a railing of deck through which a mooring or anchor rode runs.
2. A wedge used to secure something in place

CIRCUIT BREAKER

A circuit protection device used to interrupt an electrical circuit when the current flow exceeds a preset level. Your Bertram is equipped with magnetic, not thermal, circuit breakers

CLEAT

A double ended deck fitting used to secure a line

COAMING

A raised lip around a hatch, intended to keep water from coming through the hatchway

COCKPIT

An exposed deck area that is substantially lower than the vessel's adjacent weather deck

COMPANIONWAY

The steps of ladder leading from a deck

COVERING BOARD

The top surface of the sides and transom on a vessel

COWL

A bell-shaped air funnel or scoop projecting above the deck or deckhouse of a vessel, used

A machine, similar to a winch but with a vertical axis, that moves a cylindrical device called gypsy on a shaft for hauling up the anchor

CRADLE

A frame or support for moving the vessel when it is out of the water

DEAD AHEAD

Directly in front of the vessel

DEAD RECKONING

A navigational technique that measures from a last known to the present estimated position based on time, speed, and direction. Abbreviated DR.

DECK

The floor of a vessel

DINGHY

A small boat used in moving between the vessel and shore

DISPLACEMENT

The weight of the water displaced by the vessel's hull

DOCK

A pier or wharf to which vessels are moored

DOCUMENTED YACHT

a vessel of five or more net tons that is owned by a United States citizen, is used exclusively for pleasure, and has a valid marine documentation issued by the US Coast Guard. A documented yacht does not show state registration numbers

DOG

A small metal fitting (clamp) used to secure a port, hatch, or door

DOG DOWN

To tighten the dogs on a port, hatch, or door

DRAFT

1. The depth of a vessel from the actual water line to the bottom of the vessel's lowest point.
2. The depth of the water necessary to float the

for ventilation

DRIFT

The speed of current measured in knots

DUNNAGE

Cargo associated waste

DYE MARKER

A brightly colored chemical that spreads when released in the water to attract attention

EVAPORATOR

The part of an air-conditioning system where the liquid refrigerant is evaporated to absorb heat and produce cooling

EVEN KEEL

To be floating evenly without listing

FATHOM

Six feet

FENDER

A device placed to absorb the impact of contact between vessels or between a vessel and the dock

FIBERGLASS

Fiber Reinforced Plastic FRP

FLAT

A small, partial deck, built to support a piece of or machinery

FLEMISH

To coil down a line on deck in a flat, circular, concentric arrangement

FLOTSAM

Floating wreckage or trash

FLYBRIDGE (FLYING BRIDGE)

A steering and speed control station located above the main cabin or salon

vessel.

FORE-AND-AFT

In line with the longitudinal centerline of the vessel

FOREFOOT

The forward part of the vessel's keel that curves upward to meet the stem

FORWARD

Toward the bow

FRAME

A built up rib that supports the deck and hull and gives the vessel transverse strength

FREEBOARD

The height of a vessel's deck above the waterline

GALLEY

The food preparation area

GALVANIC CORROSION

Corrosion that results from the difference in electrical potential between dissimilar metals immersed in a conductive solution (such as seawater). If the metals touch or are otherwise electrically connected, the difference in potential produces an electron flow between them. This results in a gradual destruction of the less corrosion resistant metal

GASKET

A strip of sealing material, usually rubber or rubber-like material, set along the edge of a water/gas tight door, port, or hatch

GELCOAT

The thin finish layer of pigmented plastic covering a fiberglass vessel

GRAYWATER

Drainage from a shower, laundry, bath and washbasin

GROUND (ELECTRICAL)

FOLLOWING SEA

Waves moving in the same direction as the vessel

GROUND SPEED

A vessel's speed over the sea bottom

GROUND TACKLE

A general term for the anchor, anchor lines, and other fittings used to secure the vessel at anchor

GUNWALE

1. The line where the upper deck and the hull meet
2. The upper edge of vessel's side

HALYARD

A light line used to hoist a flag or pennant

HATCH

An opening in the deck or sole that forms an entrance to a compartment

HEAD

A shipboard toilet or lavatory area which may or may not include a shower

HEADING

The direction that a vessel is pointed with reference to true, magnetic, or compass North

HEADWAY

The forward motion of a vessel through the water

HEAVY WEATHER

High seas and high winds

HELM

the apparatus by which the vessel is steered

HELMSMAN

steersman; one who is at the helm steering station

HITCH

A type of knot

The electrical potential of the earth's surface which is zero

INBOARD

1. From either side of a vessel to the fore-and-aft centerline
2. The dock side of a moored vessel

INLAND RULES

Nautical Rules-of-the-Road that apply in U.S. lakes, rivers, and coastal waters

INTERNATIONAL RULES

Nautical Rules-of-the-Road that apply by international agreement to the high seas

JETSAM

Refuse that sinks when thrown over-board

KEDGE

An anchor set out from a grounded vessel, usually astern, to keep the vessel from being driven further aground or to assist in refloating her

KEEL

The main centerline structural member running fore and aft along the bottom of the vessel

KNOT

1. A maritime unit of speed equal to one nautical mile (6,080 feet) per hour, as compared to a statute mile (5,280 feet)
2. A collective term for hitches and bends

LADDER

shipborne steps or stairs

LATITUDE

The angular distance on the earth's surface north or south of the equator, measured in degrees, minutes, and seconds

LAZARETTE

A storage compartment cut into the deck at the stern

HULL

The body of a vessel including the shell framing, decks, bulkheads stations, keel, and floors

LEE

The direction away from that of the wind

LEEWARD

Away from the wind; downwind

LENGTH AT WATER LINE (LWL)

The length a vessel measured at the water line from the bow to the stern. This dimension changes depending on how high or low the vessel is riding in the water

LENGTH OVER ALL (LOA)

A vessel's straight line length from the bow to the stern. This dimension does not change regardless of how a vessel rides in the water

LIMBER HOLE

Drainage hole for bilge water along the keel and stringers

LIST

Incline to port or starboard

LONGITUDINAL

Lengthwise; running along the length of the vessel

LUBBER LINE

A mark or line on the compass parallel to the keel and indication forward

MAIN DECK

The principal and highest deck of the hull

MIDSHIP

1. Aligned with the longitudinal axis of the vessel, as "rudder amidship"
2. At the center of the vessel

MOOR**LEADLINE**

A weighted line used to take depth measurements

MOORING LINE

The line with which a vessel is secured to a mooring

NAVIGATION LIGHTS

A combination of red, green, and white lights which must be shown by all vessels between dusk and dawn to show course, size, and position. They are required unless moored or at anchor in a recognized anchorage

OVERHEAD

A vessel's ceiling

OUTBOARD

1. From the fore and aft centerline of a vessel toward either side
2. The sea-ward side of a moored vessel

OVERBOARD

Over the side of the vessel

PASSAGEWAY

A corridor or hallway

PILASTER

Structural support column which is an extension of the port and starboard aft cabin sides and which supports the hardtop and flybridge

PITCH

1. The vertical motion of a vessel's bow in a seaway
2. The axial advance of a propeller during one complete revolution, measured in inches

PITCHPOLING

Tipping end over end from running down the face of a wave and burying the bow; somersaulting

PLANNING HULL

A hull designed to ride on top of the water at cruise speed. At slow speeds, a planning hull will displace

To anchor or secure a vessel with lines to shore, dock, or a buoy (mooring)

MOORING BIT

Standards placed in pairs to which mooring lines are made fast

PORT

The left side of the vessel

PORT BEAM

The left center of a vessel

PORT BOW

The forward left area of the vessel

PORT QUARTER

The left rear area of a vessel

POUNding

The action of waves as they repeatedly raise a grounded vessel and drop it against the seabed

PROPELLER

The screw-like device that drives the vessel through the water

PROPELLER ACTION

The force exerted by the propeller. The propeller creates a suction screw current and a discharge screw current

PULPIT

An extension of the bow at deck level

RISER

An angular pipe connected to the engine's exhaust system to prevent water from entering the engine from the exhaust

ROPE LOCKER

A space or compartment where the anchor line is stowed

RUDDER

A movable, vertical fin extending into the water at the stern of the vessel, used for steering

water the same as displacement hull. At higher speeds, a planning hull advances over the bow wave and rides on top of the water, reducing drag

SEACOCK

A positive action shut-off valve connected directly to a hull seawater intake or discharge pipe

SECURE

To fasten down

SHAFT

The cylindrical member that connects the engine/transmission to the propeller

SHAFT LOG

A reinforced structural member at the hull bottom where the propeller shaft penetrates the hull

SHEER

The top of the hull's curvature at the deck line

SHEER STRAKE

The upper edge of the hull, just below the deck

SHOAL

An area of shallow water

SOLE

A term for a deck, as in salon sole, or cockpit sole

STANCHION

A vertical structural support

STARBOARD

The right side of the vessel

STARBOARD BEAM

STARBOARD BOW

STARBOARD QUARTER

See port side descriptions above

STEERAGEWAY

The lowest speed at which a vessel can maneuver

SALON

The main social cabin on a vessel

SCUPPER

A drain from the edge of the deck, discharging overboard

STRAINER

A coarse filter used to keep objects out of a hull bottom intake

STRINGER

A fore and aft continuous member used to give a vessel longitudinal strength

STRUT

A propeller shaft support that hangs below the hull

SUMP

A well into which water drains, such as a shower sump

SUMP PUMP

A pump intended to remove water from a sump

SUPERSTRUCTURE

structures extending above the weather deck

TIDE

The alternate rise and fall of the surface of oceans, seas and bays and rivers connecting them, caused by the attraction of the sun and moon. During its rise, tide is called flood tide, and during its fall it's called, ebb tide

TOPSIDE

Above decks. To go up to the top deck is to go topside

TOXIC

Poisonous

TRANSOM

A wide, flattened, or slightly rounded curved stern

TRANSVERSE**STEM**

The extreme leading edge of a vessel's hull

STERN

The back of a vessel is the stern

WATCH

A duty period at sea, normally 4 hours.

First watch	2000 to 2400 hours
Midwatch	0000 to 0400 hours
Morning watch	0400 to 0800 hours
Forenoon watch	0800 to 1200 hours
Afternoon watch	1200 to 1600 hours
First dog watch	1600 to 1800 hours
Second dog watch	1800 to 2000 hours

WATER LINE

the line of the water's surface on the hull when the vessel is afloat

WATER TIGHT

Sealed to prevent passage of water

WEATHER DECK

A deck with no overhead protection

WEB FRAME

A frame with a deep web, usually a main structural member

WINDLASS

A machine used to hoist the anchor

Across the vessel; ATHWARTSHIPS

TRIM

A term used to describe the way a vessel rides in the water. A change in trim is defined as a change in the difference between the forward and aft drafts. If a vessel is trimmed with the stern lower it is trimmed by the stern

BERTRAM 450 BILGE PUMP SYSTEM - U.S. BOATS

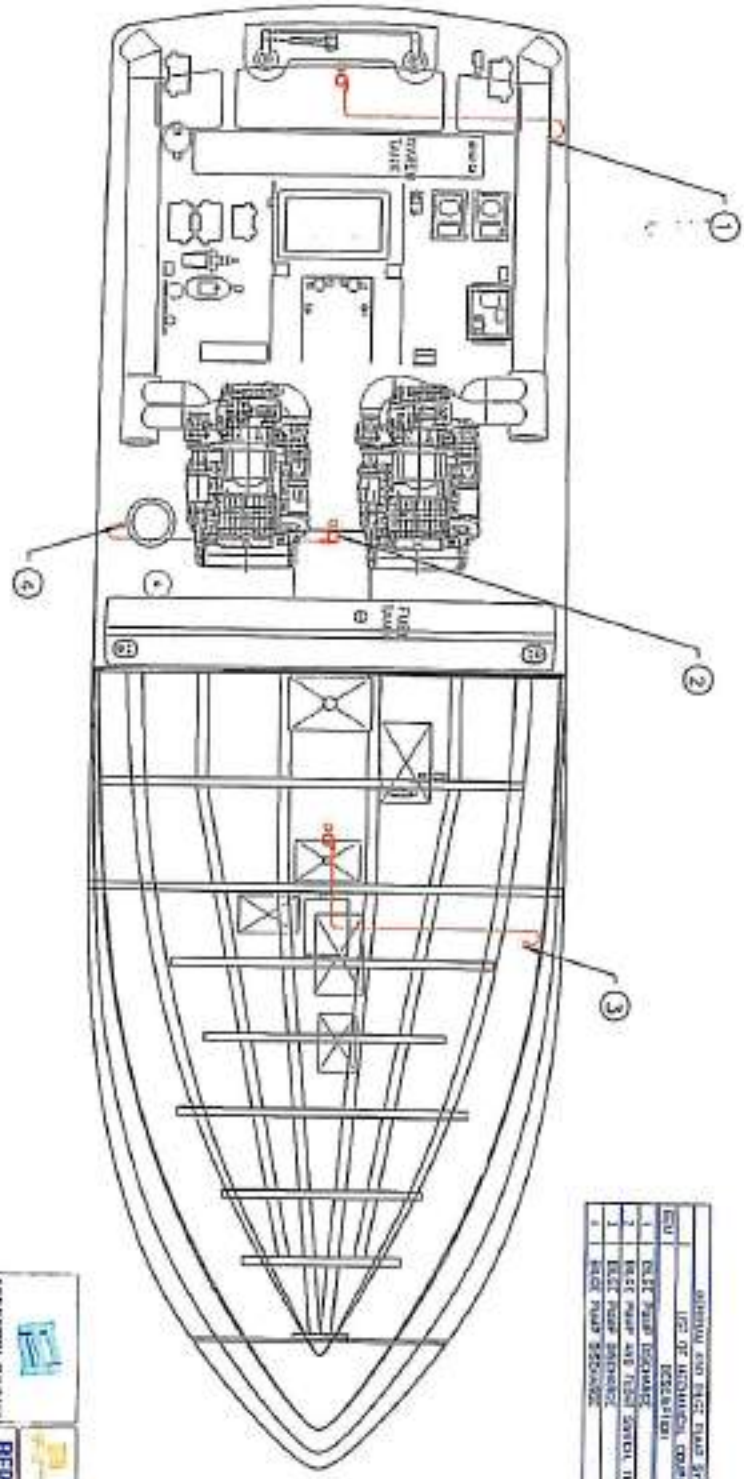

BILGE PUMP SYSTEM - U.S.		U.S. BOATS	
NO.	DESCRIPTION	QTY.	REMARKS
1	BILGE PUMP MOTOR	1	
2	BILGE PUMP AND FUEL TANK	1	
3	BILGE PUMP DISCHARGE	1	
4	BILGE PUMP SUCTION	1	

BERTRAM ENGINEERING DEPT.	
BILGE PUMP SYSTEM U.S. BOATS	
8450	1/2" NPT 1/2" NPT 1/2" NPT
© 1984 BERTRAM ENGINEERING DEPT.	

**BERTRAM 450
ESCAPE HATCHES &
FIRE EXTINGUISHER LOCATIONS**

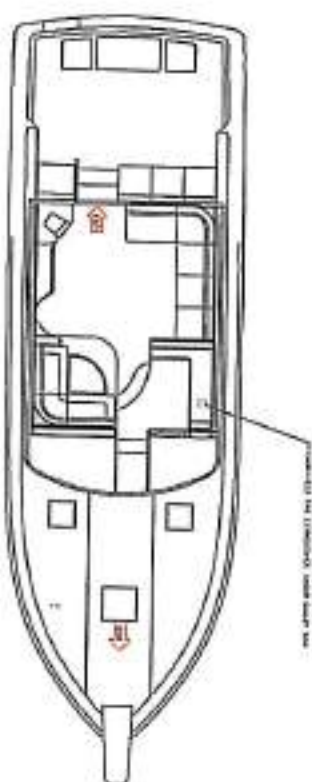
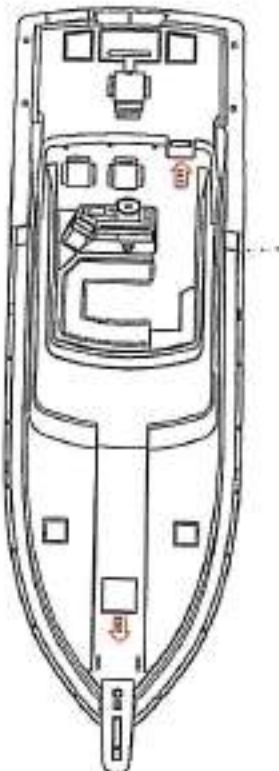

			
FEATURES GROUP			
ESCAPE HATCHES & FIRE EXT. LOCATIONS			
MODEL: B450			
PRICE: \$11,995			
YEAR: 2014			
STATUS: IN STOCK			
CONTACT: 800-441-1111			
WWW.BERTRAMBOATS.COM			

BERTRAM 450 EXHAUST SYSTEM

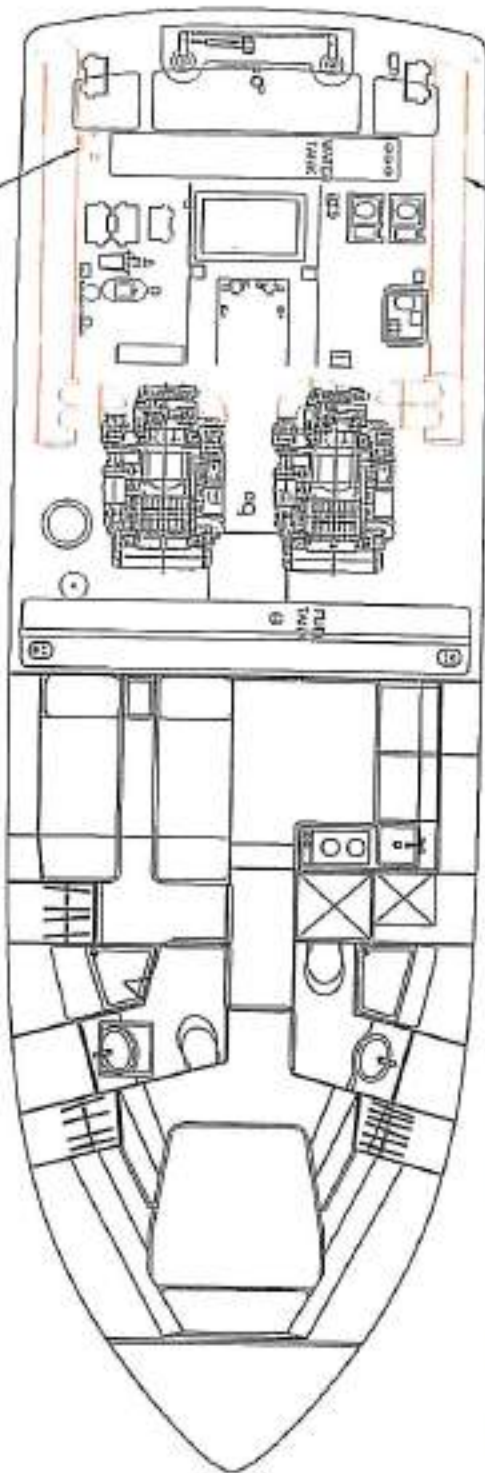

ITEM	DESCRIPTION	QTY	NO. #
1	EXHAUST SYSTEM	1	241111-10
2	EXHAUST SYSTEM	1	241111-10

FELATTE GROUP

BERTRAM ENGINEERING DEPT.

EXHAUST SYSTEM

B450

REV. 1.0

DATE: 11/11/11

BY: [Signature]

NO. 1

NO. 2

NO. 3

NO. 4

NO. 5

NO. 6

NO. 7

NO. 8

NO. 9

NO. 10

NO. 11

NO. 12

NO. 13

NO. 14

NO. 15

NO. 16

NO. 17

NO. 18

NO. 19

NO. 20

NO. 21

NO. 22

NO. 23

NO. 24

NO. 25

NO. 26

NO. 27

NO. 28

NO. 29

NO. 30

NO. 31

NO. 32

NO. 33

NO. 34

NO. 35

NO. 36

NO. 37

NO. 38

NO. 39

NO. 40

NO. 41

NO. 42

NO. 43

NO. 44

NO. 45

NO. 46

NO. 47

NO. 48

NO. 49

NO. 50

NO. 51

NO. 52

NO. 53

NO. 54

NO. 55

NO. 56

NO. 57

NO. 58

NO. 59

NO. 60

NO. 61

NO. 62

NO. 63

NO. 64

NO. 65

NO. 66

NO. 67

NO. 68

NO. 69

NO. 70

NO. 71

NO. 72

NO. 73

NO. 74

NO. 75

NO. 76

NO. 77

NO. 78

NO. 79

NO. 80

NO. 81

NO. 82

NO. 83

NO. 84

NO. 85

NO. 86

NO. 87

NO. 88

NO. 89

NO. 90

NO. 91

NO. 92

NO. 93

NO. 94

NO. 95

NO. 96

NO. 97

NO. 98

NO. 99

NO. 100

BERTRAM 450 FRESH WATER SYSTEM

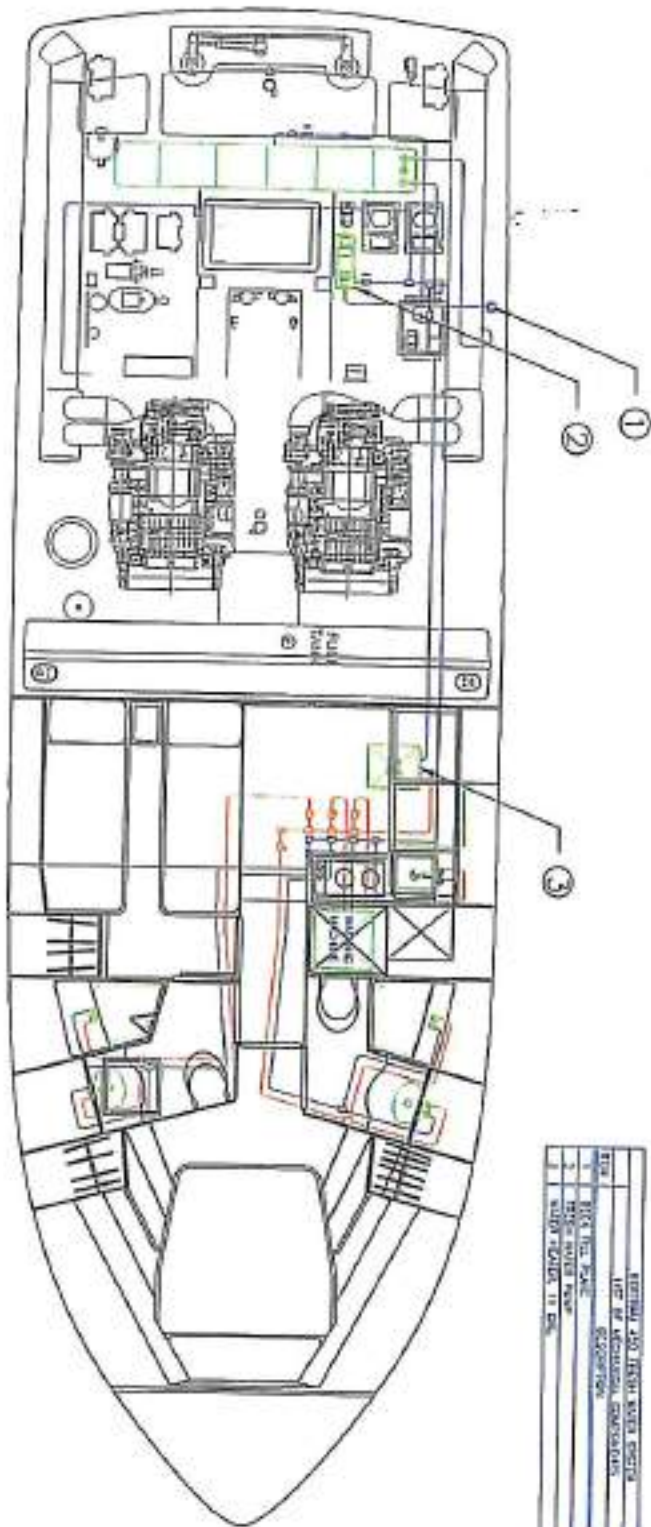

BERTRAM 450 FRESH WATER SYSTEM			
UPPER DECK COMPONENTS			
1	WATER PUMP	100 G.P.H.	100 G.P.H.
2	WATER TANK	100 G.P.H.	100 G.P.H.
3	WATER TANK	100 G.P.H.	100 G.P.H.

		BERTRAM ENGINEERING DEPT 1000 W. 10th St. Ft. Lauderdale, FL 33304 (954) 575-1111	
GENERAL INQUIRY			
FRESH WATER SYSTEM			
Model:	B450	Year:	_____
Serial No.:	_____	Engine:	_____
CONTACT: Mr. Bill Smith, Sales Representative, (954) 575-1111, ext. 1111			

BERTRAM 450 FUEL SYSTEM

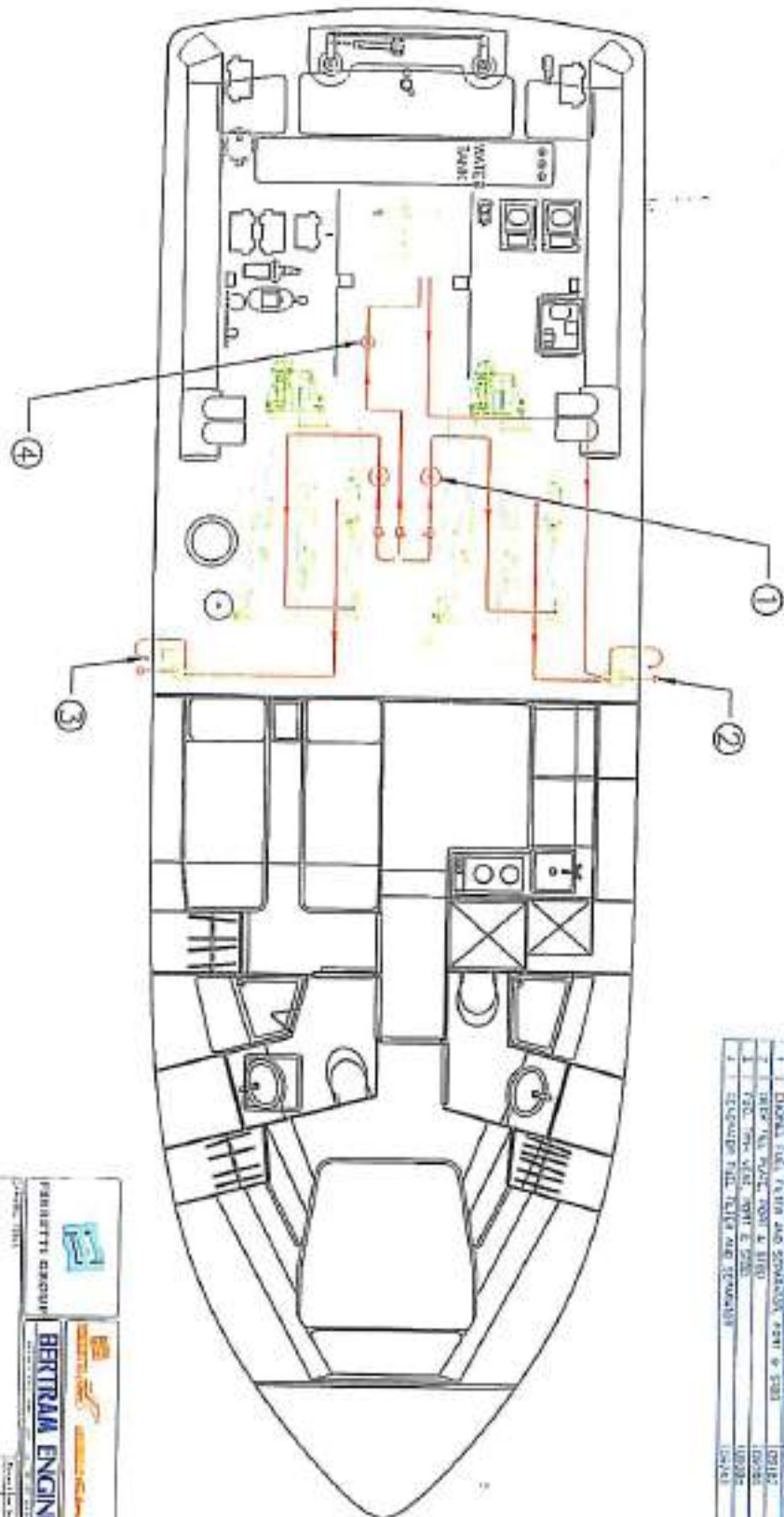

BERTRAM 450 FUEL SYSTEM			
ITEM	DESCRIPTION	QTY	REMARKS
1	DIESEL FUEL TANK AND SUPPLY LINE	1	100L
2	FUEL PUMP	1	100W
3	FUEL FILTER	2	100W
4	FUEL LINE	1	100W

FABRILETTI GROUP

BERTRAM ENGINEERING DEPT.

FUEL SYSTEM

B450

REVISION: 01

DATE: 01/01/2010

BY: [Signature]

APPROVED: [Signature]

BERTRAM 450 GENERATOR COOLING SYSTEM

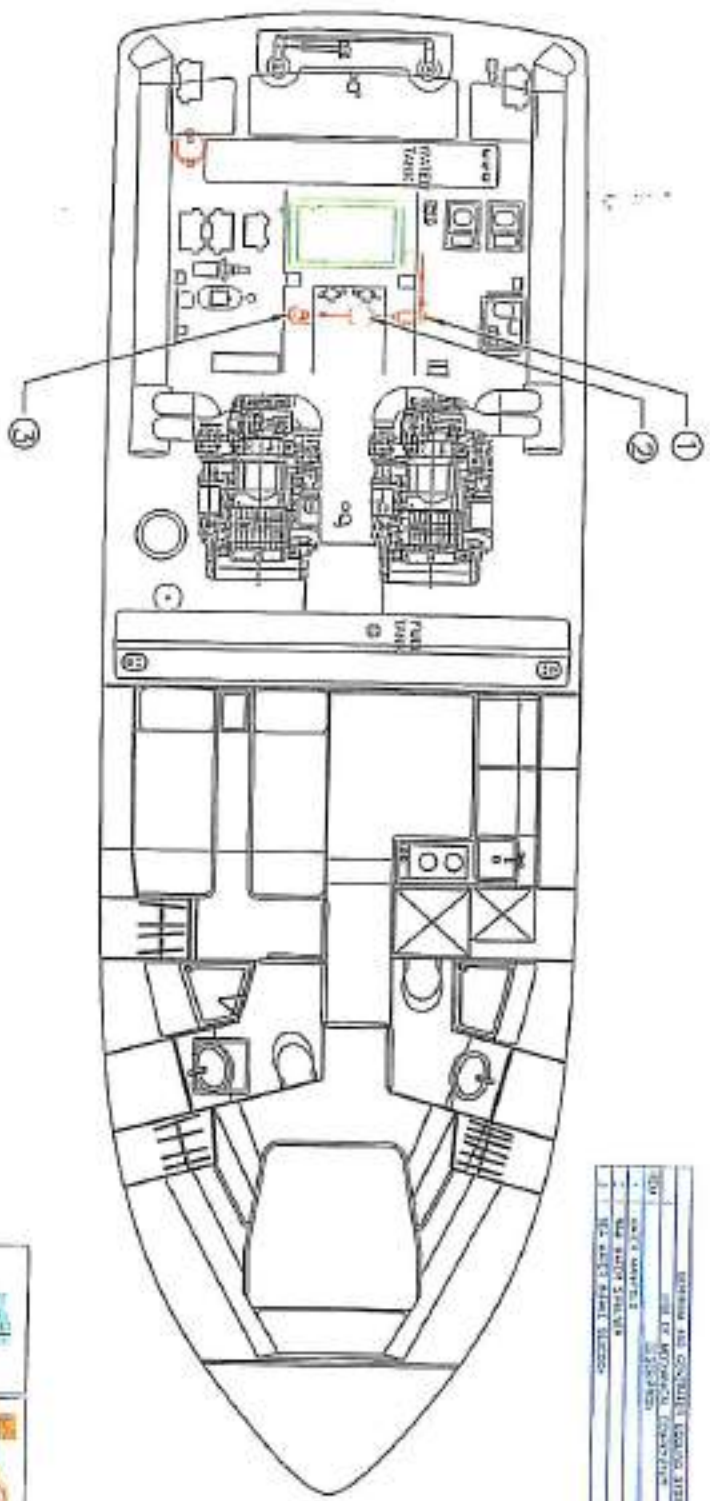

BERTRAM AIR CONDITIONING SYSTEM	
1	REF. TO MOTORWAY CONNECTION
2	REF. TO MOTORWAY CONNECTION
3	REF. TO MOTORWAY CONNECTION
4	REF. TO MOTORWAY CONNECTION
5	REF. TO MOTORWAY CONNECTION
6	REF. TO MOTORWAY CONNECTION
7	REF. TO MOTORWAY CONNECTION
8	REF. TO MOTORWAY CONNECTION
9	REF. TO MOTORWAY CONNECTION
10	REF. TO MOTORWAY CONNECTION
11	REF. TO MOTORWAY CONNECTION
12	REF. TO MOTORWAY CONNECTION
13	REF. TO MOTORWAY CONNECTION
14	REF. TO MOTORWAY CONNECTION
15	REF. TO MOTORWAY CONNECTION
16	REF. TO MOTORWAY CONNECTION
17	REF. TO MOTORWAY CONNECTION
18	REF. TO MOTORWAY CONNECTION
19	REF. TO MOTORWAY CONNECTION
20	REF. TO MOTORWAY CONNECTION
21	REF. TO MOTORWAY CONNECTION
22	REF. TO MOTORWAY CONNECTION
23	REF. TO MOTORWAY CONNECTION
24	REF. TO MOTORWAY CONNECTION
25	REF. TO MOTORWAY CONNECTION
26	REF. TO MOTORWAY CONNECTION
27	REF. TO MOTORWAY CONNECTION
28	REF. TO MOTORWAY CONNECTION
29	REF. TO MOTORWAY CONNECTION
30	REF. TO MOTORWAY CONNECTION
31	REF. TO MOTORWAY CONNECTION
32	REF. TO MOTORWAY CONNECTION
33	REF. TO MOTORWAY CONNECTION
34	REF. TO MOTORWAY CONNECTION
35	REF. TO MOTORWAY CONNECTION
36	REF. TO MOTORWAY CONNECTION
37	REF. TO MOTORWAY CONNECTION
38	REF. TO MOTORWAY CONNECTION
39	REF. TO MOTORWAY CONNECTION
40	REF. TO MOTORWAY CONNECTION
41	REF. TO MOTORWAY CONNECTION
42	REF. TO MOTORWAY CONNECTION
43	REF. TO MOTORWAY CONNECTION
44	REF. TO MOTORWAY CONNECTION
45	REF. TO MOTORWAY CONNECTION
46	REF. TO MOTORWAY CONNECTION
47	REF. TO MOTORWAY CONNECTION
48	REF. TO MOTORWAY CONNECTION
49	REF. TO MOTORWAY CONNECTION
50	REF. TO MOTORWAY CONNECTION
51	REF. TO MOTORWAY CONNECTION
52	REF. TO MOTORWAY CONNECTION
53	REF. TO MOTORWAY CONNECTION
54	REF. TO MOTORWAY CONNECTION
55	REF. TO MOTORWAY CONNECTION
56	REF. TO MOTORWAY CONNECTION
57	REF. TO MOTORWAY CONNECTION
58	REF. TO MOTORWAY CONNECTION
59	REF. TO MOTORWAY CONNECTION
60	REF. TO MOTORWAY CONNECTION
61	REF. TO MOTORWAY CONNECTION
62	REF. TO MOTORWAY CONNECTION
63	REF. TO MOTORWAY CONNECTION
64	REF. TO MOTORWAY CONNECTION
65	REF. TO MOTORWAY CONNECTION
66	REF. TO MOTORWAY CONNECTION
67	REF. TO MOTORWAY CONNECTION
68	REF. TO MOTORWAY CONNECTION
69	REF. TO MOTORWAY CONNECTION
70	REF. TO MOTORWAY CONNECTION
71	REF. TO MOTORWAY CONNECTION
72	REF. TO MOTORWAY CONNECTION
73	REF. TO MOTORWAY CONNECTION
74	REF. TO MOTORWAY CONNECTION
75	REF. TO MOTORWAY CONNECTION
76	REF. TO MOTORWAY CONNECTION
77	REF. TO MOTORWAY CONNECTION
78	REF. TO MOTORWAY CONNECTION
79	REF. TO MOTORWAY CONNECTION
80	REF. TO MOTORWAY CONNECTION
81	REF. TO MOTORWAY CONNECTION
82	REF. TO MOTORWAY CONNECTION
83	REF. TO MOTORWAY CONNECTION
84	REF. TO MOTORWAY CONNECTION
85	REF. TO MOTORWAY CONNECTION
86	REF. TO MOTORWAY CONNECTION
87	REF. TO MOTORWAY CONNECTION
88	REF. TO MOTORWAY CONNECTION
89	REF. TO MOTORWAY CONNECTION
90	REF. TO MOTORWAY CONNECTION
91	REF. TO MOTORWAY CONNECTION
92	REF. TO MOTORWAY CONNECTION
93	REF. TO MOTORWAY CONNECTION
94	REF. TO MOTORWAY CONNECTION
95	REF. TO MOTORWAY CONNECTION
96	REF. TO MOTORWAY CONNECTION
97	REF. TO MOTORWAY CONNECTION
98	REF. TO MOTORWAY CONNECTION
99	REF. TO MOTORWAY CONNECTION
100	REF. TO MOTORWAY CONNECTION

			
PERFETTI GROUP GENERATOR COOLING SYSTEM		BERTRAM ENGINEERING DEPT BERTRAM 450	
MODEL: B450		PART NUMBER: 2011-1	
DATE: 2011		DRAWING NO: 2011-1	
SCALE: 1:1		SHEET NO: 1	
TOTAL SHEETS: 1		DRAWING NO: 2011-1	

BERTRAM 450 GRAY WATER SYSTEM

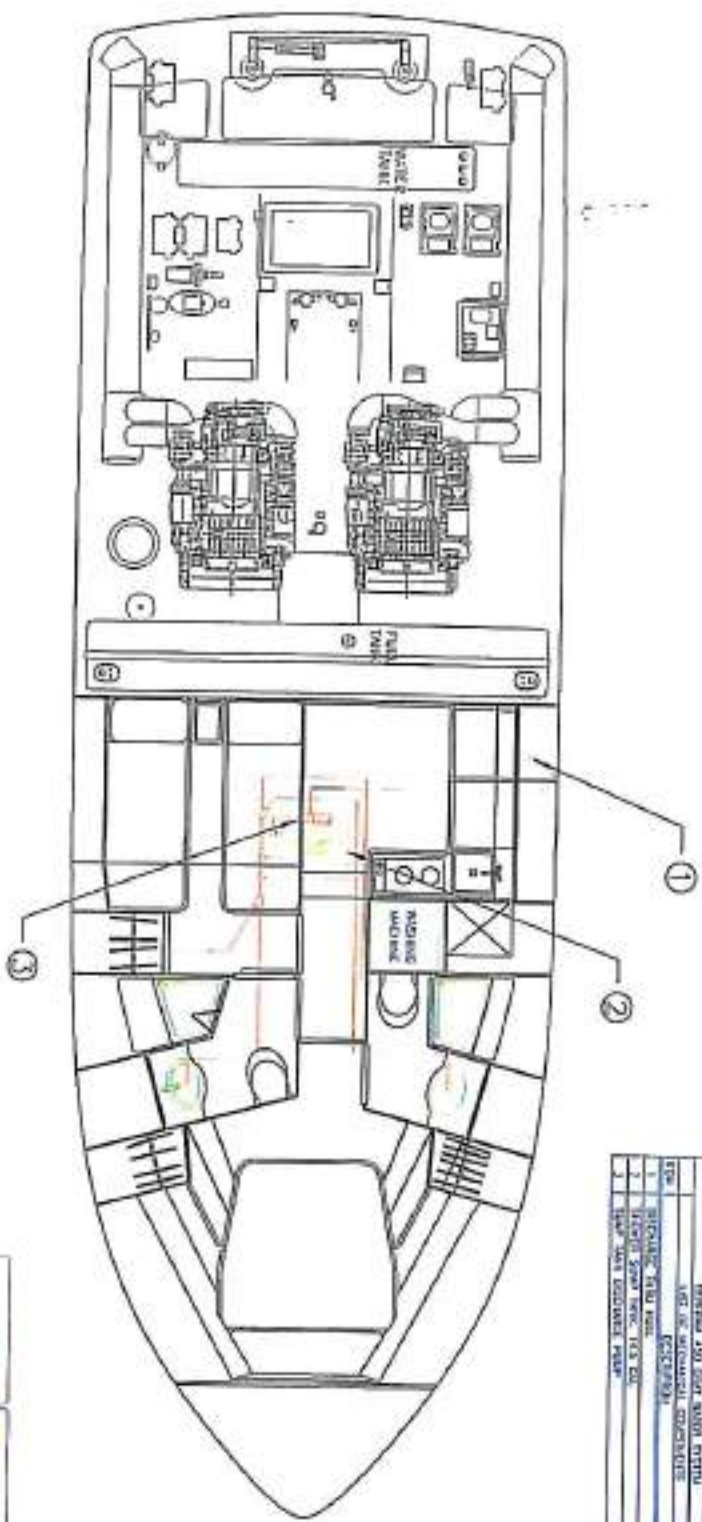

Bertram 450 Boat with Gray Water System	
List of Additional Equipment	
1	Gray Water Pump Motor
2	Gray Water Pump Tank
3	Gray Water Pump Tank

BERTRAM ENGINEERING DEPT.

GRAY WATER SYSTEM

B450

B

Copyright © 2000 Bertram Yacht Corporation

BERTRAM 450
HELM STATION

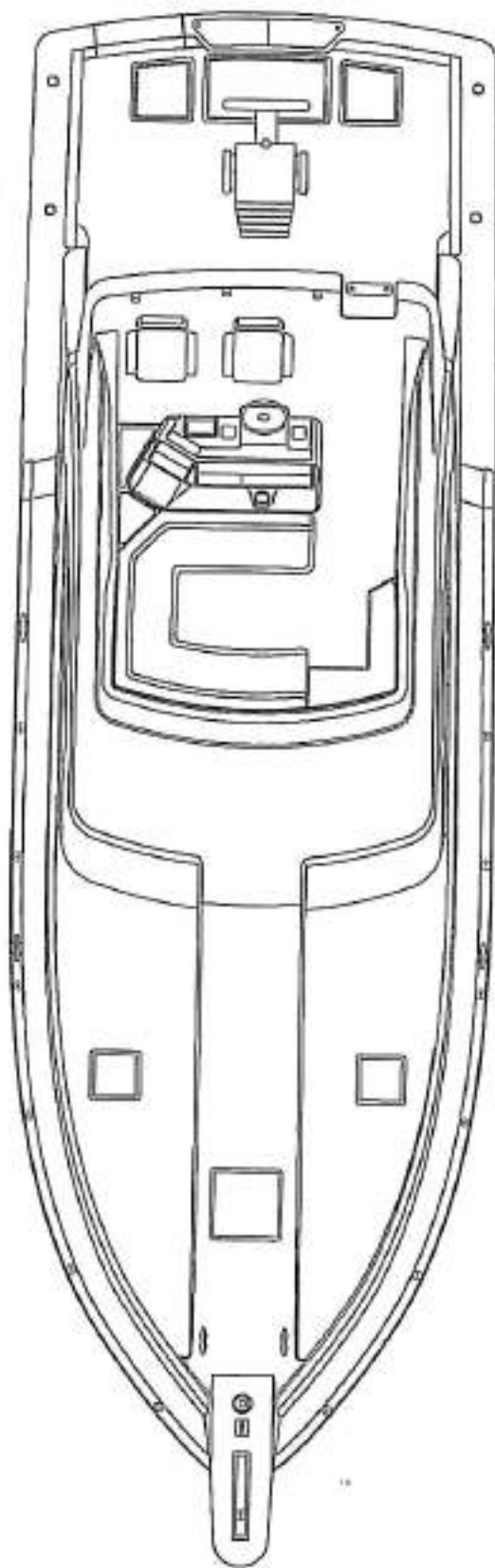

			
BERTRAM GROUP		BERTRAM ENGINEERING DEPT.	
HELM STATION			
MODEL: B450	PART NO.:	REV. NO.:	DATE:
DRAWN BY:	CHECKED BY:	APPROVED BY:	DATE:
BERTRAM GROUP, 10000 W. 10TH AVENUE, SUITE 100, DENVER, CO 80231, USA			

BETRIEF VAN DE BOORTEN (L) (R)	
1	RECHTERE DEUR (R)
2	RECHTERE DEUR (L)
3	RECHTERE DEUR (R)
4	RECHTERE DEUR (L)
5	RECHTERE DEUR (R)
6	RECHTERE DEUR (L)
7	RECHTERE DEUR (R)
8	RECHTERE DEUR (L)
9	RECHTERE DEUR (R)
10	RECHTERE DEUR (L)
11	RECHTERE DEUR (R)
12	RECHTERE DEUR (L)
13	RECHTERE DEUR (R)
14	RECHTERE DEUR (L)

BERTRAM 450
MECHANICAL LAYOUT

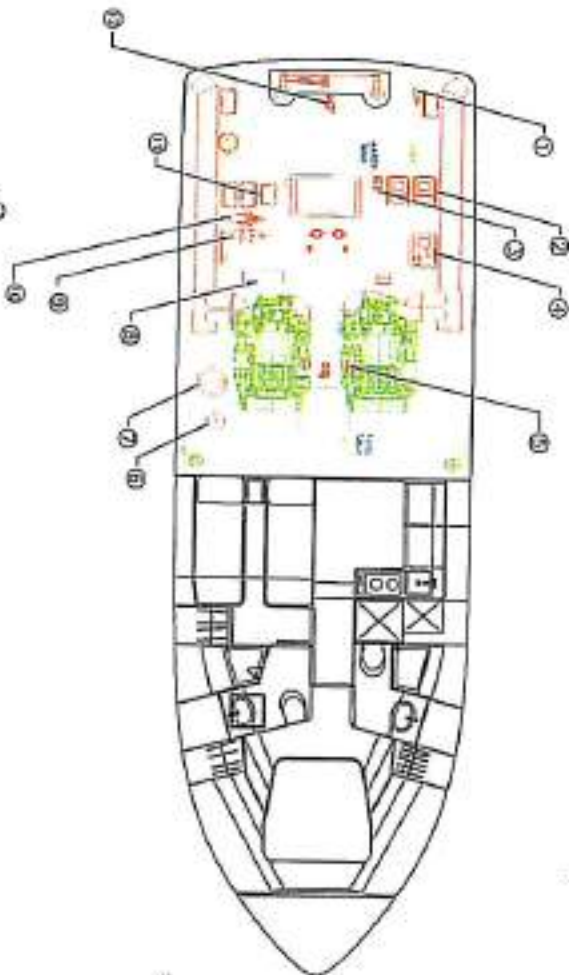

			
PERAZZETTI ENGINEERING MECHANICAL LAYOUT		BERTRAM ENGINEERING DEPT.	
Model: B450 Version: B	Date: 15/05/2018 Drawn: ... Checked: ...	Scale: 1:1 Sheet: 1 of 1	Project: ... Client: ...

BERTRAM 450 TOILET SYSTEM

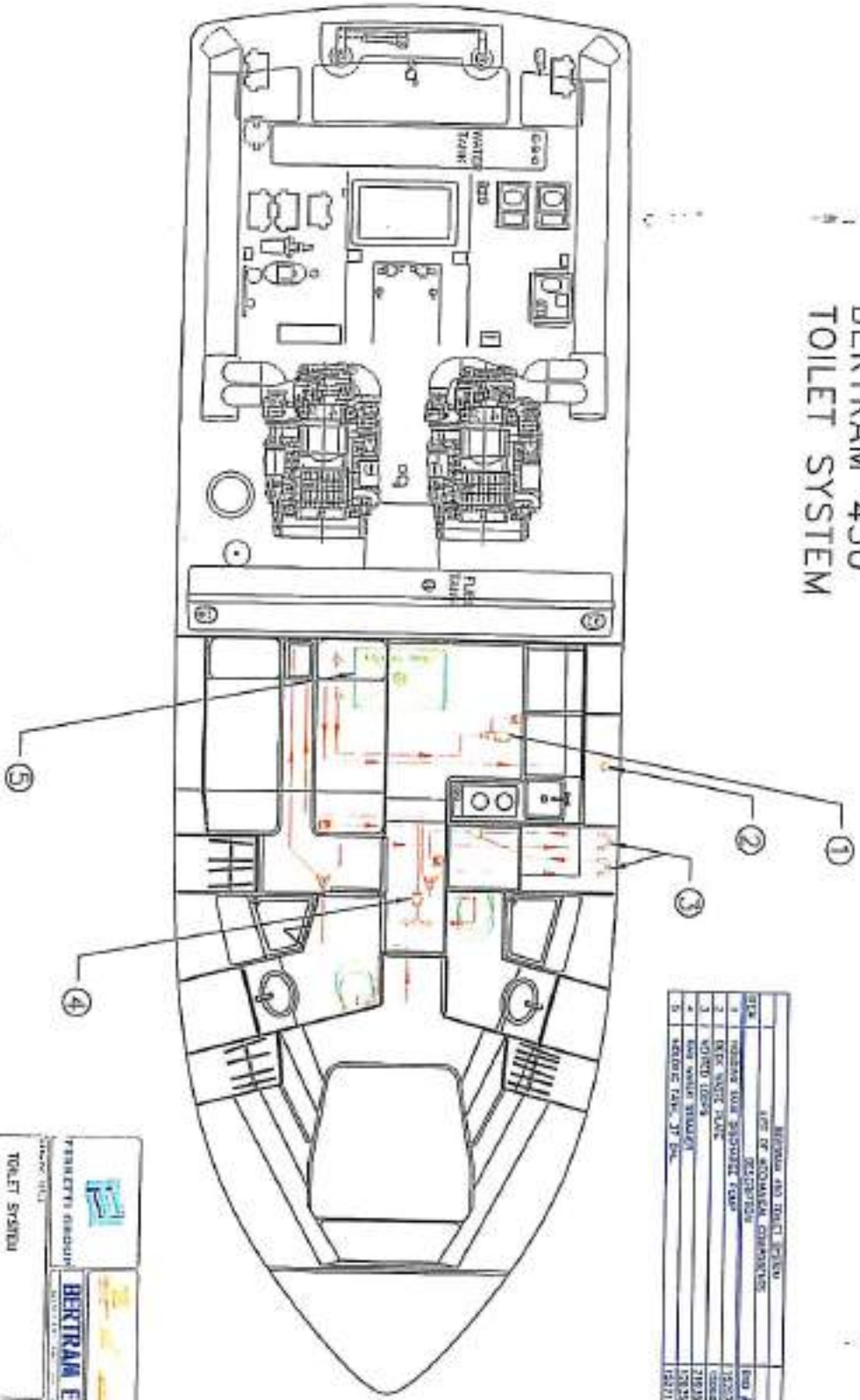

Access and Part List	
ITEM	QTY
1	WATER TANK 25L/5.5GAL
2	WATER TANK 25L/5.5GAL
3	FLUSH TANK 25L/5.5GAL
4	TOILET UNIT
5	TOILET UNIT

BERTRAM ENGINEERING DEPT

TOILET SYSTEM

B450

DATE: 1998

REV: 1

SCALE: 1:1

BY: [Signature]

CHECKED: [Signature]

APPROVED: [Signature]

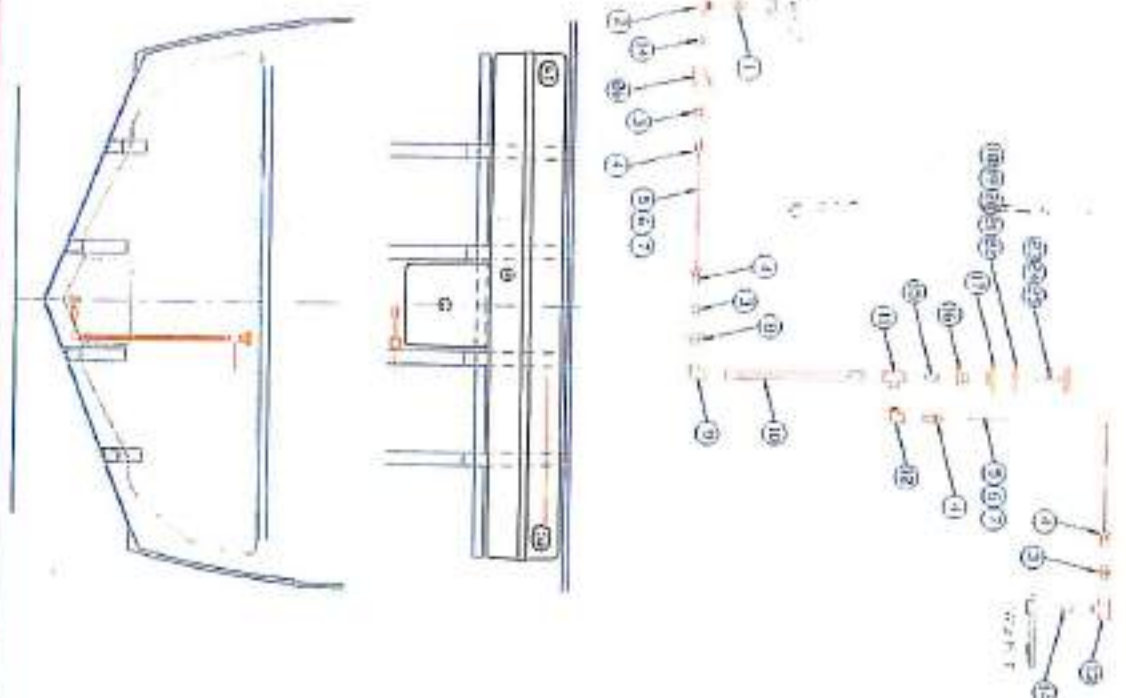

ITEM	DESCRIPTION	QTY	NO.
1	EA BUSHING, 1/2" ID x 1/2" OD x 1/2" TH. 3P	21313	
2	EA CUSHION, 18" x 12" x 1/2" TH. 5P	21392	
3	EA BUSHING, 1/2" ID x 1/2" OD x 1/2" TH. 3P	21398	
4	EA FITTING, 1/2" ID x 1/2" OD x 1/2" TH. 3P	21399	
5	EA FITTING, 1/2" ID x 1/2" OD x 1/2" TH. 3P	21400	
6	EA FITTING, 1/2" ID x 1/2" OD x 1/2" TH. 3P	21401	
7	EA FITTING, 1/2" ID x 1/2" OD x 1/2" TH. 3P	21402	
8	EA FITTING, 1/2" ID x 1/2" OD x 1/2" TH. 3P	21403	
9	EA FITTING, 1/2" ID x 1/2" OD x 1/2" TH. 3P	21404	
10	EA FITTING, 1/2" ID x 1/2" OD x 1/2" TH. 3P	21405	
11	EA FITTING, 1/2" ID x 1/2" OD x 1/2" TH. 3P	21406	
12	EA FITTING, 1/2" ID x 1/2" OD x 1/2" TH. 3P	21407	
13	EA FITTING, 1/2" ID x 1/2" OD x 1/2" TH. 3P	21408	
14	EA FITTING, 1/2" ID x 1/2" OD x 1/2" TH. 3P	21409	
15	EA FITTING, 1/2" ID x 1/2" OD x 1/2" TH. 3P	21410	
16	EA FITTING, 1/2" ID x 1/2" OD x 1/2" TH. 3P	21411	
17	EA FITTING, 1/2" ID x 1/2" OD x 1/2" TH. 3P	21412	
18	EA FITTING, 1/2" ID x 1/2" OD x 1/2" TH. 3P	21413	
19	EA FITTING, 1/2" ID x 1/2" OD x 1/2" TH. 3P	21414	
20	EA FITTING, 1/2" ID x 1/2" OD x 1/2" TH. 3P	21415	
21	EA FITTING, 1/2" ID x 1/2" OD x 1/2" TH. 3P	21416	
22	EA FITTING, 1/2" ID x 1/2" OD x 1/2" TH. 3P	21417	
23	EA FITTING, 1/2" ID x 1/2" OD x 1/2" TH. 3P	21418	
24	EA FITTING, 1/2" ID x 1/2" OD x 1/2" TH. 3P	21419	
25	EA FITTING, 1/2" ID x 1/2" OD x 1/2" TH. 3P	21420	
26	EA FITTING, 1/2" ID x 1/2" OD x 1/2" TH. 3P	21421	

DATE	2/10/11	BY	W
REVISED			
NO. OF SHEETS	1	TOTAL SHEETS	1
SCALE	AS SHOWN		
PROJECT	BEETRAH FACILITY		
	WASH. STATE, USA		

TABLE OF CONTENTS

1 FORWARD	
2 DOCUMENTATION	
2 WARNINGS, CAUTIONS, and NOTES	
3 U.S. COAST GUARD REGULATIONS	
4 VESSEL INFORMATION	
5 TECHNICAL DATA	
7 MECHANICAL SYSTEMS	
7 Propulsion System	
7 Fuel System	
8 Engine/Shaft Alignment	
9 Propellers	
9 Propeller Installation	
10 Propeller Hazard	
10 Propeller Shafts	
10 Propeller Shaft Seals	
10 Propeller Shaft Replacement	
11 Rudder Alignment	
11 Rudder Seals	
11 Bilge Pump Systems	
11 Oil Discharge Warning	
12 Emergency Bilge Pump	
13 Toilet (Head) System	
14 Fresh Water System	
16 Gray Water System	
17 Seawater System	
17 Washdown System	
18 Windlass	
19 Cablemaster	
20 ELECTRICAL SYSTEMS	
20 D.C. Electrical System	
22 Ventilation Systems	
23 Navigation Lights	
23 A.C. Electrical System	
25 Generator	
29 Telephone	
29 Cable TV	
29 FIRE SYSTEM and MONITOR	
32 Firefighting Plan	
33 Classes of Fire	
34 PERFORMANCE	
34 Hull Efficiency	
34 Marine Growth	
35 Water in the Bilge	
35 Atmospheric Conditions	
35 CONTROL, MANEUVERING, and SAFETY	
35 Main Engines	
36 Engine Instruments	
39 Steering System	
40 Trim Tab System	
41 Engine Control and Maneuvering	
41 Aft-Control Station	
42 While Underway	
42 Prudent Boat Speed	
42 Slow Speed Maneuvering	
42 Cruising Speed Maneuvering	
43 Compass	
44 Draft	
45 Grounding	
46 Height Above Water Line	
47 Towing	
48 Heavy Weather Checklist	
48 Man Overboard	
49 Personal Floatation Devices	
49 Visual Distress Signals	
50 Abandon Ship Drill	
50 Overhead Rod Locker	
51 Carbon Monoxide Poisoning	
52 GENERAL MAINTENANCE and CARE	
53 Diesel Fuel	
53 Oil-Soaked Wipes	
54 Electrical Repairs	
54 Hatch Dog Adjustment	
55 Non-Fiberglass Plastics	
55 Fiberglass Care	
55 Crevice Corrosion	
56 Galvanic Corrosion	
56 Stray Current Corrosion	
57 Aluminum Railings	
57 Stainless Steel	
57 MISC. SYSTEMS and ACCESSORIES	
57 Air Conditioning System	
58 Central Vacuum System	
59 Swim Platform	
59 OWNER'S RESPONSIBILITIES	
60 APPENDIX:	
DRAWINGS	
GLOSSARIES	