

Prologue

<https://www.boat-manuals.com/> Materials (Fabric)

AB Inflatables has been manufacturing boats since 1968. Each AB Boat is carefully hand-crafted with the finest materials on the market. Our driving force is our commitment to quality and continuous improvement. We build all our inflatables with the same exacting care and attention to detail and durability, therefore we have chosen to manufacture our inflatables with the finest (CSM) Coated Fabric , proven durable in all climates and conditions. Every AB craft undergoes strict pressure tests, seam and adhesive bond inspections, and a rigorous quality control process, to provide you with unsurpassable quality and durability. Whether your needs run to commercial, rugged personal use or pure pleasure, an AB inflatable is virtually indestructible and unsinkable.

At AB we combine superior design with meticulous craftsmanship and proven materials, such as 5-ply (CSM) Coated Fabric, to create unmatched tube quality. At AB Inflatables we use 1,100 Decitex polyester material on all our models except models 24 VST and larger which are manufactured with 1,670 Decitex (1518 Dernier)

-
- A. COLORED (CSM) Coated Fabric SHEET
 - B. COLORED NEOPRENE SHEET
 - C. ADHESION SYSTEM
 - D. POLYESTER TEXTILE HIGH TENACITY
 - E. BLACK NEOPRENE SHEETS

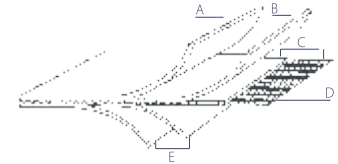

CONSTITUTION OF (CSM) COATED FABRIC

Deck Plans + Profile

Rigid Hull Model



Declaration of Conformity

Application of EU Recreational Craft Directive 94/25/EC as amended by 2003/44/EC

Standard(s) to which conformity is declared

RSG Guidelines
ISO/DIS 6185-2
ISO/DIS 6185-3

Design Category:

"B" Offshore: Craft designed for offshore voyages where conditions up to and including wind force 8 (Beaufort scale) and significant wave heights up to and including 4 metres (13.12 ft) may be experienced. "C" Inshore: Craft designed for voyages in coastal waters, large bays, estuaries, lakes and rivers, where conditions up to and including wind force 6 (Beaufort Scale) and significant wave heights up to and including 2 metres (6.56 ft) may be experienced.

Manufacturer's Name

AB MARINE GROUP

Manufacturer's Address

AB Marine Group, Calle 1E N° 2-15, Bodega N° 9, Zona Franca de Barranquilla, Colombia. Phone: +57(5) 379.5132. Fax: +57(5) 379.5667

Certifying Body

HPi Verification Services Ltd
EU Notified Body number 1521
The Manor House, Howbery Park, Wallingford, OX10 8BA
United Kingdom
Web site: www.hpivs.com
Email: enquiries@hpivs.com



The CE mark allows us as manufacturer to perform a declaration of conformity per boat when it is needed. Please contact us if you need this certification or further information.

ABYC: American Boat & Yacht Council

NMMA: National Marine Manufacturers Association

231 S .LaSalle Street, Suite 2050

Chicago, IL.60604 U.S.A.

Phone: (312) 946-6200

Web site: www.nmma.org

Email: _webmaster@nmma.org

Type of Equipment: Inflatable Recreational Craft

Serial N° Type

Year of Manufacture

I, the undersigned, hereby declare that the equipment specified above conforms to the above Directive(s) and Standard(s).

Full Name: Ivor W. Heyer Date: June 1, 2012



CERTIFICATION

<https://www.boat-manuals.com/>

No	Models	HPI 2016 Certification	CE CAT	ISO 6185	Type
1	Nautilus 11 DLX	HPIVS/R1088-125-I-01	C	3	VII
2	Nautilus 12 DLX	HPIVS/R1088-126-I-01	C	3	VII
3	Nautilus 13 DLX	HPIVS/R1088-127-I-01	C	3	VII
4	Nautilus 14 DLX	HPIVS/R1088-128-I-01	C	3	VII
5	Nautilus 15 DLX	HPIVS/R1088-129-I-01	C	3	VII
6	Nautilus 17 DLX	HPIVS/R1088-130-I-01	C	3	VIII
7	Nautilus 19 DLX	HPIVS/R1088-131-I-01	C	3	VIII
8	Nautilus 19 DLX-I/O	HPIVS/R1088-132-I-01	C	3	VIII
9	Oceanus 11 VST	HPIVS/R1088-082-I-01	C	3	VII
10	Oceanus 12 VST	HPIVS/R1088-083-I-01	C	3	VII
11	Oceanus 13 VST	HPIVS/R1088-084-I-01	C	3	VII
12	Oceanus 14 VST	HPIVS/R1088-085-I-01	C	3	VII
13	Oceanus 15 VST	HPIVS/R1088-086-I-01	C	3	VII
14	Oceanus 17 VST	HPIVS/R1088-087-I-01	C	3	VIII
15	Oceanus 19 VST	HPIVS/R1088-088-I-01	C	3	VIII
16	Oceanus 21 VST	HPIVS/R1088-089-I-01	C	3	VIII
17	Oceanus 24 VST	HPIVS/R1088-140-I-01	C B	3	VIII
18	Oceanus 28 VST	HPIVS/R1088-141-I-01	C B	4	X
19	19 MACC	HPIVS/R1088-137-I-01	C	3	VIII
20	19 OPEN				

No	Models	HPI 2016 Certification	CE CAT	ISO 6185	Type
21	Navigo 8 VS	HPIVS/R1088-090-I-01	C	2	V
22	Navigo 9 VS	HPIVS/R1088-091-I-01	C	2	V
23	Navigo 10 VS	HPIVS/R1088-092-I-01	C	3	VII
24	Navigo 12 VS	HPIVS/R1088-093-I-01	C	3	VII
25	Navigo 13 VS	HPIVS/R1088-094-I-01	C	3	VII
26	Navigo 14 VS	HPIVS/R1088-095-I-01	C	3	VII
27	Navigo 15 VS	HPIVS/R1088-096-I-01	C	3	VII
28	Navigo 17 VS	HPIVS/R1088-097-I-01	C	3	VIII
29	Navigo 19 VS	HPIVS/R1088-098-I-01	C	3	VIII
30	Navigo 21 VS	HPIVS/R1088-099-I-01	C	3	VIII
31	Mares 10 VSX	HPIVS/R1088-138-I-01	C	3	VII
32	Mares 12 VSX	HPIVS/R1088-139-I-01	C	3	VII
33	Ventus 8 VL	HPIVS/R1088-133-I-01	C	2	V
34	Ventus 9 VL	HPIVS/R1088-134-I-01	C	2	V
35	Ventus 10 VL	HPIVS/R1088-135-I-01	C	3	VII
36	Ventus 12 VL	HPIVS/R1088-136-I-01	C	3	VII
37	Lamina 8 AL	HPIVS/R1088-100-I-01	C	1	II

No	Models	HPIV 2016 Certification	CE CAT	ISO 6185	Type
38	Lamina 9 AL	HPIVS/R1088-101-I-01	C	2	V
39	Lamina 9,5 AL	HPIVS/R1088-102-I-01	C	2	V
40	Lamina 10 AL	HPIVS/R1088-103-I-01	C	2	V
41	Lamina 11 AL	HPIVS/R1088-104-I-01	C	3	VII
42	Lamina 12 AL	HPIVS/R1088-105-I-01	C	3	VII
43	Lamina 13 AL	HPIVS/R1088-106-I-01	C	3	VII
44	Lamina 14 AL	HPIVS/R1088-107-I-01	C	3	VII
45	Lamina 15 AL	HPIVS/R1088-108-I-01	C	3	VII
46	Lamina 16 AL	HPIVS/R1088-109-I-01	C	3	VII
47	Lamina 18 AL	HPIVS/R1088-110-I-01	C	3	VIII
48	AB Rider	HPIVS/R1088-145-I-01	C	3	VII
49	Lamina 8 UL	HPIVS/R1088-113-I-01	C	1	II
50	Lamina 9 UL	HPIVS/R1088-114-I-01	C	2	V
51	Lamina 10 UL	HPIVS/R1088-115-I-01	C	2	V
52	Alumina 9,5 ALX	HPIVS/R1088-116-I-01	C	2	V
53	Alumina 10 ALX	HPIVS/R1088-117-I-01	C	3	VII
54	Alumina 11 ALX	HPIVS/R1088-118-I-01	C	3	VII
55	Alumina 12 ALX	HPIVS/R1088-119-I-01	C	3	VII
56	Alumina 13 ALX	HPIVS/R1088-120-I-01	C	3	VII

No	Models	HPIV 2016 Certification	CE CAT	ISO 6185	Type
57	Alumina 14 ALX	HPIVS/R1088-121-I-01	C	3	VII
58	Alumina 15 ALX	HPIVS/R1088-122-I-01	C	3	VII
59	Alumina 16 ALX	HPIVS/R1088-123-I-01	C	3	VII
60	Alumina 18 ALX	HPIVS/R1088-124-I-01	C	3	VIII
61	Profile A 11	HPIVS/R1088-104-I-01	C	3	VII
62	Profile A 12	HPIVS/R1088-105-I-01	C	4	VII
63	Profile A 13	HPIVS/R1088-106-I-01	C	5	VII
64	Profile A 14	HPIVS/R1088-107-I-01	C	6	VII
65	Profile A 15	HPIVS/R1088-108-I-01	C	7	VII
66	Profile A 16	HPIVS/R1088-109-I-01	C	8	VII
67	Profile A 18	HPIVS/R1088-110-I-01	C	3	VIII
68	Profile A 21	HPIVS/R1088-111-I-01	C	3	VIII
69	Profile A 24	HPIVS/R1088-112-I-01	C	3	VIII
70	Profile F 14	HPIVS/R1088-095-I-01	C	3	VII
71	Profile F 15	HPIVS/R1088-096-I-01	C	3	VII
72	Profile F 17	HPIVS/R1088-097-I-01	C	3	VIII
73	Profile F 19	HPIVS/R1088-098-I-01	C	3	VIII
74	Profile F 21	HPIVS/R1088-099-I-01	C	3	VIII
75	Profile F 24	HPIVS/R1088-140-I-01	C B	3	VIII
76	Profile F 28	HPIVS/R1088-141-I-01	C B	4	X

This manual is not intended to provide complete training on all aspects of boat operation. We strongly recommend that all operators of this boat seek additional training on boat handling and safety.

Safety requirements differ from country to country, from state to state and whether you're within coastal waters or inland waters. For more detailed information check with the local authorities.

Your AB inflatable is already a safety device all by itself, due to its numerous air chambers, but the law also requires at least one Type I, II or III Personal Flotation Device (PFD) for each person on board or towed on water skis; and in addition, one throwable Type IV PFD. As the owner, obtaining PFDs and other necessary safety equipment is your responsibility.

PFDs are intended to help you save your own life; you and your passengers should wear a PFD whenever boating. Many countries/states require children, age 18 or younger, to wear PFDs at all times. It is especially important that children or non-swimmers wear a PFD. Make certain you know how to use PFDs. Try it on and make adjustments for a comfortable fit. Show children how to properly put on a PFD.

Notice

Special PFDs are available for skiing and other water sports. These PFDs are constructed with materials suitable for high impact falls into the water.

Warning

It is a requirement that you carry at least one B-1 type Coast Guard approved portable marine fire extinguisher on all our models with prefitted fuel tanks.

Danger

- When operating, occupants **MUST AVOID** standing up or sitting with their feet hanging over the gunwale.
- Leaking fuel is a fire & explosion hazard. Inspect fuel system regularly.
- Shut off engine before reboarding from the water.

Depending on the model you have chosen, we recommend you include many or all of the following items:

Anchor & anchor line	Mooring lines
Bailer	Oars/paddles
Batteries	PFDs
Bellows	Portable marine fire extinguisher
Charts	Portable radio with weather band
Engine tools	Spare keys
Extra fuel	Sunscreen lotion
First aid kit	Tool kit
Flares	VHF
Fresh water	Waterproof flashlight
Maintenance kit	

Boating Terminology

- 1. Stern
- 2. Waterline
- 3. Bow
- 4. Freeboard
- 5. Keel
- 6. Forward
- 7. Aft
- 8. Beam
- 9. Transom
- 10. Length Overall
- 11. Starboard side
- 12. Port side

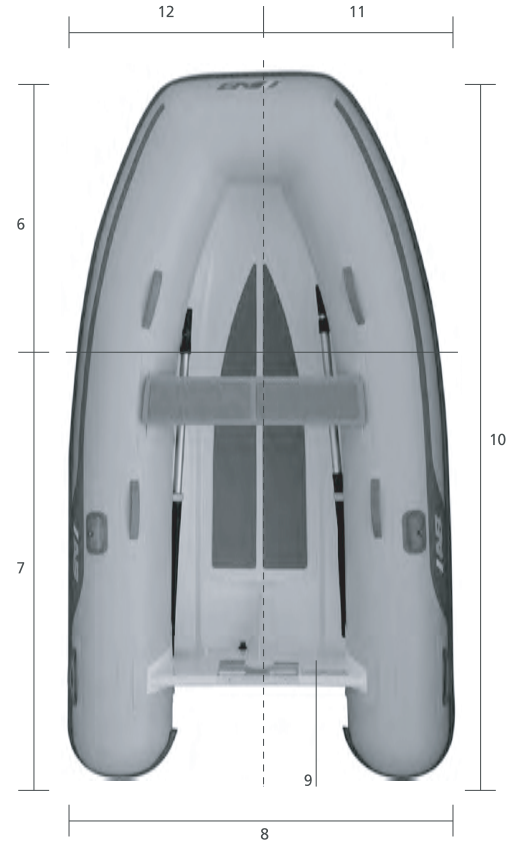
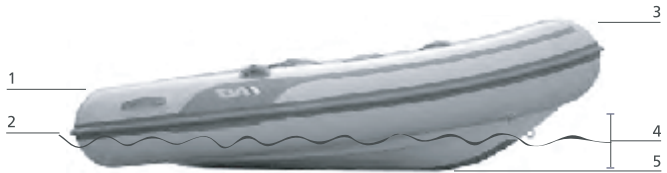

Identification Numbers

Safeguard the information about your boat by recording the Hull Identification Number (HIN) and model of your boat on the inside front cover of this manual. The HIN is located on the upper starboard corner of the transom. The HIN must be clearly visible at all times and must not be removed, altered or tampered with in any way. The Identification Number is very important! Keep a copy of this number stored in a safe place off the boat. In case of theft, damage, warranty claims, etc., report this number to the local authorities, your insurance agent and your dealer.

General Description

The Hull

The buoyancy chamber or tube is "U" shaped with rounded airtight cones in the same material, ensuring complete safety and seaworthiness. AB uses large tubes for each boat size to increase payload capabilities and to give you a dry ride. In addition, each tube is "U" shaped and sized proportionately to the boat's hull dimensions which maximises internal space.

The bottom of your AB boat is made out of aluminium or fibreglass, providing you with unsurpassable seaworthiness. Models DLX & VST contain a pre-fitted marine grade aluminium fuel tank, and some DLX & VST models an underdeck freshwater tank.

The Transom

At the stern a special marine transom is fixed to the hull to support the outboard engine. The transom is made of a composite of marine grade plywood (a min. of 20mm to a max. of 50mm / (0.787 "to 1.968")) and fibreglass which is equipped with an engine mounting plate.

Caution

Do not drill holes or screw objects in the deck or transom without sealing the holes. Failure to do so will result in water penetration and eventually will cause delamination.

Warning

In the models with pre-fitted fuel & fresh water tanks, do not drill holes in the deck deeper than 1.27 cm (1/2"). Otherwise the tanks will be perforated. Fuel leaks could occur, which if ignited may cause serious injury or death.

Danger

Do not drill holes on the deck of any boat that contains a full or partially full fuel tank. Trapped gases in the tank could explode, causing serious injuries or death.

Assembly

<https://www.boat-manuals.com/>

Inflating Instructions

Hard bottom dinghies or R.I.B's, as they are frequently called, require very little preparation before launching. Simply inflate the buoyancy chambers, fit the removable accessories that come standard with your AB, attach the outboard engine and include the fuel tank (except models "DLX & VST") and the safety equipment required. For more detailed information, please read the Marine Safety chapter in this manual.

At the same time, make sure your boat has the hull and condensation (if applicable) drain plugs tightened into the valves before launching the boat. For more information, read the Hull & Deck Drain Plug chapter in this manual.

The inflating system includes the inflation valves and a hand pump with its valve connector.

The Inflation Valves: The inflation valves are plastic, therefore non-corrosive and double sealed for safety. The valve is divided into two pieces, one is located on the inner side of the buoyancy chamber. The other is screwed to the afore-mentioned piece from the outside of the buoyancy chamber. This last piece is composed of a one-way check valve, a diaphragm and a cap. This screw-on system enables you to remove and replace a damaged valve very easily.

The inflation valves are designed with a push-push system, this system consists of a rod-spring type gate that allows or prevents the flow of air into the air chambers. In this way, when you push the rod-spring located in the valve this remains open permanently. When pushing back the rod-spring, this will close and seal the valve.

Note that in the end of the hand pump hose, located in the center of the adapter, you may find an adjustable screw. When you insert the hose adapter hand pump in the inflation valve, the screw presses the valve rod-spring by making the inflate process easier. The adjustment in the height of the screw allows the user to adapt to the needs of the buoyancy chambers.



INFLATION VALVE



HAND PUMP

To Inflate: Push the end of the bellows hose with the correct valve connector into place on the valve as far as possible and turn clockwise until the valve connector locks in place. Compress the hand pump gently and unhurriedly. When inflated, screw the plastic cap onto the valve until it is fully seated.



CONNECTION OF HOSE ADAPTER TO VALVE

Inflating Instructions

Warning

Never use a gasoline service station or high compression pumps to inflate your boat. They could damage the buoyancy collar.

Air tightness is obtained partly by means of the plunger one-way check valve that is set in the base of the valve insert; complete air-tightness is ensured by the properly fitted valve cap. Before screwing on the cap, check that the valve is clean, free from sand, weeds or other debris.

To deflate: Remove the cap and with your finger, push down the spring loaded plunger in the centre of the valve. To deflate totally you may want to lock the plunger down.

The Hand Pump, also called Cylindrical Pump: To inflate your boat, connect the valve connector appropriate for the valve. Put the pump in an upright position and step onto the tongues, located at the bottom of the pump. The hand pump is a double-action one. Each time you lift and push the handle, 4lts. (1 gallon) of air will enter the buoyancy chambers. The hand pump comes with two connections; one for inflation the other for deflation.

The Buoyancy Chambers: Depending on the model you have chosen it will have two or more air chambers. For specific information on your boat turn to the chapter on Specifications. The more chambers it has, the safer it will be. Each chamber is divided from the other by a special baffle system that keeps our multiple air chambers completely sealed off from one another, while working to equalise air pressure between compartments. It is advisable to inflate your boat properly and check the pressure frequently. The pressure should be maintained at 0.20 bar (3 psi) in the buoyancy chambers. (A pressure gauge is not included with the boat).

A good rule of thumb is: When you cannot depress the tube more than 1 cm (1/2 inch) with the pressure of your finger, you have then reached approximate working pressure.

Important: The correct way to inflate the air chambers is by inflating the aft chambers first, and then those towards the bow. When the inflatable buoyancy chambers have been inflated, screw the cap on the valve properly in order to secure final air-tightness. The buoyancy tubes must be inflated to the recommended pressure otherwise the craft will perform inefficiently. When the buoyancy tube cannot be depressed by finger pressure, the approximate working pressure has been reached.

Notice

The pressure of the boat fluctuates with change in temperature. Pressure increases after prolonged exposure to sun, and falls when the boat is launched and when in darkness. Do not worry about this.

We have seen experienced people send boats over for repair which were in excellent condition that either lost air due to a loose air valve, or because of shifts in temperature.

Warning

Care should be taken not to allow a boat which has been fully inflated in the cool of the morning to stand in direct sunlight. Buoyancy pressure will quickly raise with the temperature and could strain or cause serious damage to the buoyancy tube.



COMPRESS THE HAND PUMP GENTLY AND UNHURRIEDLY

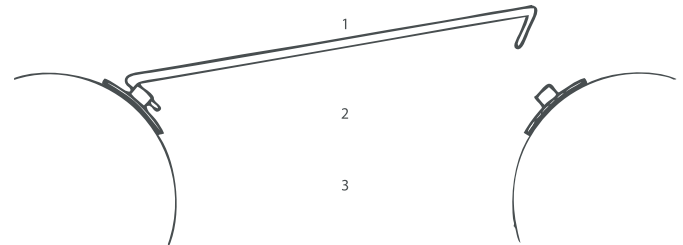

1. REMOVABLE ROWING SEAT
2. (CSM) COATED FABRIC SEAT RETAINER
3. BOUYANCY TUBE



THE REMOVABLE SEAT IS EASIER TO FIT IF THE BOUYANCY CHAMBER IS SLIGHTLY DEFLATED

Fitting & Assembly of Oars

<https://www.boat-manuals.com/>

Hull & Deck Drain Plug

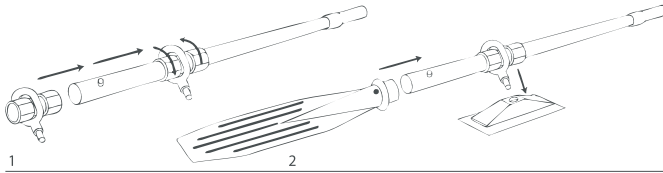

FOLLOWING THE CORRECT ASSEMBLY OF THE OARS, THE PINTYPE OARLOCKS MAY BE FITTED TO PERMANENTLY ATTACHED OAR LOCK BASES AS SHOWN IN THE ILLUSTRATION: FULLY SEAT THE OARLOCK INTO THE SLEEVE PORTION OF THE BASE BY ALIGNING THE FLAT PORTION OF THE OARLOCK PIN, AND THE FIXED PIN WITHIN THE SLEEVE OF THE BASE. WHEN FULLY SEATED IN THE BASE, ROTATE THE OAR ASSEMBLY 180 DEGREES TO LOCK THE OAR INTO POSITION. AFTER CORRECT ASSEMBLY, THE OAR AND PIN-TYPE OARLOCK WILL NOT PULL OUT OF THE OARLOCK BASE. DISASSEMBLY OF THE OARS AND OARLOCKS IS PERFORMED IN THE REVERSE ORDER.

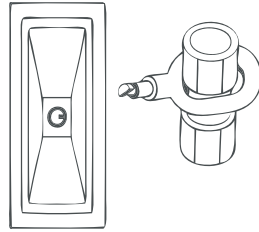

3

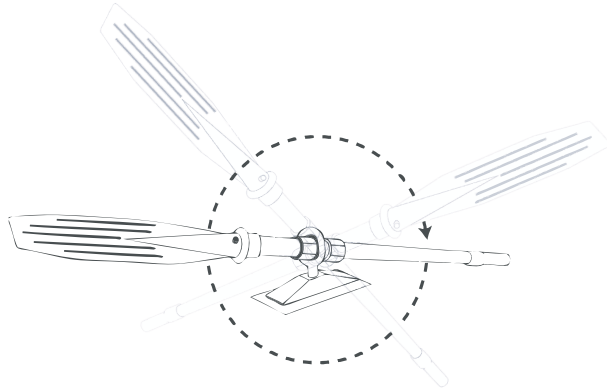

4



1

2

1. DRAIN SOCKET WITH O-RING & SAFETY PLUG

2. EXPANDING DRAIN PLUG FOR RIBS

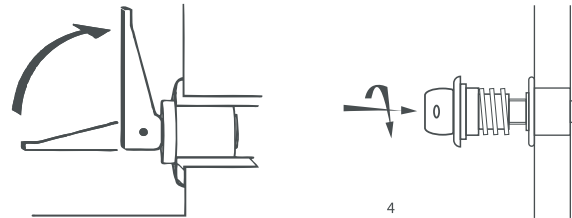

3. TO FIT THE HULL DRAIN PLUG:

- THE DECK DRAIN PLUG IS A SCREW FIT INTO THE FLANGE
- PUSH THE PLUG INTO SLEEVE LOCATED IN THE TRANSOM
- TO LOCK, LIFT HANDLE THROUGH 90° AS SHOWN BY ARROW

4. TO FIT DECK DRAIN PLUG, ALSO CALLED THE CONDENSATION VALVE:

- THE DECK DRAIN PLUG IS A SCREW FIT INTO THE FLANGE
- MAKE SURE O-RING IS IN PLACE
- TURN ANTICLOCKWISE TO UNDO, AND CLOCKWISE TO TIGHTEN

Hull & Deck Drain Plug

Note 1: When open, the deck drain plug is retained by the flange. You should periodically remove it to empty any water build up from between deck and hull.

Note 2: If leaving the boat on davits or storing it out of the water, remove both drain plugs so rain water may drain and/or condensation evaporate.

Caution

Before launching the boat, make sure both plugs are secured into the valves.

Danger

Do not open either the hull drain plug or the deck drain plug while afloat, i.e. when the boat is NOT in motion.

Fuelling & Fuel System

Please check the specifications chapter to confirm if your craft comes standard with a pre-fitted marine-grade aluminium underdeck fuel tank, and its capacity. If the craft you have chosen does not come standard with a pre-fitted fuel tank, a portable one should be supplied with the outboard engine.

Caution

Portable tanks must be removed from the boat when fuelling.

The pre-fitted fuel tank is permanently installed underneath the deck. Where necessary the craft is equipped with removable inspection plates for fuel system component inspection.

Fuel lines, vent hoses and drain hoses should be checked frequently for leaks. If leaking occurs, inspect the fuel system connections. If they are too tight or too loose they may leak. If upon tightening or loosening the connection, the leak persists, replace the hose. If hose presents surface cracking, is dry or mushy replace immediately. If fittings show damage due to abrasion or rust, replace immediately.

Notice

- Take care not to spill gasoline. If gasoline is spilled, use dry rags or sponges to soak up the fuel and dispose of them properly onshore. Discharging fuel or oily waste in navigable waters is prohibited. Help protect your waters.
- Make sure you are using the filler pipe marked "Fuel".

Warning

- Replace with certified marine parts only. Do not use automotive parts.
- Gasoline is extremely flammable and highly explosive. When refuelling, always turn off the engine, never smoke or allow open flames or sparks within 15 metres (50 feet) of the fuelling area.
- Do not store flammable material in a non-vented area.
- Do not fill tank to capacity. Allow for fuel expansion.
- Do not drill holes in the deck deeper than 1.27 cms. (1/2"). Otherwise the fuel tank will be perforated. Fuel leaks could occur, which if ignited may cause serious injury or death.

Underdeck Pre-fitted FreshWater Tank

Please check the specifications chapter to confirm if your craft comes standard with a pre-fitted marine-grade aluminium underdeck fresh water tank, and its capacity.

Notice

Make sure you are using the filler pipe marked "Water".

Periodic cleaning is the best way to keep your AB boat looking new, and performing as the day you bought it. Keeping an AB boat clean and in top shape could not be easier. To do so, please follow these steps after each use, and more often when used in salt water:

Open Tenders

1. Remove the outboard engine, seat and oars or paddles.
2. Inflate the boat up to working pressure.
3. If wet, leave it to dry, against a wall for example.
4. When dry, vacuum-clean or brush it in order to get any sand, gravel rubbish or debris off the floor.
5. If necessary remove all tar or sea particles with toluene.
6. Clean all over with ordinary soap and water and rinse thoroughly with fresh water.
7. Check the inflation valves, clean them and remove any sand or debris

Console Tenders

1. Clean as afore mentioned.
2. If you can lift the boat out of the water, remove both the condensation valve and the expanding drain plug. If not use your bilge pump.
3. Wash the hull and floor with mild detergent and fresh water.

Caution

Never spray any kind of greasy solution or solvent on the tubes, as this could contaminate the materials should repairs become necessary.

Caution

For cleaning the tube do not use products containing silicone as it can cause irreversible damage to the material.

Maintenance

Warning

Do not use abrasive cleaners, solvents, ammonia or chlorine as these will damage the gel coat surface. Under extreme conditions, special cleaners may be used to remove marine growth such as scum or algae, from the hull.

Use as few cleaning agents as possible; do not discharge waste agents into the water.

Fibreglass Care

Waxing the entire gel coat surface at least twice a season is recommended for all climates. Use of a specially formulated gel coat wax will prevent colour fade and soil and scum adhesion. If the gel coat has chalked or faded from lack of proper maintenance, buffing may be necessary to bring back the shiny appearance. Hand buffing with #7 rubbing compound or power buffing with glazing compound #1 will quickly restore the surface.

Aluminum Care

Wax the painted surfaces of the boat twice a season. You may use boat or automobile wax.

Aluminum Corrosion

Under certain conditions aluminum boats are subject to corrosion. There are different kinds of corrosion to happen, among others: galvanic, stray current and poulitce. All these types of corrosion result in metal being eaten away, and, if not stopped, can cause severe damage. Although these types of corrosion can occur in freshwater salt, brackish, polluted and high mineral content water will greatly accelerate corrosion.

There are various variables which foster corrosion as salinity of the water, temperature, organic material in the water, electrical activity nearby, presence of other metals, among others.

Corrosion is a common occurrence, but the deterioration process is usually slow with ample but subtle time to take corrective actions. Boaters should protect the boat against corrosion in the best feasible manner and be disciplined in looking for it.

Always watch for corrosion near bolt holes, chipped paint, behind peeling paint and any place the aluminum has been scratched or dented. Edges, cracks places that trap salt water and debris are more susceptible for corrosion.

Avoid buildup of organic material, plant growth, algae or barnacles.

For corrosion in general, routine cleaning and maintenance is the best hand you can give to your boat, especially in areas of difficult access such as the space between the tube and the hull, where different types of residues or organic material can cumulate and create an environment for corrosion.

Poulitce corrosion may occur when bare aluminum surfaces are covered by absorbent materials, dirt and debris trapping moisture against the unprotected metal surface. A way to prevent the poulitce corrosion is to repair scratches and dents as soon as they occur, also to coat all bare metal surfaces, but the most important, coated or not, you must keep the aluminum clean and dry.

Additionally, boats used in aforesaid water should be properly protected with antifouling paint or a similar protectant, but it is best to remove the boat from the water when not in use. It is important to consider that antifouling products must be suitable for aluminum. It must not be based on a dissimilar metal, copper is particularly problematic.

In some cases, it is also advisable to add extra zinc anodes securely attached with clean and tight connections. Never paint or coat zinc anodes and replace if they are eroded to 50% or more.

Isolate the hull from electrical current. Make sure your battery is grounded to your engine and do not ground electrical devices to the aluminum hull.

Except for sacrificial anodes, do not place any metal to the hull other than aluminum or high quality stainless steel. If you use fasteners they should be plastic or stainless, not zinc, brass, copper iron or any other metal. Inside the boat, do not let any metal sit in the same spot in the bilge for long time.

After you have cleaned the boat including the fibreglass hull, and it has dried completely, deflate it slightly, (the drain and condensation valves must remain unplugged), cover the boat with a canvas and store it on top of chocks, boat cradle or trailer under a roof/shade.

Notice

The hand pump can also deflate the boat by changing the connection from the inflation position to the deflation one.

Warning

When storing your inflatables, ensure protection against rodents and other vermin as they will feed on the fabric of the boat.

Fibreglass Hull Repair

Periodically you must inspect every square centimetre (inch) of the rigid hull of your inflatable. The best way to do it is by rubbing your hand over the surface. Generally, you will feel the scratches and chips before seeing them, more so when they do not extend right through the gel coat to the laminate underneath. Mark these areas with a waterproof felt pen for further inspection. When you see the same colour right through the scratch or chip, the gel coat has been damaged. In this case, simply lightly grind out the cavity with an emery disc in an electric drill or with emery paper used by hand, and fill up the hole with gel coat. To complete the job, you then grind the gel coat filling flush with the surrounding surfaces using a very fine emery disc and polish the whole area with an abrasive cleaner so that it blends in. Small chips and scratches of this type can be left in most cases without fear of the damage worsening because the gel coat still provides a seal against water entering the laminate. The touching up treatment suggested is only necessary if you are greatly concerned about the cosmetic appearance of your boat.

More serious are chips and scratches which extend into the laminate. These can usually be identified as a white surface under the gel coat with a fibrous texture. If the damage is minor with only the gel coat having been removed, then follow the same procedure as described above, but make sure that you grind back the gel coat to a point where there is positive adhesion between the gel coat and the laminate underneath.

For major fibreglass damages, please take your inflatable to an authorized service centre.

Aluminum Hull Repair

Due to the strength and durability of aluminum hulls, they tend to suffer a lot less. In case of dents, perforations, ruptures or fractures, please take your inflatable to an authorized service centre specialized in aluminium welding. If the aluminium hull has not received the proper care specified in the Maintenance chapter, it could be a victim of corrosion. Depending on the amount of corrosion, it could be repaired at the above mentioned centre.

Repair of the Tube

Your AB boat is supplied with a maintenance kit for patching minor punctures. This kit consists of several patches of (CSM) Coated Fabric material, sanding paper, glue and catalyst, which are exactly the same as those used for the manufacture of the boats.

If your boat has suffered a major accident, the repair should be completed by an authorized service centre in your area. Contact your closest AB dealer for assistance in finding this information.

If your boat is leaking, a test of five hours duration is sufficient to have a good estimate, but one should stabilise the pressure at 0.2 bar (3 psi) during the first half hour. Any change in temperature can cause modifications ranging from 0.003 bar (0.045 psi) per one degree Celsius (34°F). It is impractical to look for leaks which do not lower the pressure beyond 0.003 bar (0.045 psi) per hour.

Warning

Any important fall of pressure should immediately be checked carefully.

You must first determine exactly where the air is leaking from. Please follow these instructions:

1. Check that there is no sand or debris within the air valve.
2. Make sure that the valve gasket is in place.
3. Inflate the buoyancy chamber.
4. Close the cap on all the valves.
5. Rinse the boat with soapy water, including perimeter of the inflation valves.
6. Wherever bubbles appear, that is the location of the leak to be repaired.
7. Mark the area with a PENCIL, not a pen or a marker, as they will stain the tissue.
8. If your leak is located in the buoyancy chamber, please read Repairing a Perforation or Rupture.

9. If the bubbles appeared around the inflation valves, then your valves are loose.

10. The valves are a nut and bolt system: With the tube deflated, hold the back of the valve through the fabric and tighten the front. You may tighten the front either by hand or you may insert the points of a pliers and turn clockwise. USE MODERATE STRENGTH.



INFLATION VALVE

11. If no bubbles appeared either on the fabric or around the valve when the buoyancy chamber was inflated, cover the CLOSED cap of the valve with soapy water. If bubbles appear then the valve must be changed.

12. With the buoyancy chamber deflated, unscrew the front of the valve and replace it with a new one.

13. If none of the above applies, please contact your closest AB dealer.

Repairing a perforation or rupture

Repairs should be carried out on deflated or partially deflated boats.

Repairing a detached accessory

Repairs should be carried out on completely inflated boats.

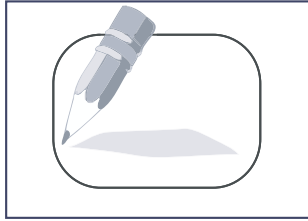

1. Clean the surface to be repaired. It must be free of dust or any kind of grease.
2. Select a patch of tissue at least 5 cms (2 inches) larger than the tear.
3. Place the patch over the damaged area, and contour it with a pencil, NOT a pen or marker, as they will stain the tissue.
4. Put masking tape all around the pencil mark. The area where the patch is going to be set must remain free of tape.
5. Very carefully with the piece of sandpaper #80 supplied, sand the tissue. The (CSM) Coated Fabric covering the damaged area must be removed. When a rough or uneven surface appears, you have completed the sanding. It is advisable not to buff distractedly as you may reach the polyester weft. Buff likewise the (CSM) Coated Fabric patch.
6. If repairing a detached accessory remove the old glue by buffing.
7. When both surfaces have been buffed you must remove all dust from the area. You may want to use a solvent to clean the sanded area. Once you have cleaned the rubber, DO NOT touch it with your fingers because you will transmit grease to the surface, and the adhesive will not stick in these areas.
8. Prepare the glue in the following manner: 9 parts of glue + 1 part of catalyst. Mix both ingredients in a clean and dry glass or metal container using a clean metal or wooden stick.
9. Apply with a brush to BOTH surfaces, one coat of glue, as thin as possible and making sure it's spread evenly. Leave it to dry for 15 minutes before applying the second coat. Once the first coat has become tacky, apply a second coat of glue to both parts. Let dry once again for 15 minutes.

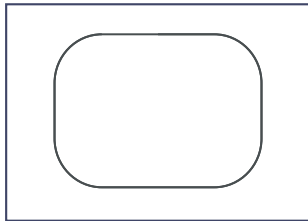
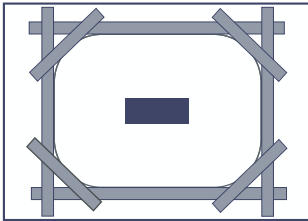

Note: In humid, wet or cold weather the glue may dry slowly, and may remain wet/humid. It may be necessary to use an electric hair dryer until the glue dries to tacky state.

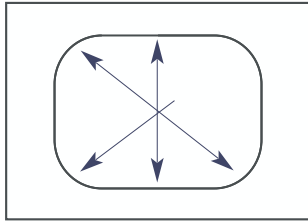
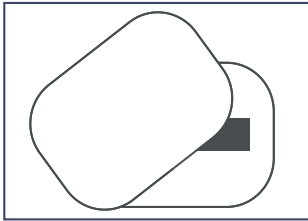

10. When the last 15 mins. have elapsed, put the two parts together. Start by affixing one side of the patch, and move slowly to the other side by pressing the surfaces together. This will press the air bubbles out.
11. Take the but of a screwdriver and press it over the already glued together patch or accessory, always from the centre outwards so as to press out any trapped air bubbles. Once glued together remove the masking tape.
12. Let the repair dry during 24 hours.

Slight Ungluings

Slight ungluings will be treated the same way as described above. Widen slightly the unglued parts, buff and glue, as instructed.

Large Tears

For large tears please take your inflatable to an authorized service centre.

Your AB inflatable boat can be used in many ways and can give you endless satisfaction. Nevertheless, its maintenance and its performance depend on a number of factors that are important to you, the owner, and which are respectively:

1. Correct & Balanced Inflation: Properly balanced inflation is the principal factor controlling the correct operation of the boat. It is important to know that:

- a.** The buoyancy chamber should be inflated to a pressure of about 0.2 bar (3 psi).
- b.** The inflation varies with the temperature: one degree more or less will cause the pressure to vary by about 0.003 bar (0.045 psi). This pressure variation takes place as a result of temperature changes, without the air tightness of the buoyancy chambers being at fault. Furthermore, the pressure will drop when the boat is launched. It is therefore advisable to reinstate the correct pressure with the hand pump after the boat has been launched or after it has been used for a few minutes.

2. Load Distribution: As a general rule, the load of a boat should be distributed along the centre line and rather towards the rear of the boat. Remember this in connection with fuel tanks, diving bottles and other heavy items.

Small items and light equipment will normally be stowed towards the aft. In the case of a rigid hull inflatable, within the bow hatch.

Water skis or spearguns should be placed against the buoyancy chambers or fixed to them. Once again if your inflatable is a R.I.B. then stow these items in any of the compartments designed for storage. Remember to protect the material from sharp objects, roughness or rubbing (sand is an excellent abrasive).

In heavy seas and brisk winds the load should be moved forward. In calm waters the load should be moved further aft.

With certain loads and with certain types of engines the boat may remain bow high. This is a result of a critical speed of the outboard engine which should be overcome by accelerating smoothly and evenly in order to avoid excessive strain on the stringers and the transom. The driver and/or passenger may also move forward, in order to get the boat on plane, then return to their original seating position. Once the boat is planing, the speed can be reduced slowly.

Use & Performance

Beware of overloading in the bow of the boat which will result in loss of speed. In rough weather a slight overloading at the bow will ease the motion of the craft.

Please check the load capacity of your inflatable either on the capacity plate located on the transom of your boat or on page or turn to the chapter on Specifications.

3. Outboard Engine Powering (Maximum): It is your responsibility to decide on the proposed use of the boat before selecting the size of the outboard for your AB. Whilst it is admitted that it may be necessary to install an outboard motor of a particular horse power in order to retain manoeuvrability under bad sea conditions, it is dangerous to install an engine with horse power exceeding the recommended limits. For more details on recommended and maximum horsepower, please turn to chapter on Specifications.

The boat will become unnecessarily fatigued by the weight of an outboard engine larger than recommended resulting in excessive vibration, without the performance improving measurably.

We would therefore make the following recommendations with regard to the use of an outboard engine with your AB:

- a. Always read the engine owners' manual carefully before installing and/or operating.
- b. In the case of the smaller dinghies: The clamps securing your outboard engine should be thoroughly tightened by hand. This clamping must be checked after 15 mins. underway.
- c. The motor should be in the centre of the boat that is to say in the middle of the transom.
- d. So as to prevent an accident and the loss of the engine, should it fall off the transom, attach an engine securing line (cable or rope) connecting the engine to the boat. You may use an existing stern eye or lifting ring as an attachment point near the stern.
- e. Before tilting your motor, or before drawing the boat out of the water, disconnect the fuel line and allow the engine to run until the carburettor is dry, so that when the engine is tilted no fuel is discharged into the boat.

Caution

Respect the percentage of oil in the fuel.

Warning

- Using an outboard engine that exceeds the maximum HP recommended is dangerous, may cause vibration, impede performance and void your boat's warranty.
- Be sure you have enough fuel for your boating trip.

Danger

Fill the portable tank outside the craft, in a well ventilated area, away from any risk of ignition.

4. Proper Adjustment of the Outboard Engine:

a. The adjustment of the angle of the outboard motor in relation to the transom is vital in order to ensure the correct performance of your boat.

As a general rule, the axis of your propeller should be parallel to the surface of the water when the boat is on plane.

If the outboard engine is too far away from the transom, the boat will tend to depress the stern when you start off.

If the motor is too close to the transom, the boat will have a tendency to ride nose down.

This adjustment can vary for the same outboard motor depending on the weight and position of the load and the condition of the sea. In order to use the boat under normal conditions, place the regulation index of the outboard motor on the 1st hole from the transom.

b. The height of the outboard engine will equally affect the performance of the boat in the following aspects:

- Water thrown up in the form of spray behind the transom.

Use & Performance

- Alteration of the centre of thrust.
- Speed.

Most outboard motors can be mounted directly onto the transom engine mounting plate. When used for certain purposes (speed, heavy loads, etc.) a wooden batten of a thickness of between 0.5cms and 2cms(3/16" and 7/8") may be placed on top of the transom in order to raise the engine in relation to the transom.

There are many adjustments that may be made to the outboard engines and you will discover the best position for your outboard engine as a result of trials. For more information consult your marine dealer and the engine operator's manual.

Notice

- An outboard engine which is installed too high will tend to cavitate, especially on sharp turns, and will run the risk of exceeding its normal operating conditions.
- An outboard engine which is installed too low may cause the water to enter over the transom between the clamps.

Operation

Before starting:

1. Check the pressure in the buoyancy chambers 0.2 bar (3 psi).
2. Secure the valve caps.
3. Check that the oars/paddles are properly secured.
4. Ensure that the outboard engine clamps are properly tightened.
5. Check that the fuel lines, vent hoses and drain hoses are in good condition.
6. Be sure you have enough fuel for your boating trip.
7. Do not forget the boat's papers and your licence.
8. Do not forget the required equipment at sea.
9. You may require your tool kit, repair kit and air pump; make sure that you have them with you.
10. Avoid making noise and wake in the vicinity of other users, and respect the

speed limitations.

11. Please check the chapter on Marine Safety and with your local authorities on the safety requirements you must comply with.

Boater's Check List

FOR MAXIMUM ENJOYMENT AND SAFETY, CHECK EACH OF THESE ITEMS

Check before you launch your boat

- Read and understand the owner's manual.
- Drain Plug (Securely in place).
- Propeller conditions (prop nut tight and secure, not cracked or bent blades).
- Steering System (Working smoothly and properly? Self locking nut in place).
- Battery (Fully Charged, Cable terminal clean and tight).
- Capacity Plate (Are you overpowered).
- Weather conditions (Safe to go out?).
- Fuel System & Oil (adequate fuel? Leaks? Fumes? Sufficient for trip, check bilge area for odor).
- Hoses and connectors (no leaks or damage).
- Electrical equipment (Light, bilge, pumps?).
- Emergency Gear/Safety Equipment (fire extinguisher, bailer, paddle, anchor & line, signaling device, tool kit, mooring lines, first aid kit and manual).
- Float Plan.

Check before you start your engine

- Fuel (sufficient for trip; check bilge area for odor).
- Engine (control in Neutral?).
- Capacity Plate (Are you overloaded).
- Life-Saving Devices (One for every person on board).
- Seating (Everyone in proper place).
- No One in water near boat.
- Lanyard stop switch (operational and securely fastened).
- Keep a firm and continuous grip on the steering wheel.

Towing your Inflatable

Depending on the model you have purchased, it will be outfitted with lateral tube towing rings. Please refer to the chapter on Specifications for more information.

Notice

You should only tow your tender for short distances.

Models 8 - 10

There are a few different ways to tow your inflatable boat. The following description is AB recommendation. All Ribs should be towed by the bow eye (U-bolt). Depending on the model you have purchased, it will be also outfitted with lateral tube rings. Lateral tube towing rings are used to help maintain a stable direction of the boat while being towed. Depending on the performance of your boat while being towed you may or may not use the lateral tube towing rings. The performance of the boat will vary depending on the speed, sea conditions, wind and the distance between boats. Leave at least 2 boat lengths between the boats for adequate movement. The exact distance depends upon the vessel being towed and should be determined by experience. Adjust the length of the bow line to match the wave action. Attach a second line to the towed boat's bow eye (U-bolt) and tie it separately to the main vessel. This provides additional security should one line break.

Warning

- Never tow a boat with people on board.
- Towing or being towed stresses the boats, hardware and lines. Failure of any part can seriously injure people or damage the boats.
- Never use three-stand twisted nylon; it has too much elasticity and can snap back dangerously. Because of the tremendous stress caused by towing, use a tow line that is rated at least 4 times the gross weight of the boat being towed.

Caution

- Do not attach the towing line to the bow grab handle or any other accessory not designed for that purpose.
- Tow ropes must always be in good condition, free of any cuts or abrasions.
- When attaching the towline to a fitting, be sure the fitting is fastened securely and through-bolted.
- The (CSM) Coated Fabric handles must not be used for towing.
- Keep the towing boat and the inflatable tender on the crest or in the trough of the waves at the same time. In protected, calm waters, shorten the line for better handling.
- Never attempt to tow a much larger or grounded vessel.
- Always tow at moderate speed so as to prevent sudden strain on a slack line.
- Keep lines all clear of propellers.
- Keep hands and feet clear of the other boat.
- Never hold a towline after it is pulled taut.
- The boat structure can be damaged by excessive pulling strain.
- Be ready to cast loose or cut the line if the towing situation becomes hazardous.

Danger

Do not allow anyone to be in line with the tow rope. If the rope should break or pull free, a dangerous recoil could occur which may cause serious injury or death.

Davit Lifting

All AB boats have davit lifting rings installed from factory, except the larger models. Depending on the model it will come standard with three (3) or four (4) davit lifting rings.

For more detailed information, please visit www.abinflatables.com.

Depending on the davits installed on the main vessel, you may lift your tender in two different ways: single point or dual point. Please see diagram.

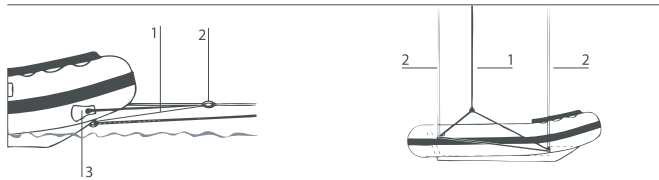

TOWING

1. ADDITIONAL TOW LINE FOR BACKUP.
2. TOWING LINE WITH BRIDLE.
3. TUBE TOWING RINGS.

DAVIT LIFTING

1. SINGLE POINT DAVIT LIFTING
2. DUAL POINT DAVIT LIFTING

Notice

Always pump the water from the bilge before lifting the boat.

Caution

Do not hoist the boat with people on board. Lifting attachments are designed for hoisting the boat, engine and standard equipment only.

Warning

- Keep the bow slightly higher than the stern. Remove the drain plugs when stowing the boat.
- Never attach lifting cables to grab handles, lifelines, cleats or any other accessory not intended for lifting purposes. Attach only to the lifting rings in the transom and bow.

Transporting by Road

Depending on the model you have chosen, you have two (2) alternatives to transport your inflatable:

1. Carry the boat, upside-down, on the roof of the car, for boats under 4 metres (13 feet).

2. Carry the boat on a trailer.

1. Carrying the boat directly on top of the roof of your car: There will inevitably be a degree of movement between the boat and the car roof, which can lead to damage. The car's roof must be in proportion to the length of the boat being carried. A special roof rack is the best solution in avoiding any damage. Stow the boat upside-down on the roof where its shape will tend to offer less wind resistance. If carried the right way up there is always a risk of the boat collecting water if it rains. Always leave the drain plug out.

Warning

- Beware of chafing. If any lines securing the boat to the car roof or rack rub against the tube, insert a piece of carpeting (soft side against the tube) so as to avoid damage.
- Beware of chafing, when deflated. Do not transport your inflatable upside-down.

Caution

When transporting an inflatable on the roof, we recommend a stop every hour to check the security of the boat and its lashings.

2. Transporting your inflatable on a trailer: There are several types of trailers available, however the trailer must match the boat's weight, the hull and the load. The towing vehicle must have the capability of pulling the load. Pulling a load that exceeds the vehicle's towing capacity may cause loss of control.

- When choosing your trailer consult your marine dealer.
- Always read the trailer's owner's manual carefully before towing.
- Check country, state or local regulations and requirements.

- General Description
- Standard Equipment
- Electrical System Operation
- Color Code
- Maintenance
- FAQs
- Recommendations

General Description

Read the recommendations below, before launching your boat. Be sure to understand the information given in this manual, any improper operation could jeopardize the operation of the equipment in your boat.

The following equipment description includes only the elements which are installed at the factory as standard equipment. For any additional information please contact your local dealer.

Each system and its equipment were carefully selected and designed so that it meets with the requirements set by the ABYC and ISO standards. Also, this equipment is certified for marine use, which guarantees durability under the conditions of humidity and salinity of marine environment.

Console boats as DLXs and VSTs are delivered with a basic electrical installation that includes some or all of the following elements:

- Bilge Pump 500/750 GPH
- Navigation Lights
- Position Light
- Master/Battery Switch
- Fresh Water Pump
- Blower
- Battery Box

- Battery Charger
- Fiber Carbon Switch Board
- Mechanical/ Hydraulic Steering System
- Steering Wheel

Standard Equipment

Bilge Pump BILGE PUMP Switch

The bilge pump is installed on a base located in the stern box. The function of this device is to evacuate the water that accumulates on the boat because of waves or rain. The bilge pump has a dual operation start system, both automatic and manual. The pump has the possibility of a remote start by using the manual switch "BILGE PUMP" installed on the switch board located on the console. To protect your boat from the weather conditions, this equipment will work even when the "BILGE PUMP" switch is turned off; it is possible because the pump is connected directly to the battery. Thus, the automatic floating system will work even if the user is not there to assist the evacuation of water.

Bilge Pump Technical Features

Model	S500	S750
Amp	1.5	3.0
Fuse (A)	3A	5A
GPH/Oft	500	750

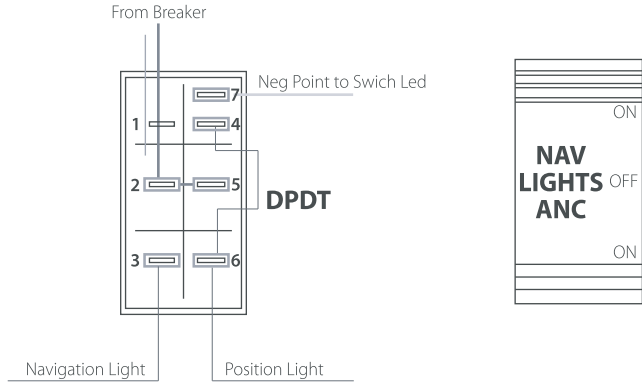
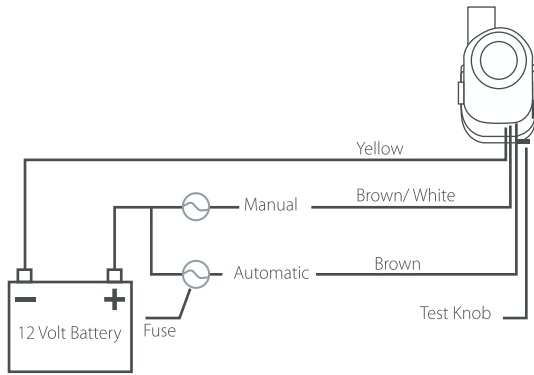

Notice

See the Bilge Pump Installation Instructions attached in your owner manual package.

Navigation and Anchor Light

NAV/LIGHT/ ANC Switch

The standard equipment on all models includes the anchor light (white) and the navigation light (red / green) which work with the NAV/LIGHT/ ANC Switch located on the console switchboard. These lights should be turned on during the operation of the boat at night. When the boat is moving, the boater should turn on both navigation and anchor light; this is done by pressing the switch to the up position. When the boat is anchored, the boater should only turn on the position light; this is done by pressing the switch to the low position. Both lights will be off in the central switch position.

Master /Battery Switch

ON/OFF 300A

The battery switch is the main ignition control unit for the energy on the boat. Through this equipment is done the energy electric transfer from the battery to the load equipment. When Battery switch is placed in the OFF position, any device except the bilge pump can be energized. The motor, indicators, lights, water pump and other equipment may not be on. You should use this equipment in fire situation emergencies, to cut off the power supply when an overcurrent event happens. To prevent battery discharge, while the boat is not in use, turn OFF the main switch.

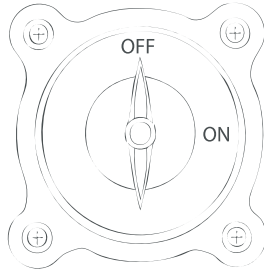

Fresh Water Pump FRESH WATER Switch

Models 14-19 DLX and 19-28 VST are equipped with a permanent freshwater tank. AB provides as standard equipment a freshwater electric pump and recessed shower for the use of the water stored in these tanks. This water can be used as a shower or just to clean up your boat. This system is not suitable for running potable water, drinking of this water may cause illness.

The pump has an automatic pressure switch that enables the user to cut off or allow the water flow by pressing the button on the recessed shower. When the "FRESH WATER" switch is placed in the ON position, the pump will start if the shower button has been pressed. If the user releases the button when the water is coming out, the pump will shut off and the water flow will stop, even if the "FRESH WATER" switch is set to ON. This way you can control the activation of the pump not only by the switch ON/OFF action, but also by pressing or releasing the shower button.

Blower

BLOWER Switch (19 DLX I/O)

The blower (exhaust fan) is an exclusive standard feature on the 19 DLX I / O model. This equipment is installed to draw out the combustion gases that accumulate in the engine compartment. This device must be activated prior to starting the engine, in order to avoid accumulation of gases.

 WARNING	
Gasoline vapors can explode, resulting in injury or death.	
Before starting engine	
• Check engine compartment bilge for gasoline or vapors, and	
• Operate blower for four minutes, and	
• Verify blower when operation.	
Run blower when boat is operating below cruising speed.	

Battery Charger

The battery charger in AB models is an auxiliary load saver device for the batteries. If the use frequency of your boat is low, after a while, the battery might not have enough power to start the engine. Use the charger to provide and / or maintain the load in the battery for the requirements of the starter motor.

Caution

Be aware on the following specifications for this equipment related to input and output voltage.

Input: 115 VAC 60HZ, 1 Amp full load
Charging: 12 VDC 2 Amp
Maintenance: 13 VDC at 0.1 Amp

For further information and/or questions, please refer to the battery charger manual attached to the owner package in the boat.

Connect the battery charger input to a good condition electrical outlet and follow the instructions given in the warning label placed next to the exterior connect charger inlet device.

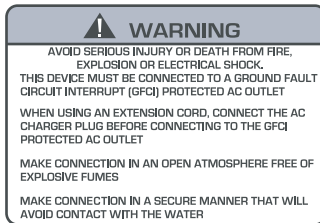

Notice

See the battery Charger operation manual attached in your owner manuals package.

Steering System

Your AB boat is equipped with mechanical or hydraulics steering systems of the highest quality standards.

Notice

Refer to the attached manual for steering system devices and parts to resolve any questions about installation and / or performance.

Electrical System Operation

Your AB boat has been equipped with a 12-volt direct current electrical system. The positive red large gauge cable is connected between the (+) battery terminal and the main switch. The negative yellow large gauge wire is connected to a common post ground where all negative wires of the boat device are connected. To start your engine turn ON the main switch.

When your boat is in operation, the battery will be permanently feeded by the engine alternator.

Caution

Do not place the battery switch into the off position, while the engine is running.

Breakers and Fuses

Each electrical circuit has been designed to meet the standards set in ABYC.E-11. AB has made emphasis in the selection and rated of the circuit protection and automatic cutting device.

Breakers

Each one of the circuits that feeds a certain load is protected by an automatic breaker usually placed at the fiber carbon switch board on the console, above the switches of the circuits it protects. If an overcurrent event happens, the breaker opens the circuit and avoids damage to the wires.

Fuses

Fuses are installed on the AB models to protect the general circuits (Panel feed wire/circuit). When an overall damage occurs, the fuse will burn out protecting the circuit. After finding and fixing the electrical damage the owner should replace the fuse with a new one of the same rating.

Notice

See the troubleshooting chart.

Additional Circuits

ACC Switches

Each AB rigged boat is delivered with additional circuits for accessories. These circuits have been rated with an over current protection of 5 amps, so please consider this information when you select the additional devices to install.

Accessory Switch Connections

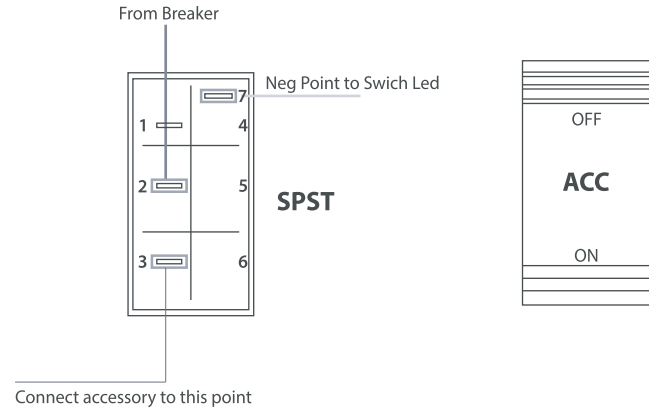

Instruments

Fuel Level Gauge

The fuel gauge measures the quantity of stored fuel on the tank. It operates through an internal floating in the tank.



Color Code

Maintenance

Wire color selection is based on the ABYC standard E-11 Table XIV and XV.

Description/ Device	Color
Ground Wire	Green
Positive Conductors	Red
Negative Conductors	Yellow
Bilge/Fresh Water/Pumps	Brown
Ignition Wire	Purple
Fuel Level Sender	Pink
Instruments Lights	Blue
Navigation and Position Lights	Gray

Despite having an excellent equipment line, the moisture and saltiness permanently present on marine environment can affect in long- term the components and cause failures if they don't receive proper maintenance.

- Regularly review the status of fuel hose connections to ensure there are no leaks.
- Perform regular maintenance for electrical equipment.
- Seek an electrical marine technician in case of repairs.

Frequently Asked Questions

Recommendations

Troubleshooting Chart

1. If the lights do not get on.

- Check the battery connection.
- Make sure the battery switch is placed in the ON position.
- Check the connections in the "NAV / LIGHTS / ANC" switch.
- Make sure the bulbs are in good condition.
- Check that the fuses have not been burned.

2. The bilge pump does not work in automatic mode.

The turn of the floating level, allows the bilge pump to work on the automatic mode. Sometimes because of poor maintenance, sediment or debris can accumulate blocking the float switch or the impeller. Remove the pump housing from the mounting base and clean the float switch and impeller so that it can have free movement.

3. No device turns on even when the battery switch is in the ON position.

This might be because the main fuse, placed on the control panel, has burned. Check the fuses in the fuse holder. If necessary replace it with the same capacity as indicated on it.

- If possible do not hold on all the electrical devices simultaneously for long.
- Disconnect the battery when the boat is been transported by road (trailer) and make sure to remove the drain plug.
- Always keep in, your maintenance kit and spare fuses.
- Remember to turn OFF the battery switch, whenever the boat won't be used for a long time. This will prevent a battery load loss if an electrical device is left on accidentally.

Caution

Never:

- Work on the electrical installation while the system is energized;
- Modify the craft's electrical system or relevant drawings: installation, alterations and maintenance should be performed by a competent marine electrical technician;
- Alter or modify the rated current amperage of over current protective devices;
- Install or replace electrical appliances or devices with components exceeding the rated current amperage of the circuit;
- Leave the craft unattended with the electrical system energized, except automatic bilge-pump, fire protection and alarm circuits.

Warning labels (For USA costumers only)

For aid in replacement of lost or illegible labels.

For all models you need the following labels:

- CO Helm Label (NW 204)
- CO Transom label (NW 206)
- Prop Helm Label (NW 207)
- Prop Transom Label (NW 208)

These labels can be purchased on the NMMA online store.

Additionally for models Oceanus and Nautilus you need the following labels:

- EPA EVAP LABEL
- Warning for leaking fuel

For Nautilus models you also need a Warning label for the use of the Battery charger.

For the Nautilus 19 DLX I/O you need a Warning label that indicates to run the Blower.

For the replacement of all the Labels you must follow the next indications for the Lettering and colors.

COLOR - SIGNAL WORD PANEL

The color has to be:

DANGER - black or white letters on a red background .

NOTE: Black letters on a red background for exterior applications, where the label is exposed to sunlight or red (night) light.

WARNING - black or white letters on an orange background.

NOTE: Black letters on an orange background for exterior applications, where the label is exposed to sunlight or red (night) light.

CAUTION - black letters on a yellow background.

- The minimum height of letters in the message panel has to be of 1/8" or 3.22 mm to have a visibility of the text from 5 ft. or 1,5 meters or less.

- The Signal word letters should be at least 1.5 times as high as the upper case letters in the message panel.

Following you can find the Labels:

CO Helm Label (NW 204)

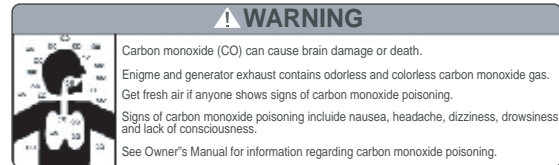

CO Transom label (NW 206)

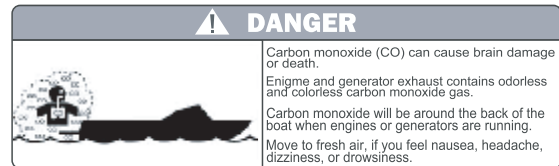

Prop Helm Label (NW 207)

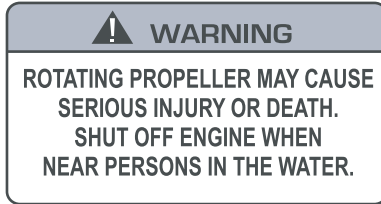

Warning for leaking fuel

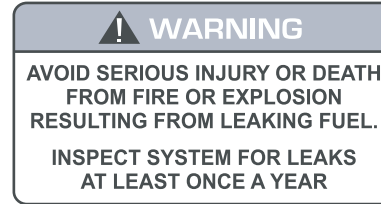

Prop Transom Label (NW 208)

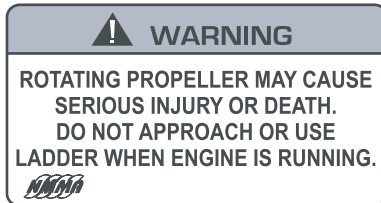

EPA EVAP LABEL



Blower

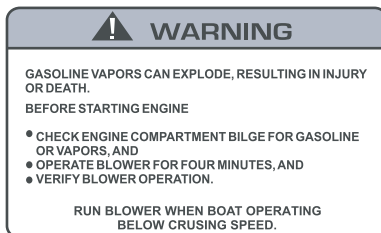

Battery charger

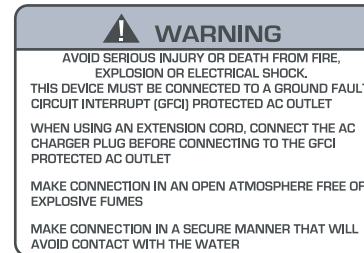

Electrical Diagrams

<https://www.boat-manuals.com/>

Please refer to these electrical diagrams when you want to make modifications repairs or maintenance in the electrical power system of the boat. Electrical systems are similar for groups of models presented below:

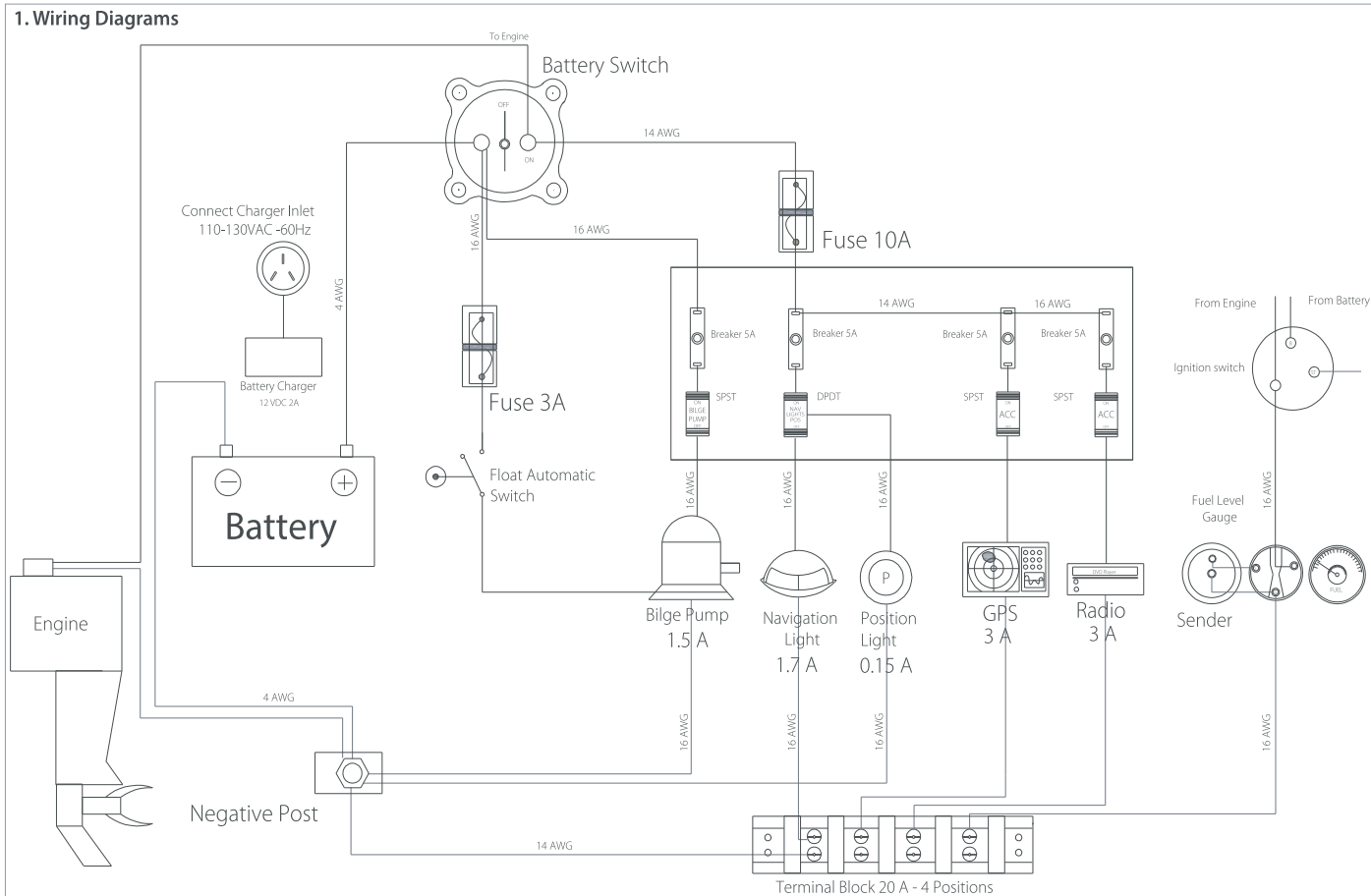

2. General Arrangement

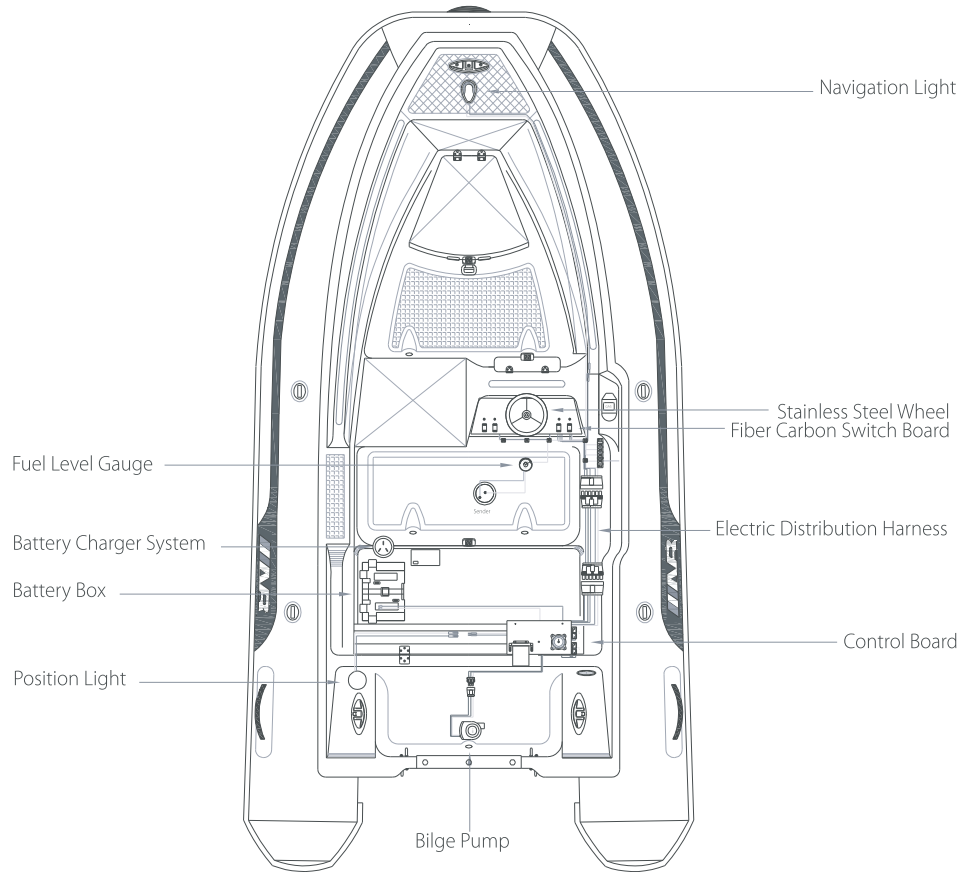

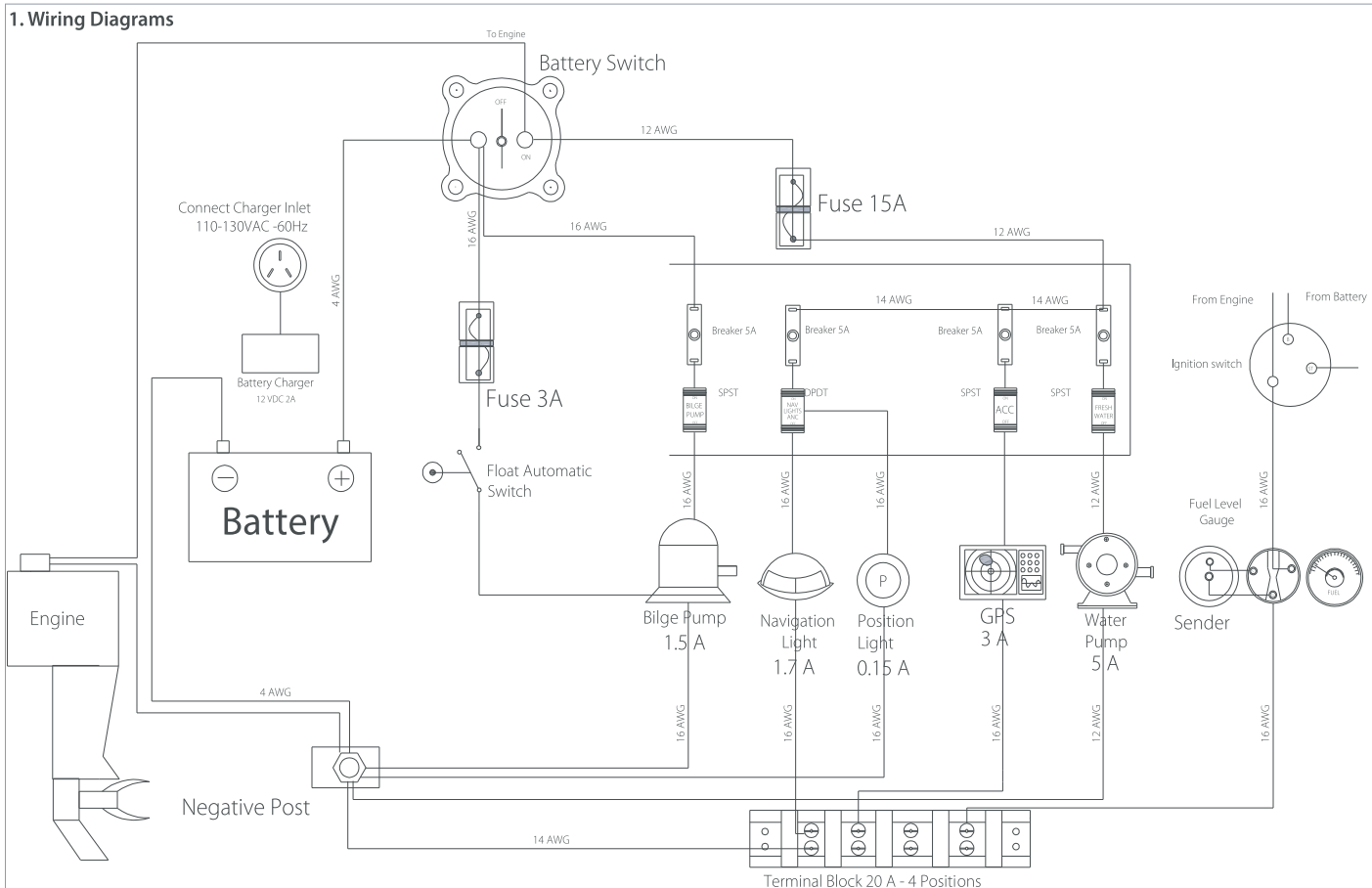

1. Wiring Diagrams

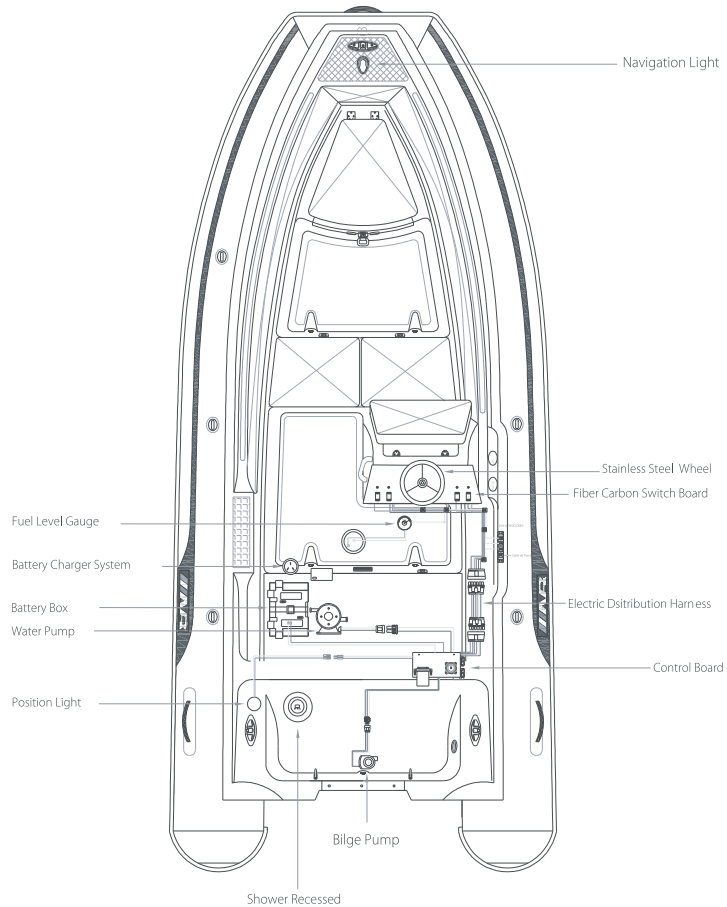

Electrical Installations 17-19 DLX

1. Wiring Diagrams

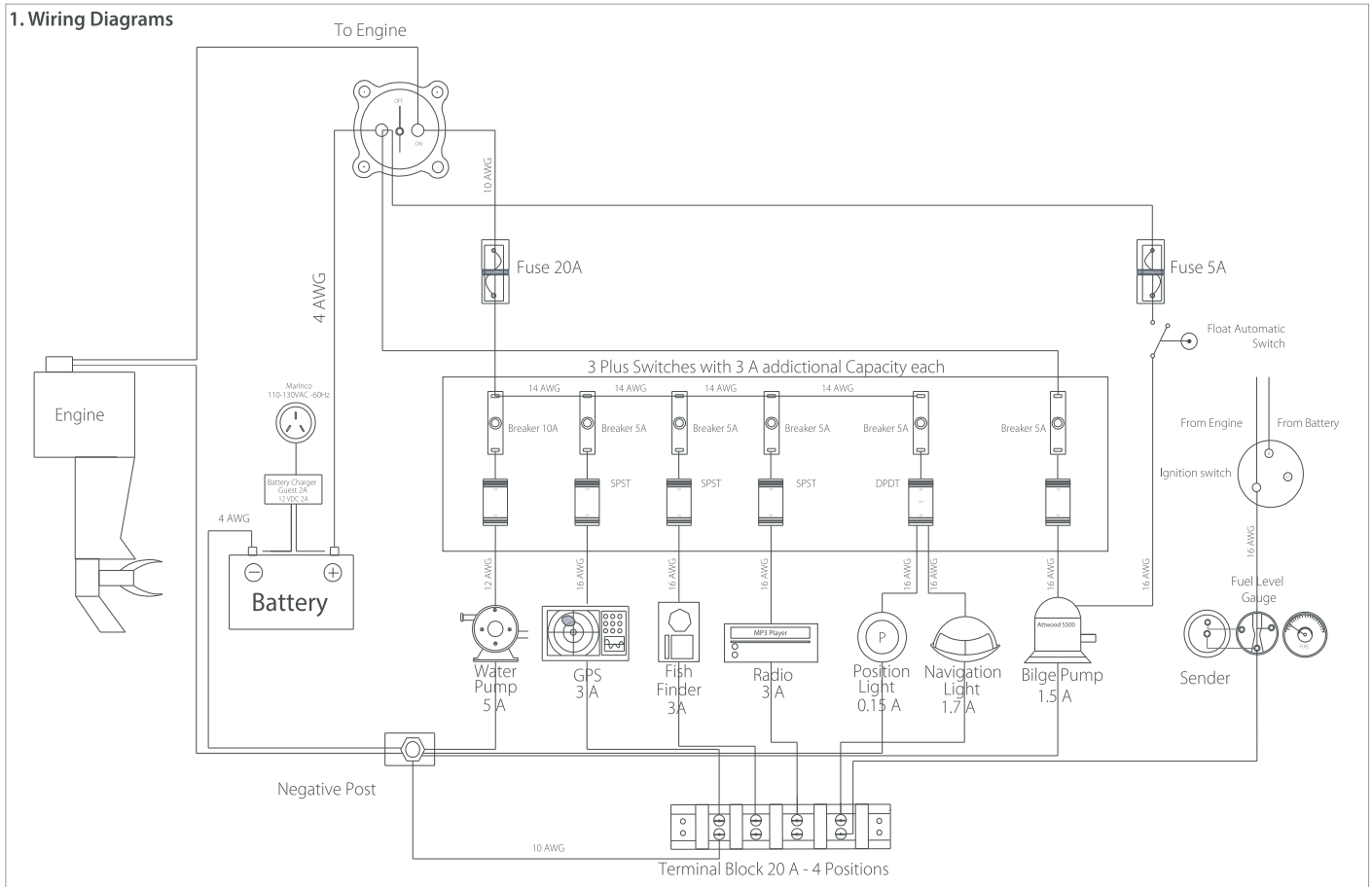

2. General Arrangement

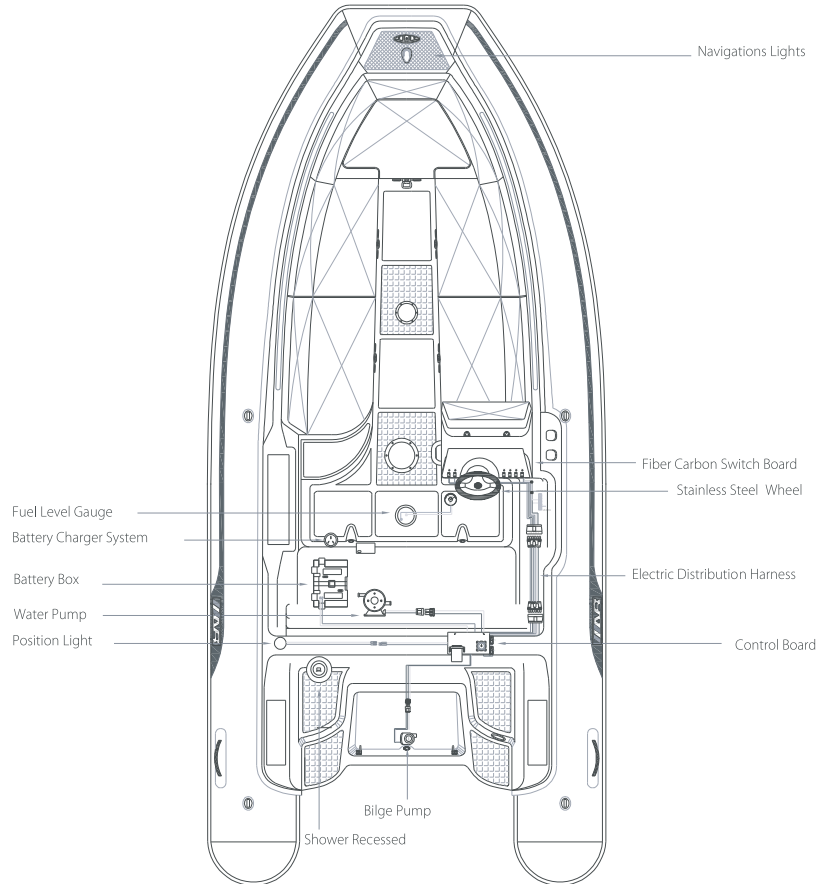

Electrical Installations 11-15 VST

1. Wiring Diagrams

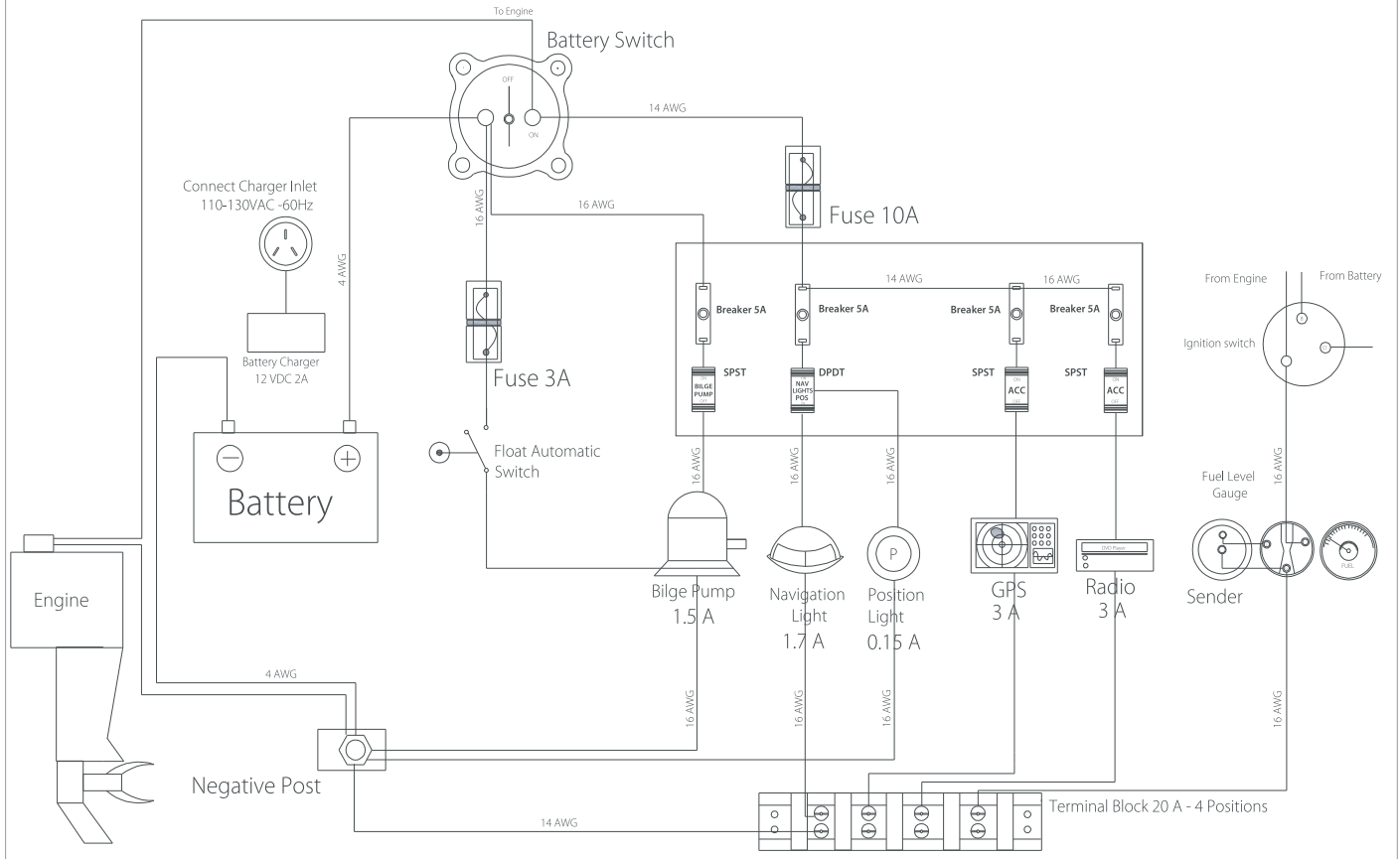

2. General Arrangement

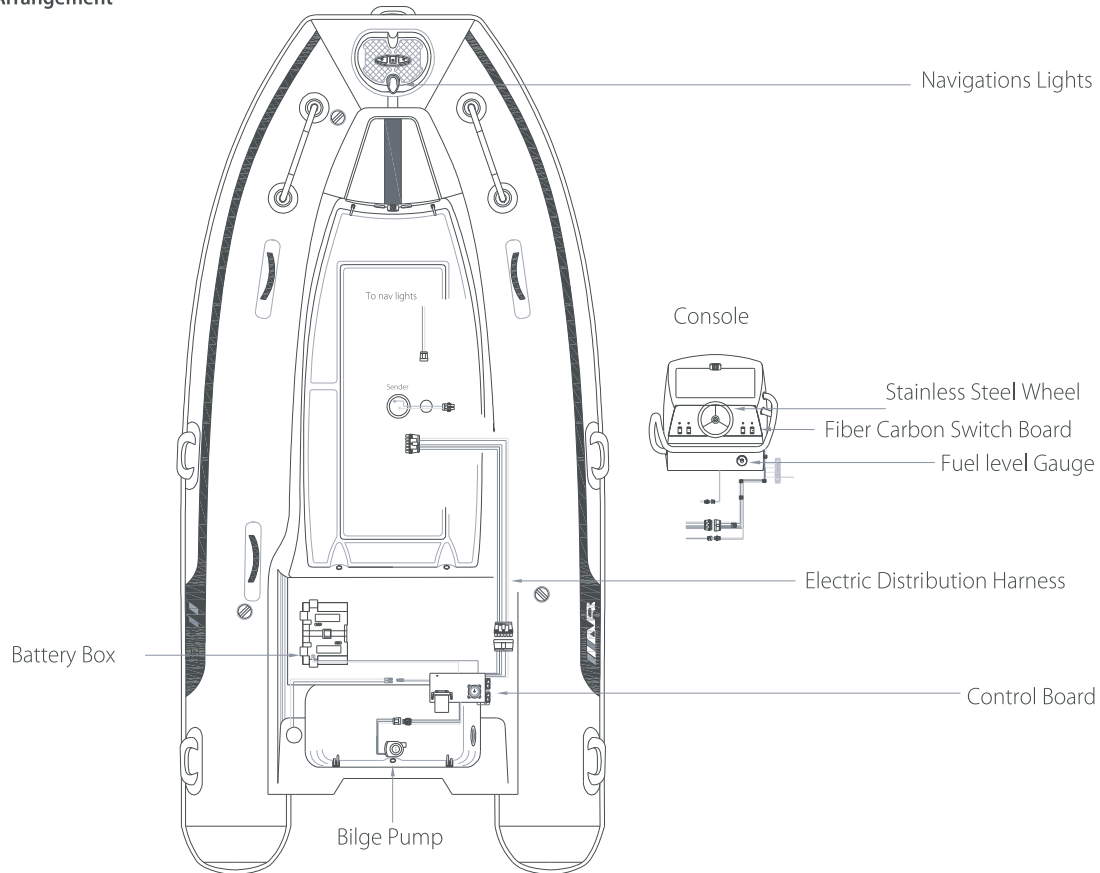

Electrical Installations 19-28 VST

1. Wiring Diagrams

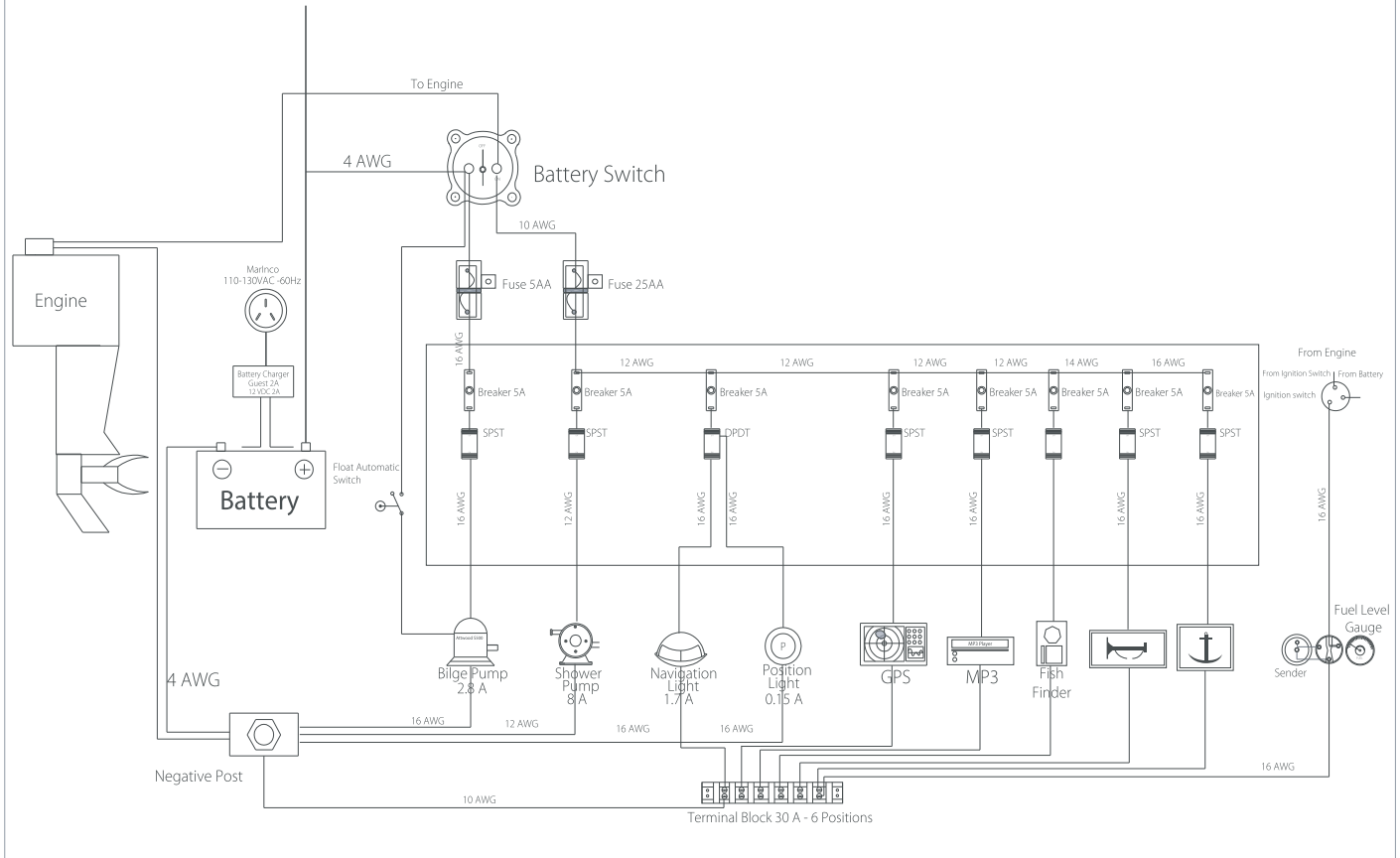

2. General Arrangement

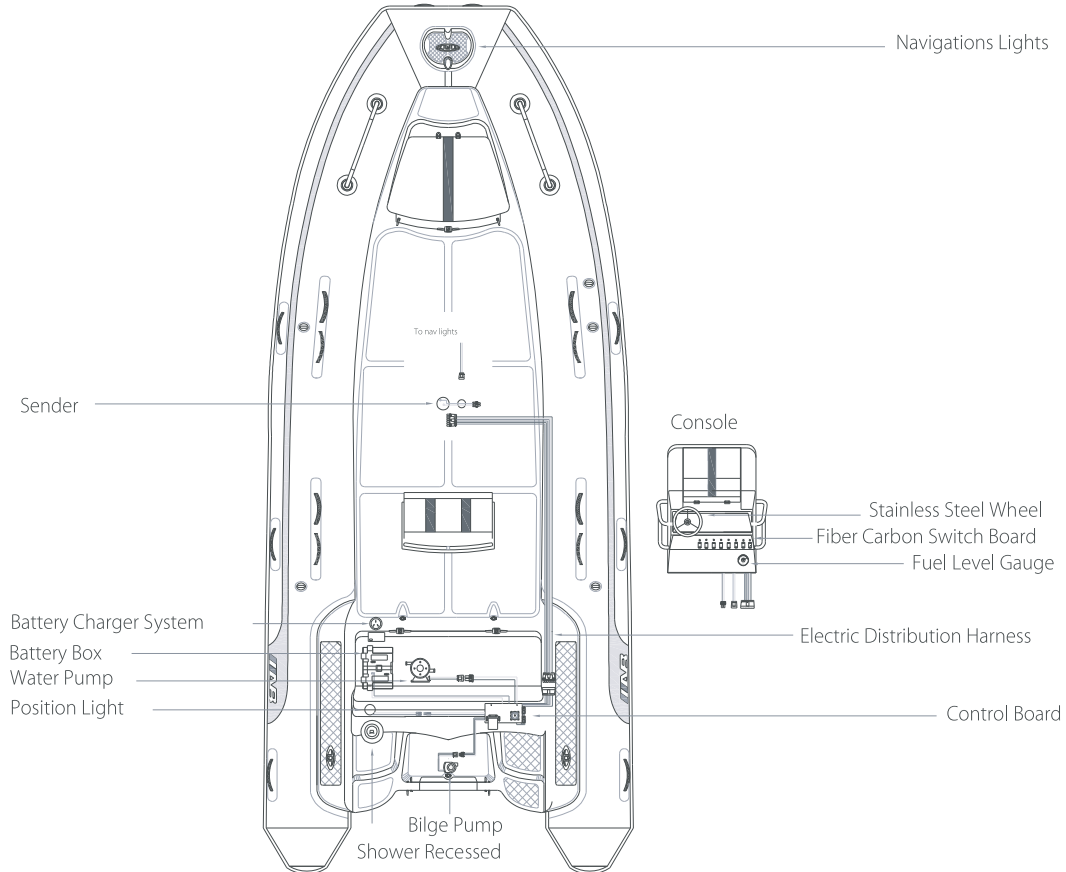

Problem	Possible Reasons	Possible Solution(s)
Buoyancy chamber loses air	Rise or drop of temperature	p. 11
	Plastic valve cap has not been fitted	p. 10
	Loose valve	p. 18
	Puncture	p. 19
Boat does not get on plane	Engine is incorrectly mounted	p. 21
	Load is not distributed correctly	p. 20
	Boat is overloaded	p. 20
	Hull is full of water	p. 14
Oar slips out of the base	Oar has been installed incorrectly	p. 13

Seating Arrangements

Please find all the information of the Seating Arrangements, in the Owner's Manual section at our webpage: www.abinflatables.com.

AB Limited Warranty

10. Year Limited Warranty (For models 2013 and up)

1. What is Covered – The DISTRIBUTOR warrants to the original purchaser of a properly registered AB inflatable boat that:

Every registered AB inflatable boat and its parts and accessories is warranted by the AB DISTRIBUTOR under conditions of normal purchase as specified and limited below, with respect to items as follows from the date of origin purchase:

The Chlorosulfonated Polyethylene (CSM) coated fabric of the tubes is warranted for a period of ten (10) years against porosity deterioration affecting serviceability. This warranty does not include discoloration, puncture, fading, tearing, ripping, cracking, abrasion, chaffing, negligence, accident or ordinary wear and tear. AB will repair or replace at no charge during year through 5. During years 6 to 10, if it is determined that the fabric is defective and in the event of replacement of inflatable tube, it will be offered at the following discount from the current manufacturer's suggested retail price for the molds:

- 50% discount in year 6
- 40% discount in year 7
- 30% discount in year 8
- 20% discount in year 9
- 10% discount in year 10

Warranty

B. Valves: The inflation valves are warranted for five years against defects in materials and workmanship. This warranty does not include ordinary wear and tear, negligence, or damage by improper inflation techniques.

C. Seams: The air holding seams of the inflatable tube are warranted for five (5) years against separation and subsequent loss of air, which exceeds twenty percent (20%) of recommended inflation pressure when measured over a period of five (5) days, while maintaining the boat at a constant temperature in a controlled environment. The major cause of damage is the result of running the boat underinflated. The owner is expected to check and properly maintain the correct inflation pressure before using the boat, or when temperature variations have exceeded ten degrees Celsius (10°C) or fifty degrees Fahrenheit (50°F) since inflation, or when running under unusual operation conditions.

D. Fiberglass hull: The composite of fiberglass hulls are warranted for one (1) year against structural defects in materials and workmanship. This warranty does not include the surface finish or any damage due to misuse, negligence or ordinary wear. This warranty is cancelled, if the boat is operated with an outboard motor which exceeds the maximum horsepower rating, listed on the serial plate attached to the transom.

E. Aluminum RIB's: The aluminium hulls for non commercial use are warranted for five (5) years against structural defects in materials and workmanship (only for models 2015 and up). This warranty does not include the surface finish or any damage due to misuse, negligence or ordinary wear. This warranty is cancelled if the boat is operated with an outboard motor which exceeds the maximum horsepower rating listed on the serial plate attached to the transom. Although we only use marine grade aluminum of the best manufacture, corrosion is not covered under our warranty. After every use, it is recommended to wash the boat with fresh water in order to avoid any build up. We also recommend that scratches and dents are repaired as soon as they occur.

H. Accessories: The oars, handles, seats, rings, moorings, cushions, steering system and cables, hydraulic hoses and fittings, fuel systems, associated hoses, fittings, tanks, hardware and electrical cables, are warranted for one (1) year against defects in material and workmanship, with the exception of bilge pumps and water pumps. This warranty does not include any painted or finished surfaces.

2. What is not Covered This limited Warranty shall not apply to:

- A.** Any minor boat damage, including but not limited to gelcoat grazing or blistering.
- B.** Any damage to AB inflatable boat due to negligence, accident, misuse, alteration, improper operation, improper tailoring, collision, fire, theft, vandalism, riot, explosion, or objects striking the boat, use of an outboard motor in excess of the maximum horsepower listed on the data plate fastened to the transom, or improper maintenance or storage.
- C.** Any damage resulting from towing AB inflatable boat, or any damage resulting from lifting an AB inflatable boat, except when the lifting eyes attached to the inflatable boat are properly utilized in connection with an AB approved lifting harness.
- D.** Tubes exposed to harsh or corrosive chemicals.
- E.** Parts installed by anyone other than AB DISTRIBUTOR authorized personnel.
- F.** Any damage caused by aftermarket parts.
- G.** AB Inflatables boats purchased for racing or in other competitive events as well as charter, rental, commercial or governmental use.
- H.** Any work done on an AB inflatable boat at an unauthorized service station and/or without AB DISTRIBUTOR prior approval, will void the remainder of the warranty for that product.
- I.** Freight, delivery, storage or other similar charges.
- J.** Equipment installed on AB inflatable boat (such as electronics) carries their own individual warranties provided by their respective manufacturers. In such

cases, any warranty claims regarding those parts must be directed to those manufactures and not AB DISTRIBUTOR.

K. AB inflatable boat which is used in a manner contrary to the directions or instructions indicated in the AB Inflatables Owner's Manual.

3. Commercial:Warranty for any AB inflatable boat purchased for commercial and/or governmental use will be covered as follows:

A. Fabric: The Chlorosulfonated Polyethylene (CSM) coated fabric of the tubes is warranted for a period of one (1) years against porosity deterioration affecting serviceability. This warranty does not include discoloration, puncture, fading, tearing, ripping, cracking, abrasion, chaffing, negligence, accident or ordinary wear and tear.

B. Seams: The air holding seams of the inflatable tube are warranted for one (1) year against separation and subsequent loss of air, which exceeds twenty percent (20%) of recommended inflation pressure when measured over a period of five (5) days, while maintaining the boat at a constant temperature in a controlled environment. The major cause of damage is the result of running the boat underinflated. The owner is expected to check and properly maintain the correct inflation pressure before using the boat, or when temperature variations have exceeded ten degrees Celsius (10°C) or fifty degrees Fahrenheit (50°F) since inflation, or when running under unusual operation conditions.

C. Fiberglass hull:The composite of fiberglass hulls are warranted for one (1) year against structural defects in materials and workmanship. This warranty does not include the surface finish or any damage due to misuse, negligence or ordinary wear. This warranty is cancelled, if the boat is operated with an outboard motor which exceeds the maximum horsepower rating, listed on the serial plate attached to the transom.

D. Aluminum RIBs: The aluminum hulls are warranted for one (1) year against structural defects in materials and workmanship. This warranty does not include the surface finish or any damage due to misuse, negligence or ordinary wear. This warranty is cancelled, if the boat is operated with an outboard motor which exceeds the maximum horsepower rating, listed on the serial plate attached to the transom. Although we only use marine grade aluminum of the best manufacture, corrosion is not covered under our warranty. After every use, it is recommended to wash the boat with fresh water in order to avoid any build up. We also recommend that scratches and dents are repaired as soon as they occur.

E. Accessories: The oars, handles, seats, rings, moorings, cushions, steering systems and cables, hydraulic hoses and fittings, fuel systems, associated hoses, fittings, tanks, hardware, electrical cables, switches and fuse panels are warranted for one hundred and twenty (120) days against defects in material and workmanship, with the exception of bilge pumps and water pumps. This warranty does not include any painted or finished surfaces.

4. Transferability.

This warranty is transferable to another owner within one (1) year of original effective date of sale; provided that an original warranty card is on file with THE AB DISTRIBUTOR and that the new holder of the warranty provides proof, to the satisfaction of THE AB DISTRIBUTOR, that the owner has purchased another AB inflatable boat. The warranty transferred to a new owner is prorated in time with respect to the time of original purchase.

5. Effective Date and Conditions.

This warranty shall become effective on the date of sale provided that the warranty registration card is properly completed and mailed by the retail purchaser and received by the AB DISTRIBUTOR, within fifteen (15) days from date of purchase.

6. Miscellaneous:

This warranty shall not apply if the AB inflatable boat is subject to negligence, accident, improper operation or trailering, improper maintenance or storage, commercial or abnormal use or application, or to damage by circumstances beyond AB DISTRIBUTOR control, including but not limited to, puncture, tearing, ripping, abrasion, ordinary wear and tear. This warranty applies only to those parts and components manufactured by AB and installed by factory personnel.

THIS WARRANTY IS EXCLUSIVE AND IN LIEU OF ALL OTHER EXPRESSED OR IMPLIED WARRANTIES, THIS WARRANTY EXPRESSLY EXCLUDES IMPLIED WARRANTIES, INCLUDING, BUT NOT LIMITED TO, THE IMPLIED WARRANTY OF MERCHANTABILITY OR FITNESS FOR A PARTICULAR USE, EXCEPT AS SPECIFICALLY SET FORTH WITHIN THIS WARRANTY. AB DISTRIBUTOR SOLE OBLIGATION, AND YOUR EXCLUSIVE REMEDY UNDER THIS WARRANTY, IS LIMITED TO REPAIR OR REPLACEMENT, AT AB DISTRIBUTOR OPTION, FOR PARTS FOUND TO BE DEFECTIVE. IN THE EVENT EXACT REPLACEMENT PARTS OR BOATS ARE NOT AVAILABLE AT THE TIME OF THE WARRANTY CLAIM, AB DISTRIBUTOR MAY SUBSTITUTE PARTS OR BOATS OF THE SAME OR BETTER QUALITY AND THE CUSTOMER HEREBY AGREES TO ACCEPT SUCH REPLACEMENT IN SATISFACTION OF THE WARRANTY SET FORTH HEREIN. AB DISTRIBUTOR SHALL NOT BE LIABLE FOR ANY CONSEQUENTIAL, INCIDENTAL OR CONTINGENT DAMAGES WHATSOEVER, SOME STATES DO NOT ALLOW (A) LIMITATIONS ON HOW LONG APPLIED WARRANTIES LAST, OR (B) THE EXCLUSION OR LIMITATION OF INCIDENTAL OR CONSEQUENTIAL DAMAGES, SO THE ABOVE LIMITATION OR EXCLUSIONS MAY NOT APPLY TO YOU. THIS WARRANTY GIVES YOU SPECIFIC LEGAL RIGHTS, AND YOU MAY ALSO HAVE OTHER RIGHTS, WHICH VARY, FROM STATE TO STATE.

All warranty claims must be made through an authorized AB repair station within thirty (30) days of discovery of defect and submitted on the warranty claim form available from the dealer together with proof of purchase. Photographs illustrating damage, if any, must accompany the claim. An authorized AB DISTRIBUTOR representative may make an inspection within a reasonable time after receipt of the claim. Freight and transport charges, where applicable, incurred in shipping a boat to be repaired or replaced, are to be paid by consumer purchaser. AB DISTRIBUTOR reserves the right to make changes in the

design and materials of its inflatable boats without incurring any obligation to incorporate such changes in units already completed or in hands of dealers or consumers. The entire obligation of AB DISTRIBUTOR regarding the sale of its inflatable boats is stated within this warranty. AB DISTRIBUTOR does not authorize its dealers, repair stations or any other person to assume for it any other liability in connection with the sale of its inflatable boats, the Federal Safety Act of 1971 provides for defect notification to the first purchaser. Failure to register your purchase with the manufacturer constitutes waiver of the right to defect notification. Demand that the dealer completes your own registration form and send it to the manufacturer. If you are unable to locate an authorized AB dealer please contact: AB Inflatables at info@abinflatables.com.

Notes
